

Learn the Java skills you will need to start  
developing Android apps



Learn  
**Java for Android  
Development**

**THIRD EDITION**

**Jeff Friesen**

**Apress®**

[www.it-ebooks.info](http://www.it-ebooks.info)



*For your convenience Apress has placed some of the front matter material after the index. Please use the Bookmarks and Contents at a Glance links to access them.*



---

# Contents at a Glance

<b>About the Author .....</b>	<b>xxi</b>
<b>About the Technical Reviewer .....</b>	<b>xxiii</b>
<b>Acknowledgments .....</b>	<b>xxv</b>
<b>Introduction .....</b>	<b>xxvii</b>
<b>■ Chapter 1: Getting Started with Java .....</b>	<b>1</b>
<b>■ Chapter 2: Learning Language Fundamentals .....</b>	<b>31</b>
<b>■ Chapter 3: Discovering Classes and Objects .....</b>	<b>89</b>
<b>■ Chapter 4: Discovering Inheritance, Polymorphism, and Interfaces .....</b>	<b>141</b>
<b>■ Chapter 5: Mastering Advanced Language Features, Part 1 .....</b>	<b>189</b>
<b>■ Chapter 6: Mastering Advanced Language Features, Part 2 .....</b>	<b>235</b>
<b>■ Chapter 7: Exploring the Basic APIs, Part 1 .....</b>	<b>287</b>
<b>■ Chapter 8: Exploring the Basic APIs, Part 2 .....</b>	<b>359</b>
<b>■ Chapter 9: Exploring the Collections Framework .....</b>	<b>401</b>
<b>■ Chapter 10: Exploring the Concurrency Utilities.....</b>	<b>487</b>
<b>■ Chapter 11: Performing Classic I/O .....</b>	<b>539</b>
<b>■ Chapter 12: Accessing Networks .....</b>	<b>621</b>

■ Chapter 13: Migrating to New I/O.....	665
■ Chapter 14: Accessing Databases .....	763
■ Chapter 15: Parsing, Creating, and Transforming XML Documents.....	803
■ Chapter 16: Focusing on Odds and Ends .....	885
■ Appendix A: Solutions to Exercises .....	1015
■ Appendix B: Four of a Kind .....	1127
Index.....	1149

---

# Introduction

Smartphones and tablets are all the rage these days. Their popularity is largely due to their ability to run apps. Although the iPhone and iPad, with their growing collection of Objective-C based apps, had a head start, Android-based smartphones and tablets, with their growing collection of Java-based apps, have proven to be a strong competitor.

Not only are many iPhone/iPad app developers making money by selling their apps, but many Android app developers are also making money by selling similar apps. According to tech web sites such as The Register ([www.theregister.co.uk](http://www.theregister.co.uk)), some Android app developers are making lots of money ([www.theregister.co.uk/2010/03/02/android\\_app\\_profit](http://www.theregister.co.uk/2010/03/02/android_app_profit)).

In today's challenging economic climate, you might like to try your hand at developing Android apps and make some money. If you have good ideas, perseverance, and some artistic talent (or perhaps know some talented individuals), you are already part of the way toward achieving this goal.

**Tip** A good reason to consider Android app development over iPhone/iPad app development is the lower startup costs that you'll incur with Android. For example, you don't need to purchase a Mac on which to develop Android apps (a Mac is required for developing iPhone/iPad apps); your existing Windows, Linux, or Unix machine will do nicely.

Most importantly, you'll need to possess a solid understanding of the Java language and foundational application programming interfaces (APIs) before jumping into Android. After all, Android apps are written in Java and interact with many of the standard Java APIs (such as threading and input/output APIs).

I wrote *Learn Java for Android Development* to give you a solid Java foundation that you can later extend with knowledge of Android architecture, API, and tool specifics. This book will give you a strong grasp of the Java language and the many important APIs that are fundamental to Android apps and other Java applications. It will also introduce you to key development tools.

## Book Organization

The first edition of this book was organized into 10 chapters and 1 appendix. The second edition was organized into 14 chapters and 3 appendixes. This third edition is organized into 16 chapters and 2 appendixes with a bonus appendix on Android app development. Each chapter in each edition offers a set of exercises that you should complete to get the most benefit from its content. Their solutions are presented in Appendix A.

Chapter 1 introduces you to Java by first focusing on Java's dual nature (language and platform). It then briefly introduces you to Oracle's Java SE, Java EE, and Java ME editions of the Java platform. You next learn how to download and install the Java SE Development Kit (JDK), and you learn some Java basics by developing and playing with three simple Java applications. After receiving a brief introduction to the Eclipse IDE, you receive a brief introduction to Android.

Chapter 2 starts you on an in-depth journey of the Java language by focusing on language fundamentals. You first learn about simple application structure and then learn about comments, identifiers (and reserved words), types, variables, expressions (and literals), and statements.

Chapter 3 continues your journey by focusing on classes and objects. You learn how to declare a class and organize applications around multiple classes. You then learn how to construct objects from classes, declare fields in classes and access these fields, declare methods in classes and call them, initialize classes and objects, and remove objects when they're no longer needed. You also learn more about arrays, which were first introduced in Chapter 2.

Chapter 4 adds to Chapter 3's pool of object-based knowledge by introducing you to the language features that take you from object-based applications to object-oriented applications. Specifically, you learn about features related to inheritance, polymorphism, and interfaces. While exploring inheritance, you learn about Java's ultimate superclass. Also, while exploring interfaces, you discover why they were included in the Java language; interfaces are not merely a workaround for Java's lack of support for multiple implementation inheritance, but serve a higher purpose.

Chapter 5 introduces you to four categories of advanced language features: nested types, packages, static imports, and exceptions.

Chapter 6 introduces you to four additional advanced language feature categories: assertions, annotations, generics, and enums.

Chapter 7 begins a trend that focuses more on APIs than language features. This chapter first introduces you to Java's Math and StrictMath math-oriented types. It then explores Number and its various subtypes (such as Integer, Double, and BigDecimal). Next you explore the string-oriented types (String, StringBuffer, and StringBuilder) followed by the System type. Finally, you explore the Thread class and related types for creating multithreaded applications.

Chapter 8 continues to explore Java's basic APIs by focusing on the Random class for generating random numbers; the References API, Reflection, the StringTokenizer class for breaking a string into smaller components; and the Timer and TimerTask classes for occasionally or repeatedly executing tasks.

Chapter 9 focuses exclusively on Java's Collections Framework, which provides you with a solution for organizing objects in lists, sets, queues, and maps. You also learn about collection-oriented utility classes and review Java's legacy collection types.

Chapter 10 focuses exclusively on Java's Concurrency Utilities. After receiving an introduction to this framework, you explore executors, synchronizers (such as countdown latches), concurrent collections, the Locking Framework, and atomic variables (where you discover compare-and-swap).

Chapter 11 is all about classic input/output (I/O), largely from a file perspective. In this chapter, you explore classic I/O in terms of the `File` class, `RandomAccessFile` class, various stream classes, and various writer/reader classes. My discussion of stream I/O includes coverage of Java's object serialization and deserialization mechanisms.

Chapter 12 continues to explore classic I/O by focusing on networks. You learn about the `Socket`, `ServerSocket`, `DatagramSocket`, and `MulticastSocket` classes along with related types. You also learn about the `URL` class for achieving networked I/O at a higher level and learn about the related `URI` class. After learning about the low-level `NetworkInterface` and `InterfaceAddress` classes, you explore cookie management, in terms of the `CookieHandler` and `CookieManager` classes, and the `CookiePolicy` and `CookieStore` interfaces.

Chapter 13 introduces you to New I/O. You learn about buffers, channels, selectors, regular expressions, charsets, and the `Formatter` and `Scanner` types in this chapter.

Chapter 14 focuses on databases. You first learn about the Java DB and SQLite database products, and then explore JDBC for communicating with databases created via these products.

Chapter 15 emphasizes Java's support for XML. I first provide a tutorial on this topic where you learn about the XML declaration, elements and attributes, character references and CDATA sections, namespaces, comments and processing instructions, well-formed documents, and valid documents (in terms of Document Type Definition and XML Schema). I then show you how to parse XML documents via the SAX API, parse and create XML documents via the DOM API, parse XML documents via the XMLPULL V1 API (supported by Android as an alternative to Java's StAX API), use the XPath API to concisely select nodes via location path expressions, and transform XML documents via XSLT.

Chapter 16 completes the chapter portion of this book by covering odds and ends. You first learn about useful Java 7 language features that I've successfully used in Android apps. Next, you explore classloaders, the `Console` class, design patterns (with emphasis on the Strategy pattern), double brace initialization, fluent interfaces, immutability, internationalization (in terms of locales; resource bundles; break iterators; collators; dates, time zones, and calendars; and formatters), the Logging API, the Preferences API, the `Runtime` and `Process` classes, the Java Native Interface, and the ZIP and JAR APIs.

Appendix A presents solutions to all of the exercises in Chapters 1 through 16.

Appendix B introduces you to application development in the context of *Four of a Kind*, a console-based card game.

Appendix C provides an introduction to Android app development. It gives you a chance to see how various Java language features and APIs are used in an Android context.

Unlike the other elements, Appendix C is not included in this book—it's included with the book's source code. Appendix C doesn't officially belong in *Learn Java for Android Development* because this book's focus is to prepare you for getting into Android app development by teaching you the fundamentals of the Java language, and Appendix C goes beyond that focus by giving you a tutorial on Android app development. Besides, the presence of this appendix would cause the book to exceed the 1,200-page print-on-demand limit.

**Note** You can download this book's source code by pointing your web browser to [www.apress.com/9781430264545](http://www.apress.com/9781430264545) and clicking the Source Code tab followed by the Download Now link.

## What Comes Next?

After you complete this book, I recommend that you check out Apress's other Android-oriented books, such as *Beginning Android 4* by Grant Allen (Apress, 2012), and learn more about developing Android apps. In that book, you learn Android basics and how to create "innovative and salable applications for Android 4 mobile devices."

Thanks for purchasing this third (and my final) edition of *Learn Java for Android Development*. I hope you find it a helpful preparation for, and I wish you lots of success in achieving, a satisfying and lucrative career as an Android app developer.

—Jeff Friesen, January 2014



# Getting Started with Java

Android apps are written in Java and use various Java application program interfaces (APIs). Because you'll want to write your own apps, but may be unfamiliar with the Java language and these APIs, this book teaches you about Java as a first step into Android app development. It provides you with Java language fundamentals and Java APIs that are useful when developing apps.

**Note** This book illustrates Java concepts via non-Android Java applications. It's easier for beginners to grasp these applications than corresponding Android apps. However, I also reveal a trivial Android app toward the end of this chapter for comparison purposes.

An *API* is an interface that application code uses to communicate with other code, which is typically stored in a software library. For more information on this term, check out Wikipedia's "Application programming interface" topic at [http://en.wikipedia.org/wiki/Application\\_programming\\_interface](http://en.wikipedia.org/wiki/Application_programming_interface).

This chapter sets the stage for teaching you the essential Java concepts that you need to understand before embarking on an Android app development career. I first answer the question: "What is Java?" Next, I show you how to install the Java SE Development Kit (JDK) and introduce you to JDK tools for compiling and running Java applications.

After presenting a few simple example applications, I show you how to install and use the open source Eclipse IDE (integrated development environment) so that you can more easily (and more quickly) develop Java applications and (eventually) Android apps. I then provide you with a brief introduction to Android and show you how Java fits into the Android development paradigm.

## What Is Java?

*Java* is a language and a platform originated by Sun Microsystems. In this section, I briefly describe this language and reveal what it means for Java to be a platform. To meet various needs, Sun organized Java into three main editions: Java SE, Java EE, and Java ME. This section briefly explores each of these editions.

**Note** Java has an interesting history that dates back to December 1990. At that time, James Gosling, Patrick Naughton, and Mike Sheridan (all employees of Sun Microsystems) were given the task of figuring out the next major trend in computing. They concluded that one trend would involve the convergence of computing devices and intelligent consumer appliances. Thus was born the *Green Project*.

The fruits of Green were *Star7*, a handheld wireless device featuring a five-inch color LCD screen, a SPARC processor, a sophisticated graphics capability, a version of Unix, and *Oak*, a language developed by James Gosling for writing applications to run on Star7 that he named after an oak tree growing outside of his office window at Sun. To avoid a conflict with another language of the same name, Dr. Gosling changed this language's name to Java.

Sun Microsystems subsequently evolved the Java language and platform until Oracle acquired Sun in early 2010. Check out <http://oracle.com/technetwork/java/index.html> for the latest Java news from Oracle.

## Java Is a Language

Java is a language in which developers express *source code* (program text). Java's *syntax* (rules for combining symbols into language features) is partly patterned after the C and C++ languages in order to shorten the learning curve for C/C++ developers.

The following list identifies a few similarities between Java and C/C++:

- Java and C/C++ share the same single-line and multi-line comment styles. Comments let you document source code.
- Many of Java's reserved words are identical to their C/C++ counterparts (*for*, *if*, *switch*, and *while* are examples) and C++ counterparts (*catch*, *class*, *public*, and *try* are examples).
- Java supports character, double precision floating-point, floating-point, integer, long integer, and short integer primitive types via the same *char*, *double*, *float*, *int*, *long*, and *short* reserved words.
- Java supports many of the same operators, including arithmetic (+, -, \*, /, and %) and conditional (?:) operators.
- Java uses brace characters ({ and }) to delimit blocks of statements.

The following list identifies a few of the differences between Java and C/C++:

- Java supports an additional comment style known as Javadoc.
- Java provides reserved words not found in C/C++ (extends, strictfp, synchronized, and transient are examples).
- Java doesn't require machine-specific knowledge. It supports the byte integer type (see [http://en.wikipedia.org/wiki/Integer\\_\(computer\\_science\)](http://en.wikipedia.org/wiki/Integer_(computer_science))), doesn't provide a signed version of the character type, and doesn't provide unsigned versions of integer, long integer, and short integer. Furthermore, all of Java's primitive types have guaranteed implementation sizes, which is an important part of achieving portability (discussed later). The same cannot be said of equivalent primitive types in C and C++.
- Java provides operators not found in C/C++. These operators include instanceof and >>> (unsigned right shift).
- Java provides labeled break and continue statements that you'll not find in C/C++.

You'll learn about single-line, multi-line, and Javadoc comments in Chapter 2. Also, you'll learn about reserved words, primitive types, operators, blocks, and statements (including labeled break and labeled continue) in that chapter.

Java was designed to be a safer language than C/C++. It achieves safety in part by not letting you overload operators and by omitting C/C++ features such as *pointers* (storage locations containing addresses; see [http://en.wikipedia.org/wiki/Pointer\\_\(computer\\_programming\)](http://en.wikipedia.org/wiki/Pointer_(computer_programming))).

Java also achieves safety by modifying certain C/C++ features. For example, loops must be controlled by Boolean expressions instead of integer expressions where 0 is false and a nonzero value is true. (There is a discussion of loops and expressions in Chapter 2.)

Suppose you must code a C/C++ while loop that repeats no more than 10 times. Being tired, you specify the following:

```
while (x)
    x++;
```

Assume that *x* is an integer-based variable initialized to 0 (I discuss variables in Chapter 2). This loop repeatedly executes *x++* to add 1 to *x*'s value. This loop doesn't stop when *x* reaches 10; you have introduced a bug.

This problem is less likely to occur in Java because it complains when it sees `while (x)`.

This complaint requires you to recheck your expression, and you will then most likely specify `while (x != 10)`. Not only is safety improved (you cannot specify just *x*), but meaning is also clarified: `while (x != 10)` is more meaningful than `while (x)`.

These and other fundamental language features support classes, objects, inheritance, polymorphism, and interfaces. Java also provides advanced features related to nested types, packages, static imports, exceptions, assertions, annotations, generics, enums, and more. Subsequent chapters explore most of these language features.

## Java Is a Platform

Java is a platform consisting of a virtual machine and an execution environment. The *virtual machine* is a software-based processor that presents an instruction set, and it is commonly referred to as the *Java Virtual Machine (JVM)*. The *execution environment* consists of libraries for running programs and interacting with the underlying operating system (also known as the *native platform*).

The execution environment includes a huge library of prebuilt classfiles that perform common tasks, such as math operations (trigonometry, for example) and network communications. This library is commonly referred to as the *standard class library*.

A special Java program known as the *Java compiler* translates source code into *object code* consisting of instructions that are executed by the JVM and associated data. These instructions are known as *bytecode*. Figure 1-1 shows this translation process.

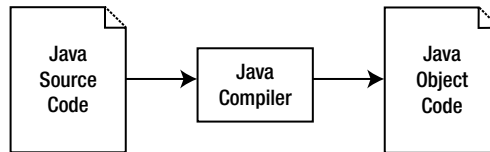

**Figure 1-1.** The Java compiler translates Java source code into Java object code consisting of bytecode and associated data

The compiler stores a program's bytecode and data in files having the `.class` extension. These files are known as *classfiles* because they typically store the compiled equivalent of classes, a language feature discussed in Chapter 3. Figure 1-2 shows the organization of a classfile.

Magic Number
Version Number
Constant Pool
Access Flags
This Class
Superclass
Interfaces
Fields
Methods
Class/Interface Attributes

**Figure 1-2.** A classfile is organized into a magic number, version number, constant pool, and seven other sections

Don't worry about having to know this classfile architecture. I present it to satisfy the curiosities of those who are interested in learning more about how classfiles are organized.

A Java program executes via a tool that loads and starts the JVM and passes the program's main classfile to the machine. The JVM uses its *classloader* component to load the classfile into memory.

After the classfile has been loaded, the JVM's *bytecode verifier* component makes sure that the classfile's bytecode is valid and doesn't compromise security. The verifier terminates the JVM when it finds a problem with the bytecode.

Assuming that all is well with the classfile's bytecode, the JVM's *interpreter* component interprets the bytecode one instruction at a time. *Interpretation* consists of identifying bytecode instructions and executing equivalent native instructions.

**Note** *Native instructions* (also known as *native code*) are the instructions understood by the native platform's physical processor.

When the interpreter learns that a sequence of bytecode instructions is executed repeatedly, it informs the JVM's *just-in-time (JIT) compiler* to compile these instructions into native code.

JIT compilation is performed only once for a given sequence of bytecode instructions. Because the native instructions execute instead of the associated bytecode instruction sequence, the program executes much faster.

During execution, the interpreter might encounter a request to execute another classfile's bytecode. When that happens, it asks the classloader to load the classfile and the bytecode verifier to verify the bytecode before executing that bytecode.

Also during execution, bytecode instructions might request that the JVM open a file, display something on the screen, or perform another task that requires cooperation with the native platform. The JVM responds by transferring the request to the platform via its *Java Native Interface (JNI)* bridge to the native platform. Figure 1-3 shows these JVM tasks.

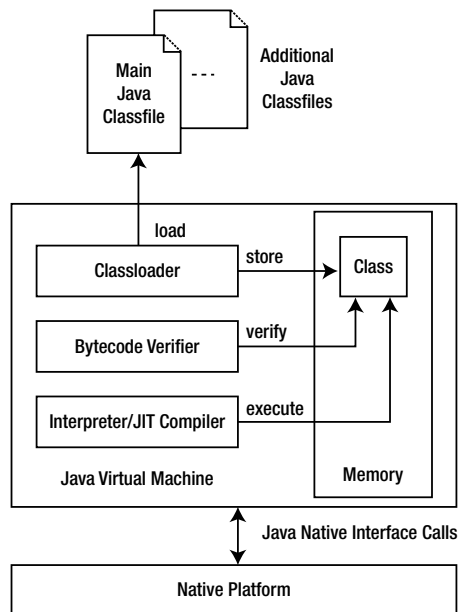

**Figure 1-3.** The JVM provides all of the necessary components for loading, verifying, and executing a classfile

The platform side of Java promotes *portability* by providing an abstraction over the underlying platform. As a result, the same bytecode runs unchanged on Windows, Linux, Mac OS X, and other platforms.

**Note** Java was introduced with the slogan “write once, run anywhere.” Although Java goes to great lengths to enforce portability (such as defining an integer always to be 32 binary digits [bits] and a long integer always to be 64 bits (see <http://en.wikipedia.org/wiki/Bit> to learn about binary digits), it doesn't always succeed. For example, despite being mostly platform independent, certain parts of Java (such as the scheduling of threads, discussed in Chapter 7) vary from underlying platform to underlying platform.

The platform side of Java also promotes *security* by doing its best to provide a secure environment (such as the bytecode verifier) in which code executes. The goal is to prevent malicious code from corrupting the underlying platform (and possibly stealing sensitive information).

**Note** Many security issues that have plagued Java have prompted Oracle to release various security updates. For example, blogger Brian Krebs reported on a recent update (at time of this writing) that fixes 51 security issues in his “Critical Java Update Plugs 51 Security Holes” blog post (<http://krebsonsecurity.com/2013/10/java-update-plugs-51-security-holes/>). Although troubling, Oracle is keeping on top of this ongoing problem (whose impact on Android is minimal).

## Java SE, Java EE, and Java ME

Developers use different editions of the Java platform to create Java programs that run on desktop computers, web browsers, web servers, mobile information devices (such as feature phones), and embedded devices (such as television set-top boxes).

- *Java Platform, Standard Edition (Java SE)*: The Java platform for developing *applications*, which are stand-alone programs that run on desktops. Java SE is also used to develop *applets*, which are programs that run in web browsers.
- *Java Platform, Enterprise Edition (Java EE)*: The Java platform for developing enterprise-oriented applications and *servlets*, which are server programs that conform to Java EE's Servlet API. Java EE is built on top of Java SE.
- *Java Platform, Micro Edition (Java ME)*: The Java platform for developing *MIDlets*, which are programs that run on mobile information devices, and *Xlets*, which are programs that run on embedded devices.

This book largely focuses on Java SE and applications.

**Note** Oracle is also championing *Java Embedded*, a collection of technologies that brings Java to all kinds of devices (such as smartcards and vehicle navigation systems). Java SE Embedded and Java ME Embedded are the two major subsets of Java Embedded.

## Installing the JDK and Exploring Example Applications

The *Java Runtime Environment (JRE)* implements the Java SE platform and makes it possible to run Java programs. The public JRE can be downloaded from Oracle's Java SE Downloads page at [www.oracle.com/technetwork/java/javase/downloads/index.html](http://www.oracle.com/technetwork/java/javase/downloads/index.html).

However, the public JRE doesn't make it possible to develop Java (and Android) applications. You need to download and install the *Java SE Development Kit (JDK)*, which contains development tools (including the Java compiler) and a private JRE.

**Note** JDK 1.0 was the first JDK to be released (in May 1995). Until JDK 6 arrived, JDK stood for Java Development Kit (SE wasn't part of the title). Over the years, numerous JDKs have been released, with JDK 7 being current at time of this writing.

Each JDK's version number identifies a version of Java. For example, JDK 1.0 identifies Java 1.0, and JDK 5 identifies Java 5.0. JDK 5 was the first JDK also to provide an internal version number: 1.5.0.

The Java SE Downloads page also provides access to the current JDK, which is JDK 7 Update 45 at time of this writing. Click the appropriate Download button to download the current JDK's installer application for your platform. Then run this application to install the JDK.

The JDK installer places the JDK in a home directory. (It can also install the public JRE in another directory.) On my Windows 7 platform, the home directory is C:\Program Files\Java\jdk1.7.0\_06. (I currently use JDK 7 Update 6—I'm slow to upgrade.)

**Tip** After installing the JDK, you should add the bin subdirectory to your platform's PATH environment variable (see <http://java.com/en/download/help/path.xml>) so that you can execute JDK tools from any directory. Also, you might want to create a projects subdirectory of the JDK's home directory to organize your Java projects and create a separate subdirectory within projects for each of these projects.

The home directory contains various files (such as `README.html`, which provides information about the JDK, and `src.zip`, which provides the standard class library source code) and subdirectories, including the following three important subdirectories:

- `bin`: This subdirectory contains assorted JDK tools. You'll use only a few of these tools in this book, mainly `javac` (Java compiler) and `java` (Java application launcher). However, you'll also work with `jar` (Java ARchive [JAR] creator, updater, and extractor—a *JAR file* is a ZIP file with special features), `javadoc` (Java documentation generator), and `serialver` (serial version inspector).
- `jre`: This subdirectory contains the JDK's private copy of the JRE, which lets you run Java programs without having to download and install the public JRE.
- `lib`: This subdirectory contains library files that are used by JDK tools. For example, `tools.jar` contains the Java compiler's classfiles. The compiler was written in Java.

**Note** `javac` isn't the Java compiler. It's a tool that loads and starts the JVM, identifies the compiler's main classfile (located in `tools.jar`) to the JVM, and passes the name of the source file being compiled to the compiler's main classfile.

You execute JDK tools at the *command line*, passing *command-line arguments* to a tool. For a quick refresher on the command line and command-line arguments topics, check out Wikipedia's "Command-line interface" entry ([http://en.wikipedia.org/wiki/Command-line\\_interface](http://en.wikipedia.org/wiki/Command-line_interface)).

The following command line shows you how to use `javac` to compile a source file named `App.java`:

```
javac App.java
```

The `.java` file extension is mandatory. The compiler complains when you omit this extension.

**Tip** You can compile multiple source files by specifying an asterisk in place of the filename, as follows:

```
javac *.java
```

Assuming success, an `App.class` file is created. If this file describes an application, which minimally consists of a single class containing a method named `main`, you can run the application as follows:

```
java App
```

You must not specify the `.class` file extension. The `java` tool complains when `.class` is specified.

In addition to downloading and installing the JDK, you'll need to access the JDK documentation, especially to explore the Java APIs. There are two sets of documentation that you can explore.



- Oracle's JDK 7 documentation (<http://docs.oracle.com/javase/7/docs/api/index.html>)
- Google's Java Android API documentation (<https://developer.android.com/reference/packages.html>)

Oracle's JDK 7 documentation presents many APIs that are not supported by Android. Furthermore, it doesn't cover APIs that are specific to Android. This book focuses only on core Oracle Java APIs that are also covered in Google's documentation.

## Hello, World!

It's customary to start exploring a new language and its tools by writing, compiling, and running a simple application that outputs the "Hello, World!" message. This practice dates back to Brian Kernighan's and Dennis Ritchie's seminal book, *The C Programming Language*.

Listing 1-1 presents the source code to a HelloWorld application that outputs this message.

### *Listing 1-1. Saying Hello in a Java Language Context*

```
public class HelloWorld
{
    public static void main(String[] args)
    {
        System.out.println("Hello, World!");
    }
}
```

This short seven-line application has a lot to say about the Java language. I'll briefly explain each feature, leaving comprehensive discussions of these features to later chapters.

This source code declares a *class*, which you can think of as a container for describing an application. The first line, `public class HelloWorld`, introduces the name of the class (HelloWorld), which is preceded by *reserved words* (names that have meaning to the Java compiler and which you cannot use to name other things in your programs) `public` and `class`. These reserved words respectively tell the compiler that HelloWorld must be stored in a file named HelloWorld and that a class is being declared.

The rest of the class declaration appears between a pair of brace characters (`{}`), which are familiar to C and C++ developers. Between these characters is the declaration of a *single method*, which you can think of as a named sequence of code. This method is named `main` to signify that it's the entry point into the application, and it is the analog of the `main()` function in C and C++.

The `main()` method includes a header that identifies this method and a block of code located between an open brace character (`{`) and a close brace character (`}`). Besides naming this method, the header provides the following information:

- `public`: This reserved word makes `main()` visible to the startup code that calls this method. If `public` wasn't present, the compiler would output an error message stating that it couldn't find a `main()` method.
- `static`: This reserved word causes this method to associate with the class instead of associating with any objects (discussed in Chapter 3) created from this class. Because the startup code that calls `main()` doesn't create an object from the class to call this method, it requires that the method be declared `static`. Although the compiler will not report an error when `static` is missing, it will not be possible to run `HelloWorld`, which will not be an application when the proper `main()` method doesn't exist.
- `void`: This reserved word indicates that the method doesn't return a value. If you change `void` to a type's reserved word (such as `int`) and then insert code that returns a value of this type (such as `return 0;`), the compiler will not report an error. However, you won't be able to run `HelloWorld` because the proper `main()` method wouldn't exist. (I discuss types in Chapter 2.)
- `(String[] args)`: This parameter list consists of a single parameter named `args`, which is of type `String[]`. Startup code passes a sequence of command-line arguments to `args`, which makes these arguments available to the code that executes within `main()`. You'll learn about parameters and arguments in Chapter 3.

`main()` is called with an array of *strings* (character sequences delimited by double quote " characters) that identify the application's command-line arguments. These strings are stored in `String`-based array variable `args`. (I discuss method calling, arrays, and variables in Chapters 2 and 3.) Although the array variable is named `args`, there's nothing special about this name. You could choose another name for this variable.

`main()` presents a single line of code, `System.out.println("Hello, World!");`, which is responsible for outputting `Hello, World!` in the command window from where `HelloWorld` is run. From left to right, this *method call* accomplishes the following tasks:

- `System` identifies a standard class of system utilities.
- `out` identifies an object variable located in `System` whose methods let you output values of various types optionally followed by a newline (also known as line feed) character to the standard output stream. (In reality, a platform-dependent line terminator sequence is output. On Windows platforms, this sequence consists of a carriage return character [integer value 13] followed by a line feed character [integer value 10]. On Linux platforms, this sequence consists of a line feed character. On Mac OS X systems, this sequence consists of a carriage return character. It's convenient to refer to this sequence as a newline.)
- `println` identifies a method that prints its `"Hello, World!"` argument (the starting and ending double quote characters are not written; these characters delimit but are not part of the string) followed by a newline to the standard output stream.

**Note** The standard output stream is part of *Standard I/O* ([http://en.wikipedia.org/wiki/Standard\\_streams](http://en.wikipedia.org/wiki/Standard_streams)), which also consists of standard input and standard error streams, and which originated with the Unix operating system. Standard I/O makes it possible to read text from different sources (keyboard or file) and write text to different destinations (screen or file).

Text is read from the standard input stream, which defaults to the keyboard but can be redirected to a file.

Text is written to the standard output stream, which defaults to the screen but can be redirected to a file.

Error message text is written to the standard error stream, which defaults to the screen but can be redirected to a file that differs from the standard output file.

Assuming that you're familiar with your platform's command-line interface and are at the command line, make HelloWorld your current directory and copy Listing 1-1 to a file named HelloWorld.java. Then compile this source file via the following command line:

```
javac HelloWorld.java
```

Assuming that you've included the .java extension, which is required by javac, and that HelloWorld.java compiles, you should discover a file named HelloWorld.class in the current directory. Run this application via the following command line:

```
java HelloWorld
```

If all goes well, you should see the following line of output on the screen:

```
Hello, World!
```

You can redirect this output to a file by specifying the greater than angle bracket (>) followed by a filename. For example, the following command line stores the output in a file named hello.txt:

```
java HelloWorld >hello.txt
```

## DumpArgs

In the previous example, I pointed out main()'s (String[] args) parameter list, which consists of a single parameter named args. This parameter stores an *array* (think sequence of values) of arguments passed to the application on the command line. Listing 1-2 presents the source code to a DumpArgs application that outputs each argument.

*Listing 1-2. Dumping Command-Line Arguments Stored in main()'s args Array to the Standard Output Stream*

```
public class DumpArgs
{
    public static void main(String[] args)
    {
        System.out.println("Passed arguments:");
        for (int i = 0; i < args.length; i++)
```

```
        System.out.println(args[i]);
    }
}
```

Listing 1-2's `DumpArgs` application consists of a class named `DumpArgs` that's very similar to Listing 1-1's `HelloWorld` class. The essential difference between these classes is the *for loop* (a construct for repeated execution and starting with reserved word `for`) that accesses each array item and dumps it to the standard output stream.

The `for` loop first initializes integer variable `i` to 0. This variable keeps track of how far the loop has progressed (the loop must end at some point), and it also identifies one of the entries in the `args` array. Next, `i` is compared with `args.length`, which records the number of entries in the array. The loop ends when `i`'s value equals the value of `args.length`. (I discuss `.length` in Chapter 2.)

Each loop iteration executes `System.out.println(args[i]);`. The string stored in the `i`th entry of the `args` array is accessed and then output to the standard output stream—the first entry is located at *index* (location) 0. The last entry is stored at index `args.length - 1`. Finally, `i` is incremented by 1 via `i++`, and `i < args.length` is reevaluated to determine whether the loop continues or ends.

Assuming that you're familiar with your platform's command-line interface and that you are at the command line, make `DumpArgs` your current directory and copy Listing 1-2 to a file named `DumpArgs.java`. Then compile this source file via the following command line:

```
javac DumpArgs.java
```

Assuming that that you've included the `.java` extension, which is required by `javac`, and that `DumpArgs.java` compiles, you should discover a file named `DumpArgs.class` in the current directory. Run this application via the following command line:

```
java DumpArgs
```

If all goes well, you should see the following line of output on the screen:

```
Passed arguments:
```

For more interesting output, you'll need to pass command-line arguments to `DumpArgs`. For example, execute the following command line, which specifies `Curly`, `Moe`, and `Larry` as three arguments to pass to `DumpArgs`:

```
java DumpArgs Curly Moe Larry
```

This time, you should see the following expanded output on the screen:

```
Passed arguments:
Curly
Moe
Larry
```

You can redirect this output to a file. For example, the following command line stores the DumpArgs application's output in a file named out.txt:

```
java DumpArgs Curly Moe Larry >out.txt
```

## EchoText

The previous two examples introduced you to a few Java language features, and they also showed outputting text to the standard output stream, which defaults to the screen but can be redirected to a file. In the final example (see Listing 1-3), I introduce more language features and demonstrate inputting text from the standard input stream and outputting text to the standard error stream.

*Listing 1-3. Echoing Text Read from Standard Input to Standard Output*

```
public class EchoText
{
    public static void main(String[] args)
    {
        boolean isRedirect = false;
        if (args.length != 0)
            isRedirect = true;
        int ch;
        try
        {
            while ((ch = System.in.read()) != ((isRedirect) ? -1 : '\n'))
                System.out.print((char) ch);
        }
        catch (java.io.IOException ioe)
        {
            System.err.println("I/O error");
        }
        System.out.println();
    }
}
```

EchoText is a more complex application than HelloWorld or DumpArgs. Its main() method first declares a Boolean (true/false) variable named isRedirect that tells this application whether input originates from the keyboard (isRedirect is false) or a file (isRedirect is true). The application defaults to assuming that input originates from the keyboard.

There's no easy way to determine if standard input has been redirected, and so the application requires that the user tell it if this is the case by specifying one or more command-line arguments. The *if decision* (a construct for making decisions and starting with reserved word if) evaluates args.length != 0, assigning true to isRedirect when this Boolean expression evaluates to true (at least one command-line argument has been specified).

main() now introduces the int variable ch to store the integer representation of each character read from standard input. (You'll learn about int and integer in Chapter 2.) It then enters a sequence of code prefixed by the reserved word try and surrounded by brace characters. Code within this block may throw an *exception* (an object describing a problem) and the subsequent catch block will handle it (to address the problem). (I discuss exceptions in Chapter 5.)

The try block consists of a *while loop* (a construct for repeated execution and starting with the reserved word `while`) that reads and echoes characters. The loop first calls `System.in.read()` to read a character and assign its integer value to `ch`. The loop ends when this value equals `-1` (no more input data is available from a file; standard input was redirected) or `'\n'` (the newline/line feed character has been read, which is the case when standard input wasn't redirected.) `'\n'` is an example of a character literal, which is discussed in Chapter 2.

For any other value in `ch`, this value is converted to a character via `(char)`, which is an example of Java's cast operator (discussed in Chapter 2). The character is then output via `System.out.print()`, which doesn't also terminate the current line by outputting a newline. The final `System.out.println()`; call terminates the current line without outputting any content.

When standard input is redirected to a file and `System.in.read()` is unable to read text from the file (perhaps the file is stored on a removable storage device that has been removed before the read operation), `System.in.read()` fails by throwing a `java.io.IOException` object that describes this problem. The code within the catch block is then executed, which outputs an I/O error message to the standard error stream via `System.err.println("I/O error");`.

**Note** `System.err` provides the same families of `println()` and `print()` methods as `System.out`. You should only switch from `System.out` to `System.err` when you need to output an error message so that the error messages are displayed on the screen, even when standard output is redirected to a file.

Compile Listing 1-3 via the following command line:

```
javac EchoText.java
```

Now run the application via the following command line:

```
java EchoText
```

You should see a flashing cursor. Type the following text and press Enter:

```
This is a test.
```

You should see this text duplicated on the following line and the application should end.

Continue by redirecting the input source to a file, by specifying the less than angle bracket (`<`) followed by a filename:

```
java EchoText <EchoText.java x
```

Although it looks like there are two command-line arguments, there is only one: `x`. (Redirection symbols followed by filenames don't count as command-line arguments.) You should observe the contents of `EchoText.java` listed on the screen.

Finally, execute the following command line:

```
java EchoText <EchoText.java
```

This time, `x` isn't specified, so input is assumed to originate from the keyboard. However, because the input is actually coming from the file `EchoText.java`, and because each line is terminated with a newline, only the first line from this file will be output.

**Note** If I had shortened the `while` loop expression to `while ((ch = System.in.read()) != -1)` and didn't redirect standard input to a file, the loop wouldn't end because `-1` would never be seen. To exit this loop, you would have to press the `Ctrl` and `C` keys simultaneously on a Windows platform or the equivalent keys on a non-Windows platform.

## Installing and Exploring the Eclipse IDE

Working with the JDK's tools at the command line is probably okay for small projects. However, this practice isn't recommended for large projects, which are hard to manage without the help of an IDE.

An *IDE* consists of a project manager for managing a project's files, a text editor for entering and editing source code, a debugger for locating bugs, and other features. Eclipse is a popular IDE that Google supports for developing Android apps.

**Note** For convenience, I use JDK tools throughout this book, except for this section where I discuss and demonstrate the Eclipse IDE.

*Eclipse IDE* is an open source IDE for developing programs in Java and other languages (such as C, COBOL, PHP, Perl, and Python). Eclipse Standard is one distribution of this IDE that's available for download; version 4.3.1 is the current version at time of this writing.

You should download and install Eclipse Standard to follow along with this section's Eclipse-oriented example. Begin by pointing your browser to [www.eclipse.org/downloads/](http://www.eclipse.org/downloads/) and completing the following tasks.

1. Scroll down the page until you see an Eclipse Standard entry. (It may refer to 4.3.1 or a newer version.)
2. Click one of the platform links (such as Windows 64 Bit) to the right of this entry.
3. Select a download mirror from the subsequently displayed page, and proceed to download the distribution's archive file.

I downloaded the `eclipse-standard-kepler-SR1-win32-x86_64.zip` archive file for my Windows 7 platform, unarchived this file, moved the resulting `eclipse` home directory to another location, and created a shortcut to that directory's `eclipse.exe` file.

After installing Eclipse Classic, run this application. You should discover a splash screen identifying this IDE and a dialog box that lets you choose the location of a workspace for storing projects followed by a main window like the one shown in Figure 1-4.

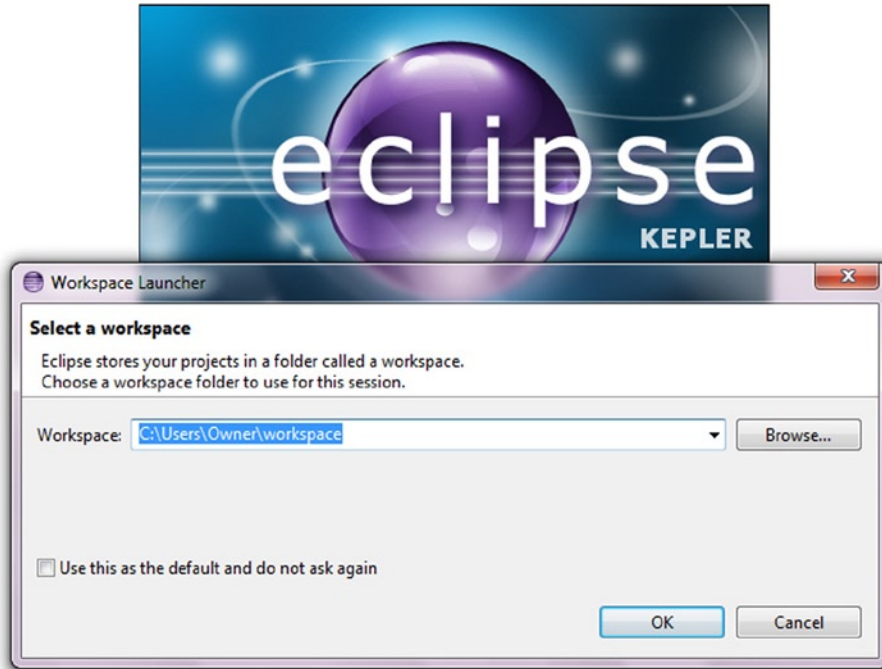

*Figure 1-4. Keep the default workspace or choose another workspace*

Click the OK button, and you're taken to Eclipse's main window. See Figure 1-5.

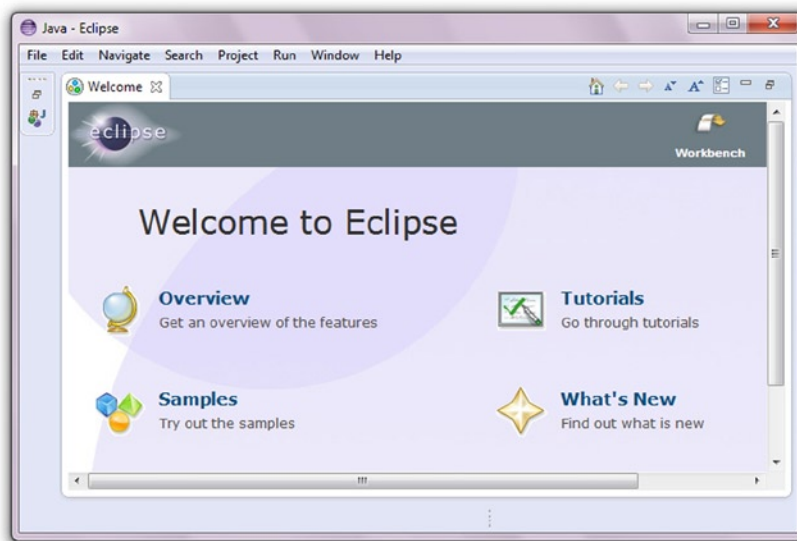

*Figure 1-5. The main window initially presents a Welcome tab*



The main window initially presents a Welcome tab from which you can learn more about Eclipse. Click this tab's X icon to close this tab; you can restore the Welcome tab by selecting Welcome from the menu bar's Help menu.

The Eclipse user interface is based on a main window that consists of a menu bar, a tool bar, a workbench area, and a status bar. The *workbench* presents windows for organizing Eclipse projects, editing source files, viewing messages, and more.

To help you get comfortable with the Eclipse user interface, I'll show you how to create a DumpArgs project containing a single DumpArgs.java source file with Listing 1-2's source code. You'll also learn how to compile and run this application.

Complete the following steps to create the DumpArgs project.

1. Select New from the File menu and Java Project from the resulting pop-up menu.
2. In the resulting New Java Project dialog box, enter **DumpArgs** into the Project name text field. Keep all of the other defaults, and click the Finish button.

After the second step (and after closing the Welcome tab), you'll see a workbench similar to the one shown in Figure 1-6.

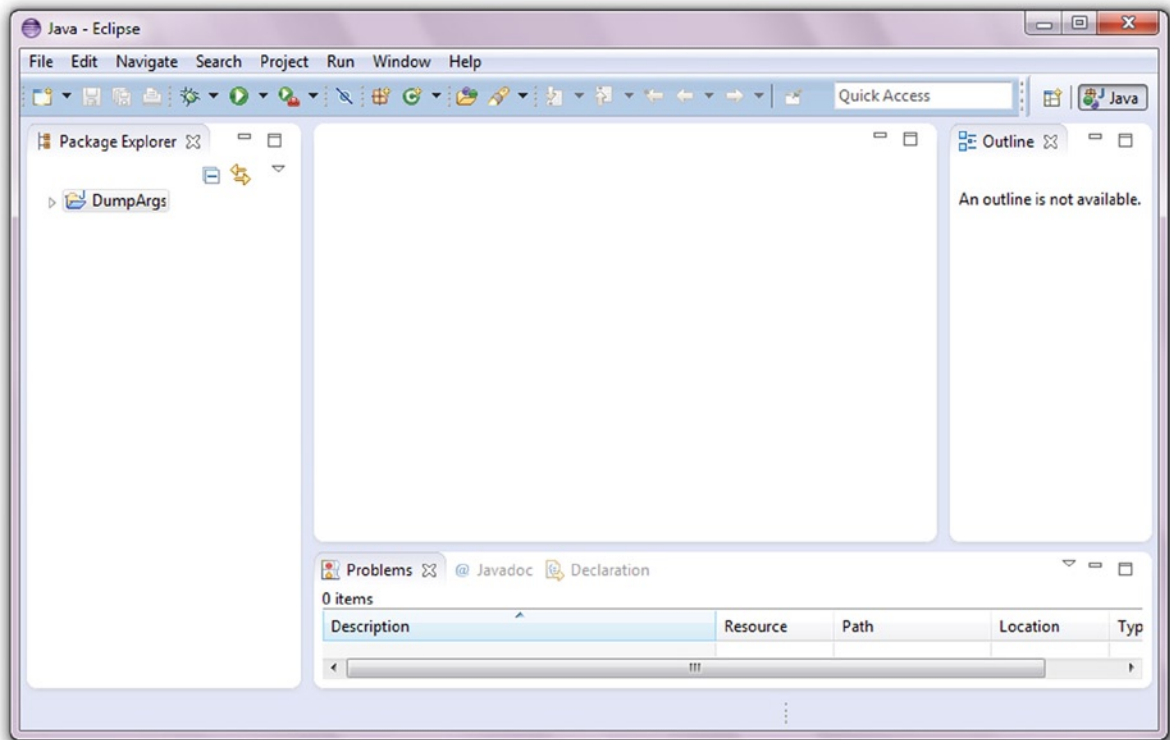

Figure 1-6. A DumpArgs entry appears in the workbench's Package Explorer

On the left side of the workbench, you'll see a window titled Package Explorer. This window identifies the workspace's projects in terms of packages (discussed in Chapter 5). At the moment, only a single DumpArgs entry appears in this window.

Clicking the triangle icon to the left of DumpArgs expands this entry to reveal src and JRE System Library items. The src item stores the DumpArgs project's source files, and the JRE System Library item identifies various JRE files that are used to run this application.

You'll now add a new file named DumpArgs.java to src.

1. Highlight src, and select New from the File menu and File from the resulting pop-up menu.
2. In the resulting New File dialog box, enter **DumpArgs.java** into the File name text field, and click the Finish button.

Eclipse responds by displaying an editor window titled DumpArgs.java. Copy Listing 1-2 content to this window. Then compile and run this application by selecting Run from the Run menu. (If you see a Save and Launch dialog box, click OK to close this dialog box.) Figure 1-7 shows the results.

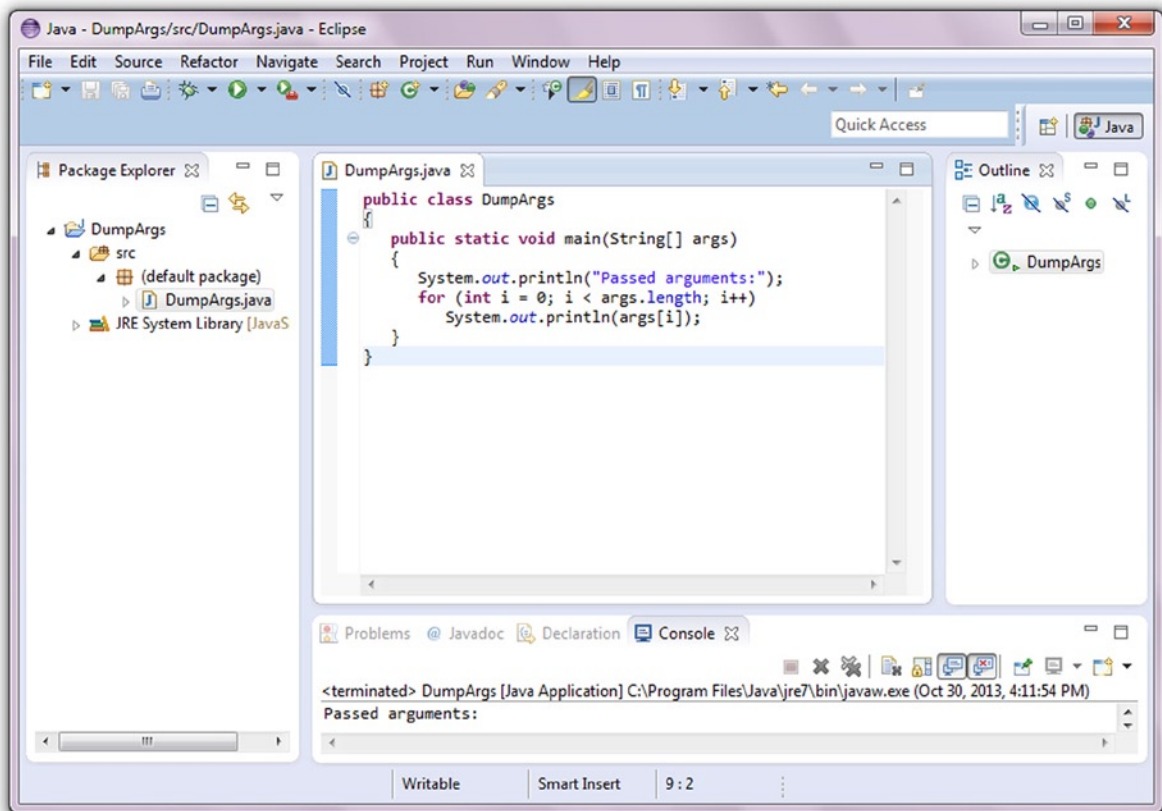
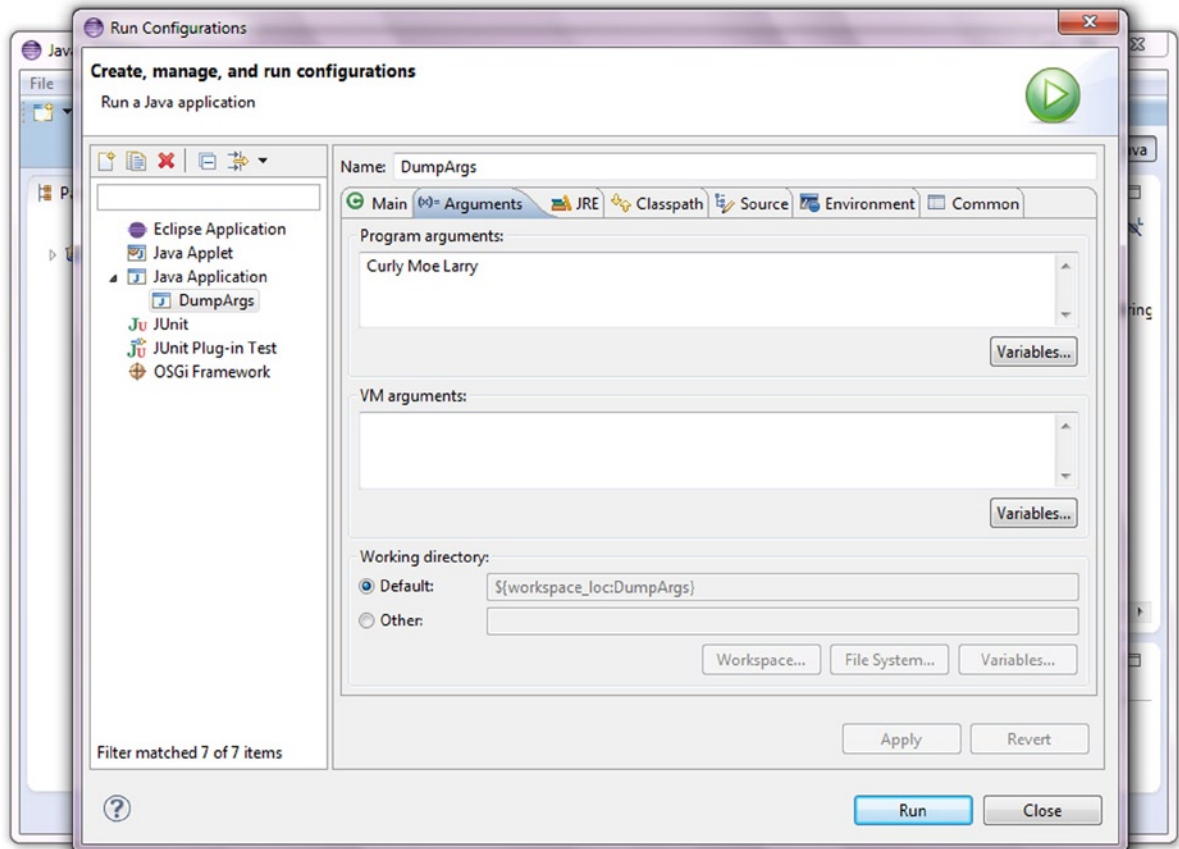

Figure 1-7. The Console tab at the bottom of the workbench presents the DumpArgs application's output

You must pass command-line arguments to DumpArgs to see additional output from this application. You can accomplish this task via these steps:

1. Select Run Configurations from the Run menu.
2. In the resulting Run Configurations dialog box, select the Arguments tab.
3. Enter **Curly Moe Larry** into the Program arguments text area, and click the Close button. See Figure 1-8.



**Figure 1-8.** Arguments are entered into the Program arguments text area

Once again, select Run from the Run menu to run the DumpArgs application. This time, the Console tab reveals Curly, Moe, and Larry on separate lines below "Passed arguments:".

This is all I have to say about the Eclipse IDE. For more information, study the tutorials via the Welcome tab, access IDE help via the Help menu, and explore the Eclipse documentation at [www.eclipse.org/documentation/](http://www.eclipse.org/documentation/).

## Java Meets Android

In the previous two editions of this book, I provided an introduction to Java language features and assorted APIs that are helpful when developing Android apps. Apart from a few small references to various Android items, I didn't delve into Android. This edition still explores Java language features and APIs that are useful in Android app development. However, it also introduces you to Android.

In this section, I first answer the "What is Android?" question. I next review Android's history and its various releases. After exploring Android's architecture, I present the Android version of HelloWorld.

**Note** This isn't all that I have to say about Android. In this book's code archive (see the introduction for the details on how to obtain this freebie) I've included a PDF-based Appendix C that digs deeper into Android. I couldn't include this information in the book proper because I only have room to present essential Java language features and APIs, which you must first learn.

## What Is Android?

*Android* is Google's software stack for mobile devices. This stack consists of apps (such as Browser and Contacts), a virtual machine in which apps run, *middleware* (software that sits on top of the operating system and provides various services to the virtual machine and its apps), and a Linux-based operating system.

Android offers the following features:

- An application framework enabling reuse and replacement of app components
- Bluetooth, EDGE, 3G, and Wi-Fi support (hardware dependent)
- Camera, GPS, compass, and accelerometer support (hardware dependent)
- Dalvik virtual machine optimized for mobile devices
- GSM Telephony support (hardware dependent)
- Integrated browser based on the open source WebKit engine
- Media support for common audio, video, and still image formats (MPEG4, H.264, MP3, AAC, AMR, JPG, PNG, GIF)
- Optimized graphics powered by a custom 2D graphics library; 3D graphics based on OpenGL ES 1.0, 1.1, 2.0, or 3.0 (hardware acceleration optional)
- SQLite for structured data storage (I introduce SQLite in Chapter 14.)

Although not part of the software stack, Android's rich development environment (including a device emulator and a plug-in for the Eclipse IDE) could also be considered an Android feature.

## History of Android

Contrary to what you might expect, Android didn't originate with Google. Instead, Android, Inc., a small Palo Alto, California-based startup company, initially developed Android. Google bought this company in the summer of 2005 and released a beta version of the Android SDK in November 2007.

On September 23, 2008, Google released Android 1.0, whose core features included a web browser, camera support, Google Search, Wi-Fi and Bluetooth support, and more. This release corresponds to API Level 1. (An *API level* is a 1-based integer that uniquely identifies the API revision offered by an Android version; it's a way of distinguishing one significant Android release from another.)

Table 1-1 outlines subsequent releases. (Starting with version 1.5, each major release comes under a code name that's based on a dessert item.)

**Table 1-1. Android Releases**

Version	API Level	Release Date and Changes
1.1	2	Google released SDK 1.1 on February 9, 2009. Changes included showing/hiding the speakerphone dialpad and saving attachments in messages.
1.5 (Cupcake)	3	Google released SDK 1.5 on April 30, 2009. Changes included recording and watching videos in MPEG-4 and 3GP formats, populating the <i>home screen</i> (a special app that's a starting point for using an Android device) with <i>widgets</i> (miniature app views), and animated screen transitions.
1.6 (Donut)	4	Google released SDK 1.6 on September 15, 2009. Changes included an expanded Gesture framework and the new GestureBuilder development tool, an integrated camera/camcorder/gallery interface, support for WVGA screen resolutions, and an updated search experience.
2.0 (Éclair)	5	Google released SDK 2.0 on October 26, 2009. Changes included live wallpapers, numerous new camera features (including flash support, digital zoom, scene mode, white balance, color effect, and macro focus), improved typing speed on the virtual keyboard, a smarter dictionary that learns from word usage and includes contact names as suggestions, improved Google Maps 3.1.2, and Bluetooth 2.1 support.
2.0.1 (Éclair)	6	Google released SDK update 2.0.1 on December 3, 2009. Version 2.0.1 focused on minor API changes, bug fixes, and framework behavioral changes.
2.1 (Éclair)	7	Google released SDK update 2.1 on January 12, 2010. Version 2.1 presented minor amendments to the API and bug fixes.

(continued)

**Table 1-1.** (continued)

Version	API Level	Release Date and Changes
2.2 - 2.2.3 (Froyo)	8	<p>Google released SDK 2.2 on May 20, 2009. Changes included the integration of Chrome's V8 JavaScript engine into the Browser app, support for Bluetooth-enabled car and desk docks, Adobe Flash support, additional app speed improvements through JIT compilation, and USB tethering and Wi-Fi hotspot functionality.</p> <p>Google subsequently released SDK update 2.2.1 on January 18, 2011 to offer bug fixes, security updates, and performance improvements. It then released SDK update 2.2.2 on January 22, 2011 to provide minor bug fixes, including SMS routing issues that affected the Nexus One. Finally, Google released SDK update 2.2.3 on November 21, 2011 to provide two security patches.</p>
2.3 - 2.3.2 (Gingerbread)	9	<p>Google released SDK 2.3 on December 6, 2010. Changes included a new concurrent garbage collector that improves an app's responsiveness, support for gyroscope and barometer sensing, support for WebM/VP8 video playback and AAC audio encoding, support for near field communication, and enhanced copy/paste functionality that lets users select a word by press-hold, copy, and paste.</p> <p>Google subsequently released SDK update 2.3.1 in December 2010 and SDK update 2.3.2 in January 2011. Both updates offered improvements and bug fixes for the Google Nexus S.</p>
2.3.3 - 2.3.7 (Gingerbread)	10	<p>Google released SDK update 2.3.3 on February 9, 2011, offering improvements and API fixes; SDK update 2.3.4 on April 28, 2011, adding support for voice or video chat via Google Talk and other features; SDK update 2.3.5 on July 25, 2011, offering camera software enhancements, shadow animations for list scrolling, improved battery efficiency, and more; SDK update 2.3.6 on September 2, 2011, fixing a voice search bug; and SDK update 2.3.7 on September 21, 2011, bringing support for Google Wallet to the Nexus S 4G.</p>
3.0 (Honeycomb)	11	<p>Google released SDK 3.0 on February 22, 2011. Unlike previous releases, version 3.0 focused exclusively on tablets, such as Motorola Xoom, the first tablet device featuring this version to be released. In addition to an improved and 3D user interface, version 3.0 improved multitasking, supported multicore processors, supported hardware acceleration, offered the ability to encrypt all user data, and more.</p>
3.1 (Honeycomb)	12	<p>Google released SDK 3.1 on May 10, 2011. Changes included user interface refinements, connectivity for USB accessories, support for joysticks and gamepads, and more.</p>

(continued)

**Table 1-1.** (continued)

Version	API Level	Release Date and Changes
3.2 (Honeycomb)	13	<p>Google released SDK 3.2 on July 15, 2011. Changes included improved hardware support, including optimizations for a wider range of tablets; a compatibility display mode for apps that haven't been optimized for tablet screen resolutions; and more.</p> <p>Google subsequently released SDK updates 3.2.1, 3.2.2, 3.2.3, 3.2.4, 3.2.5, and 3.2.6 from September 2011 through February 2012.</p>
4.0 - 4.0.2 (Ice Cream Sandwich)	14	<p>Google released SDK 4.0.1 on October 19, 2011. SDK 4.0 unified the 2.3.x smartphone and 3.x tablet SDKs. Features included 1080p video recording, a customizable launcher, and more.</p> <p>Google subsequently released SDK updates 4.0.1 and 4.0.2 in late 2011 to fix bugs.</p>
4.0.3 - 4.0.4 (Ice Cream Sandwich)	15	<p>Google released SDK 4.0.3 on September 16, 2011. Changes included improvements to graphics, databases, spell-checking, and Bluetooth functionality; new APIs for developers, including a social stream API in the Contacts provider; calendar provider enhancements; new camera apps enhancing video stabilization and QVGA resolution; and accessibility refinements such as improved content access for screen readers. Google then released SDK 4.0.4 on March 29, 2012. Changes included stability improvements, better camera performance, smoother screen rotation, and improved phone number recognition.</p>
4.1 (Jelly Bean)	16	<p>Google released SDK 4.1 on July 9, 2012. Changes included vsync timing, triple buffering, automatically resizable app widgets, improved voice search, multichannel audio, and expandable notifications.</p> <p>Google subsequently released SDK 4.1.1 on July 23, 2012 to fix a bug on the Nexus 7 regarding the inability to change screen orientation in any application. It then released SDK 4.1.2 on October 9, 2012 to provide lock/home screen rotation support for the Nexus 7, one-finger gestures to expand/collapse notifications, and bug fixes and performance enhancements.</p>

(continued)

**Table 1-1.** (continued)

Version	API Level	Release Date and Changes
4.2 (Jelly Bean)	17	<p>Google released SDK 4.2 on November 13, 2012. Changes included “Photo Sphere” panorama photos; lock screen improvements; a new clock app with built-in world clock, stop watch and timer; support for wireless display (known as Miracast), and more.</p> <p>Google subsequently released SDK 4.2.1 on November 27, 2012 to fix a bug in the People app where December wasn’t displayed on the date selector when adding an event to a contact and to add Bluetooth gamepads and joysticks as supported human interface devices. It then released SDK 4.2.2 on February 11, 2013 to fix Bluetooth audio streaming bugs; provide new download notifications, which now shows the percentage and estimated time remaining for active app downloads; provide new sounds for wireless charging and low battery; and more.</p>
4.3 (Jelly Bean)	18	<p>Google released SDK 4.3 on July 24, 2013. Changes included Bluetooth low-energy support; support for five more languages, improved digital rights management APIs, 4K resolution support, OpenGL ES 3.0 support (to allow for improved game graphics), and more.</p> <p>Google subsequently released SDK 4.3.1 on October 3, 2013 to fix bugs and provide small tweaks for the Nexus 7 LTE.</p>
4.4 - 4.4.2 (KitKat)	19	<p>Google released SDK 4.4 on October 31, 2013. Changes included streamlined memory usage and less heap usage, a loudness enhancer, screen recording, a transitions framework for animating scenes, a printing framework, full-screen immersive mode, audio monitoring, NFC Host Card Emulation, system-wide settings for closed captioning, and more.</p> <p>Google subsequently released SDK update 4.4.1 on December 5, 2013 with some camera improvements, bug fixes, and more. It then released SDK update 4.4.2 on December 9, 2013 with some security enhancements, bug fixes, and the removal of the application permissions control system introduced in SDK 4.3.</p>

Version 4.4.2 is the latest version at time of this writing. I focus on this version in Appendix C.

## Android Architecture

The Android software stack consists of apps at the top, a Linux kernel with various drivers at the bottom, and middleware (an application framework, libraries, and the Android runtime) in the center. Figure 1-9 shows this layered architecture.



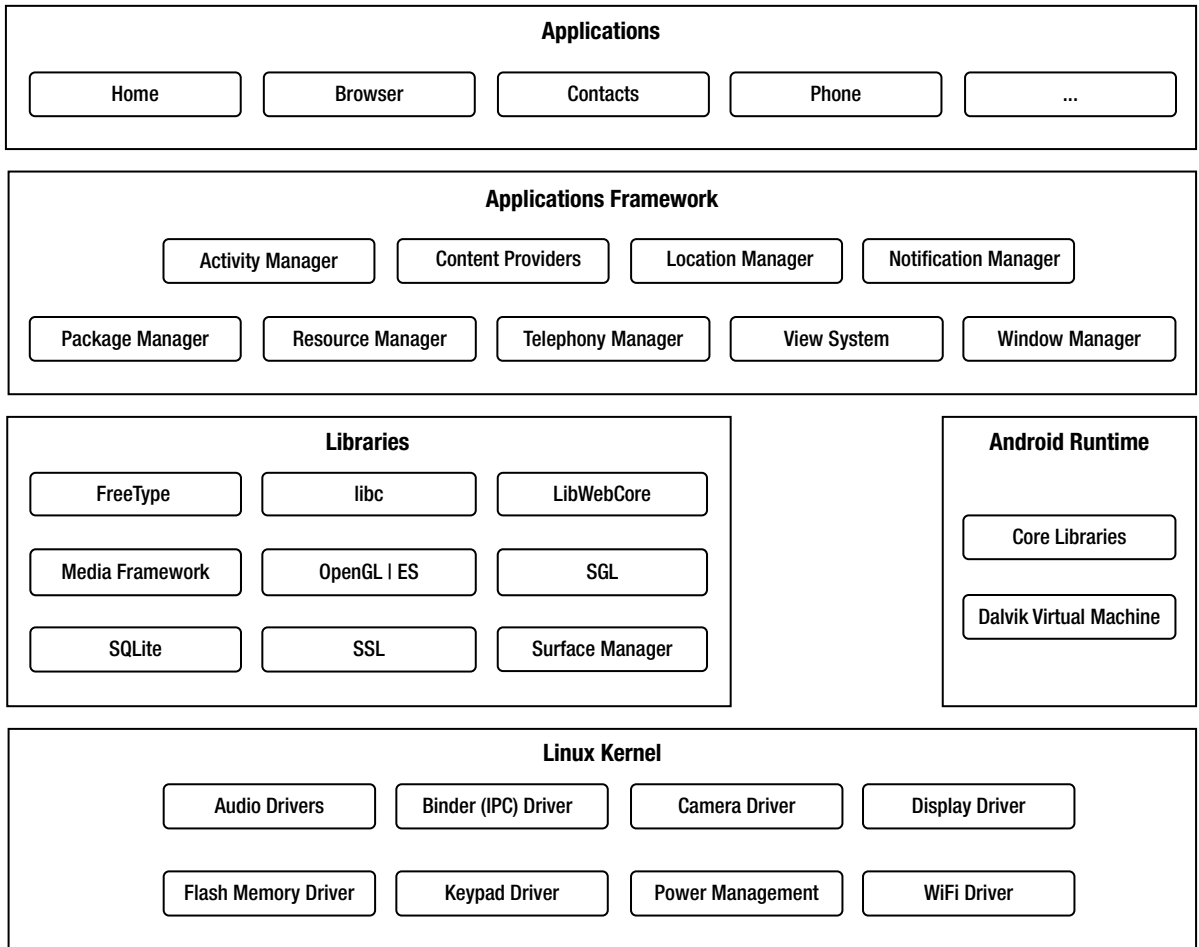

**Figure 1-9.** Android's layered architecture consists of several major parts

Users care very much about apps, and Android ships with a variety of useful core apps, which include Browser, Contacts, and Phone. All apps are written in the Java programming language. Apps form the top layer of Android's architecture.

Android doesn't officially recognize Java language features newer than Java 5, which is why I don't discuss them in this book. Regarding APIs, this platform supports many APIs from Java 6 and previous Java versions. Also, Android provides its own unique APIs.

**Note** It's possible to add support for Java language features that are more recent than Java 5 (see [www.informit.com/articles/article.aspx?p=1966024](http://www.informit.com/articles/article.aspx?p=1966024)).

Directly beneath the app layer is the *application framework*, a set of high-level building blocks for creating apps. The application framework is preinstalled on Android devices and consists of the following components:

- *Activity Manager*: This component provides an app's *life cycle* and maintains a shared activity stack for navigating within and among apps. Both topics are discussed in Appendix C.
- *Content Providers*: These components encapsulate data (such as the Browser app's bookmarks) that can be shared among apps.
- *Location Manager*: This component makes it possible for an Android device to be aware of its physical location.
- *Notification Manager*: This component lets an app notify the user of a significant event (such as a message's arrival) without interrupting what the user is currently doing.
- *Package Manager*: This component lets an app learn about other app packages that are currently installed on the device. (App packages are discussed in Appendix C.)
- *Resource Manager*: This component lets an app access its resources, a topic that's discussed in Appendix C.
- *Telephony Manager*: This component lets an app learn about a device's telephony services. It also handles making and receiving phone calls.
- *View System*: This component manages user interface elements and user interface-oriented event generation. (These topics are briefly discussed later in Appendix C.)
- *Window Manager*: This component organizes the screen's real estate into windows, allocates drawing surfaces, and performs other window-related jobs.

The components of the application framework rely on a set of C/C++ libraries to perform their functions. Developers interact with the following libraries by way of framework APIs:

- *FreeType*: This library supports bitmap and vector font rendering.
- *libc*: This library is a BSD-derived implementation of the standard C system library, tuned for embedded Linux-based devices.
- *LibWebCore*: This library offers a modern and fast web browser engine that powers the Android browser and an embeddable web view. It's based on WebKit (<http://en.wikipedia.org/wiki/WebKit>), and the Google Chrome and Apple Safari browsers also use it.
- *Media Framework*: These libraries, which are based on PacketVideo's OpenCORE, support the playback and recording of many popular audio and video formats, as well as working with static image files. Supported formats include MPEG4, H.264, MP3, AAC, AMR, JPEG, PNG, and GIF.

- *OpenGL | ES*: These 3D graphics libraries provide an OpenGL implementation based on OpenGL ES 1.0/1.1/2.0/3.0 APIs. They use hardware 3D acceleration (where available) or the included (and highly optimized) 3D software rasterizer.
- *SGL*: This library provides the underlying 2D graphics engine.
- *SQLite*: This library provides a powerful and lightweight relational database engine that's available to all apps and that's also used by Mozilla Firefox and Apple's iPhone for persistent storage.
- *SSL*: This library provides secure sockets layer-based security for network communication.
- *Surface Manager*: This library manages access to the display subsystem, and seamlessly composites 2D and 3D graphic layers from multiple apps.

Android provides a runtime environment that consists of core libraries (implementing a subset of the Apache Harmony Java version 5 implementation) and the *Dalvik virtual machine* (a non-JVM that's based on processor registers instead of being stack-based).

**Note** Google's Dan Bornstein created Dalvik and named this virtual machine after an Icelandic fishing village where some of his ancestors lived.

Each Android app defaults to running in its own Linux *process* (executing application), which hosts an instance of Dalvik. This virtual machine has been designed so that devices can run multiple virtual machines efficiently. This efficiency is largely due to Dalvik executing Dalvik Executable (DEX)-based files. DEX is a format that's optimized for a minimal memory footprint.

**Note** Android starts a process when any part of the app needs to execute, and it shuts down the process when it's no longer needed and system resources are required by other apps.

Perhaps you're wondering how it's possible to have a non-JVM run Java code. The answer is that Dalvik doesn't run Java code. Instead, Android transforms compiled Java classfiles (see Figure 1-2) into the DEX format via its *dx* tool, and it's this resulting code that gets executed by Dalvik.

Finally, the libraries and Android runtime rely on the Linux kernel (version 2.6.x, 3.0.x, or 3.8 [KitKat]) for underlying core services, such as threading, low-level memory management, a network stack, process management, and a driver model. Furthermore, the kernel acts as an abstraction layer between the hardware and the rest of the software stack.

## ANDROID SECURITY MODEL

Android's architecture includes a security model that prevents apps from performing operations that are considered harmful to other apps, Linux, or users. This security model is mostly based on process level enforcement via standard Linux features (such as user and group IDs), and places processes in a security *sandbox*.

By default, the sandbox prevents apps from reading or writing the user's private data (such as contacts or e-mails), reading or writing another app's files, performing network access, keeping the device awake, accessing the camera, and so on. Apps that need to access the network or perform other sensitive operations must first obtain permission to do so.

Android handles permission requests in various ways, typically by automatically allowing or disallowing the request based upon a certificate or by prompting the user to grant or revoke the permission. Permissions required by an app are declared in the app's manifest file (discussed in Appendix C) so that they are known to Android when the app is installed. These permissions won't subsequently change.

## Android Says Hello

Earlier in this chapter, I introduced you to HelloWorld, a Java application that outputs "Hello, World!" Because you might be curious about its Android equivalent, check out Listing 1-4.

*Listing 1-4. The Android Equivalent of HelloWorld*

```
public class HelloWorld extends android.app.Activity
{
    public void create(android.os.Bundle savedInstanceState)
    {
        super.onCreate(savedInstanceState);
        System.out.println("Hello, World!");
    }
}
```

Listing 1-4 isn't too different from Listing 1-1, but there are some significant changes. For one thing, HelloWorld *extends* another class named Activity (stored in a package named android.app—see Chapter 5 for a discussion of packages). By extending Activity, HelloWorld proclaims itself as an *activity*, which you can think of as a user interface screen. (I discuss extension in Chapter 4.)

By extending Activity, HelloWorld *inherits* that class's create() method, which Android calls when creating the activity. HelloWorld *overrides* this method with its own implementation so that it can output the "Hello, World!" message. However, create() first needs to execute Activity's version of this method (via super.onCreate()), so that the activity is properly initialized.

**Note** "Hello, World!" isn't displayed on an Android device's screen. Instead, it's written to a log file that can be examined by Android's adb tool. Appendix C discusses the log file, adb, and writing to the screen.

That's enough for now. You'll learn more about `create()` and other life cycle methods in Appendix C. However, you first need to learn more about the Java language.

**Note** `HelloWorld`, `DumpArgs`, and `EchoText` demonstrate `public static void main(String[] args)` as a Java application's entry point. This is where the application's execution begins. In contrast, as you've just seen, an Android app doesn't require this method for its entry point because the app's architecture is very different.

## EXERCISES

The following exercises are designed to test your understanding of Chapter 1's content.

1. What is Java?
2. What is a virtual machine?
3. What is the purpose of the Java compiler?
4. True or false: A classfile's instructions are commonly referred to as *bytecode*.
5. What does the JVM's interpreter do when it learns that a sequence of bytecode instructions is being executed repeatedly?
6. How does the Java platform promote portability?
7. How does the Java platform promote security?
8. True or false: Java SE is the Java platform for developing servlets.
9. What is the JRE?
10. What is the difference between the public and private JREs?
11. What is the JDK?
12. Which JDK tool is used to compile Java source code?
13. Which JDK tool is used to run Java applications?
14. What is Standard I/O?
15. How do you specify the `main()` method's header?
16. What is an IDE? Identify the IDE that Google supports for developing Android apps.
17. What is Android?
18. What is the API level associated with Android 4.4?
19. What is the DEX format?
20. What tool does Android use to transform compiled Java classfiles into the DEX format?

## Summary

Java is a language and a platform. The language is partly patterned after the C and C++ languages to shorten the learning curve for C/C++ developers. The platform consists of a virtual machine and associated execution environment.

The Java language shares several similarities with C/C++, such as presenting the same single-line and multi-line comments and offering various reserved words that are also found in C/C++. However, there are differences, such as providing `>>>` and other operators not found in C/C++.

The Java platform includes a huge library of prebuilt classfiles that perform common tasks, such as math operations (trigonometry, for example) and network communications. This library is commonly referred to as the standard class library.

A special Java program known as the Java compiler translates source code into object code consisting of instructions that are executed by the JVM and associated data. These instructions are known as bytecode.

Developers use different editions of the Java platform to create Java programs that run on desktop computers, web browsers, web servers, mobile information devices, and embedded devices. These editions are known as Java SE, Java EE, and Java ME.

The public JRE implements the Java SE platform and makes it possible to run Java programs. The JDK provides tools (including the Java compiler) for developing Java programs, and it also includes a private copy of the JRE.

Working with the JDK's tools at the command line isn't recommended for large projects, which are hard to manage without the help of an integrated development environment. Eclipse is a popular IDE that Google supports for developing Android apps.

Android is Google's software stack for mobile devices. This stack consists of apps, a virtual machine in which apps run, middleware that sits on top of the operating system and provides various services to the virtual machine and its apps, and a Linux-based operating system.

Android didn't originate with Google. Instead, Android, Inc., a small Palo Alto, California-based startup company, initially developed Android. Google bought this company in the summer of 2005, and it released Android 1.0 on September 23, 2008.

Android's architecture is based on an application layer, an application framework, libraries, an Android runtime (consisting of core libraries implementing a subset of the Apache Harmony Java version 5 implementation and the Dalvik virtual machine), and a Linux kernel.

Android doesn't officially recognize Java language features newer than Java 5, which is why I don't discuss them in this book. Regarding APIs, this platform supports many APIs from Java 6 and previous Java versions. Also, Android provides its own unique APIs.

Chapter 2 introduces you to the Java language by focusing on this language's fundamentals. You'll learn about comments, identifiers, types, variables, expressions, statements, and more.

# Learning Language Fundamentals

Aspiring Android app developers need to understand the Java language in which an app's source code is written. This chapter introduces you to this language by focusing on its fundamentals. Specifically, you'll learn about application structure, comments, identifiers (and reserved words), types, variables, expressions (and literals), and statements.

**Note** The American Standard Code for Information Interchange (ASCII) has traditionally been used to encode a program's source code. Because ASCII is limited to the English language, Unicode (<http://unicode.org/>) was developed as a replacement. *Unicode* is a computing industry standard for consistently encoding, representing, and handling text that's expressed in most of the world's writing systems. Because Java supports Unicode, non-English-oriented symbols can be integrated into or accessed from Java source code; you'll see examples in this chapter.

## Learning Application Structure

Chapter 1 introduced you to three small Java applications. Each application exhibited a similar structure that I employ throughout this book. Before developing Java applications, you need to understand this structure, which Listing 2-1 presents. Throughout this chapter, I present code fragments that you can paste into this structure to create working applications.

*Listing 2-1. Structuring a Java Application*

```
public class X
{
    public static void main(String[] args)
    {
        ...
    }
}
```

An application is based on a class declaration. (I discuss classes in Chapter 3.) The declaration begins with a header consisting of `public`, followed by `class`, followed by `X`, where `X` is a placeholder for the actual name, for example, `HelloWorld`. The header is followed by a pair of braces (`{` and `}`) that denote the class's body.

Between these braces is a special method declaration (I discuss methods in Chapter 3), which defines the application's entry point. It starts with a header that consists of `public`, followed by `static`, followed by `void`, followed by `main`, followed by `(String[] args)`. A pair of braces follows this header and denotes the method's body. The `...` represents code that you specify to execute.

You can pass a sequence of arguments to the application when executing it at the command line. These string-based arguments are stored in the `args` array (a *string* is a character sequence delimited by double quote `"` characters). I introduce arrays later in this chapter and further discuss them in Chapter 3. There's nothing special about `args`: I could choose another name for it, for example, `arguments`.

You must store this class declaration in a file whose name matches `X` and has a `.java` file extension. You would then compile the source code as follows:

```
javac X.java
```

`X` is a placeholder for the actual class name. Also, the `".java"` file extension is mandatory.

Assuming that compilation succeeds, which results in a classfile named `X.class` being created, you would subsequently run the application as follows:

```
java X
```

Replace `X` with the actual class name. Don't specify the `".class"` file extension.

If you need to pass command-line arguments to the application, specify them after the class name according to the following pattern:

```
java X arg1 arg2 arg3 ...
```

Here, `arg1`, `arg2`, and `arg3` are placeholders for three command-line arguments. The trailing `...` signifies additional arguments (if any).

Finally, if you need to specify a sequence of words as a single argument, place these words between double quotes to prevent `java` from treating them as separate arguments, like so:

```
java X "These words constitute a single argument."
```



**Note** The word `public` that precedes class isn't mandatory. When `public` isn't specified, you don't have to store the class declaration in a file whose name is the same as the class name. However, you still must specify the class name when running the application.

## Learning Comments

Source code needs to be documented so that you (and any others who have to maintain it) can understand it, now and later. Source code should be documented while being written and whenever it's modified. If these modifications impact existing documentation, the documentation must be updated so that it accurately explains the code.

Java provides the *comment* feature for embedding documentation in source code. When the source code is compiled, the Java compiler ignores all comments; no bytecodes are generated. Single-line, multiline, and Javadoc comments are supported.

## Single-Line Comments

A *single-line comment* occupies all or part of a single line of source code. This comment begins with the `//` character sequence and continues with explanatory text. The compiler ignores everything from `//` to the end of the line in which `//` appears.

The following example presents a single-line comment:

```
System.out.println(Math.sqrt(10 * 10 + 20 * 20)); // Output distance from (0, 0) to (10, 20).
```

This example calculates the distance between the (0, 0) origin and the point (10, 20) in the Cartesian *x/y* plane. It uses the formula *distance = square root(x<sup>2</sup>+y<sup>2</sup>)*, where *x* is 10 and *y* is 20, for this task. Java provides a `Math` class whose `sqrt()` method returns the square root of its single numeric argument. (I discuss `Math` in Chapter 7 and arguments in Chapter 3.)

**Note** Single-line comments are useful for inserting short but meaningful explanations of source code into this code. Don't use them to insert unhelpful documentation. For example, when declaring a variable, don't insert a meaningless comment such as `// This variable stores integer values.`

## Multiline Comments

A *multiline comment*, occupies one or more lines of source code. This comment begins with the `/*` character sequence, continues with explanatory text, and ends with the `*/` character sequence. Everything from `/*` through `*/` is ignored by the compiler.

The following example demonstrates a multiline comment:

```
/*
   A year is a leap year when it's divisible by 400, or divisible by 4 and
   not also divisible by 100.
*/
System.out.println(year % 400 == 0 || (year % 4 == 0 && year % 100 != 0));
```

This example assumes the existence of an integer variable (discussed later) named `year` that stores an arbitrary four-digit year. It evaluates a complex expression (discussed later) that determines whether the year is leap or not. The expression returns `true` (leap year) or `false` (not leap year), which is output by `System.out.println()`. The multiline comment explains what constitutes a leap year.

**Caution** You cannot place one multiline comment inside another. For example, `/**/` Nesting multiline comments is illegal! `*/*/` isn't a valid multiline comment.

## Javadoc Comments

Java supports a third kind of comment that simplifies the specification of external HTML-based documentation. You'll find this Javadoc comment feature helpful in the preparation of technical documentation for other developers who rely on your Java applications, libraries, and other Java-based software products.

A *Javadoc comment* occupies one or more lines of source code. This comment begins with the `/**` character sequence, continues with explanatory text, and ends with the `*/` character sequence. Everything from `/**` through `*/` is ignored by the compiler.

The following example demonstrates a Javadoc comment:

```
/**
 * Application entry point
 *
 * @param args array of command-line arguments passed to this method
 */
public static void main(String[] args)
{
    // TODO code application logic here
}
```

This example begins with a Javadoc comment that describes the `main()` method. Sandwiched between `/**` and `*/` is a description of the method and the `@param` *Javadoc tag* (an `@`-prefixed instruction to the javadoc tool).

The following list identifies several commonly used tags:

- `@author` identifies the source code's author.
- `@deprecated` identifies a source code entity (such as a method) that should no longer be used.

- @param identifies one of a method's parameters.
- @see provides a see-also reference.
- @since identifies the software release where the entity first originated.
- @return identifies the kind of value that the method returns.
- @throws documents an exception thrown from a method. (I discuss exceptions in Chapter 5.)

Listing 2-2 presents Chapter 1's DumpArgs application source code with Javadoc comments that describe the DumpArgs class and its main() method.

*Listing 2-2. Documenting an Application Class and Its main() Method*

```
/**
 * Dump all command-line arguments to standard output.
 *
 * @author Jeff Friesen
 */
public class DumpArgs
{
    /**
     * Application entry point.
     *
     * @param args array of command-line arguments.
     */
    public static void main(String[] args)
    {
        System.out.println("Passed arguments:");
        for (int i = 0; i < args.length; i++)
            System.out.println(args[i]);
    }
}
```

You can extract these documentation comments into a set of HTML files by using the JDK's javadoc tool as follows:

```
javadoc DumpArgs.java
```

javadoc responds by outputting the following messages:

```
Loading source file DumpArgs.java...
Constructing Javadoc information...
Standard Doclet version 1.7.0_06
Building tree for all the packages and classes...
Generating \DumpArgs.html...
Generating \package-frame.html...
Generating \package-summary.html...
Generating \package-tree.html...
Generating \constant-values.html...
```

Building index for all the packages and classes...  
 Generating \overview-tree.html...  
 Generating \index-all.html...  
 Generating \deprecated-list.html...  
 Building index for all classes...  
 Generating \allclasses-frame.html...  
 Generating \allclasses-noframe.html...  
 Generating \index.html...  
 Generating \help-doc.html...

It also generates several files, including the `index.html` documentation entry-point file. Point your browser to this file, and you should see a page similar to that shown in Figure 2-1.

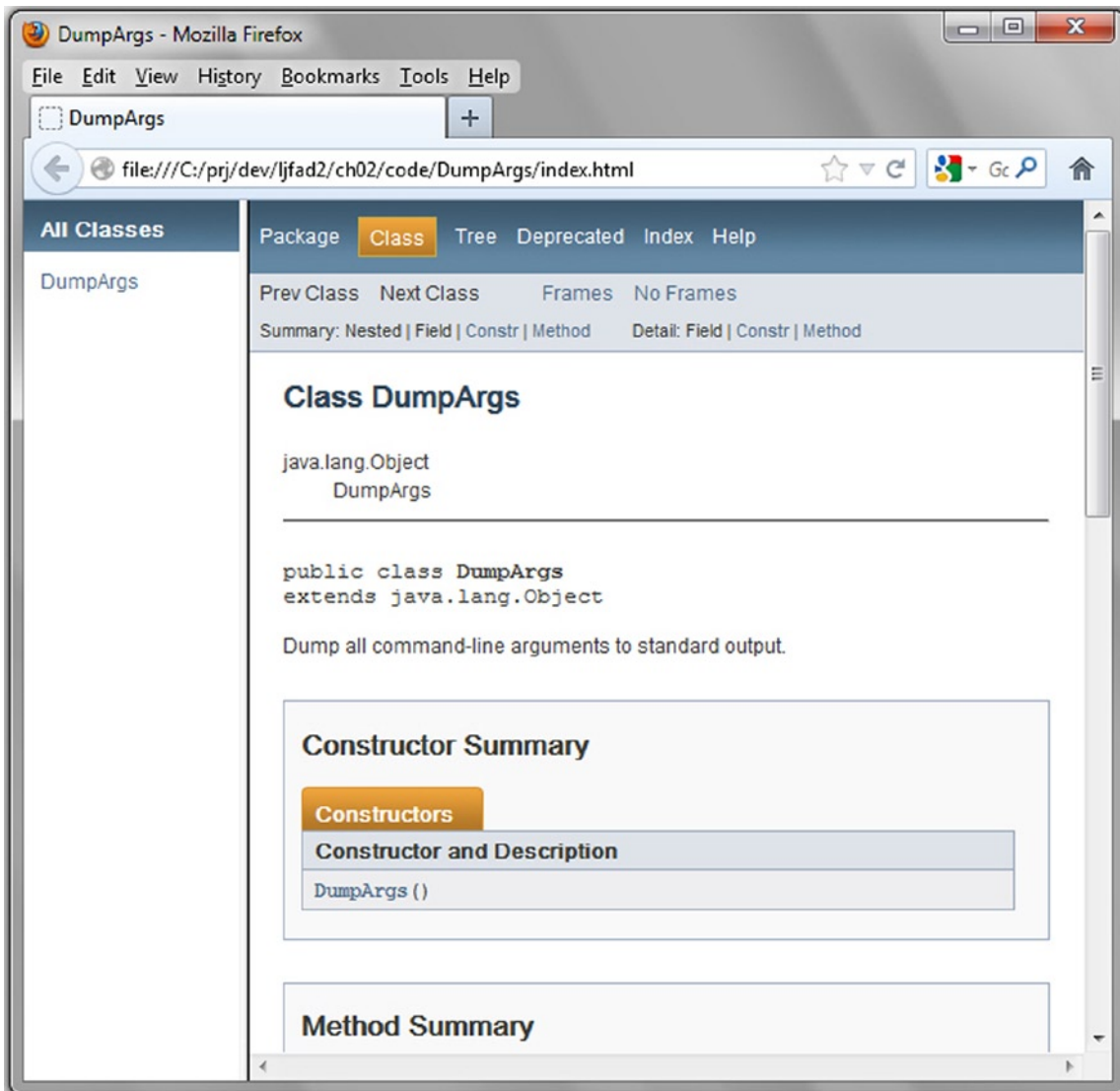

Figure 2-1. The entry-point page into `DumpArg`'s documentation describes this class

**Note** Appendix B provides another (and a more extensive) example involving Javadoc comments and the javadoc tool.

## Learning Identifiers

Source code entities such as classes and methods need to be named so that they can be referenced from elsewhere in the code. Java provides the identifiers feature for this purpose.

An *identifier* consists of letters (A-Z, a-z, or equivalent uppercase/lowercase letters in other human alphabets), digits (0-9 or equivalent digits in other human alphabets), connecting punctuation characters (such as the underscore), and currency symbols (such as the dollar sign, \$). This name must begin with a letter, a currency symbol, or a connecting punctuation character; and its length cannot exceed the line in which it appears.

Examples of valid identifiers include the following:

- $\pi$  (some editors might have problems with such symbols)
- `i`
- `counter`
- `j2`
- `first$name`
- `_for`

Examples of invalid identifiers include the following:

- `1name` (starts with a digit)
- `first#name` (# isn't a valid identifier symbol)

**Note** Java is a *case-sensitive language*, which means that identifiers differing only in case are considered separate identifiers. For example, `temperature` and `Temperature` are separate identifiers.

Almost any valid identifier can be chosen to name a class, method, or other source code entity. However, some identifiers are reserved for special purposes; they are known as *reserved words*. Java reserves the following identifiers:

<code>abstract</code>	<code>assert</code>	<code>boolean</code>	<code>break</code>	<code>byte</code>
<code>case</code>	<code>catch</code>	<code>char</code>	<code>class</code>	<code>const</code>
<code>continue</code>	<code>default</code>	<code>do</code>	<code>double</code>	<code>else</code>
<code>enum</code>	<code>extends</code>	<code>false</code>	<code>final</code>	<code>finally</code>
<code>float</code>	<code>for</code>	<code>goto</code>	<code>if</code>	<code>implements</code>
<code>import</code>	<code>instanceof</code>	<code>int</code>	<code>interface</code>	<code>long</code>
<code>native</code>	<code>new</code>	<code>null</code>	<code>package</code>	<code>private</code>
<code>protected</code>	<code>public</code>	<code>return</code>	<code>short</code>	<code>static</code>

strictfp	super	switch	synchronized	this
throw	throws	transient	true	try
void	volatile	while		

The compiler outputs an error message when you attempt to use any of these reserved words outside of their usage contexts. Also, `const` and `goto` are not used by the Java language.

Listing 2-1 revealed several identifiers: `public`, `class`, `X` (a placeholder for an identifier), `static`, `void`, `main`, `String`, and `args`. Identifiers `public`, `class`, `static`, and `void` are also reserved words.

**Note** Most of Java's reserved words are also known as *keywords*. The three exceptions are `false`, `null`, and `true`, which are examples of *literals* (values specified verbatim).

## Learning Types

Applications process data items, such as integers, floating-point values, characters, and strings. Data items are classified according to various characteristics. For example, integers are whole numbers without fractions. Also, a string is a sequence of characters that's treated as a unit and possesses a length that identifies the number of characters in the sequence.

Java uses the term *type* to describe classifications of data items. A *type* identifies a set of data items (and their representation in memory) and a set of operations that transform these data items into other data items of that set. For example, the integer type identifies numeric values with no fractional parts and integer-oriented math operations, such as adding two integers to yield another integer.

**Note** Java is a *strongly typed language*, which means that every expression, variable, and so on has a type known to the compiler. This capability helps the compiler detect type-related errors at compile time rather than having these errors manifest themselves at runtime. Expressions and variables are discussed later in this chapter.

Java recognizes primitive types, user-defined types, and array types. These types are defined in the following sections.

## Primitive Types

A *primitive type* is a type that's defined by the language and whose values are not objects. Java supports the Boolean, character, byte integer, short integer, integer, long integer, floating-point, and double precision floating-point primitive types. They are described in Table 2-1.

**Table 2-1. Primitive Types**

Primitive Type	Reserved Word	Size	Min Value	Max Value
Boolean	boolean	--	--	--
Character	char	16-bit	Unicode 0	Unicode 65,535
Byte integer	byte	8-bit	-128	+127
Short integer	short	16-bit	-32,768	+32,767
Integer	int	32-bit	-2,147,483,648	+2,147,483,647
Long integer	long	64-bit	-9,223,372,036,854,775,808	+9,223,372,036,854,775,807
Floating-point	float	32-bit	IEEE 754	IEEE 754
Double precision floating-point	double	64-bit	IEEE 754	IEEE 754

Table 2-1 describes each primitive type in terms of its reserved word, size, minimum value, and maximum value. A “--” entry indicates that the column in which it appears isn’t applicable to the primitive type described in that entry’s row.

The size column identifies the size of each primitive type in terms of the number of *bits* (binary digits; each digit is either 0 or 1) that a value of that type occupies in memory. Except for Boolean (whose size is implementation dependent; one Java implementation might store a Boolean value in a single bit, whereas another implementation might require an 8-bit *byte* for performance efficiency), each primitive type’s implementation has a specific size.

## BINARY VS. DECIMAL

Computers process numbers encoded via the *binary number system*, which is a base-2 number system in which there are only 2 digits: 0 and 1. In contrast, people process numbers according to the *decimal number system*, which is a base-10 number system in which there are 10 digits: 0 through 9.

It’s occasionally necessary to convert between binary integers and decimal integers. To convert from decimal to binary, you repeatedly follow these steps.

1. Set the integer quotient to the decimal integer.
2. If the quotient is 0, then stop.
3. Calculate quotient = quotient / 2. Output the remainder.
4. Go to Step 2.

For example, suppose you want to calculate the binary equivalent of decimal integer 19. According to the previous steps, you would need to perform these calculations:

$$19 / 2 = 9 \text{ Remainder } 1$$

$$9 / 2 = 4 \text{ Remainder } 1$$

$$4 / 2 = 2 \text{ Remainder } 0$$

$2 / 2 = 1$  Remainder 0

$1 / 2 = 0$  Remainder 1

The first remainder in this list refers to the least significant digit of the resulting binary number, which is 10011 in this example.

To convert from binary to decimal, process the integer's digits from right to left. Each of these digits represents a power of 2 where the rightmost digit's power is 0, the digit to its left has power 1, the digit to its left has power 2, and so on in an increasing sequence.

For example, 10011 corresponds to  $1 \times 2^4 + 0 \times 2^3 + 0 \times 2^2 + 1 \times 2^1 + 1 \times 2^0$ . Because any number to the power 0 equals 1, this expression equates to  $2^4 + 2^1 + 1$ , which equates to  $16 + 2 + 1$ , which equals 19.

The minimum value and maximum value columns identify the smallest and largest values that can be represented by each type. Except for Boolean (whose only values are true and false), each primitive type has a minimum value and a maximum value.

The minimum and maximum values of the character type refer to Unicode. **Unicode 0** is shorthand for “the first Unicode code point;” a *code point* is an integer that represents a symbol (such as A) or a control character (such as newline or tab) or that combines with other code points to form a symbol.

**Note** The character type's limits imply that this type is *unsigned* (all character values are positive). In contrast, each numeric type is *signed* (it supports positive and negative values).

The minimum and maximum values of the byte integer, short integer, integer, and long integer types reveal that there is one more negative value than positive value (0 is typically not regarded as a positive value). The reason for this imbalance has to do with how integers are represented.

Java represents an integer value as a combination of a *sign bit* (the leftmost bit; 0 for a positive value and 1 for a negative value) and *magnitude bits* (all remaining bits to the right of the sign bit). When the sign bit is 0, the magnitude is stored directly. However, when the sign bit is 1, the magnitude is stored using *twos-complement representation* in which all 1s are flipped to 0s, all 0s are flipped to 1s, and 1 is added to the number behind the minus sign.

Twos-complement is used so that negative integers can naturally coexist with positive integers. For example, adding the representation of -1 to +1 yields 0. Figure 2-2 illustrates byte integer 2's direct representation and byte integer -2's twos-complement representation.

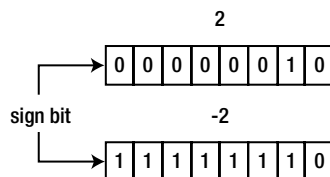

**Figure 2-2.** The binary representation of two byte-integer values begins with a sign bit



The minimum and maximum values of the floating-point and double precision floating-point types refer to *Institute of Electrical and Electronics Engineers (IEEE) 754*, which is a standard for representing floating-point values in memory. Check out Wikipedia’s “IEEE 754-2008” entry ([http://en.wikipedia.org/wiki/IEEE\\_754](http://en.wikipedia.org/wiki/IEEE_754)) to learn more about this standard.

**Note** Developers who argue that Java should support objects only aren’t happy about the inclusion of primitive types in the language. However, Java was designed to include primitive types to overcome the speed and memory limitations of early 1990s-era devices, to which Java was originally targeted.

## User-Defined Types

A *user-defined type* is a type that’s often used to model a real-world concept (such as a color or a bank account). The developer defines it using a class, an interface, an enum, or an annotation type; and its values are objects. (I discuss classes in Chapter 3, interfaces in Chapter 4, and enums and annotation types in Chapter 6.)

For example, you could create a `Color` class to model colors; its values could describe colors as red/green/blue components and its methods (see Chapter 3) could return these components.

**Note** You can think of Chapter 1’s `HelloWorld`, `DumpArgs`, and `EchoText` classes as examples of user-defined types. However, these classes aren’t used to create objects but describe applications instead.

Java’s `String` class defines the string user-defined type and is a member of the standard class library. Its values describe character sequences, and its methods perform string operations such as joining two strings. Unlike other user-defined types, `String` enjoys language support for initializing `String` variables and joining strings into a single string. You’ll see examples of this later in the chapter.

User-defined types are also known as *reference types* because a variable of that type stores a *reference* (a memory address or some other identifier) to a region of memory that stores an object of that type. In contrast, variables of primitive types store the values directly; they don’t store references to these values.

## Array Types

An *array type* is a special reference type that signifies an *array*, a region of memory that stores values in equal-size and contiguous slots, which are commonly referred to as *elements*. This type consists of the *element type* (a primitive type, user-defined type, or array type) and one or more pairs of square brackets that indicate the number of *dimensions* (extents). A single pair of brackets signifies a *one-dimensional array* (a vector), two pairs of brackets signify a *two-dimensional array* (a table), three pairs of brackets signify a one-dimensional array of two-dimensional arrays (a vector of tables), and so on. For example, `int[]` signifies a one-dimensional array (with `int` as the element type), and `double[][]` signifies a two-dimensional array (with `double` as the element type).

## Learning Variables

Applications manipulate values that are stored in memory, which is symbolically represented in source code through the use of the variables feature. A *variable* is a named memory location that stores some type of value. A variable that stores a reference is often referred to as a *reference variable*.

Variables must be declared before they're used. A declaration minimally consists of a type name, optionally followed by a sequence of square bracket pairs, followed by a name, optionally followed by a sequence of square bracket pairs, and terminated with a semicolon character (;). Consider the following examples:

```
int counter;           // Declare integer variable counter.
double temperature;   // Declare double precision floating-point variable temperature.
String firstName;     // Declare String variable firstName.
int[] ages;           // Declare one-dimensional integer array variable ages.
char gradeLetters[]; // Declare one-dimensional character array variable gradeLetters.
float[][] matrix;     // Declare two-dimensional floating-point array variable matrix.
double p;             // Declare double precision floating-point variable p.
```

No string is yet associated with `firstName`, and no arrays are yet associated with `ages`, `gradeLetters`, and `matrix`.

**Note** Square brackets can appear after the type name or after the variable name, but not in both places. For example, the compiler reports an error when it encounters `int[] x[]`; . It is common practice to place the square brackets after the type name (as in `int[] ages`;) instead of after the variable name (as in `char gradeLetters[]`;) , unless the array is being declared in a context such as `int x, y[], z`;

You can declare multiple variables on one line by separating each variable from its predecessor with a comma, as demonstrated by the following example:

```
int x, y[], z;
```

This example declares three variables named `x`, `y`, and `z`. Each variable shares the same type, which happens to be integer. Unlike `x` and `z`, which store single integer values, `y[]` signifies a one-dimensional array whose element type is integer; each element stores an integer value. No array is yet associated with `y`.

The square brackets must appear after the variable name when the array is declared on the same line as the other variables. If you place the square brackets before the variable name, as in `int x, []y, z`;, the compiler reports an error. If you place the square brackets after the type name, as in `int[] x, y, z`;, all three variables signify one-dimensional arrays of integers.

## Learning Expressions

The previously declared variables were not explicitly initialized to any values. As a result, they are either initialized to default values (such as 0 for `int` and 0.0 for `double`) or remain uninitialized, depending on the contexts in which they appear (declared within classes or declared within methods). In Chapter 3, I discuss variable contexts in terms of local variables, parameters, and fields.

Java provides the expressions feature for initializing variables and for other purposes. An *expression* is a combination of literals, variable names, method calls, and operators. At runtime, it evaluates to a value whose type is referred to as the expression's type. If the expression is being assigned to a variable, this type must agree with the variable's type; otherwise, the compiler reports an error.

Java recognizes simple expressions and compound expressions. These types are defined in the following sections.

### Simple Expressions

A *simple expression* is a *literal* (a value expressed verbatim), the name of a variable (containing a value), or a method call (returning a value). Java supports several kinds of literals: string, Boolean `true` and `false`, character, integer, floating-point, and `null`.

**Note** A method call that doesn't return a value—the called method is known as a *void method*—is a special kind of simple expression, for example, `System.out.println("Hello, World!");`. This standalone expression cannot be assigned to a variable. Attempting to do so (as in `int i = System.out.println("X");`) causes the compiler to report an error.

A *string literal* consists of a sequence of Unicode characters surrounded by a pair of double quotes, for example, "The quick brown fox jumps over the lazy dog." It might also contain *escape sequences*, which are special syntax for representing certain printable and nonprintable characters that cannot otherwise appear in the literal. For example, "The quick brown \"fox\" jumps over the lazy dog." uses the `\` escape sequence to surround fox with double quotes.

Table 2-2 describes all supported escape sequences.

Table 2-2. Escape Sequences

Escape Syntax	Description
\\	Backslash
\"	Double quote
\'	Single quote
\b	Backspace
\f	Form feed
\n	Newline (also referred to as line feed)
\r	Carriage return
\t	Horizontal tab

Finally, a string literal might contain *Unicode escape sequences*, which are special syntax for representing Unicode characters. A Unicode escape sequence begins with `\u` and continues with four hexadecimal digits (0-9, A-F, a-f) with no intervening space. For example, `\u0041` represents capital letter A, and `\u20ac` represents the European Union's euro currency symbol.

A *Boolean literal* consists of reserved word `true` or reserved word `false`.

A *character literal* consists of a single Unicode character surrounded by a pair of single quotes ('A' is an example). You can also represent, as a character literal, an escape sequence ('\'', for example) or a Unicode escape sequence (such as '\u0041').

An *integer literal* consists of a sequence of digits. If the literal is to represent a long integer value, it must be suffixed with an uppercase L or lowercase l (L is easier to read). If there is no suffix, the literal represents a 32-bit integer (an `int`).

Integer literals can be specified in the decimal, hexadecimal, and octal formats:

- The decimal format is the default format, for example, `127`.
- The hexadecimal format requires that the literal begin with `0x` or `0X` and continue with hexadecimal digits (0-9, A-F, a-f), for example, `0x7F`.
- The octal format requires that the literal be prefixed with `0` and continue with octal digits (0-7), for example, `0177`.

A *floating-point literal* consists of an integer part, a decimal point (represented by the period [.]), a fractional part, an exponent (starting with letter E or e), and a type suffix (letter D, d, F, or f). Most parts are optional, but enough information must be present to differentiate the floating-point literal from an integer literal. Examples include `0.1` (double precision floating-point), `89F` (floating-point), `600D` (double precision floating-point), and `13.08E+23` (double precision floating-point).

Finally, the `null` literal is assigned to a reference variable to indicate that the variable doesn't refer to an object.

Listing 2-3 presents a `SimpleExpressions` application that uses literals to initialize the previously presented variables.

*Listing 2-3. Using Literals to Initialize Variables*

```
public class SimpleExpressions
{
    public static void main(String[] args)
    {
        int counter = 10;
        double temperature = 98.6; // Assume Fahrenheit scale.
        String firstName = "Mark";
        int[] ages = { 52, 28, 93, 16 };
        char gradeLetters[] = { 'A', 'B', 'C', 'D', 'F' };
        float[][] matrix = { { 1.0F, 2.0F, 3.0F }, { 4.0F, 5.0F, 6.0F } };
        int x = 1, y[] = { 1, 2, 3 }, z = 3;
        double pi = 3.14159;
        System.out.println(counter);
        System.out.println(temperature);
        System.out.println(ages.length);
        System.out.println(gradeLetters.length);
        System.out.println(matrix.length);
        System.out.println(x);
        System.out.println(y.length);
        System.out.println(z);
        System.out.println(pi);
    }
}
```

The first example assigns 32-bit integer literal 10 to 32-bit integer variable `counter`. The second example assigns double precision floating-point literal 98.6 to double precision floating-point variable `temperature`. The third example assigns string literal "Mark" to `String` variable `firstName`.

The fourth through seventh examples use array initializers (such as { 52, 28, 93, 16 }) to initialize arrays that are assigned to the `ages`, `gradeLetters`, `matrix`, and `y` array variables. An *array initializer* consists of a brace-and-comma-delimited list of expressions, which (as the `matrix` example shows) may be array initializers. The `matrix` example results in a table that looks like the following:

```
1.0F 2.0F 3.0F
4.0F 5.0F 6.0F
```

Each array variable is associated with a `.length` property that returns the number of elements in the array. For example, because `ages` contains 4 elements, `ages.length` returns 4. Similarly, because `matrix` contains 2 rows, `matrix.length` returns 2. I'll have more to say about this property and also show you how to access array elements later in this chapter.

When you attempt to save this listing using an editor such as Windows Notepad, you'll probably be prompted to change the encoding from extended ASCII to Unicode (unless you've previously done so); otherwise, the  $\pi$  symbol will be lost. To compile the saved source code, you'll then need to include the `-encoding Unicode` option, as follows:

```
javac -encoding Unicode SimpleExpressions.java
```

You can then run this application via the following command line:

```
java SimpleExpressions
```

You should observe the following output:

```
10
98.6
4
5
2
1
3
3
3.14159
```

## ORGANIZING VARIABLES IN MEMORY

Perhaps you're curious about how variables are organized in memory. Figure 2-3 presents one possible high-level organization for the `counter`, `ages`, and `matrix` variables, along with the arrays assigned to `ages` and `matrix`.

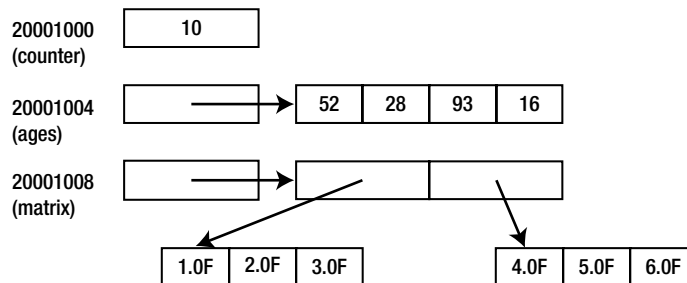

**Figure 2-3.** The `counter` variable stores a 4-byte integer value, whereas `ages` and `matrix` store 4-byte references to their respective arrays

Figure 2-3 reveals that each of `counter`, `ages`, and `matrix` is stored at a memory address (starting at a fictitious 20001000 value in this example) that's divisible by 4 (each variable stores a 4-byte value); that `counter`'s 4-byte value is stored at this address; and that each of the `ages` and `matrix` 4-byte memory locations stores the 32-bit address of its respective array (64-bit addresses would most likely be used on 64-bit virtual machines). Also, a one-dimensional array is stored as a list of values, whereas a two-dimensional array is stored as a one-dimensional row array of addresses, where each address identifies a one-dimensional column array of values for that row.

Although Figure 2-3 implies that array addresses are stored in `ages` and `matrix`, which equates references with addresses, a Java implementation might equate references with *handles* (integer values that identify slots in a list). This alternative is presented in Figure 2-4 for `ages` and its referenced array.

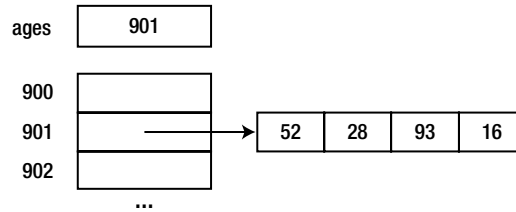

**Figure 2-4.** A handle is stored in *ages*, and the list entry identified by this handle stores the address of the associated array

Handles make it easy to move around regions of memory during garbage collection (discussed in Chapter 3). If multiple variables referenced the same array via the same address, each variable's address value would have to be updated when the array was moved. However, if multiple variables referenced the array via the same handle, only the handle's list entry would need to be updated. A downside to using handles is that accessing memory via these handles can be slower than directly accessing this memory via an address. Regardless of how references are implemented, this implementation detail is hidden from the Java developer to promote portability.

In addition to assigning literals to variables, you can also assign variables and the results of method calls to variables, like so:

```
int counter2 = counter;           // Assign previous counter variable value to counter2.
boolean isLeap = isLeapYear(2012); // Assign Boolean result of calling isLeapYear(2012) to isLeap.
```

These examples have assumed that only those expressions whose types are the same as the types of the variables that they are initializing can be assigned to those variables. However, under certain circumstances, it's possible to assign an expression having a different type. For example, Java permits you to assign certain integer literals to short integer variables, as in `short s = 20;`, and assign a short integer expression to an integer variable, as in `int i = s;`

Java permits the former assignment because 20 can be represented as a short integer (no information is lost). In contrast, Java would complain about `short s = 40000;` because integer literal 40000 cannot be represented as a short integer (32767 is the maximum positive integer that can be stored in a short integer variable). Java permits the latter assignment because no information is lost when Java converts from a type with a smaller set of values to a type with a wider set of values.

Java supports the following primitive-type conversions via widening conversion rules:

- Byte integer to short integer, integer, long integer, floating-point, or double precision floating-point
- Short integer to integer, long integer, floating-point, or double precision floating-point
- Character to integer, long integer, floating-point, or double precision floating-point
- Integer to long integer, floating-point, or double precision floating-point
- Long integer to floating-point or double precision floating-point
- Floating-point to double precision floating-point

Listing 2-4 presents a SimpleExpressions application that demonstrates these additional insights into simple expressions.

*Listing 2-4. Learning More About Simple Expressions*

```
public class SimpleExpressions
{
    public static void main(String[] args)
    {
        int counter = 30;
        int counter2 = counter;
        System.out.println(counter);

        short s = 20;
        System.out.println(s);
        int i = s;
        System.out.println(i);

        // short s2 = 40000; // possible loss of precision error

        int i2 = -1;
        double d = i2;
        System.out.println(d);
    }
}
```

This application demonstrates assigning one variable to another and assigning literal values to variables where the types don't match. For example, in the `double d = i2;` example, a widening conversion rule converts the 32-bit integer value stored in variable `i2` to a double precision floating-point value that's assigned to variable `d`.

Compile Listing 2-4 as follows:

```
javac SimpleExpressions.java
```

Unlike in the previous SimpleExpressions application, it isn't necessary to specifying `-encoding Unicode` because this listing contains no characters apart from those characters that can be represented by the extended ASCII character set (which is a subset of Unicode).

Run this application via the following command line:

```
java SimpleExpressions
```

You should observe the following output:

---

```
30
20
20
-1.0
```

---



**Note** When converting from a smaller integer to a larger integer, Java copies the smaller integer's sign bit into the extra bits of the larger integer.

In Chapter 4, I discuss the widening conversion rules for performing type conversions in the contexts of user-defined and array types.

## Compound Expressions

A *compound expression* is a sequence of simple expressions and operators, where an *operator* (a sequence of instructions symbolically represented in source code) transforms its *operand* expression value(s) into another value. For example, `-6` is a compound expression consisting of operator `-` and integer literal `6` as its operand. This expression transforms `6` into its negative equivalent. Similarly, `x + 5` is a compound expression consisting of variable name `x`, integer literal `5`, and operator `+` sandwiched between these operands. Variable `x`'s value is fetched and added to `5` when this expression is evaluated. The sum becomes the value of the expression.

**Note** When `x`'s type is byte integer or short integer, this variable's value is widened to an integer. However, when `x`'s type is long integer, floating-point, or double precision floating-point, `5` is widened to the appropriate type. The addition operation is performed after the widening conversion takes place.

Java supplies many operators, which are classified by the number of operands that they take. A *unary operator* takes only one operand (unary minus `[-]` is an example), a *binary operator* takes two operands (addition `[+]` is an example), and Java's single *ternary operator* (conditional `[?:]`) takes three operands.

Operators are also classified as prefix, postfix, and infix. A *prefix operator* is a unary operator that precedes its operand (as in `-6`), a *postfix operator* is a unary operator that trails its operand (as in `x++`), and an *infix operator* is a binary or ternary operator sandwiched between the binary operator's two or the ternary operator's three operands (as in `x + 5`).

Table 2-3 presents all supported operators in terms of their symbols, descriptions, and precedence levels; I discuss the concept of precedence at the end of this section. Various operator descriptions refer to "integer type," which is shorthand for specifying any of byte integer, short integer, integer, or long integer unless "integer type" is qualified as a 32-bit integer. Also, "numeric type" refers to any of these integer types along with floating-point and double precision floating-point.

Table 2-3. Operators

Operator	Symbol	Description	Precedence
Addition	+	Given <i>operand1</i> + <i>operand2</i> , where each operand must be of character or numeric type, add <i>operand2</i> to <i>operand1</i> and return the sum.	10
Array index	[ ]	Given <i>variable</i> [ <i>index</i> ], where <i>index</i> must be of integer type, read value from or store value into <i>variable</i> 's storage element at location <i>index</i> .	13
Assignment	=	Given <i>variable</i> = <i>operand</i> , which must be <i>assignment-compatible</i> (their types must agree), store <i>operand</i> in <i>variable</i> .	0
Bitwise AND	&	Given <i>operand1</i> & <i>operand2</i> , where each operand must be of character or integer type, bitwise AND their corresponding bits and return the result. A result bit is set to 1 when each operand's corresponding bit is 1. Otherwise, the result bit is set to 0.	6
Bitwise complement	~	Given ~ <i>operand</i> , where <i>operand</i> must be of character or integer type, flip <i>operand</i> 's bits (1s to 0s and 0s to 1s) and return the result.	12
Bitwise exclusive OR	^	Given <i>operand1</i> ^ <i>operand2</i> , where each operand must be of character or integer type, bitwise exclusive OR their corresponding bits and return the result. A result bit is set to 1 when one operand's corresponding bit is 1 and the other operand's corresponding bit is 0. Otherwise, the result bit is set to 0.	5
Bitwise inclusive OR		Given <i>operand1</i>   <i>operand2</i> , which must be of character or integer type, bitwise inclusive OR their corresponding bits and return the result. A result bit is set to 1 when either (or both) of the operands' corresponding bits is 1. Otherwise, the result bit is set to 0.	4
Cast	(type)	Given ( <i>type</i> ) <i>operand</i> , convert <i>operand</i> to an equivalent value that can be represented by <i>type</i> . For example, you could use this operator to convert a floating-point value to a 32-bit integer value.	12
Compound assignment	+=, -=, *=, /=, %=, &=,  =, ^=, <<=, >>=, >>>=	Given <i>variable</i> <i>operator</i> <i>operand</i> , where <i>operator</i> is one of the listed compound operator symbols and where <i>operand</i> is assignment-compatible with <i>variable</i> , perform the indicated operation using <i>variable</i> 's value as <i>operator</i> 's left operand value and store the resulting value in <i>variable</i> .	0
Conditional	?:	Given <i>operand1</i> ? <i>operand2</i> : <i>operand3</i> , where <i>operand1</i> must be of Boolean type, return <i>operand2</i> when <i>operand1</i> is true or <i>operand3</i> when <i>operand1</i> is false. The types of <i>operand2</i> and <i>operand3</i> must agree.	1

(continued)

Table 2-3. (continued)

Operator	Symbol	Description	Precedence
Conditional AND	&&	Given <i>operand1</i> && <i>operand2</i> , where each operand must be of Boolean type, return true when both operands are true. Otherwise, return false. When <i>operand1</i> is false, <i>operand2</i> isn't examined. This is known as <i>short-circuiting</i> .	3
Conditional OR		Given <i>operand1</i>    <i>operand2</i> , where each operand must be of Boolean type, return true when at least one operand is true. Otherwise, return false. When <i>operand1</i> is true, <i>operand2</i> isn't examined. This is known as <i>short-circuiting</i> .	2
Division	/	Given <i>operand1</i> / <i>operand2</i> , where each operand must be of character or numeric type, divide <i>operand1</i> by <i>operand2</i> and return the quotient.	11
Equality	==	Given <i>operand1</i> == <i>operand2</i> , where both operands must be comparable (you cannot compare an integer with a string literal, for example), compare both operands for equality. Return true when these operands are equal. Otherwise, return false.	7
Inequality	!=	Given <i>operand1</i> != <i>operand2</i> , where both operands must be comparable (you cannot compare an integer with a Boolean value, for example), compare both operands for inequality. Return true when these operands are not equal. Otherwise, return false.	7
Left shift	<<	Given <i>operand1</i> << <i>operand2</i> , where each operand must be of character or integer type, shift <i>operand1</i> 's binary representation left by the number of bits that <i>operand2</i> specifies. For each shift, a 0 is shifted into the rightmost bit and the leftmost bit is discarded. Only the 5 low-order bits of <i>operand2</i> are used when shifting a 32-bit integer (to prevent shifting more than the number of bits in a 32-bit integer). Only the 6 low-order bits of <i>operand2</i> are used when shifting a 64-bit integer (to prevent shifting more than the number of bits in a 64-bit integer). The shift preserves negative values. Furthermore, it's equivalent to (but faster than) multiplying by a multiple of 2.	9
Logical AND	&	Given <i>operand1</i> & <i>operand2</i> , where each operand must be of Boolean type, return true when both operands are true. Otherwise, return false. In contrast to conditional AND, logical AND doesn't perform short-circuiting.	6
Logical complement	!	Given ! <i>operand</i> , where <i>operand</i> must be of Boolean type, flip <i>operand</i> 's value (true to false or false to true) and return the result.	12

(continued)

Table 2-3. (continued)

Operator	Symbol	Description	Precedence
Logical exclusive OR	^	Given <i>operand1</i> ^ <i>operand2</i> , where each operand must be of Boolean type, return true when one operand is true and the other operand is false. Otherwise, return false.	5
Logical inclusive OR		Given <i>operand1</i>   <i>operand2</i> , where each operand must be of Boolean type, return true when at least one operand is true. Otherwise, return false. In contrast to conditional OR, logical inclusive OR doesn't perform short-circuiting.	4
Member access	.	Given <i>identifier1</i> . <i>identifier2</i> , access the <i>identifier2</i> member of <i>identifier1</i> . You'll learn about this operator in Chapter 3.	13
Method call	()	Given <i>identifier</i> ( <i>argument list</i> ), call the method identified by <i>identifier</i> and matching parameter list. You'll learn about method calling in Chapter 3.	13
Multiplication	*	Given <i>operand1</i> * <i>operand2</i> , where each operand must be of character or numeric type, multiply <i>operand1</i> by <i>operand2</i> and return the product.	11
Object creation	new	Given new <i>identifier</i> ( <i>argument list</i> ), allocate memory for object and call constructor (discussed in Chapter 3) specified as <i>identifier</i> ( <i>argument list</i> ). Given new <i>identifier</i> [ <i>integer size</i> ], allocate a one-dimensional array of values.	12
Postdecrement	--	Given <i>variable</i> --, where <i>variable</i> must be of character or numeric type, subtract 1 from <i>variable</i> 's value (storing the result in <i>variable</i> ) and return the original value.	13
Postincrement	++	Given <i>variable</i> ++, where <i>variable</i> must be of character or numeric type, add 1 to <i>variable</i> 's value (storing the result in <i>variable</i> ) and return the original value.	13
Predecrement	--	Given -- <i>variable</i> , where <i>variable</i> must be of character or numeric type, subtract 1 from its value, store the result in <i>variable</i> , and return the new decremented value.	12
Preincrement	++	Given ++ <i>variable</i> , where <i>variable</i> must be of character or numeric type, add 1 to its value, store the result in <i>variable</i> , and return the new incremented value.	12
Relational greater than	>	Given <i>operand1</i> > <i>operand2</i> , where each operand must be of character or numeric type, return true when <i>operand1</i> is greater than <i>operand2</i> . Otherwise, return false.	8
Relational greater than or equal to	>=	Given <i>operand1</i> >= <i>operand2</i> , where each operand must be of character or numeric type, return true when <i>operand1</i> is greater than or equal to <i>operand2</i> . Otherwise, return false.	8

(continued)

Table 2-3. (continued)

Operator	Symbol	Description	Precedence
Relational less than	<	Given <i>operand1</i> < <i>operand2</i> , where each operand must be of character or numeric type, return true when <i>operand1</i> is less than <i>operand2</i> . Otherwise, return false.	8
Relational less than or equal to	<=	Given <i>operand1</i> <= <i>operand2</i> , where each operand must be of character or numeric type, return true when <i>operand1</i> is less than or equal to <i>operand2</i> . Otherwise, return false.	8
Relational type checking	instanceof	Given <i>operand1</i> instanceof <i>operand2</i> , where <i>operand1</i> is an object and <i>operand2</i> is a class (or other user-defined type) return true when <i>operand1</i> is an instance of <i>operand2</i> . Otherwise, return false.	8
Remainder	%	Given <i>operand1</i> % <i>operand2</i> , where each operand must be of character or numeric type, divide <i>operand1</i> by <i>operand2</i> and return the remainder. Also known as the modulus operator.	11
Signed right shift	>>	Given <i>operand1</i> >> <i>operand2</i> , where each operand must be of character or integer type, shift <i>operand1</i> 's binary representation right by the number of bits that <i>operand2</i> specifies. For each shift, a copy of the sign bit (the leftmost bit) is shifted to the right and the rightmost bit is discarded. Only the 5 low-order bits of <i>operand2</i> are used when shifting a 32-bit integer (to prevent shifting more than the number of bits in a 32-bit integer). Only the 6 low-order bits of <i>operand2</i> are used when shifting a 64-bit integer (to prevent shifting more than the number of bits in a 64-bit integer). The shift preserves negative values. Furthermore, it's equivalent to (but faster than) dividing by a multiple of 2.	9
String concatenation	+	Given <i>operand1</i> + <i>operand2</i> , where at least one operand is of <code>String</code> type, append <i>operand2</i> 's string representation to <i>operand1</i> 's string representation and return the concatenated result.	10
Subtraction	-	Given <i>operand1</i> - <i>operand2</i> , where each operand must be of character or numeric type, subtract <i>operand2</i> from <i>operand1</i> and return the difference.	10
Unary minus	-	Given - <i>operand</i> , where <i>operand</i> must be of character or numeric type, return <i>operand</i> 's arithmetic negative.	12
Unary plus	+	Like its predecessor, but return <i>operand</i> . Rarely used.	12

(continued)

Table 2-3. (continued)

Operator	Symbol	Description	Precedence
Unsigned right shift	>>>	Given <i>operand1</i> >>> <i>operand2</i> , where each operand must be of character or integer type, shift <i>operand1</i> 's binary representation right by the number of bits that <i>operand2</i> specifies. For each shift, a zero is shifted into the leftmost bit and the rightmost bit is discarded. Only the 5 low-order bits of <i>operand2</i> are used when shifting a 32-bit integer (to prevent shifting more than the number of bits in a 32-bit integer). Only the 6 low-order bits of <i>operand2</i> are used when shifting a 64-bit integer (to prevent shifting more than the number of bits in a 64-bit integer). The shift doesn't preserve negative values. Furthermore, it's equivalent to (but faster than) dividing by a multiple of 2.	9

Table 2-3's operators can be classified as additive, array index, assignment, bitwise, cast, conditional, equality, logical, member access, method call, multiplicative, object creation, relational, shift, and unary minus/plus.

## Additive Operators

The additive operators consist of addition (+), subtraction (-), postdecrement (--), postincrement (++), predecrement (--), preincrement (++), and string concatenation (+). Addition returns the sum of its operands (such as `6 + 4` returns 10), subtraction returns the difference between its operands (such as `6 - 4` returns 2 and `4 - 6` returns -2), postdecrement subtracts 1 from its variable operand and returns the variable's prior value (such as `x--`), postincrement adds 1 to its variable operand and returns the variable's prior value (such as `x++`), predecrement subtracts 1 from its variable operand and returns the variable's new value (such as `--x`), preincrement adds 1 to its variable operand and returns the variable's new value (such as `++x`), and string concatenation merges its string operands and returns the merged string (such as `"A" + "B"` returns "AB").

The addition, subtraction, postdecrement, postincrement, predecrement, and preincrement operators can yield values that overflow or underflow the limits of the resulting value's type. For example, adding two large positive 32-bit integer values can produce a value that cannot be represented as a 32-bit integer value. The result is said to overflow. Java doesn't detect overflows and underflows.

Java provides a special widening conversion rule for use with string operands and the string concatenation operator. When either operand isn't a string, the operand is converted to a string prior to string concatenation. For example, when presented with `"A" + 5`, the compiler generates code that first converts 5 to "5" and then performs the string concatenation operation, resulting in "A5".

Listing 2-5 presents a `CompoundExpressions` application that lets you start experimenting with the additive operators.

*Listing 2-5. Experimenting with the Additive Operators*

```
public class CompoundExpressions
{
    public static void main(String[] args)
    {
        int age = 65;
        System.out.println(age + 32);
        System.out.println(++age);
        System.out.println(age--);
        System.out.println("A" + "B");
        System.out.println("A" + 5);
        short x = 32767;
        System.out.println(++x);
    }
}
```

Listing 2-5's `main()` method first declares a 32-bit integer `age` variable that's initialized to 32-bit integer value 65. It then outputs the result of an expression that adds `age`'s value to 32-bit integer value 32.

The preincrement and postdecrement operators are now demonstrated. First, preincrement adds 1 to `age` and the result is output. Then, `age`'s current value is output and this variable is then decremented via postdecrement. What `age` values do you think are output?

The next two expression examples demonstrate string concatenation. First, "B" is concatenated to "A" and the resulting AB is output. Then, 32-bit integer value 5 is converted to a one-character string consisting of character 5, which is then concatenated to "A". The resulting A5 is output.

At this point, overflow is demonstrated. First, a 16-bit short integer variable named `x` is declared and initialized to the largest positive short integer: 32767. The preincrement operator is then applied to `x` and the result (-32768) is output.

Compile Listing 2-5, as follows:

```
javac CompoundExpressions.java
```

Assuming successful compilation, execute the following command to run this application:

```
java CompoundExpressions
```

You should observe the following output:

---

```
97
66
66
AB
A5
-32768
```

---

## Array Index Operator

The array index operator (`[]`) accesses an array element by presenting the location of that element as an integer index. This operator is specified after an array variable's name, such as `ages[0]`.

Indexes are relative to 0, which implies that `ages[0]` accesses the first element, whereas `ages[6]` accesses the seventh element. The index must be greater than or equal to 0 and less than the length of the array; otherwise, the virtual machine throws `ArrayIndexOutOfBoundsException` (consult Chapter 5 to learn about exceptions).

An array's length is returned by appending `“.length”` to the array variable. For example, `ages.length` returns the length of (the number of elements in) the array that `ages` references. Similarly, `matrix.length` returns the number of row elements in the `matrix` two-dimensional array, whereas `matrix[0].length` returns the number of column elements assigned to the first row element of this array. (A two-dimensional array is essentially a one-dimensional row array of one-dimensional column arrays.)

Listing 2-6 presents a `CompoundExpressions` application that lets you start experimenting with the array index operator.

### *Listing 2-6. Experimenting with the Array Index Operator*

```
public class CompoundExpressions
{
    public static void main(String[] args)
    {
        int[] ages = { 52, 28, 93, 16 };
        char gradeLetters[] = { 'A', 'B', 'C', 'D', 'F' };
        float[][] matrix = { { 1.0F, 2.0F, 3.0F }, { 4.0F, 5.0F, 6.0F } };
        System.out.println(ages[0]);
        System.out.println(gradeLetters[2]);
        System.out.println(matrix[1][2]);
        System.out.println(ages[ '\u0002' ]);
        ages[1] = 19;
        System.out.println(ages[1]);
    }
}
```

Listing 2-6's `main()` method first declares and assigns arrays to variables `ages`, `gradeLetters`, and `matrix`. It then uses the array index operator to access the first element in the `ages` array (`ages[0]`), the third element in the `gradeLetters` array (`gradeLetters[2]`), and the third column element in the second row element of the `matrix` table array (`matrix[1][2]`).

Array indexes must be integer values. These values can be of byte integer, short integer, or integer type. However, they cannot be of long integer type because that could result in a loss of precision. The maximum number of elements that can be stored in an array is a bit less than the largest positive 32-bit integer; a long integer can be much larger than this value.

`main()` next demonstrates that you can also specify a character as an index value (`ages[ '\u0002' ]`). This is legal because Java supports a character-to-integer widening rule; it converts a character value to an integer value, which is then used as an index into the array (`ages[2]`). However, you should avoid using characters as array indexes because they're not intuitive and are potentially error prone. For example, what element is accessed by `ages[ 'A' ]`? The answer is the 66th element;



A's Unicode value is 65 and the first array index is 0. Given the previous four-element ages array, `ages[ 'A' ]` would result in `ArrayIndexOutOfBoundsException`.

Finally, `main()` demonstrates that you can also use the array index operator to assign a value to an array element. In this case, integer 19 is stored in the second array element, which is subsequently accessed and output.

Compile Listing 2-6 (`javac CompoundExpressions.java`) and run this application (`java CompoundExpressions`). You should observe the following output:

---

```
52
C
6.0
93
19
```

---

## Assignment Operators

The assignment operator (`=`) assigns an expression's result to a variable (as in `int x = 4;`). The types of the variable and expression must agree; otherwise, the compiler reports an error.

Java also supports several compound assignment operators that perform a specific operation and assign its result to a variable. For example, in `pennies += 50;`, the `+=` operator evaluates the numeric expression on its right (50) and adds the result to the contents of the variable on its left (`pennies`). The other compound assignment operators behave in a similar way.

## Bitwise Operators

The bitwise operators consist of bitwise AND (`&`), bitwise complement (`~`), bitwise exclusive OR (`^`), and bitwise inclusive OR (`|`). These operators are designed to work on the binary representations of their character or integral operands. Because this concept can be hard to understand if you haven't previously worked with these operators in another language, check out Listing 2-7.

*Listing 2-7. Experimenting with the Bitwise Operators*

```
public class CompoundExpressions
{
    public static void main(String[] args)
    {
        System.out.println(~181);
        System.out.println(26 & 183);
        System.out.println(26 ^ 183);
        System.out.println(26 | 183);
    }
}
```

Compile Listing 2-7 (`javac CompoundExpressions.java`) and run this application (`java CompoundExpressions`). You should observe the following output:

```
-182
18
173
191
```

To make sense of these values, it helps to examine their 32-bit binary representations:

- 181 corresponds to 000000000000000000000000010110101
- 26 corresponds to 0000000000000000000000000000011010
- 183 corresponds to 000000000000000000000000010110111

When you specify `~181`, you end up flipping all of the bits: `~000000000000000000000000010110101` results in `11111111111111111111111101001010`. According to twos-complement representation, an integer whose leading bit is 1 is regarded to be negative, which is why `~181` equates to `-182`.

The expression `26 & 183` can be represented in binary as follows:

```
000000000000000000000000011010
&
000000000000000000000000010110111
-----
000000000000000000000000010010
```

The resulting binary value equates to 18.

The expression `26 ^ 183` can be represented in binary as follows:

```
000000000000000000000000011010
^
000000000000000000000000010110111
-----
000000000000000000000000010110101
```

The resulting binary value equates to 173.

The expression `26 | 183` can be represented in binary as follows:

```
000000000000000000000000011010
|
000000000000000000000000010110111
-----
00000000000000000000000001111111
```

The resulting binary value equates to 191.

## Cast Operator

The cast operator—(*type*)—attempts to convert the type of its operand to *type*. This operator exists because the compiler will not allow you to convert a value from one type to another in which information will be lost without specifying your intention to do so (via the cast operator). For example, when presented with `short s = 1.65 + 3;`, the compiler reports an error because attempting to convert a 64-bit double precision floating-point value to a 16-bit signed short integer results in the loss of the fraction `.65`, so `s` would contain 4 instead of 4.65.

Recognizing that information loss might not always be a problem, Java permits you to state your intention explicitly by casting to the target type. For example, `short s = (short) 1.65 + 3;` tells the compiler that you want `1.65 + 3` to be converted to a short integer, and that you realize that the fraction will disappear.

The following example provides another demonstration of the need for a cast operator:

```
char c = 'A';  
byte b = c;
```

The compiler reports an error about loss of precision when it encounters `byte b = c;`. The reason is that `c` can represent any unsigned integer value from 0 through 65535, whereas `b` can only represent a signed integer value from -128 through +127. Even though `'A'` equates to +65, which can fit within `b`'s range, `c` could just have easily been initialized to `'\u0323'`, which wouldn't fit.

The solution to this problem is to introduce a (`byte`) cast operator as follows, which causes the compiler to generate code to cast `c`'s character type to byte integer:

```
byte b = (byte) c;
```

Java supports the following primitive-type conversions via cast operators:

- Byte integer to character
- Short integer to byte integer or character
- Character to byte integer or short integer
- Integer to byte integer, short integer, or character
- Long integer to byte integer, short integer, character, or integer
- Floating-point to byte integer, short integer, character, integer, or long integer
- Double precision floating-point to byte integer, short integer, character, integer, long integer, or floating-point

A cast operator isn't always required when converting from more to fewer bits and where no data loss occurs. For example, when it encounters `byte b = 100;`, the compiler generates code that assigns integer 100 to byte integer variable `b` because 100 can easily fit into the 8-bit storage location assigned to this variable.

Listing 2-8 presents a `CompoundExpressions` application that lets you start experimenting with the cast operator.

*Listing 2-8. Experimenting with the Cast Operator*

```
public class CompoundExpressions
{
    public static void main(String[] args)
    {
        short s = (short) 1.65 + 3;
        System.out.println(s);

        char c = 'A';
        byte b = (byte) c;
        System.out.println(b);

        b = 100;
        System.out.println(b);

        s = 'A';
        System.out.println(s);

        s = (short) '\uac00';
        System.out.println(s);
    }
}
```

Listing 2-8's `main()` method first uses the `(short)` cast operator to narrow the double precision floating-point expression `1.65 + 3` to a 16-bit short integer that's ultimately assigned to short integer variable `s`. After outputting `s`'s value (4), this method demonstrates the mandatory `(byte)` cast operator when converting from a 16-bit unsigned character type to an 8-bit signed byte integer type.

As previously mentioned, the `(byte)` cast operator isn't always required. For example, when assigning a 32-bit signed integer in the range of -128 through +127 to a byte integer variable, `(byte)` can be omitted because no information will be lost. Assigning 100 to `b` demonstrates this scenario.

In a similar way, various 16-bit unsigned character values (such as `'A'`) can be assigned to a 16-bit signed short integer variable without loss of information, and so the `(short)` cast operator can be avoided. However, other 16-bit unsigned character values don't fit into this range and must be cast to a short integer before assignment (`'\uac00'`, for example).

Compile Listing 2-8 (`javac CompoundExpressions.java`) and run this application (`java CompoundExpressions`). You should observe the following output:

---

```
4
65
100
65
-21504
```

---

## Conditional Operators

The conditional operators consist of conditional AND (&&), conditional OR (||), and conditional (? :). The first two operators always evaluate their left operand (a Boolean expression that evaluates to true or false) and conditionally evaluate their right operand (another Boolean expression). The third operator evaluates one of two operands based on a third Boolean operand.

Conditional AND always evaluates its left operand and evaluates its right operand only when its left operand evaluates to true. For example, `age > 64 && stillWorking` first evaluates `age > 64`. If this subexpression is true, `stillWorking` is evaluated, and its true or false value (`stillWorking` is a Boolean variable) serves as the value of the overall expression. If `age > 64` is false, `stillWorking` isn't evaluated.

Conditional OR always evaluates its left operand and evaluates its right operand only when its left operand evaluates to false. For example, `value < 20 || value > 40` first evaluates `value < 20`. If this subexpression is false, `value > 40` is evaluated, and its true or false value serves as the overall expression's value. If `value < 20` is true, `value > 40` isn't evaluated.

Conditional AND and conditional OR boost performance by preventing the unnecessary evaluation of subexpressions, which is known as *short-circuiting*. For example, if its left operand is false, there is no way that conditional AND's right operand can change the fact that the overall expression will evaluate to false.

If you aren't careful, short-circuiting can prevent *side effects* (the results of subexpressions that persist after the subexpressions have been evaluated) from executing. For example, `age > 64 && ++numEmployees > 5` increments `numEmployees` for only those employees whose ages are greater than 64. Incrementing `numEmployees` is an example of a side effect because the value in `numEmployees` persists after the subexpression `++numEmployees > 5` has evaluated.

The conditional operator is useful for making a decision by evaluating and returning one of two operands based upon the value of a third operand. The following example converts a Boolean value to its integer equivalent (1 for true and 0 for false):

```
boolean b = true;
int i = b ? 1 : 0; // 1 assigns to i
```

Listing 2-9 presents a `CompoundExpressions` application that lets you start experimenting with the conditional operators.

### Listing 2-9. Experimenting with the Conditional Operators

```
public class CompoundExpressions
{
    public static void main(String[] args)
    {
        int age = 65;
        boolean stillWorking = true;
        System.out.println(age > 64 && stillWorking);
        age--;
        System.out.println(age > 64 && stillWorking);
        int value = 30;
        System.out.println(value < 20 || value > 40);
    }
}
```

```

value = 10;
System.out.println(value < 20 || value > 40);
int numEmployees = 6;
age = 65;
System.out.println(age > 64 && ++numEmployees > 5);
System.out.println("numEmployees = " + numEmployees);
age = 63;
System.out.println(age > 64 && ++numEmployees > 5);
System.out.println("numEmployees = " + numEmployees);
boolean b = true;
int i = b ? 1 : 0; // 1 assigns to i
System.out.println("i = " + i);
b = false;
i = b ? 1 : 0; // 0 assigns to i
System.out.println("i = " + i);
    }
}

```

Compile Listing 2-9 (`javac CompoundExpressions.java`) and run this application (`java CompoundExpressions`). You should observe the following output:

---

```

true
false
false
true
true
numEmployees = 7
false
numEmployees = 7
i = 1
i = 0

```

---

## Equality Operators

The equality operators consist of equality (`==`) and inequality (`!=`). These operators compare their operands to determine whether they are equal or unequal. The former operator returns true when equal and the latter operator returns true when unequal. For example, each of `2 == 2` and `2 != 3` evaluates to true, whereas each of `2 == 4` and `4 != 4` evaluates to false.

You have to be careful when comparing floating-point expressions for equality. For example, what does `System.out.println(0.3 == 0.1 + 0.1 + 0.1)`; output? If you guessed that the output is true, you would be wrong. Instead, the output is false.

The reason for this nonintuitive output is that 0.1 cannot be represented exactly in memory. The error compounds when this value is added to itself. For example, if you executed `System.out.println(0.1 + 0.1 + 0.1)`; you would observe `0.30000000000000004`, which doesn't equal 0.3.

When it comes to object operands (I discuss objects in Chapter 3), these operators don't compare their contents. Instead, object references are compared. For example, `"abc" == "xyz"` doesn't compare a with x. Because string literals are really `String` objects (Chapter 7 discusses the `String` class), `==` compares the references to these objects.

## Logical Operators

The logical operators consist of logical AND (&), logical complement (!), logical exclusive OR (^), and logical inclusive OR (|). Although these operators are similar to their bitwise counterparts, whose operands must be integer/character, the operands passed to the logical operators must be Boolean. For example, !false returns true. Also, when confronted with age > 64 & stillWorking, logical AND evaluates both subexpressions; there's no short-circuiting. This same pattern holds for logical exclusive OR and logical inclusive OR.

Listing 2-10 presents a CompoundExpressions application that lets you start experimenting with the logical operators.

*Listing 2-10. Experimenting with the Logical Operators*

```
public class CompoundExpressions
{
    public static void main(String[] args)
    {
        System.out.println(!false);
        int age = 65;
        boolean stillWorking = true;
        System.out.println(age > 64 & stillWorking);
        System.out.println();

        boolean result = true & true;
        System.out.println("true & true: " + result);
        result = true & false;
        System.out.println("true & false: " + result);
        result = false & true;
        System.out.println("false & true: " + result);
        result = false & false;
        System.out.println("false & false: " + result);
        System.out.println();

        result = true | true;
        System.out.println("true | true: " + result);
        result = true | false;
        System.out.println("true | false: " + result);
        result = false | true;
        System.out.println("false | true: " + result);
        result = false | false;
        System.out.println("false | false: " + result);
        System.out.println();

        result = true ^ true;
        System.out.println("true ^ true: " + result);
        result = true ^ false;
        System.out.println("true ^ false: " + result);
        result = false ^ true;
        System.out.println("false ^ true: " + result);
        result = false ^ false;
        System.out.println("false ^ false: " + result);
        System.out.println();
    }
}
```

```
int numEmployees = 1;
age = 65;
System.out.println(age > 64 & ++numEmployees > 2);
System.out.println(numEmployees);
}
}
```

After outputting the results of the `!false` and `age > 64 & stillWorking` expressions, `main()` outputs three truth tables that show how logical AND, logical inclusive OR, and logical exclusive OR behave when their operands are true or false. It then demonstrates that short-circuiting is ignored by incrementing `numEmployees` when `age > 64` returns true.

Compile Listing 2-10 (`javac CompoundExpressions.java`) and run this application (`java CompoundExpressions`). You should observe the following output:

---

```
true
true

true & true: true
true & false: false
false & true: false
false & false: false

true | true: true
true | false: true
false | true: true
false | false: false

true ^ true: false
true ^ false: true
false ^ true: true
false ^ false: false

false
2
```

---

## Member Access Operator

The member access operator (`.`) is used to access a class's members or an object's members. For example, `String s = "Hello"; int len = s.length();` returns the length of the string assigned to variable `s`. It does so by calling the `length()` method member of the `String` class. In Chapter 3, I discuss member access in more detail.

Arrays are special objects that have a single `length` member. When you specify an array variable followed by the member access operator, followed by `length`, the resulting expression returns the number of elements in the array as a 32-bit integer. For example, `ages.length` returns the length of (the number of elements in) the array that `ages` references.



## Method Call Operator

The method call operator ( ) is used to signify that a method (discussed in Chapter 3) is being called. Also, it identifies the number, order, and types of arguments that are passed to the method to be picked up by the method's parameters. For example, in the `System.out.println("Hello");` method call, ( ) signifies that a method named `println` is being called with one argument: "Hello".

## Multiplicative Operators

The multiplicative operators consist of multiplication (\*), division (/), and remainder (%). Multiplication returns the product of its operands (such as `6 * 4` returns 24), division returns the quotient of dividing its left operand by its right operand (such as `6 / 4` returns 1), and remainder returns the remainder of dividing its left operand by its right operand (such as `6 % 4` returns 2).

The multiplication, division, and remainder operators can yield values that overflow or underflow the limits of the resulting value's type. For example, multiplying two large positive 32-bit integer values can produce a value that cannot be represented as a 32-bit integer value. The result is said to overflow. Java doesn't detect overflows and underflows.

Dividing a numeric value by 0 (via the division or remainder operator) also results in interesting behavior. Dividing an integer value by integer 0 causes the operator to throw an `ArithmeticException` object (Chapter 5 covers exceptions). Dividing a floating-point/double precision floating-point value by 0 causes the operator to return `+infinity` or `-infinity`, depending on whether the dividend is positive or negative. Finally, dividing floating-point 0 by 0 causes the operator to return `NaN` (Not a Number).

Listing 2-11 presents a `CompoundExpressions` application that lets you start experimenting with the multiplicative operators.

*Listing 2-11. Experimenting with the Multiplicative Operators*

```
public class CompoundExpressions
{
    public static void main(String[] args)
    {
        short age = 65;
        System.out.println(age * 1000);
        System.out.println(1.0 / 0.0);
        System.out.println(10 % 4);
        System.out.println(3 / 0);
    }
}
```

Compile Listing 2-11 (`javac CompoundExpressions.java`) and run this application (`java CompoundExpressions`). You should observe the following output:

---

```
65000
Infinity
2
Exception in thread "main" java.lang.ArithmeticException: / by zero
    at CompoundExpressions.main(CompoundExpressions.java:9)
```

---

## Object Creation Operator

The object creation operator (`new`) creates an object from a class, and it also creates an array from an initializer. These topics are discussed in Chapter 3.

## Relational Operators

The relational operators consist of greater than (`>`), greater than or equal to (`>=`), less than (`<`), less than or equal to (`<=`), and type checking (`instanceof`). The former four operators compare their operands and return `true` when the left operand is (respectively) greater than, greater than or equal to, less than, or less than or equal to the right operand. For example, each of `5.0 > 3`, `2 >= 2`, `16.1 < 303.3`, and `54.0 <= 54.0` evaluates to `true`.

The type-checking operator is used to determine if an object belongs to a specific type, returning `true` when this is the case. For example, `"abc" instanceof String` returns `true` because `"abc"` is a `String` object. I discuss this operator more fully in Chapter 4.

## Shift Operators

The shift operators consist of left shift (`<<`), signed right shift (`>>`), and unsigned right shift (`>>>`). Left shift shifts the binary representation of its left operand leftward by the number of positions specified by its right operand. Each shift is equivalent to multiplying by 2. For example, `2 << 3` shifts 2's binary representation left by three positions; the result is equivalent to multiplying 2 by 8.

Each of signed and unsigned right shift shifts the binary representation of its left operand rightward by the number of positions specified by its right operand. Each shift is equivalent to dividing by 2. For example, `16 >> 3` shifts 16's binary representation right by three positions; the result is equivalent to dividing 16 by 8.

The difference between signed and unsigned right shift is what happens to the sign bit during the shift. Signed right shift includes the sign bit in the shift, whereas unsigned right shift ignores the sign bit. As a result, signed right shift preserves negative numbers, but unsigned right shift doesn't. For example, `-4 >> 1` (the equivalent of `-4 / 2`) evaluates to `-2`, whereas `-4 >>> 1` evaluates to `2147483646`.

Listing 2-12 presents a `CompoundExpressions` application that lets you start experimenting with the shift operators.

**Listing 2-12. Experimenting with the Shift Operators**

```
public class CompoundExpressions
{
    public static void main(String[] args)
    {
        System.out.println(2 << 3);
        System.out.println(16 >> 3);
        System.out.println(-4 >> 1);
        System.out.println(-4 >>> 1);
    }
}
```

Compile Listing 2-12 (`javac CompoundExpressions.java`) and run this application (`java CompoundExpressions`). You should observe the following output:

```
16
2
-2
2147483646
```

**Tip** The shift operators are faster than multiplying or dividing by powers of 2.

## Unary Minus/Plus Operators

Unary minus (-) and unary plus (+) are the simplest of all operators. Unary minus returns the negative of its operand (such as -5 returns -5 and --5 returns 5), whereas unary plus returns its operand verbatim (such as +5 returns 5 and +-5 returns -5). Unary plus is not commonly used, but it is presented for completeness.

## Precedence and Associativity

When evaluating a compound expression, Java takes each operator's *precedence* (level of importance) into account to ensure that the expression evaluates as expected. For example, when presented with the expression `60 + 3 * 6`, you expect multiplication to be performed before addition (multiplication has higher precedence than addition) and the final result to be 78. You don't expect addition to occur first, yielding a result of 378.

**Note** Table 2-3's rightmost column presents a value that indicates an operator's precedence: the higher the number, the higher the precedence. For example, addition's precedence level is 10 and multiplication's precedence level is 11, which means that multiplication is performed before addition.

Precedence can be circumvented by introducing open and close parentheses, ( and ), into the expression, where the innermost pair of nested parentheses is evaluated first. For example, evaluating  $2 * ((60 + 3) * 6)$  results in  $(60 + 3)$  being evaluated first,  $(60 + 3) * 6$  being evaluated next, and the overall expression being evaluated last. Similarly, in the expression  $60 / (3 - 6)$ , subtraction is performed before division.

During evaluation, operators with the same precedence level (such as addition and subtraction, which both have level 10) are processed according to their *associativity* (a property that determines how operators having the same precedence are grouped when parentheses are missing).

For example, expression  $9 * 4 / 3$  is evaluated as if it was  $(9 * 4) / 3$  because  $*$  and  $/$  are left-to-right associative operators. In contrast, expression  $x = y = z = 100$  is evaluated as if it was  $x = (y = (z = 100))$ , where 100 is assigned to  $z$ ,  $z$ 's new value (100) is assigned to  $y$ , and  $y$ 's new value (100) is assigned to  $x$  because  $=$  is a right-to-left associative operator.

Most of Java's operators are left-to-right associative. Right-to-left associative operators include assignment, bitwise complement, cast, compound assignment, conditional, logical complement, object creation, predecrement, preincrement, unary minus, and unary plus.

Listing 2-13 presents a CompoundExpressions application that lets you start experimenting with precedence and associativity.

**Listing 2-13. Experimenting with Precedence and Associativity**

```
public class CompoundExpressions
{
    public static void main(String[] args)
    {
        System.out.println(60 + 3 * 6);
        System.out.println(2 * ((60 + 3) * 6));
        System.out.println(9 * 4 / 3);
        int x, y, z;
        x = y = z = 100;
        System.out.println(x);
        System.out.println(y);
        System.out.println(z);

        int i = 0x12345678;
        byte b = (byte) (i & 255);
        System.out.println(b);
        System.out.println("b == 0x78: " + (b == 0x78));
        b = (byte) ((i >> 8) & 255);
        System.out.println(b);
        System.out.println("b == 0x56: " + (b == 0x56));
        b = (byte) ((i >> 16) & 255);
        System.out.println(b);
        System.out.println("b == 0x34: " + (b == 0x34));
        b = (byte) ((i >> 24) & 255);
        System.out.println(b);
        System.out.println("b == 0x12: " + (b == 0x12));
    }
}
```

You'll often find yourself needing to use open and close parentheses to change an expression's evaluation order. For example, consider the second part of the `main()` method, which extracts each of the 4 bytes in the 32-bit value assigned to integer variable `i` and outputs this byte.

After processing the declaration and initialization of 32-bit integer variable `i` (`int i = 0x12345678;`), the compiler encounters byte `b = (byte) (i & 255);`. It generates bytecode that first evaluates expression `i & 255`, which returns a 32-bit result, passes this result to the `(byte)` cast operator to convert it to an 8-bit result, and assigns the 8-bit result to 8-bit byte integer variable `b`.

Suppose the parentheses were absent, resulting in byte `b = (byte) i & 255;`. The compiler would then report an error about loss of precision because it interprets this expression as follows.

1. Cast variable `i` to an 8-bit byte integer. The cast operator is a unary operator that takes only one operand. Also, cast has higher precedence (12) than bitwise AND (6) so cast is evaluated first.
2. Widen `i` to a 32-bit integer as the left operand of bitwise AND (&). Operand `255` is already a 32-bit integer.
3. Apply bitwise AND to these operands. The result is a 32-bit integer.
4. Attempt to assign the 32-bit integer result to 8-bit byte integer variable `b`.

The 32-bit integer result can vary from 0 through 255. However, the largest positive integer that `b` can store is 127. If the result ranges from 128 through 255, it will be converted to -1 through -128. This is a loss of precision and so the compiler reports an error.

Another example where `main()` uses open and close parentheses to change evaluation order is `System.out.println("b == 0x78: " + (b == 0x78));`. When the parentheses are missing, the compiler reports an "incomparable types: String and int" error. It does so because string concatenation has higher precedence (10) than equality (7). As a result, the compiler interprets the expression (without parentheses) as follows.

1. Convert `b`'s value to a string.
2. Concatenate this string to `"b == 0x78: "`.
3. Compare the resulting string with 32-bit integer `0x78` for equality, which is illegal.

Compile Listing 2-13 (`javac CompoundExpressions.java`) and run this application (`java CompoundExpressions`). You should observe the following output:

```
78
756
12
100
100
100
120
b == 0x78: true
86
b == 0x56: true
52
b == 0x34: true
18
b == 0x12: true
```

**Note** Unlike languages such as C++, Java doesn't let you overload operators. However, Java overloads the + (addition and string concatenation), ++ (preincrement and postincrement), and -- (predecrement and postdecrement) operator symbols.

## Learning Statements

*Statements* are the workhorses of a program. They assign values to variables, control a program's flow by making decisions and/or repeatedly executing other statements, and perform other tasks. A statement can be expressed as a simple statement or as a compound statement.

- A *simple statement* is a single standalone source code instruction for performing some task; it's terminated with a semicolon.
- A *compound statement* is a (possibly empty) sequence of simple and other compound statements sandwiched between open and close brace delimiters; a *delimiter* is a character that marks the beginning or end of some section. A method body (such as the `main()` method's body) is an example. Compound statements can appear wherever simple statements appear and are alternatively referred to as *blocks*.

In this section I introduce you to many of Java's statements. Additional statements are covered in later chapters. For example, in Chapter 3 I discuss the return statement.

## Assignment Statements

The *assignment statement* assigns a value to a variable. This statement begins with a variable name, continues with the assignment operator (=) or a compound assignment operator (such as +=), and concludes with an assignment-compatible expression and a semicolon. The following are three examples:

```
x = 10;  
ages[0] = 25;  
counter += 10;
```

The first example assigns integer 10 to variable `x`, which is presumably of type integer as well. The second example assigns integer 25 to the first element of the `ages` array. The third example adds 10 to the value stored in `counter` and stores the sum in `counter`.

**Note** Initializing a variable in the variable's declaration (such as `int counter = 1;`) can be thought of as a special form of the assignment statement.

## Decision Statements

The previously described conditional operator (`?:`) is useful for choosing between two expressions to evaluate and cannot be used to choose between two statements. For this purpose, Java supplies three decision statements: `if`, `if-else`, and `switch`.

### If Statement

The *if statement* evaluates a Boolean expression and executes another statement if this expression evaluates to true. It has the following syntax:

```
if (Boolean expression)  
    statement
```

This statement consists of reserved word `if`, followed by a *Boolean expression* in parentheses, followed by a *statement* to execute when *Boolean expression* evaluates to true.

The following example demonstrates the `if` statement:

```
if (numMonthlySales > 100)  
    wage += bonus;
```

If the number of monthly sales exceeds 100, `numMonthlySales > 100` evaluates to true and the `wage += bonus;` assignment statement executes. Otherwise, this assignment statement doesn't execute.

**Note** Many people prefer to wrap a single statement in brace characters in order to prevent the possibility of error. As a result, they would typically write the previous example as follows:

```
if (numMonthlySales > 100) {
    wage += bonus;
}
```

I don't do this for single statements because I view the extra braces as unnecessary clutter. However, you might feel differently. Use whatever approach makes you the most comfortable.

## If-Else Statement

The *if-else statement* evaluates a Boolean expression and executes one of two statements depending on whether this expression evaluates to true or false. It has the following syntax:

```
if (Boolean expression)
    statement1
else
    statement2
```

This statement consists of reserved word `if`, followed by a *Boolean expression* in parentheses, followed by a *statement1* to execute when *Boolean expression* evaluates to true, followed by a *statement2* to execute when *Boolean expression* evaluates to false.

The following example demonstrates the if-else statement:

```
if ((n & 1) == 1)
    System.out.println("odd");
else
    System.out.println("even");
```

This example assumes the existence of an `int` variable named `n` that's been initialized to an integer. It then proceeds to determine if the integer is odd (not divisible by 2) or even (divisible by 2).

The Boolean expression first evaluates `n & 1`, which bitwise ANDs `n`'s value with 1. It then compares the result to 1. If they're equal, a message stating that `n`'s value is odd outputs; otherwise, a message stating that `n`'s value is even outputs.

The parentheses are required because `==` has higher precedence than `&`. Without these parentheses, the expression's evaluation order would change to first evaluating `1 == 1` and then trying to bitwise AND the Boolean result with `n`'s integer value. This order results in a compiler error message because of a type mismatch: you cannot bitwise AND an integer with a Boolean value.

You could rewrite this if-else statement example to use the conditional operator, as follows:

```
System.out.println((n & 1) == 1 ? "odd" : "even");
```



However, you cannot do so with the following example:

```
if ((n & 1) == 1)
    odd();
else
    even();
```

This example assumes the existence of `odd()` and `even()` methods that don't return anything. Because the conditional operator requires that each of its second and third operands evaluates to a value, the compiler reports an error when attempting to compile `(n & 1) == 1 ? odd() : even()`.

You can chain multiple if-else statements together, resulting in the following syntax:

```
if (Boolean expression1)
    statement1

else
if (Boolean expression2)
    statement2

else
    ...
else
    statementN
```

If *Boolean expression1* evaluates to true, *statement1* executes. Otherwise, if *Boolean expression2* evaluates to true, *statement2* executes. This pattern continues until one of these expressions evaluates to true and its corresponding statement executes, or the final `else` is reached and *statementN* (the default statement) executes.

Listing 2-14 presents a `GradeLetters` application that demonstrates chaining together multiple if-else statements.

**Listing 2-14. Experimenting with If-Else Chaining**

```
public class GradeLetters
{
    public static void main(String[] args)
    {
        int testMark = 69;
        char gradeLetter;

        if (testMark >= 90)
        {
            gradeLetter = 'A';
            System.out.println("You aced the test.");
        }
        else
        if (testMark >= 80)
        {
            gradeLetter = 'B';
            System.out.println("You did very well on this test.");
        }
    }
}
```

```
else
if (testMark >= 70)
{
    gradeLetter = 'C';
    System.out.println("You'll need to study more for future tests.");
}
else
if (testMark >= 60)
{
    gradeLetter = 'D';
    System.out.println("Your test result suggests that you need a tutor.");
}
else
{
    gradeLetter = 'F';
    System.out.println("Your fail and need to attend summer school.");
}

System.out.println("Your grade is " + gradeLetter + ".");
}
}
```

Compile Listing 2-14 as follows:

```
javac GradeLetters.java
```

Execute the resulting application as follows:

```
java GradeLetters
```

You should observe the following output:

---

```
Your test result suggests that you need a tutor.
Your grade is D.
```

---

### DANGLING-ELSE PROBLEM

When if and if-else are used together and the source code isn't properly indented, it can be difficult to determine which if associates with the else. See the following, for example:

```
if (car.door.isOpen())
    if (car.key.isPresent())
        car.start();
else car.door.open();
```

Did the developer intend for the `else` to match the inner `if`, but improperly formatted the code to make it appear otherwise? This reformatted possibility appears below:

```
if (car.door.isOpen())
  if (car.key.isPresent())
    car.start();
  else
    car.door.open();
```

If `car.door.isOpen()` and `car.key.isPresent()` each return `true`, `car.start()` executes. If `car.door.isOpen()` returns `true` and `car.key.isPresent()` returns `false`, `car.door.open()`; executes. Attempting to open an open door makes no sense.

The developer must have wanted the `else` to match the outer `if` but forgot that `else` matches the nearest `if`. This problem can be fixed by surrounding the inner `if` with braces, as follows:

```
if (car.door.isOpen())
{
  if (car.key.isPresent())
    car.start();
}
else
  car.door.open();
```

When `car.door.isOpen()` returns `true`, the compound statement executes. When this method returns `false`, `car.door.open()`; executes, which makes sense.

Forgetting that `else` matches the nearest `if` and using poor indentation to obscure this fact is known as the *dangling-else problem*.

---

## Switch Statement

The *switch statement* lets you choose from among several execution paths in a more efficient manner than with equivalent chained `if-else` statements. It has the following syntax:

```
switch (selector expression)
{
  case value1: statement1 [break;]
  case value2: statement2 [break;]
  ...
  case valueN: statementN [break;]
  [default: statement]
}
```

This statement consists of reserved word `switch`, followed by a *selector expression* in parentheses, followed by a body of cases. The *selector expression* is any expression that evaluates to an integer or character value. For example, it might evaluate to a 32-bit integer or to a 16-bit character.

Each case begins with reserved word `case`, continues with a literal value and a colon character (`:`), continues with a statement to execute; and optionally concludes with a `break` statement, which causes execution to continue after the `switch` statement.

After evaluating the *selector expression*, `switch` compares this value with each case's value until it finds a match. When there is a match, the case's statement is executed. For example, when the *selector expression's* value matches *value1*, *statement1* executes.

The optional `break` statement (anything placed in square brackets is optional), which consists of reserved word `break` followed by a semicolon, prevents the flow of execution from continuing with the next case's statement. Instead, execution continues with the first statement following `switch`.

**Note** You'll usually place a `break` statement after a case's statement. Forgetting to include `break` can lead to a hard-to-find bug. However, there are situations where you want to group several cases together and have them execute common code. In this situation, you would omit the `break` statement from the participating cases.

If none of the cases' values match the *selector expression's* value, and if a default case (signified by the default reserved word followed by a colon) is present, the default case's statement is executed.

The following example demonstrates this statement:

```
switch (direction)
{
    case 0: System.out.println("You are travelling north."); break;
    case 1: System.out.println("You are travelling east."); break;
    case 2: System.out.println("You are travelling south."); break;
    case 3: System.out.println("You are travelling west."); break;
    default: System.out.println("You are lost.");
}
```

This example assumes that `direction` stores an integer value. When this value is in the range 0-3, an appropriate direction message is output; otherwise, a message about being lost is output.

**Note** This example hardcodes values 0, 1, 2, and 3, which isn't a good idea in practice. Instead, constants should be used. Chapter 3 introduces you to constants.

## Loop Statements

It's often necessary to repeatedly execute a statement; this repeated execution is called a *loop*. Java provides three kinds of loop statements: `for`, `while`, and `do-while`. In this section, I first discuss these statements. I then examine the topic of looping over the empty statement. Finally, I discuss the `break`, labeled `break`, `continue`, and labeled `continue` statements for prematurely ending all or part of a loop.

## For Statement

The *for statement* lets you loop over a statement a specific number of times or even indefinitely. It has the following syntax:

```
for ([initialize]; [test]; [update])  
    statement
```

This statement consists of reserved word *for*, followed by a header in parentheses, followed by a *statement* to execute. The header consists of an optional *initialize* section, followed by an optional *test* section, followed by an optional *update* section. A nonoptional semicolon separates each of the first two sections from the next section.

The *initialize* section consists of a comma-separated list of variable declarations or variable assignments. Some or all of these variables are typically used to control the loop's duration and are known as *loop-control variables*.

The *test* section consists of a Boolean expression that determines how long the loop executes. Execution continues as long as this expression evaluates to true.

Finally, the *update* section consists of a comma-separated list of expressions that typically modify the loop-control variables.

The *for statement* is perfect for *iterating* (looping) over an array. Each *iteration* (loop execution) accesses one of the array's elements via an *array[index]* expression, where *array* is the array whose element is being accessed and *index* is the zero-based location of the element being accessed.

The following example uses *for* to iterate over the array of command-line arguments passed to *main()*:

```
public static void main(String[] args)  
{  
    for (int i = 0; i < args.length; i++)  
        System.out.println(args[i]);  
}
```

The initialization section declares variable *i* for controlling the loop, the test section compares *i*'s current value to the length of the *args* array to ensure that this value is less than the array's length, and the update section increments *i* by 1. The *for*-based loop continues until *i*'s value equals the array's length.

Each array element is accessed via the *args[i]* expression, which returns this array's *i*th element's value (which happens to be a *String* object in this example). The first value is stored in *args[0]*.

**Note** Although I've named the array containing command-line arguments *args*, this name isn't mandatory. I could as easily have named it *arguments* (or even *some\_other\_name*).

Listing 2-15 presents a DumpMatrix application that uses a for-based loop to output the contents of a two-dimensional matrix array.

*Listing 2-15. Iterating over a Two-Dimensional Array's Rows and Columns*

```
public class DumpMatrix
{
    public static void main(String[] args)
    {
        float[][] matrix = { { 1.0F, 2.0F, 3.0F }, { 4.0F, 5.0F, 6.0F } };
        for (int row = 0; row < matrix.length; row++)
        {
            for (int col = 0; col < matrix[row].length; col++)
                System.out.print(matrix[row][col] + " ");
            System.out.print("\n");
        }
    }
}
```

Expression `matrix.length` returns the number of rows in this tabular array. For each row, expression `matrix[row].length` returns the number of columns for that row. This latter expression suggests that each row can have a different number of columns, although each row has the same number of columns in the example.

`System.out.print()` is closely related to `System.out.println()`. Unlike the latter method, `System.out.print()` outputs its argument without a trailing newline.

Compile Listing 2-15 as follows:

```
javac DumpMatrix.java
```

Execute the resulting application as follows:

```
java DumpMatrix
```

You should observe the following output:

---

```
1.0 2.0 3.0
4.0 5.0 6.0
```

---

## While Statement

The *while statement* repeatedly executes another statement while its Boolean expression evaluates to true. It has the following syntax:

```
while (Boolean expression)
    statement
```

This statement consists of reserved word `while`, followed by a parenthesized *Boolean expression*, followed by a *statement* to execute repeatedly. The `while` statement first evaluates the *Boolean*

*expression*. If it's true, while executes the other *statement*. Once again, the *Boolean expression* is evaluated. If it's still true, while re-executes the *statement*. This cyclic pattern continues.

Prompting the user to enter a specific character is one situation where while is useful. For example, suppose that you want to prompt the user to enter a specific uppercase letter or its lowercase equivalent. The following example provides a demonstration:

```
int ch = 0;
while (ch != 'C' && ch != 'c')
{
    System.out.println("Press C or c to continue.");
    ch = System.in.read();
}
```

This example first initializes variable `ch`. This variable must be initialized; otherwise, the compiler will report an uninitialized variable when it tries to read `ch`'s value in the while statement's Boolean expression.

This expression uses the conditional AND operator (`&&`) to test `ch`'s value. This operator first evaluates its left operand, which happens to be expression `ch != 'C'`. (The `!=` operator converts `'C'` from 16-bit unsigned `char` type to 32-bit signed `int` type before the comparison.)

If `ch` doesn't contain `C` (it doesn't at this point; `0` was just assigned to `ch`), this expression evaluates to true.

The `&&` operator next evaluates its right operand, which happens to be expression `ch != 'c'`. Because this expression also evaluates to true, conditional AND returns true and while executes the compound statement.

The compound statement first outputs, via the `System.out.println()` method call, a message that prompts the user to press the `C` key with or without the Shift key. It next reads the entered keystroke via `System.in.read()`, saving its integer value in `ch`.

From left to right, `System` identifies a standard class of system utilities, `in` identifies an object located in `System` that provides methods for inputting one or more bytes from the standard input device, and `read()` returns the next byte (or `-1` when there are no more bytes).

After this assignment, the compound statement ends and while re-evaluates its Boolean expression.

Suppose `ch` contains `C`'s integer value. Conditional AND evaluates `ch != 'C'`, which evaluates to false. Detecting that the expression is already false, conditional AND short-circuits its evaluation by not evaluating its right operand and returns false. The while statement subsequently detects this value and terminates.

Suppose `ch` contains `c`'s integer value. Conditional AND evaluates `ch != 'C'`, which evaluates to true. Detecting that the expression is true, conditional AND evaluates `ch != 'c'`, which evaluates to false. Once again, the while statement terminates.

**Note** A for statement can be coded as a while statement. For example,

```
for (int i = 0; i < 10; i++)
    System.out.println(i);
```

is equivalent to

```
int i = 0;
while (i < 10)
{
    System.out.println(i);
    i++;
}
```

## Do-While Statement

The *do-while statement* repeatedly executes a statement while its Boolean expression evaluates to true. Unlike while, which evaluates the Boolean expression at the top of the loop, do-while evaluates the Boolean expression at the bottom of the loop. It has the following syntax:

```
do
    statement
while (Boolean expression);
```

This statement consists of the *do* reserved word, followed by a *statement* to execute repeatedly, followed by the *while* reserved word, followed by a parenthesized *Boolean expression*, followed by a semicolon.

The do-while statement first executes the other *statement*. It then evaluates the *Boolean expression*. If it's true, do-while executes the other *statement*. Once again, the *Boolean expression* is evaluated. If it's still true, do-while re-executes the *statement*. This cyclic pattern continues.

The following example demonstrates do-while prompting the user to enter a specific uppercase letter or its lowercase equivalent:

```
int ch;
do
{
    System.out.println("Press C or c to continue.");
    ch = System.in.read();
}
while (ch != 'C' && ch != 'c');
```

This example is similar to its predecessor. Because the compound statement is no longer executed before the test, it's no longer necessary to initialize *ch*—*ch* is assigned `System.in.read()`'s return value before the Boolean expression's evaluation.



## Looping Over the Empty Statement

Java refers to a semicolon character appearing by itself as the *empty statement*. It's sometimes convenient for a loop statement to execute the empty statement repeatedly. The actual work performed by the loop statement takes place in the statement header.

Consider the following example:

```
for (String line; (line = readLine()) != null; System.out.println(line));
```

This example uses `for` to present a programming idiom for copying lines of text that are read from some source, via the fictitious `readLine()` method in this example, to some destination, via `System.out.println()` in this example. Copying continues until `readLine()` returns null. Note the semicolon (empty statement) at the end of the line.

**Caution** Be careful with the empty statement because it can introduce subtle bugs into your code. For example, the following loop is supposed to output the string `Hello` on 10 lines. Instead, only one instance of this string is output, because it's the empty statement and not `System.out.println()` that's executed 10 times:

```
for (int i = 0; i < 10; i++); // this ; represents the empty statement
    System.out.println("Hello");
```

## Break and Labeled Break Statements

What do `for (;;)`, `while (true);` and `do;while (true);` have in common? Each of these loop statements presents an extreme example of an *infinite loop* (a loop that never ends). An infinite loop is something that you should avoid because its unending execution causes your application to hang, which isn't desirable from the point of view of your application's users.

**Caution** An infinite loop can also arise from a loop's Boolean expression comparing a floating-point value with a nonzero value via the equality or inequality operator, because many floating-point values have inexact internal representations. For example, the following example never ends because `0.1` doesn't have an exact internal representation:

```
for (double d = 0.0; d != 1.0; d += 0.1)
    System.out.println(d);
```

However, there are times when it's handy to code a loop as if it were infinite by using one of the aforementioned programming idioms. For example, you might code a `while (true)` loop that repeatedly prompts for a specific keystroke until the correct key is pressed. When the correct key is pressed, the loop must end. Java provides the `break` statement for this purpose.

The *break statement* transfers execution to the first statement following a switch statement (as discussed earlier) or a loop. In either scenario, this statement consists of reserved word `break` followed by a semicolon.

The following example uses `break` with an if decision statement to exit a while (true)-based infinite loop when the user presses the C or c key:

```
int ch;
while (true)
{
    System.out.println("Press C or c to continue.");
    ch = System.in.read();
    if (ch == 'C' || ch == 'c')
        break;
}
```

The `break` statement is also useful in the context of a finite loop. For example, consider a scenario where an array of values is searched for a specific value, and you want to exit the loop when this value is found. Listing 2-16 presents an `EmployeeSearch` application that demonstrates this scenario.

*Listing 2-16. Searching for a Specific Employee ID*

```
public class EmployeeSearch
{
    public static void main(String[] args)
    {
        int[] employeeIDs = { 123, 854, 567, 912, 224 };
        int employeeSearchID = 912;
        boolean found = false;
        for (int i = 0; i < employeeIDs.length; i++)
            if (employeeSearchID == employeeIDs[i])
                {
                    found = true;
                    break;
                }
        System.out.println((found) ? "employee " + employeeSearchID + " exists"
                               : "no employee ID matches " + employeeSearchID);
    }
}
```

Listing 2-16 uses `for` and `if` statements to search an array of employee IDs to determine if a specific employee ID exists. If this ID is found, its compound statement assigns `true` to `found`. Because there's no point in continuing the search, it then uses `break` to quit the loop.

Compile Listing 2-16 as follows:

```
javac EmployeeSearch.java
```

Run this application as follows:

```
java EmployeeSearch
```

You should observe the following output:

```
employee 912 exists
```

The *labeled break statement* transfers execution to the first statement following the loop that's prefixed by a *label* (an identifier followed by a colon). It consists of reserved word `break`, followed by an identifier for which the matching label must exist. Furthermore, the label must immediately precede a loop statement.

The labeled break is useful for breaking out of *nested loops* (loops within loops). The following example reveals the labeled break statement transferring execution to the first statement that follows the outer for loop:

```
outer:
for (int i = 0; i < 3; i++)
    for (int j = 0; j < 3; j++)
        if (i == 1 && j == 1)
            break outer;
        else
            System.out.println("i=" + i + ", j=" + j);
System.out.println("Both loops terminated.");
```

When `i`'s value is 1 and `j`'s value is 1, `break outer;` is executed to terminate both for loops. This statement transfers execution to the first statement after the outer for loop, which happens to be `System.out.println("Both loops terminated.");`.

The following output is generated:

---

```
i=0, j=0
i=0, j=1
i=0, j=2
i=1, j=0
Both loops terminated.
```

---

## Continue and Labeled Continue Statements

The *continue statement* skips the remainder of the current loop iteration, re-evaluates the loop's Boolean expression, and performs another iteration (if true) or terminates the loop (if false). Continue consists of reserved word `continue` followed by a semicolon.

Consider a while loop that reads lines from a source and processes nonblank lines in some manner. Because it shouldn't process blank lines, while skips the current iteration when a blank line is detected, as demonstrated in the following example:

```
String line;
while ((line = readLine()) != null)
{
    if (isBlank(line))
        continue;
    processLine(line);
}
```

This example employs a fictitious `isBlank()` method to determine if the currently read line is blank. If this method returns true, it executes the `continue` statement to skip the rest of the current iteration and read the next line whenever a blank line is detected. Otherwise, the fictitious `processLine()` method is called to process the line's contents.

Look carefully at this example, and you should realize that the `continue` statement isn't needed. Instead, this listing can be shortened via *refactoring* (rewriting source code to improve its readability, organization, or reusability), as demonstrated in the following example:

```
String line;
while ((line = readLine()) != null)
{
    if (!isBlank(line))
        processLine(line);
}
```

This example's refactoring modifies `if`'s Boolean expression to use the logical complement operator (`!`). Whenever `isBlank()` returns false, this operator flips this value to true and it executes `processLine()`. Although `continue` isn't necessary in this example, you'll find it convenient to use this statement in more complex code where refactoring isn't as easy to perform.

The *labeled continue statement* skips the remaining iterations of one or more nested loops and transfers execution to the labeled loop. It consists of reserved word `continue`, followed by an identifier for which a matching label must exist. Furthermore, the label must immediately precede a loop statement.

Labeled `continue` is useful for breaking out of nested loops while still continuing to execute the labeled loop. The following example reveals the labeled `continue` statement terminating the inner `for` loop's iterations:

```
outer:
for (int i = 0; i < 3; i++)
    for (int j = 0; j < 3; j++)
        if (i == 1 && j == 1)
            continue outer;
        else
            System.out.println("i=" + i + ", j=" + j);
System.out.println("Both loops terminated.");
```

When `i`'s value is 1 and `j`'s value is 1, `continue outer;` is executed to terminate the inner `for` loop and continue with the outer `for` loop at its next value of `i`. Both loops continue until they finish.

The following output is generated:

---

```
i=0, j=0
i=0, j=1
i=0, j=2
i=1, j=0
i=2, j=0
i=2, j=1
i=2, j=2
Both loops terminated.
```

---

---

**EXERCISES**

The following exercises are designed to test your understanding of Chapter 2's content.

1. What is Unicode?
2. What is a comment?
3. Identify the three kinds of comments that Java supports.
4. What is an identifier?
5. True or false: Java is a case-insensitive language.
6. What is a type?
7. Define primitive type.
8. Identify all of Java's primitive types.
9. Define user-defined type.
10. Define array type.
11. What is a variable?
12. What is an expression?
13. Identify the two expression categories.
14. What is a literal?
15. Is string literal "The quick brown fox \jumps\ over the lazy dog." legal or illegal? Why?
16. What is an operator?
17. Identify the difference between a prefix operator and a postfix operator.
18. What is the purpose of the cast operator?
19. What is precedence?
20. True or false: Most of Java's operators are left-to-right associative.
21. What is a statement?
22. What is the difference between the while and do-while statements?
23. What is the difference between the break and continue statements?
24. Write a `Compass` application (the class is named `Compass`) whose `main()` method encapsulates the direction-oriented switch statement example presented earlier in this chapter. You'll need to declare a `direction` variable with the appropriate type and initialize this variable.

25. Create a `Triangle` application whose `Triangle` class's `main()` method uses a pair of nested for statements along with `System.out.print()` to output a 10-row triangle of asterisks, where each row contains an odd number of asterisks (1, 3, 5, 7, and so on), as shown below:

```
*
***
*****
*****
*****
*****
*****
*****
*****
*****
*****
```

Compile and run this application.

26. Write a pair of `PromptForC` applications whose `main()` methods encapsulate the while and do-while examples that prompt for input of letter `c` or letter `C`. Because each method uses `System.in.read()` to obtain input, append throws `java.io.Exception` to the `main()` method header.
- 

## Summary

Before developing Java applications, you need to understand the structure of a Java application. Essentially, every application drills down to a single class that declares a public static void `main(String[] args)` method.

Source code needs to be documented so that you (and any others who have to maintain it) can understand it, now and later. Java provides the comment feature for embedding documentation in source code. Single-line, multiline, and documentation comments are supported.

A single-line comment occupies all or part of a single line of source code. This comment begins with the `//` character sequence and continues with explanatory text. The compiler ignores everything from `//` to the end of the line in which `//` appears.

A multiline comment occupies one or more lines of source code. This comment begins with the `/*` character sequence, continues with explanatory text, and ends with the `*/` character sequence. Everything from `/*` through `*/` is ignored by the compiler.

A Javadoc comment occupies one or more lines of source code. This comment begins with the `/**` character sequence, continues with explanatory text, and ends with the `*/` character sequence. Everything from `/**` through `*/` is ignored by the compiler.

Identifiers are used to name classes, methods, and other source code entities. An identifier consists of letters (A-Z, a-z, or equivalent uppercase/lowercase letters in other human alphabets), digits (0-9 or equivalent digits in other human alphabets), connecting punctuation characters (such as the underscore), and currency symbols (such as the dollar sign, \$). This name must begin with a letter, a currency symbol, or a connecting punctuation character; and its length cannot exceed the line in which it appears. Some identifiers are reserved by Java. Examples include `abstract` and `case`.

Applications process different types of values such as integers, floating-point values, characters, and strings. A type identifies a set of values (and their representation in memory) and a set of operations that transform these values into other values of that set.

A primitive type is a type that's defined by the language and whose values are not objects. Java supports the Boolean, character, byte integer, short integer, integer, long integer, floating-point, and double precision floating-point primitive types.

A user-defined type is a type that's defined by the developer using a class, an interface, an enum, or an annotation type and whose values are objects. User-defined types are also known as reference types.

An array type is a reference type that signifies an array, a region of memory that stores values in equal-size and contiguous slots, which are commonly referred to as elements. This type consists of the element type and one or more pairs of square brackets that indicate the number of dimensions.

Applications manipulate values that are stored in memory, which is symbolically represented in source code through the use of the variables feature. A variable is a named memory location that stores some type of value.

Java provides the expressions feature for initializing variables and for other purposes. An expression combines some arrangement of literals, variable names, method calls, and operators. At runtime, it evaluates to a value whose type is referred to as the expression's type.

A simple expression is a literal, a variable name (containing a value), or a method call (returning a value). Java supports several kinds of literals: string, Boolean `true` and `false`, character, integer, floating-point, and `null`.

A compound expression is a sequence of simple expressions and operators, where an operator (a sequence of instructions symbolically represented in source code) transforms its operand expression value(s) into another value.

Java supplies many operators, which are classified by the number of operands that they take. A unary operator takes only one operand, a binary operator takes two operands, and Java's single ternary operator takes three operands.

Operators are also classified as prefix, postfix, and infix. A prefix operator is a unary operator that precedes its operand, a postfix operator is a unary operator that trails its operand, and an infix operator is a binary or ternary operator that's sandwiched between its operands.

Statements are the workhorses of a program. They assign values to variables, control a program's flow by making decisions and/or repeatedly executing other statements, and perform other tasks. A statement can be expressed as a simple statement or as a compound statement.

In Chapter 3, I continue to explore the Java language by examining its support for classes and objects. You also learn more about arrays.

# Discovering Classes and Objects

In Chapter 2, I introduced you to the fundamentals of the Java language. You now know how to write simple applications by inserting statements into a class's `main()` method. However, when you try to develop complex applications in this manner, you're bound to find development tedious, slow, and prone to error. Classes and objects address these problems by simplifying application architecture.

In this chapter, I will introduce you to Java's support for classes and objects. You will learn how to declare classes, construct objects from classes, encapsulate fields and methods in classes, restrict access to fields and methods, initialize classes and objects to appropriate startup values, and remove objects that are no longer needed.

In Chapter 2, I introduced you to arrays. You learned about array types and how to declare array variables, and you discovered a simple way to create an array. However, Java also provides a more powerful and more flexible way to create arrays, which is somewhat similar to how objects are created. This chapter also extends Chapter 2's array coverage by introducing you to this capability.

## Declaring Classes

A *class* is a container for housing an application (as demonstrated in Chapters 1 and 2), and it is also a template for manufacturing objects, which I discuss later in this chapter.

You declare a class by minimally specifying reserved word `class` followed by a name that identifies the class (so that it can be referred to from elsewhere in the source code), followed by a body. The body starts with an open brace character (`{`) and ends with a close brace (`}`). Sandwiched between these delimiters are various kinds of member declarations. Consider Listing 3-1.

*Listing 3-1. Declaring a Skeletal Image Class*

```
class Image
{
    // various member declarations
}
```



Listing 3-1 declares a class named `Image`, which presumably describes some kind of image for displaying on the screen. By convention, a class's name, which must be a valid Java identifier, begins with an uppercase letter. Furthermore, the first letter of each subsequent word in a multiword class name is capitalized. This is known as *camel casing*.

You can choose any name for the file containing Listing 3-1, as long as the file extension is `.java`; a Java source file must have this extension. However, if you prefixed this declaration with reserved word `public` (see Listing 3-2), the filename would have to match the class name or else the compiler would report an error. (Public classes are accessible from beyond their packages; see Chapter 5.)

*Listing 3-2. Declaring a Public Skeletal SavingsAccount Class*

```
public class SavingsAccount
{
    // various member declarations
}
```

Unlike Listing 3-1, which can be stored in `Image.java`, `x.java`, or some other named file with a `.java` file extension, Listing 3-2 must be stored in a file named `SavingsAccount.java`.

You can declare multiple classes in the same file, which Listing 3-3 demonstrates.

*Listing 3-3. Declaring Three Classes in the Same File*

```
class A
{
    // various member declarations
}

class B
{
    // various member declarations
}

class C
{
    // various member declarations
}
```

Listing 3-3 declares classes A, B, and C. You can store this listing in `A.java`, `B.java`, `c.java` (case doesn't matter), `D.java`, or any other named file with a `.java` file extension.

If a source file contains multiple class declarations, you can declare at most one of these classes to be a public class. For example, Listing 3-4 is a variation of Listing 3-3 where B is declared `public`.

*Listing 3-4. Declaring Three Classes Where One Class is Public in the Same File*

```
class A
{
    // various member declarations
}

public class B
{
    // various member declarations
}

class C
{
    // various member declarations
}
```

Listing 3-4 must be stored in a file named B.java.

## Classes and Applications

In Chapter 2, I discussed application structure in terms of a public static void main(String[] args) method declared in a class. However, an application can consist of multiple classes and each class can declare its own main() method, which is demonstrated in Listing 3-5.

*Listing 3-5. Declaring Three Classes with Their Own main() Methods*

```
class A
{
    public static void main(String[] args)
    {
        // statements to execute
    }
}

class B
{
    public static void main(String[] args)
    {
        // statements to execute
    }
}

class C
{
    public static void main(String[] args)
    {
        // statements to execute
    }
}
```

Suppose Listing 3-5 was stored in `App.java`. You would compile this source file as follows:

```
javac App.java
```

You could then run the `main()` methods by executing the following commands:

```
java A
java B
java C
```

Does class A describe the application? How about class B, or even class C? This is certainly confusing. When you're building a multiclass application and you're new to Java, it's best to declare a `main()` method in only one of its classes. That class would serve as the application's entry point.

## Constructing Objects

`Image`, `SavingsAccount`, `A`, `B`, and `C` are examples of user-defined types from which *objects* (class instances) can be created. You create these objects by using the `new` operator with a *constructor*, which is a block of code that's declared in a class for constructing an object from that class by initializing it in some manner.

Object creation has the following syntax:

```
new constructor
```

The `new` operator allocates memory to store the object whose type is specified by *constructor* and then *invokes* (calls) *constructor* to initialize the object, which is stored in the *heap* (a region of memory for storing objects). When *constructor* ends, `new` returns a *reference* (a memory address or other identifier) to the object so that it can be accessed elsewhere in the application.

The constructor has the following syntax:

```
class_name(parameter_list)
{
    // statements to execute
}
```

Unlike in a method declaration (discussed later in this chapter), a constructor doesn't begin with a return type because it cannot return a value to `new`, which calls the constructor. If a constructor could return an arbitrary value, how would Java return that value? After all, the `new` operator returns a reference to an object, and how could `new` also return a constructor value?

A constructor doesn't have a name. Instead, you must specify the name of the class that declares the constructor. This name is followed by a round bracket-delimited *parameter list*, which is a comma-separated list of zero or more parameter declarations. A *parameter* is a constructor or method variable that receives an expression value passed to the constructor or method when it's called. This expression value is known as an *argument*.

**Note** The number of arguments passed to a constructor or method, or the number of operator operands, is known as the constructor's, method's, or operator's *arity*.

Consider the following example:

```
Image image = new Image();
```

The new operator allocates memory to store an Image object in the heap. It then invokes a constructor with no parameters—a *noargument constructor*—to initialize this object. Following initialization, new returns a reference to the newly-initialized Image object. The reference is stored in a variable named image whose type is specified as Image. (It's common to refer to the variable as an object, as in the image object, although it stores only an object's reference and not the object itself.)

**Note** new's returned reference is represented in source code by reserved word this. Wherever this appears, it represents the current object. Also, variables that store references are called *reference variables*.

## Default Constructor

Image doesn't explicitly declare a constructor. When a class doesn't declare a constructor, Java implicitly creates a constructor for that class. The created constructor is known as the *default noargument constructor* because no arguments (demonstrated shortly) appear between its ( and ) characters when the constructor is invoked.

**Note** Java doesn't create a default noargument constructor when at least one constructor is declared.

## Explicit Constructors

You can explicitly declare a constructor within a class's body. For example, Listing 3-6 enhances Listing 3-1's Image class by declaring a single constructor with an empty parameter list.

*Listing 3-6. Declaring an Image Class with a Single Constructor*

```
class Image
{
    Image()
    {
        System.out.println("Image() called");
    }
}
```

Listing 3-6's Image class declares a noargument constructor for initializing an Image object. The declaration consists of a class named Image followed by round brackets. This constructor simulates default initialization. It does so by invoking `System.out.println()` to output a message signifying that it's been called.

As previously shown with the default noargument constructor, you would create an object from this class by executing a statement such as the following:

```
Image image = new Image();
```

The constructor would execute the `System.out.println()` method call, which results in the following output:

```
Image() called
```

You will often declare constructors with nonempty parameter lists. Listing 3-7 demonstrates this scenario by declaring an Image class with a pair of constructors.

*Listing 3-7. Declaring an Image Class with Two Constructors*

```
class Image
{
    Image(String filename)
    {
        this(filename, null);
        System.out.println("Image(String filename) called");
    }

    Image(String filename, String imageType)
    {
        System.out.println("Image(String filename, String imageType) called");
        if (filename != null)
        {
            System.out.println("reading " + filename);
            if (imageType != null)
                System.out.println("interpreting " + filename + " as storing a " +
                    imageType + " image");
        }
        // Perform other initialization here.
    }
}
```

Listing 3-7's Image class first declares an `Image(String filename)` constructor whose parameter list consists of a single *parameter declaration*—a variable's type followed by the variable's name. The `java.lang.String` parameter is named `filename`, signifying that this constructor obtains image content from a file.

**Note** Throughout this and the remaining chapters, I typically prefix the first use of a predefined type (such as `String`) with the package hierarchy in which the type is stored. For example, `String` is stored in the `lang` subpackage of the `java` package. I do so to help you learn where types are stored in the standard class library. I will have more to say about packages in Chapter 5.

`Image(String filename)` demonstrates that some constructors rely on other constructors to help them initialize their objects. This is done to avoid redundant code, which increases the size of an object and unnecessarily takes memory away from the heap that could be used for other purposes. For example, `Image(String filename)` relies on `Image(String filename, String imageType)` to read the file's image content into memory.

Although it appears otherwise, constructors don't have names (however, it's common to refer to a constructor by specifying the class name and parameter list). A constructor calls another constructor by using keyword `this` and a round bracket-delimited and comma-separated list of arguments. For example, `Image(String filename)` executes `this(filename, null)`; to execute `Image(String filename, String imageType)`.

**Caution** You must use keyword `this` to call another constructor; you cannot use the class's name, as in `Image()`. The `this()` constructor call (when present) must be the first code that's executed within the constructor. This rule prevents you from specifying multiple `this()` constructor calls in the same constructor. Finally, you cannot specify `this()` in a method; constructors can be called only by other constructors and during object creation. (I discuss methods later in this chapter.)

When present, the constructor call must be the first code that's specified within a constructor; otherwise, the compiler reports an error. For this reason, a constructor that calls another constructor can perform additional work only after the other constructor has finished. For example, `Image(String filename)` executes `System.out.println("Image(String filename) called")`; after the invoked `Image(String filename, String imageType)` constructor finishes.

The `Image(String filename, String imageType)` constructor declares an `imageType` parameter that signifies the kind of image stored in the file—a Portable Network Graphics (PNG) image, for example. Presumably, the constructor uses `imageType` to speed up processing by not examining the file's contents to learn the image format. When `null` is passed to `imageType`, as happens with the `Image(String filename)` constructor, `Image(String filename, String imageType)` examines file content to learn the format. If `null` was also passed to `filename`, `Image(String filename, String imageType)` wouldn't read the file but would presumably notify the code attempting to create the `Image` object of an error condition.

The following example shows you how to create two `Image` objects, calling the first constructor with argument `"image.png"` and the second constructor with arguments `"image.png"` and `"PNG"`. Each object's reference is assigned to a reference variable named `image`, replacing the previously stored reference for the second object assignment:

```
Image image = new Image("image.png");
image = new Image("image.png", "PNG");
```

These constructor calls result in the following output:

```
Image(String filename, String imageType) called
reading image.png
Image(String filename) called
Image(String filename, String imageType) called
reading image.png
interpreting image.png as storing a PNG image
```

In addition to declaring parameters, a constructor can also declare variables within its body to help it perform various tasks. For example, the previously presented `Image(String filename, String imageType)` constructor might create an object from a (hypothetical) `File` class that provides the means to read a file's contents. At some point, the constructor instantiates this class and assigns the instance's reference to a variable, as demonstrated by the following example:

```
Image(String filename, String imageType)
{
    System.out.println("Image(String filename, String imageType) called");
    if (filename != null)
    {
        System.out.println("reading " + filename);
        File file = new File(filename);
        // Read file contents into object.
        if (imageType != null)
            System.out.println("interpreting " + filename + " as storing a " +
                imageType + " image");
        else
            // Inspect image contents to learn image type.
            ; // Empty statement is used to make if-else syntactically valid.
    }
    // Perform other initialization here.
}
```

As with the `filename` and `imageType` parameters, `file` is a variable that's local to the constructor, and it is known as a *local variable* to distinguish it from a parameter. Although all three variables are local to the constructor, there are two key differences between parameters and local variables:

- The `filename` and `imageType` parameters come into existence at the point where the constructor begins to execute and exist until execution leaves the constructor. In contrast, `file` comes into existence at its point of declaration and continues to exist until the block in which it's declared is terminated (via a closing brace character). This property of a parameter or a local variable is known as *lifetime*.
- The `filename` and `imageType` parameters can be accessed from anywhere in the constructor. In contrast, `file` can be accessed only from its point of declaration to the end of the block in which it's declared. It cannot be accessed before its declaration or after its declaring block, but nested sub-blocks can access the local variable. This property of a parameter or a local variable is known as *scope*.

## Objects and Applications

You previously learned that you can declare a `public static void main(String[] args)` entry-point method in any class. Also, it can be confusing to declare this method in every class of a multiclass application because your application's users won't know which class is the application entry point.

Sometimes, you'll want to declare `main()` in multiple classes for testing purposes. You can then test that class independently of the other classes that make up the application. Alternatively, you might decide to perform unit testing ([http://en.wikipedia.org/wiki/Unit\\_testing](http://en.wikipedia.org/wiki/Unit_testing)) on your classes.

Listing 3-8 presents a three-class application that demonstrates multiclass testing.

*Listing 3-8. Testing an Application's Component Classes*

```
class Circle
{
    Circle()
    {
        System.out.println("Circle() called");
    }

    public static void main(String[] args)
    {
        new Circle();
    }
}

class Rectangle
{
    Rectangle()
    {
        System.out.println("Rectangle() called");
    }
}
```



```
public static void main(String[] args)
{
    new Rectangle();
}

public class Shapes
{
    public static void main(String[] args)
    {
        Circle c = new Circle();
        Rectangle r = new Rectangle();
    }
}
```

Listing 3-8 declares three classes: `Circle`, `Rectangle`, and `Shapes`. Unlike `Circle` and `Rectangle`, `Shapes` is declared `public`. Because `Shapes` is `public` and all three classes are declared in the same source file, the name of this source file is `Shapes.java`.

Each class declares a `main()` method. However, the main application class is `Shapes` because it demonstrates `Circle` and `Rectangle`, which are components of the application. To identify an application's main class in a multiclass application, I declare the main class `public`.

You would execute the following command to compile `Shapes.java`:

```
javac Shapes.java
```

To run the `Shapes` application, you would execute the following command:

```
java Shapes
```

You can also run the `Circle` and `Rectangle` component classes to test that these components work properly:

```
java Circle
java Rectangle
```

When you're finished testing the component classes, you should probably remove the `main()` methods from them to avoid confusion on the part of anyone studying your code. Alternatively, you could document these methods via comments and clearly document the entry-point class.

## Encapsulating State and Behaviors

Classes typically combine state with behaviors. *State* refers to *attributes* (such as a counter set to 1 or an account balance storing \$20,000) that are read and/or written when an application runs, and *behaviors* refer to sequences of code (such as calculate a specific factorial or make a deposit into a savings account) that read/write attributes and perform other tasks. Combining state with behaviors is known as *encapsulation*.

## Representing State via Fields

Java represents state via *fields*, which are variables declared within a class's body. State associated with a class is described by class fields, whereas state associated with objects is described by *object fields* (also known as *instance fields*).

**Note** By convention, a field's name begins with a lowercase letter, and the first letter of each subsequent word in a multiword field name is capitalized.

## Declaring and Accessing Class Fields

A class field stores an attribute that's associated with a class. All objects created from that class share this class field. When one object modifies the field's value, the new value is visible to all current and future objects created from that class.

You declare a class field by specifying the following syntax:

```
static type_name variable_name [ = expression ] ;
```

A class field declaration begins with the `static` reserved word. This reserved word is followed by a type name and a variable name. You can optionally end the declaration by assigning a type-compatible expression, which is known as a *class field initializer*, to the variable name. Don't forget to specify the trailing semicolon character.

For example, suppose you declare a `Car` class and want to keep track of the number of objects that are created from this class. To accomplish this task, you introduce a `counter` class field (initialized to 0) into this class. Check out Listing 3-9.

*Listing 3-9. Adding a counter Class Field to a Car Class*

```
class Car
{
    static int counter = 0;

    Car()
    {
        counter++;
    }
}
```

Listing 3-9 declares an `int` class field named `counter`. The `static` prefix implies that there is only one copy of this field and not one copy per object. This `counter` field is explicitly initialized to 0. Each time an object is created, the `counter++` expression in the `Car()` constructor increases `counter` by 1.

Listing 3-10 presents a `Cars` application class that demonstrates `Car` and `counter`.

*Listing 3-10. Demonstrating the Car Class and Its counter Field*

```
public class Cars
{
    public static void main(String[] args)
    {
        System.out.println(Car.counter);
        Car myCar = new Car();
        System.out.println(Car.counter);
        Car yourCar = new Car();
        System.out.println(Car.counter);
    }
}
```

Compile Listing 3-10 as follows. Listing 3-9 is also compiled because `Cars` references `Car`.

```
javac Cars.java
```

Run the `Cars` application as follows:

```
java Cars
```

You should observe the following output, which reveals `counter`'s initial value and that this variable is incremented for each created `Car` object:

---

```
0
1
2
```

---

It isn't necessary to explicitly initialize `counter` to 0. When a class is loaded into memory, class fields are initialized to default zero/false/null values. For example, `counter` is implicitly initialized to 0.

**Note** Class fields are initialized by zeroing their bits. You interpret this value as literal `false`, `'\u0000'`, `0.0`, `0.0f`, `0.0L`, or `null` depending on the field's type.

Within a class declaration, a class field is accessed directly, as in `counter++`. When accessing a class field from outside of the class, you must prepend the class name followed by the member access operator to the class field name. For example, to access `counter` from `Cars`, you must specify `Car.counter`.

**Note** I could have accessed `counter` via the `myCar` and `yourCar` reference variables, for example, `myCar.counter` and `yourCar.counter`. However, the preferred approach is to use the class name, as in `Car.counter`. This approach is preferred because it's easier to tell that a class field is being accessed.

Class fields can be modified. If you want a class field to be *constant* (an unchangeable variable), you must declare the class field to be *final* by prefixing its declaration with the `final` reserved word. Listing 3-11 presents an example.

*Listing 3-11. Declaring a Constant in the Employee class*

```
class Employee
{
    final static int RETIREMENT_AGE = 65;
}
```

Listing 3-11 declares an integer constant named `RETIREMENT_AGE`. If you attempt to modify this variable subsequently, as in `RETIREMENT_AGE = 32;`, the compiler reports an error. Although reserved word `final` precedes reserved word `static` in this example, you can switch this order, which results in `static final int RETIREMENT_AGE = 65;`.

The `RETIREMENT_AGE` declaration is an example of a *compile-time constant*. Because there is only one copy of its value (because of `static`), and because this value will never change (thanks to `final`), the compiler can optimize the bytecode by inserting the constant value into all calculations where it appears. Code runs faster because it doesn't have to access a read-only class field.

A class field is created when the class that declares this field is loaded into the heap. The class field is destroyed when the class is unloaded, typically when the virtual machine ends. This property of a class field is known as *lifetime*.

A class field is visible to the entire class in which it's declared. In other words, the class field can be accessed from anywhere in its class. Unless explicitly hidden (discussed later in this chapter), the class field is visible to code outside of the class. This property of a class field is known as *scope*.

## Declaring and Accessing Instance Fields

An instance field stores an attribute that's associated with an object. Each object maintains a separate copy of the attribute. For example, one object might have red as its color attribute, whereas a second object has green as its color attribute.

You declare an instance field by specifying the following syntax:

```
type_name variable_name [ = expression ] ;
```

An instance field declaration begins with a type name followed by a variable name. You can optionally end the declaration by assigning a type-compatible expression, which is known as an *instance field initializer*, to the variable name. Don't forget to specify the trailing semicolon character.

For example, you want to model a car in terms of its make, model, and number of doors. You don't use class fields to store these attributes because cars have different makes, models, and door counts. Listing 3-12 presents a `Car` class with three instance field declarations for these attributes.

*Listing 3-12. Declaring a Car Class with make, model, and numDoors Instance Fields*

```
class Car
{
    String make;
    String model;
    int numDoors;
}
```

Listing 3-12 declares two `String` instance fields named `make` and `model`. It also declares an `int` instance field named `numDoors`.

When an object is created, instance fields are initialized to default zero values, which you interpret at the source code level as literal value `false`, `'\u0000'`, `0`, `0L`, `0.0`, `0.0F`, or `null` (depending on field type). For example, if you executed `Car car = new Car();`, `make` and `model` would be initialized to `null` and `numDoors` would be initialized to `0`.

Listing 3-13 presents the source code to a `Cars` application class that directly accesses its instance fields.

*Listing 3-13. Directly Accessing Instance Fields*

```
public class Cars
{
    public static void main(String[] args)
    {
        Car myCar = new Car();
        myCar.make = "Toyota";
        myCar.model = "Camry";
        myCar.numDoors = 4;
        System.out.println("Make = " + myCar.make);
        System.out.println("Model = " + myCar.model);
        System.out.println("Number of doors = " + myCar.numDoors);
    }
}
```

Compile Listing 3-13 as follows:

```
javac Cars.java
```

Run the `Cars` application as follows:

```
java Cars
```

You should observe the following output, which reveals the values assigned to the `Car` object's `make`, `model`, and `numDoors` instance fields:

---

```
Make = Toyota
Model = Camry
Number of doors = 4
```

---

In a class declaration, an instance field is accessed directly, as in `System.out.println(numDoors);`. When accessing an instance field from outside of an object, you must prepend the desired object reference variable followed by the member access operator to the instance field name. For example, I specified `myCar.make` to access the `make` field of the `myCar` object in Listing 3-13.

You can explicitly initialize an instance field when declaring that field to provide a nonzero default value, which overrides the default zero value. Listing 3-14 demonstrates this point.

*Listing 3-14. Initializing Car's numDoors Instance Field to a Default Nonzero Value*

```
class Car
{
    String make;
    String model;
    int numDoors = 4;
}
```

Listing 3-14 explicitly initializes `numDoors` to 4 because the developer has assumed that most cars being modeled by this class have four doors. When `Car` is initialized via the default noargument `Car()` constructor, which is responsible for assigning 4 to `numDoors`, the developer only needs to initialize the `make` and `model` instance fields for those cars that have four doors.

You could remove the `myCar.numDoors = 4;` assignment from Listing 3-13, and you would still observe the same output.

It's usually not a good idea to directly initialize an object's instance fields, and you will learn why when I discuss information hiding later in this chapter. Instead, you should perform this initialization in the class's constructor(s); see Listing 3-15.

*Listing 3-15. Initializing Car's Instance Fields via Constructors*

```
class Car
{
    String make;
    String model;
    int numDoors;

    Car(String make, String model)
    {
        this(make, model, 4);
    }

    Car(String make, String model, int nDoors)
    {
        this.make = make;
        this.model = model;
        numDoors = nDoors;
    }
}
```

Listing 3-15's `Car` class declares `Car(String make, String model)` and `Car(String make, String model, int nDoors)` constructors. The first constructor lets you specify make and model, whereas the second constructor lets you specify values for the three instance fields.

The first constructor executes `this(make, model, 4)`; to pass the values of its `make` and `model` parameters, along with a default value of 4 to the second constructor. Doing so demonstrates an alternative to initializing an instance field explicitly, and it is preferable from a code maintenance perspective.

The `Car(String make, String model, int numDoors)` constructor demonstrates another use for keyword `this`. Specifically, it demonstrates a scenario where constructor parameters have the same names as the class's instance fields. Prefixing a variable name with `this.` causes the Java compiler to create bytecode that accesses the instance field. For example, `this.make = make;` assigns the `make` parameter's `String` object reference to `this` (the current) `Car` object's `make` instance field. If `make = make;` was specified instead, it would accomplish nothing by assigning `make`'s value to itself; a Java compiler might not generate code to perform the unnecessary assignment. In contrast, `this.` isn't necessary for the `numDoors = nDoors;` assignment, which initializes the `numDoors` field from the `nDoors` parameter value.

**Note** To minimize error (by forgetting to prefix a field name with `this.`), it's preferable to keep field names and parameter names distinct (such as `numDoors` and `nDoors`). Alternatively, you might prefix a field name with an underscore (such as `_nDoors`). Either way, you wouldn't have to worry about the `this.` prefix (and forgetting to specify it).

Listing 3-16 demonstrates instance field initialization via these constructors.

*Listing 3-16. Demonstrating Instance Field Initialization via Constructors*

```
public class Cars
{
    public static void main(String[] args)
    {
        Car myCar = new Car("Toyota", "Camry");
        System.out.println("Make = " + myCar.make);
        System.out.println("Model = " + myCar.model);
        System.out.println("Number of doors = " + myCar.numDoors);
        System.out.println();
        Car yourCar = new Car("Mazda", "RX-8", 2);
        System.out.println("Make = " + yourCar.make);
        System.out.println("Model = " + yourCar.model);
        System.out.println("Number of doors = " + yourCar.numDoors);
    }
}
```

Compile Listing 3-16 as follows:

```
javac Cars.java
```

Run the Cars application as follows:

```
java Cars
```

You should observe the following output, which reveals that each of the `myCar` and `yourCar` objects has different instance field values:

---

```
Make = Toyota
Model = Camry
Number of doors = 4
```

```
Make = Mazda
Model = RX-8
Number of doors = 2
```

---

Instance fields can be modified. If you want an instance field to be constant, you must declare the instance field to be `final` by prefixing its declaration with the `final` reserved word. Listing 3-17 presents an example.

*Listing 3-17. Declaring a Constant in the Employee class*

```
class Employee
{
    final int RETIREMENT_AGE = 65;
}
```

Listing 3-17 declares an integer constant named `RETIREMENT_AGE`. If you attempt to modify this variable subsequently, which you can only do in an object context (such as `emp.RETIREMENT_AGE = 32;`), the compiler reports an error.

Each object receives a copy of a read-only instance field. Regarding Listing 3-17, each `Employee` object would receive a copy of `RETIREMENT_AGE`. Because this is wasteful of memory, you would be better off also declaring `RETIREMENT_AGE` to be `static` so that there is only one copy.

A `final` instance field must be initialized, as part of the field's declaration or in the class's constructor. When initialized in the constructor, the read-only instance field is known as a *blank final* because it doesn't have a value (the field is blank) until one is assigned to it in the constructor. Because a constructor can potentially assign a different value to each object's blank `final`, these read-only variables are only true constants in the contexts of their objects. Check out Listing 3-18.

*Listing 3-18. Declaring a Different Constant for Each Employee class*

```
class Employee
{
    final int ID;

    static int counter;
```



```

Employee()
{
    ID = counter++;
}
}

```

Each `Employee` object receives a different read-only ID value.

An instance field is created when an object is created from the class that declares this field. The instance field is destroyed when the object is garbage collected. (I discuss garbage collection later in this chapter.) This property of an instance field is known as *lifetime*.

An instance field is visible to the entire class in which it's declared. In other words, the instance field can be accessed from anywhere in its class. Unless explicitly hidden (discussed later in this chapter), the instance field is visible to code outside of the class, but only in the context of an object reference variable. This property of an instance field is known as *scope*.

## Reviewing Field-Access Rules

The previous examples of field access may seem confusing because you can sometimes specify the field's name directly, whereas you need to prefix a field name with an object reference or a class name and the member access operator at other times. The following rules dispel this confusion by giving you guidance on how to access fields from the various contexts:

- Specify the name of a class field as is from anywhere within the same class as the class field declaration. Example: `counter`
- Specify the name of a class field's class, followed by the member access operator, followed by the name of the class field from outside the class. Example: `Car.counter`
- Specify the name of an instance field as is from any instance method, constructor, or instance initializer (discussed later) in the same class as the instance field declaration. Example: `numDoors`
- Specify an object reference, followed by the member access operator, followed by the name of the instance field from any class method or class initializer (discussed later) within the same class as the instance field declaration or from outside the class. Example: `Car car = new Car(); car.numDoors = 2;`

Although the final rule might seem to imply that you can access an instance field from a class context, this isn't the case. Instead, you're accessing the field from an object context.

The previous access rules aren't exhaustive because there are two more field-access scenarios to consider: declaring a parameter or local variable with the same name as an instance field or as a class field. In either scenario, the local variable/parameter is said to *shadow* (hide or mask) the field.

If you've declared a parameter/local variable that shadows a field, you can rename it, or you can use the member access operator with a class name (class field) or reserved word `this` (instance field) to identify the field explicitly. For example, Listing 3-15's `Car(String make, String model, int numDoors)` constructor demonstrated this latter solution by specifying statements such as `this.make = make;` to distinguish an instance field from a same-named parameter/local variable.

## Representing Behaviors via Methods

Java represents behaviors via *methods*, which are named blocks of code declared within a class's body. Behaviors associated with a class are described by *class methods*, whereas behaviors associated with objects are described by *object methods* (also known as *instance methods*).

**Note** By convention, a method's name begins with a lowercase letter, and the first letter of each subsequent word in a multiword method name is capitalized.

## Declaring and Invoking Class Methods

A *class method* stores a behavior that's associated with a class. All objects created from that class share this class method. The class method has no direct access to instance fields. The only way to access these fields is to access them in the context of a specific object, via an object reference variable and the member access operator.

A class method has the following syntax:

```
static return_type name(parameter_list)
{
    // statements to execute
}
```

A class method begins with a header that starts with `static`. This reserved word is followed by a return type that specifies the type of value that the method returns. The return type is either a primitive type name (such as `int` or `double`), a reference type name (such as `String`), or reserved word `void` when the class method doesn't return any kind of value.

The class method's name follows its return type. This name must be a legal Java identifier that isn't a reserved word.

**Note** A method's name and the number, types, and order of its parameters are known as its *signature*.

As with a constructor, the class method header concludes with a parameter list that lets you specify the kinds of data items that are passed to the method for processing.

The header is followed by a brace-delimited body of statements that execute when the class method is invoked.

You've already encountered the `public static void main(String[] args)` class method that serves as a class's entry point. The `java` tool creates an array of `String` objects, one object per command-line argument, and passes this array to the `args` parameter so that code within `main()` can process these arguments when it invokes `main()`.

For a second class method example, consider Listing 3-19's `Utilities` class and its `dumpMatrix()` class method.

*Listing 3-19. A Utilities Class with a Single Class Method for Dumping a Matrix in Tabular Format*

```

public class Utilities
{
    static void dumpMatrix(float[][] matrix)
    {
        for (int row = 0; row < matrix.length; row++)
        {
            for (int col = 0; col < matrix[row].length; col++)
                System.out.print(matrix[row][col] + " ");
            System.out.print("\n");
        }
    }

    public static void main(String[] args)
    {
        float[][] temperatures = {
            { 37.0f, 14.0f, -22.0f },
            { 0.0f, 29.0f, -5.0f }
        };

        dumpMatrix(temperatures);
        System.out.println();
        Utilities.dumpMatrix(temperatures);
    }
}

```

The `dumpMatrix()` class method dumps the contents of a two-dimensional array in tabular format to the standard output stream. The method's header tells us that the method doesn't return anything (its return type is `void`), the method is named `dumpMatrix`, and the method contains a parameter list consisting of a single parameter named `matrix`, which is of type `float[][]`.

Within the method, `row` and `col` are declared as local variables. The `row` variable is declared in the outer `for` loop. Its scope ranges from its `for` loop header through the end of the brace-delimited block that follows this header. The `col` variable is declared in the inner `for` loop. Its scope ranges from its `for` loop header through the end of the single-statement block (`System.out.print(matrix[row][col] + " ");`) that follows this header.

A third class method, `public static void main(String[] args)`, is present for testing purposes. After declaring a `temperatures` matrix, it shows you two ways to invoke `dumpMatrix()`. The invocation without a prefix is used when the class method being invoked is declared in the same class. A prefix is typically specified only when the class method is being called from a different class.

Compile Listing 3-19 as follows:

```
javac Utilities.java
```

Run the `Utilities` application as follows:

```
java Utilities
```

You should observe the following output:

---

```
37.0 14.0 -22.0
0.0 29.0 -5.0
```

```
37.0 14.0 -22.0
0.0 29.0 -5.0
```

---

## METHOD-CALL STACK

Method invocations require a *method-call stack* (also known as a *method-invocation stack*) to keep track of the statements to which execution must return. Think of the method-call stack as a simulation of a pile of clean trays in a cafeteria. You *pop* (remove) the clean tray from the top of the pile and the dishwasher will *push* (insert) the next clean tray onto the top of the pile.

When a method is invoked, the virtual machine pushes its arguments and the address of the first statement to execute following the invoked method onto the method-call stack. The virtual machine also allocates stack space for the method's local variables. When the method returns, the virtual machine removes local variable space, pops the address and arguments off of the stack, and transfers execution to the statement at this address.

---

## Declaring and Invoking Instance Methods

An *instance method* stores a behavior that's associated with an object. Unlike a class method, an instance method can directly access an object's instance fields.

An instance method has the following syntax:

```
return_type name(parameter_list)
{
    // statements to execute
}
```

Apart from the absence of the `static` reserved word, this syntax is the same as the syntax for a class method.

Listing 3-20 refactors Listing 3-15's `Car` class also to include a `printDetails()` instance method.

*Listing 3-20. Extending the `Car` class with an Instance Method that Prints Details*

```
class Car
{
    String make;
    String model;
    int numDoors;
```

```
Car(String make, String model)
{
    this(make, model, 4);
}

Car(String make, String model, int nDoors)
{
    this.make = make;
    this.model = model;
    numDoors = nDoors;
}

void printDetails()
{
    System.out.println("Make = " + make);
    System.out.println("Model = " + model);
    System.out.println("Number of doors = " + numDoors);
    System.out.println();
}
}
```

The `printDetails()` method has its return type set to `void` because it doesn't return a value. It prints out the car's make, model, and number of doors; and then outputs a blank line separator.

Listing 3-21 presents a `Cars` application that creates `Car` objects and invokes each object's `printDetails()` instance method.

*Listing 3-21. Demonstrating Instance Method Calls*

```
public class Cars
{
    public static void main(String[] args)
    {
        Car myCar = new Car("Toyota", "Camry");
        myCar.printDetails();
        Car yourCar = new Car("Mazda", "RX-8", 2);
        yourCar.printDetails();
    }
}
```

The `main()` method instantiates `Car`, passing appropriate make and model strings to its two-parameter constructor; the number of doors defaults to 4. It then invokes `printDetails()` on the returned object reference to print these values. Next, `main()` creates a second `Car` object via the three-parameter constructor and prints out this object's make, model, and number of doors.

`main()`'s invocation of `printDetails()` demonstrates that an instance method is always invoked in an object reference context.

Compile Listing 3-21 as follows:

```
javac Cars.java
```

Run the Cars application as follows:

```
java Cars
```

You should observe the following output:

---

```
Make = Toyota  
Model = Camry  
Number of doors = 4
```

```
Make = Mazda  
Model = RX-8  
Number of doors = 2
```

---

**Note** When an instance method is invoked, Java passes a hidden argument to the method (as the leftmost argument in a list of arguments). This argument is the reference to the object on which the method is invoked. It's represented at the source code level via reserved word `this`. You don't need to prefix an instance field name with "this." from within the method whenever you attempt to access an instance field name that isn't also the name of a parameter because the Java compiler ensures that the hidden argument is used to access the instance field.

## Returning from a Method via the Return Statement

Java provides the return statement to terminate method execution and return control to the method's *caller* (the code sequence that called the method). This statement has the following syntax:

```
return [ expression ] ;
```

You can specify `return` without an expression and will typically use this form of the return statement to return prematurely from a method—or from a constructor. In other words, you don't want to execute all of the statements in the method/constructor. Check out Listing 3-22.

### *Listing 3-22. Returning Prematurely from an Instance Method*

```
public class Employee  
{  
    String name;  
  
    Employee(String name)  
    {  
        setName(name);  
    }  
}
```

```
void setName(String name)
{
    if (name == null)
    {
        System.out.println("name cannot be null");
        return;
    }
    else
        this.name = name;
}

public static void main(String[] args)
{
    Employee john = new Employee(null);
}
}
```

Listing 3-22's `Employee(String name)` constructor invokes the `setName()` instance method to initialize the name instance field. Providing a separate method for this purpose is a good idea because it lets you initialize the instance field at construction time and also at a later time. (Perhaps the employee changes his or her name.)

`setName()` uses an `if` statement to detect an attempt to assign the null reference to the name field. When such an attempt is detected, it outputs the “name cannot be null” error message and returns prematurely from the method so that the null value cannot be assigned (and replace a previously assigned name).

Compile Listing 3-22 as follows:

```
javac Employee.java
```

Run the `Employee` application as follows:

```
java Employee
```

You should observe the following output:

---

```
name cannot be null
```

---

**Caution** When using the return statement, you might run into a situation where the compiler outputs an “unreachable code” error message. It does so when it detects code that will never be executed and occupies memory unnecessarily. One area where you might encounter this problem is the switch statement. For example, suppose you specify `case 2: printUsageInstructions(); return; break;` as part of this statement. The compiler reports an error when it detects the `break` statement following the return statement because the `break` statement is unreachable; it never can be executed.

The previous form of the return statement isn't legal in a method that returns a value. For such methods, Java lets the method return a value (whose type must be compatible with the method's return type). The following example demonstrates this version:

```
static double divide(double dividend, double divisor)
{
    if (divisor == 0.0)
    {
        System.out.println("cannot divide by zero");
        return 0.0;
    }
    return dividend / divisor;
}
```

`divide()` uses an if statement to detect an attempt to divide its first argument by 0.0 and outputs an error message when this attempt is detected. Furthermore, it returns 0.0 to signify this attempt. If there is no problem, the division is performed and the result is returned.

**Caution** You cannot use this form of the return statement in a constructor because constructors don't have return types.

## Chaining Together Instance Method Calls

Two or more instance method calls can be chained together via the member access operator, which results in more compact code. To accomplish instance method call chaining, you need to rearchitect your instance methods somewhat differently, which Listing 3-23 reveals.

*Listing 3-23. Implementing Instance Methods So That Calls to These Methods Can be Chained Together*

```
public class SavingsAccount
{
    int balance;

    SavingsAccount deposit(int amount)
    {
        balance += amount;
        return this;
    }

    SavingsAccount printBalance()
    {
        System.out.println(balance);
        return this;
    }
}
```



```
public static void main(String[] args)
{
    new SavingsAccount().deposit(1000).printBalance();
}
```

To achieve instance method call chaining, Listing 3-23 declares `SavingsAccount` as the return type for the `deposit()` and `printBalance()` methods. Also, each method specifies `return this;` (return current object's reference) as its last statement.

In the `main()` method, `new SavingsAccount().deposit(1000).printBalance();` performs the following tasks.

1. It creates a `SavingsAccount` object.
2. It uses the returned `SavingsAccount` reference to invoke `SavingsAccount`'s `deposit()` instance method, to add one thousand dollars to the savings account (I'm ignoring cents for convenience).
3. It uses `deposit()`'s returned `SavingsAccount` reference to invoke `SavingsAccount`'s `printBalance()` instance method to output the account balance.

Compile Listing 3-23 as follows:

```
javac SavingsAccount.java
```

Run the `SavingsAccount` application as follows:

```
java SavingsAccount
```

You should observe the following output:

---

```
1000
```

---

**Note** I'll have more to say about instance method call chaining when I discuss fluent interfaces in Chapter 16.

## Passing Arguments to Methods

A method call includes a list of (zero or more) arguments being passed to the method. Java passes arguments to methods via a style of argument passing called *pass-by-value*, which the following example demonstrates:

```
Employee emp = new Employee("John ");
int recommendedAnnualSalaryIncrease = 1000;
printReport(emp, recommendAnnualSalaryIncrease);
printReport(new Employee("Cuifen"), 1500);
```

Pass-by-value passes the value of a variable (the reference value stored in `emp` or the 1000 value stored in `recommendedAnnualSalaryIncrease`, for example) or the value of some other expression (such as `new Employee("Cuifen")` or `1500`) to the method.

Because of pass-by-value, you cannot assign a different `Employee` object's reference to `emp` from inside `printReport()` via the `printReport()` parameter for this argument. After all, you have only passed a copy of `emp`'s value to the method.

Many methods and constructors require you to pass a fixed number of arguments when they are called. However, Java also provides the ability to pass a variable number of arguments; such methods/constructors are often referred to as *varargs methods/constructors*. To declare a method or constructor that takes a variable number of arguments, specify three consecutive periods after the type name of the method's/constructor's rightmost parameter.

The following example presents a `sum()` method that accepts a variable number of arguments:

```
static double sum(double... values)
{
    int total = 0;
    for (int i = 0; i < values.length; i++)
        total += values[i];
    return total;
}
```

`sum()`'s implementation totals the number of arguments passed to this method, for example, `sum(10.0, 20.0)` or `sum(30.0, 40.0, 50.0)`. (Behind the scenes, these arguments are stored in a one-dimensional array, as evidenced by `values.length` and `values[i]`.) After these values have been totaled, this total is returned via the `return` statement.

## Invoking Methods Recursively

A method normally executes statements that may include calls to other methods, such as `printDetails()` invoking `System.out.println()`. However, it's occasionally convenient to have a method call itself. This scenario is known as *recursion*.

For example, suppose you need to write a method that returns a *factorial* (the product of all the positive integers up to and including a specific integer). For example,  $3!$  (the  $!$  is the mathematical symbol for factorial) equals  $3 \times 2 \times 1$  or 6.

Your first approach to writing this method might consist of the code presented in the following example:

```
static int factorial(int n)
{
    int product = 1;
    for (int i = 2; i <= n; i++)
        product *= i;
    return product;
}
```

Although this code accomplishes its task (via iteration), `factorial()` could also be written according to the following example's recursive style:

```
static int factorial(int n)
{
    if (n == 1)
        return 1; // base problem
    else
        return n * factorial(n - 1);
}
```

The recursive approach takes advantage of being able to express a problem in simpler terms of itself. According to this example, the simplest problem, which is also known as the *base problem*, is  $1! (1)$ .

When an argument greater than 1 is passed to `factorial()`, this method breaks the problem into a simpler problem by calling itself with the next smaller argument value. Eventually, the base problem will be reached.

For example, calling `factorial(4)` results in the following stack of expressions:

```
4 * factorial(3)
3 * factorial(2)
2 * factorial(1)
```

This last expression is at the top of the stack. When `factorial(1)` returns 1, these expressions are evaluated as the stack begins to unwind:

- `2 * factorial(1)` now becomes  $2*1 (2)$
- `3 * factorial(2)` now becomes  $3*2 (6)$
- `4 * factorial(3)` now becomes  $4*6 (24)$

Recursion provides an elegant way to express many problems. Additional examples include searching tree-based data structures for specific values and, in a hierarchical file system, finding and outputting the names of all files that contain specific text.

**Caution** Recursion consumes stack space, so make sure that your recursion eventually ends in a base problem; otherwise, you will run out of stack space and your application will be forced to terminate.

## Overloading Methods

Java lets you introduce methods with the same name but different parameter lists into the same class. This feature is known as *method overloading*. When the compiler encounters a method invocation expression, it compares the called method's arguments list with each overloaded method's parameter list as it looks for the correct method to invoke.

Two same-named methods are overloaded when their parameter lists differ in number or order of parameters. Alternatively, two same-named methods are overloaded when at least one parameter differs in type. Listing 3-24 presents an application that demonstrates these scenarios in an instance method context.

*Listing 3-24. Demonstrating Method Overloading*

```
public class MO
{
    int add(int a, int b)
    {
        System.out.println("add(int, int) called");
        return a + b;
    }

    int add(int a, int b, int c)
    {
        System.out.println("add(int, int, int) called");
        return a + b + c;
    }

    double add(double a, double b)
    {
        System.out.println("add(double, double) called");
        return a + b;
    }

    public static void main(String[] args)
    {
        MO mo = new MO();
        int result = mo.add(10, 20);
        System.out.println("Result = " + result);
        result = mo.add(10, 20, 30);
        System.out.println("Result = " + result);
        double result2 = mo.add(5.0, 8.0);
        System.out.println("Result2 = " + result2);
    }
}
```

After creating an MO object, main() invokes this object's int add(int a, int b) instance method to add the two integer arguments together and save the result, which is subsequently output. Next, main() invokes int add(int a, int b, int c) to add the three integer arguments together and outputs the result. Finally, main() invokes double add(double a, double b) to add the two double precision floating-point arguments together and outputs the result.

Compile Listing 3-24 as follows:

```
javac MO.java
```

Run the M0 application as follows:

```
java M0
```

You should observe the following output:

---

```
add(int, int) called
Result = 30
add(int, int, int) called
Result = 60
add(double, double) called
Result2 = 13.0
```

---

You cannot overload a method by changing only the return type. For example, `double sum(double... values)` and `int sum(double... values)` are not overloaded. These methods are not overloaded because the compiler doesn't have enough information to choose which method to call when it encounters `sum(1.0, 2.0)` in source code.

## Reviewing Method-Invocation Rules

The previous examples of method invocation may seem confusing because you can sometimes specify the method's name directly, whereas you need to prefix a method name with an object reference or a class name and the member access operator at other times. The following rules dispel this confusion by giving you guidance on how to invoke methods from the various contexts:

- Specify the name of a class method as is from anywhere within the same class as the class method. Example: `dumpMatrix(temperatures);`
- Specify the name of the class method's class, followed by the member access operator, followed by the name of the class method from outside the class. Example: `Utilities.dumpMatrix(temperatures);` (You can also invoke a class method via an object instance, but that is considered bad form because it hides from casual observation the fact that a class method is being invoked.)
- Specify the name of an instance method as is from any instance method, constructor, or instance initializer in the same class as the instance method. Example: `setName(name);`
- Specify an object reference, followed by the member access operator, followed by the name of the instance method from any class method or class initializer within the same class as the instance method or from outside the class. Example: `Car car = new Car("Toyota", "Camry"); car.printDetails();`

Although the latter rule might seem to imply that you can call an instance method from a class context, this isn't the case. Instead, you call the method from an object context.

Also, don't forget to make sure that the number of arguments passed to a method, along with the order in which these arguments are passed, and the types of these arguments agree with their parameter counterparts in the method being invoked.

**Note** Field access and method call rules are combined in expression `System.out.println()`; where the leftmost member access operator accesses the `out` class field (of type `java.io.PrintStream`) in the `java.lang.System` class, and where the rightmost member access operator calls this field's `println()` method. You'll learn about `PrintStream` in Chapter 11 and `System` in Chapter 7.

## Hiding Information

Every class *X* exposes an *interface*, which are the constructors, methods, and (possibly) fields that can be accessed from outside of *X*. For example, in Listing 3-9, class field `counter` can be accessed from outside of its containing `Car` class so `counter` is part of that class's interface. Also, in Listing 3-20, instance method `printDetails()` can be accessed from outside of its containing `Car` class so `printDetails()` is part of that class's interface.

An interface serves as a contract between a class and its *clients*, which are external classes that communicate with the class and/or its instances by accessing fields (typically `public static final` fields, or constants) and calling constructors and methods. The contract is such that the class promises to not change its interface, which would break dependent clients.

*X* also provides an *implementation* (the code within exposed methods along with optional helper methods and optional supporting fields that shouldn't be exposed) that codifies the interface. *Helper methods* are methods that assist exposed methods and shouldn't be exposed themselves.

When designing a class, your goal is to expose a useful interface while hiding details of that interface's implementation. For example, consider Listing 3-15's `Car` class. This class exposes `make`, `model`, and `numDoors` instance fields along with a pair of constructors. Many developers would regard these instance fields to belong to `Car`'s implementation and should be hidden. After all, they could be renamed, their types could be changed, or they could be removed in a future version of the class, which would break dependent client code.

**Note** In contrast to nonconstant fields, you often expose constant fields. For example, Listing 3-11's `Employee` class exposes a `RETIREMENT_AGE` constant class field. However, you would probably hide constant fields that are only relevant within the context of the class in which they are declared. You would do so to prevent them from cluttering up the class's interface and exposing clients to unnecessary details.

You hide the implementation to prevent developers from accidentally accessing parts of your class that don't belong to the class's interface so that you're free to change the implementation without breaking client code. Hiding the implementation is often referred to as *information hiding*. Furthermore, many developers consider implementation hiding to be part of encapsulation.

Java supports implementation hiding by providing four levels of access control, where three of these levels are indicated via a reserved word. You can use the following access control levels to control access to fields, methods, and constructors and two of these levels to control access to classes:

- *Public*: A field, method, or constructor that is declared `public` is accessible from anywhere. Classes can be declared `public` as well. I typically declare a class that contains the `public static void main(String[] args)` entry-point method `public`. Classes that are to be visible outside their packages (see Chapter 5) are also declared `public`. Public classes must be declared in files whose names match the class names.
- *Protected*: A field, method, or constructor that is declared `protected` is accessible from all classes in the same package as the member's class as well as subclasses of that class regardless of package.
- *Private*: A field, method, or constructor that is declared `private` cannot be accessed from outside the class in which it's declared.
- *Package-private*: In the absence of an access-control reserved word, a field, method, or constructor is only accessible to classes within the same package as the member's class. The same is true for non-public classes. The absence of `public`, `protected`, or `private` implies `package-private`.

You will often declare your class's instance fields to be `private` and provide special `public` instance methods for setting and getting their values. By convention, methods that set field values have names starting with `set` and are known as *setters*. Similarly, methods that get field values have names with `get` (or `is`, for Boolean fields) prefixes and are known as *getters*. Listing 3-25 demonstrates this pattern in the context of an `Employee` class declaration.

*Listing 3-25. Separation of Interface from Implementation*

```
public class Employee
{
    private String name;

    public Employee(String name)
    {
        setName(name);
    }

    public void setName(String empName)
    {
        name = empName; // Assign the empName argument to the name field.
    }

    public String getName()
    {
        return name;
    }
}
```

Listing 3-25 presents an interface consisting of the public `Employee` class, its public constructor, and its public setter/getter methods. This class and these members can be accessed from anywhere. The implementation consists of the private `name` field and constructor/method code, which is only accessible within the `Employee` class.

It might seem pointless to go to all this bother when you could simply omit `private` and access the `name` field directly. However, suppose you're told to introduce a new constructor that takes separate first and last name arguments and new methods that set/get the employee's first and last names into this class. Furthermore, suppose that it's been determined that the first and last names will be accessed more often than the entire name. Listing 3-26 reveals these changes.

*Listing 3-26. Revising Implementation Without Affecting Existing Interface*

```
public class Employee
{
    private String firstName;
    private String lastName;

    public Employee(String name)
    {
        setName(name);
    }

    public Employee(String firstName, String lastName)
    {
        setName(firstName + " " + lastName);
    }

    public void setName(String name)
    {
        // Assume that the first and last names are separated by a
        // single space character. indexOf() locates a character in a
        // string; substring() returns a portion of a string.
        setFirstName(name.substring(0, name.indexOf(' ')));
        setLastName(name.substring(name.indexOf(' ') + 1));
    }

    public String getName()
    {
        return getFirstName() + " " + getLastName();
    }

    public void setFirstName(String empFirstName)
    {
        firstName = empFirstName;
    }

    public String getFirstName()
    {
        return firstName;
    }
}
```



```

public void setLastName(String empLastName)
{
    lastName = empLastName;
}

public String getLastName()
{
    return lastName;
}
}

```

Listing 3-26 reveals that the name field has been removed in favor of new `firstName` and `lastName` fields, which were added to improve performance. Because `setFirstName()` and `setLastName()` will be called more frequently than `setName()`, and because `getFirstName()` and `getLastName()` will be called more frequently than `getName()`, it's more performant (in each case) to have the first two methods set/get `firstName`'s and `lastName`'s values rather than merging either value into/extracting this value from `name`'s value.

Listing 3-26 also reveals `setName()` calling `setFirstName()` and `setLastName()`, and `getName()` calling `getFirstName()` and `getLastName()`, rather than directly accessing the `firstName` and `lastName` fields. Although avoiding direct access to these fields isn't necessary in this example, imagine another implementation change that adds more code to `setFirstName()`, `setLastName()`, `getFirstName()`, and `getLastName()`; not calling these methods will result in the new code not executing.

Client code (code that instantiates and uses a class, such as `Employee`) will not break when `Employee`'s implementation changes from that shown in Listing 3-25 to that shown in Listing 3-26, because the original interface remains intact, although the interface has been extended. This lack of breakage results from hiding Listing 3-25's implementation, especially the `name` field.

**Note** `setName()` invokes the `String` class's `indexOf()` and `substring()` methods. You'll learn about these and other `String` methods in Chapter 7.

Java provides a little-known information hiding-related language feature that lets one object (or class method/initializer) access another object's private fields or invoke its private methods. Listing 3-27 provides a demonstration.

*Listing 3-27. One Object Accessing Another Object's private Field*

```

public class PrivateAccess
{
    private int x;

    PrivateAccess(int x)
    {
        this.x = x;
    }
}

```

```

boolean equalTo(PrivateAccess pa)
{
    return pa.x == x;
}

public static void main(String[] args)
{
    PrivateAccess pa1 = new PrivateAccess(10);
    PrivateAccess pa2 = new PrivateAccess(20);
    PrivateAccess pa3 = new PrivateAccess(10);
    System.out.println("pa1 equal to pa2: " + pa1.equalTo(pa2));
    System.out.println("pa2 equal to pa3: " + pa2.equalTo(pa3));
    System.out.println("pa1 equal to pa3: " + pa1.equalTo(pa3));
    System.out.println(pa2.x);
}
}

```

Listing 3-27's `PrivateAccess` class declares a private `int` field named `x`. It also declares an `equalTo()` method that takes a `PrivateAccess` argument. The idea is to compare the argument object with the current object to determine if they are equal.

The equality determination is made by using the `==` operator to compare the value of the argument object's `x` instance field with the value of the current object's `x` instance field, returning `Boolean true` when they are the same. What may seem baffling is that Java lets you specify `pa.x` to access the argument object's private instance field. Also, `main()` is able to access `x` directly, via the `pa2` object.

I previously presented Java's four access-control levels and the following statement about private access control: "A field, method, or constructor that is declared `private` cannot be accessed from beyond the class in which it's declared." When you carefully consider this statement and examine Listing 3-27, you'll realize that `x` isn't being accessed from beyond the `PrivateAccess` class in which it's declared. Therefore, the private access-control level isn't being violated.

The only code that can access this private instance field is code located within the `PrivateAccess` class. If you attempted to access `x` via a `PrivateAccess` object that was created in the context of another class, the compiler would report an error.

Being able to access `x` directly from within `PrivateAccess` is a performance enhancement; it's faster to access this implementation detail directly than to call a method that returns its value.

Compile `PrivateAccess.java` as follows:

```
javac PrivateAccess.java
```

Run the application as follows:

```
java PrivateAccess
```

You should observe the following output:

```
pa1 equal to pa2: false
pa2 equal to pa3: false
pa1 equal to pa3: true
20
```

**Tip** Get into the habit of developing useful interfaces while hiding implementations because it will save you a lot of trouble when maintaining your classes.

## Initializing Classes and Objects

Classes and objects need to be properly initialized before they are used. You've already learned that class fields are initialized to default zero values after a class loads and can be subsequently initialized by assigning values to them in their declarations via class field initializers, for example, `static int counter = 1;`. Similarly, instance fields are initialized to default values when an object's memory is allocated via `new` and can be subsequently initialized by assigning values to them in their declarations via instance field initializers, for example, `int numDoors = 4;`

Another aspect of initialization that's already been discussed is the constructor, which is used to initialize an object, typically by assigning values to various instance fields, but is also capable of executing arbitrary code such as code that opens a file and reads the file's contents.

Java provides two additional initialization features: class initializers and instance initializers. These features will be discussed in the following sections.

## Class Initializers

Constructors perform initialization tasks for objects. Their counterpart from a class initialization perspective is the class initializer.

A *class initializer* is a `static`-prefixed block that's introduced into a class body. It's used to initialize a loaded class via a sequence of statements. For example, I once used a class initializer to load a custom database driver class. Listing 3-28 shows the loading details.

*Listing 3-28. Loading a Database Driver via a Class Initializer*

```
class JDBCFilterDriver implements Driver
{
    static private Driver d;

    static
    {
        // Attempt to load JDBC-ODBC Bridge Driver and register that
        // driver.
```

```

    try
    {
        Class c = Class.forName("sun.jdbc.odbc.JdbcOdbcDriver");
        d = (Driver) c.newInstance();
        DriverManager.registerDriver(new JDBCFilterDriver());
    }
    catch (Exception e)
    {
        System.out.println(e);
    }
}
//...
}

```

Listing 3-28's `JDBCFilterDriver` class uses its class initializer to load and instantiate the class that describes Java's JDBC-ODBC Bridge Driver and to register a `JDBCFilterDriver` instance with Java's database driver. Although this listing's JDBC-oriented code is probably meaningless to you right now, the listing illustrates the usefulness of class initializers. (I discuss JDBC in Chapter 14.)

A class can declare a mix of class initializers and class field initializers, as demonstrated in Listing 3-29.

*Listing 3-29. Mixing Class Initializers with Class Field Initializers*

```

class C
{
    static
    {
        System.out.println("class initializer 1");
    }

    static int counter = 1;

    static
    {
        System.out.println("class initializer 2");
        System.out.println("counter = " + counter);
    }
}

```

Listing 3-29 declares a class named `C` that specifies two class initializers and one class field initializer. When the Java compiler compiles into a classfile a class that declares at least one class initializer or class field initializer, it creates a special `void <clinit>()` class method that stores the bytecode equivalent of all class initializers and class field initializers in the order they occur (from top to bottom).

**Note** `<clinit>` isn't a valid Java method name but is a valid name from the runtime perspective. The angle brackets were chosen as part of the name to prevent a name conflict with any `clinit()` methods that you might declare in the class.

For class C, `<clinit>()` would first contain the bytecode equivalent of `System.out.println("class initializer 1");`, it would next contain the bytecode equivalent of `static int counter = 1;`, and it would finally contain the bytecode equivalent of `System.out.println("class initializer 2");` `System.out.println("counter = " + counter);`.

When class C is loaded into memory, `<clinit>()` executes immediately and generates the following output:

---

```
class initializer 1
class initializer 2
counter = 1
```

---

## Instance Initializers

Not all classes can have constructors, as you'll discover in Chapter 5 when I present anonymous classes. For these classes, Java offers the instance initializer to handle instance initialization tasks.

An *instance initializer* is a block that's introduced into a class body as opposed to being introduced as the body of a method or a constructor. The instance initializer is used to initialize an object via a sequence of statements, as demonstrated in Listing 3-30.

*Listing 3-30. Initializing a Pair of Arrays via an Instance Initializer*

```
class Graphics
{
    double[] sines;
    double[] cosines;

    {
        sines = new double[360];
        cosines = new double[sines.length];
        for (int degree = 0; degree < sines.length; degree++)
        {
            sines[degree] = Math.sin(Math.toRadians(degree));
            cosines[degree] = Math.cos(Math.toRadians(degree));
        }
    }
}
```

Listing 3-30's `Graphics` class uses an instance initializer to create an object's `sines` and `cosines` arrays and to initialize these arrays' elements to the sines and cosines of angles ranging from 0 through 359 degrees. It does so because it's faster to read array elements than to repeatedly call `Math.sin()` and `Math.cos()` elsewhere; performance matters. (In Chapter 7 I introduce `Math.sin()` and `Math.cos()`.)

A class can declare a mix of instance initializers and instance field initializers, as shown in Listing 3-31.

*Listing 3-31. Mixing Instance Initializers with Instance Field Initializers*

```
class C
{
    {
        System.out.println("instance initializer 1");
    }

    int counter = 1;

    {
        System.out.println("instance initializer 2");
        System.out.println("counter = " + counter);
    }
}
```

Listing 3-31 declares a class named `C` that specifies two instance initializers and one instance field initializer. When the Java compiler compiles a class into a classfile, it creates a special `void <init>()` method representing the default noargument constructor when no constructor is explicitly declared; otherwise, it creates an `<init>()` method for each encountered constructor. Furthermore, it stores in each `<init>()` method the bytecode equivalent of all instance initializers and instance field initializers in the order in which they occur (from top to bottom), and before the constructor code.

**Note** `<init>` isn't a valid Java method name, but it is a valid name from the runtime perspective. The angle brackets were chosen as part of the name to prevent a name conflict with any `init()` methods that you might declare in the class.

For class `C`, `<init>()` would first contain the bytecode equivalent of `System.out.println("instance initializer 1");`, it would next contain the bytecode equivalent of `int counter = 1;`, and it would finally contain the bytecode equivalent of `System.out.println("instance initializer 2");` `System.out.println("counter = " + counter);`.

When `new C()` executes, `<init>()` executes immediately and generates the following output:

---

```
instance initializer 1
instance initializer 2
counter = 1
```

---

**Note** You should rarely need to use the instance initializer, which isn't commonly used in industry. Other developers would likely miss the instance initializer while scanning the source code and might find it confusing.

## Initialization Order

A class's body can contain a mixture of class field initializers, class initializers, instance field initializers, instance initializers, and constructors. (You should prefer constructors to instance field initializers, although I'm guilty of not doing so consistently, and restrict your use of instance initializers to anonymous classes, discussed in Chapter 5.) Furthermore, class fields and instance fields initialize to default values. Understanding the order in which all of this initialization occurs is necessary to preventing confusion, so check out Listing 3-32.

*Listing 3-32. A Complete Initialization Demo*

```
public class InitDemo
{
    static double double1;
    double double2;
    static int int1;
    int int2;
    static String string1;
    String string2;

    static
    {
        System.out.println("[class] double1 = " + double1);
        System.out.println("[class] int1 = " + int1);
        System.out.println("[class] string1 = " + string1);
        System.out.println();
    }

    {
        System.out.println("[instance] double2 = " + double2);
        System.out.println("[instance] int2 = " + int2);
        System.out.println("[instance] string2 = " + string2);
        System.out.println();
    }

    static
    {
        double1 = 1.0;
        int1 = 1000000000;
        string1 = "abc";
    }

    {
        double2 = 1.0;
        int2 = 1000000000;
        string2 = "abc";
    }
}
```

```

InitDemo()
{
    System.out.println("InitDemo() called");
    System.out.println();
}

static double double3 = 10.0;
double double4 = 10.0;

static
{
    System.out.println("[class] double3 = " + double3);
    System.out.println();
}

{
    System.out.println("[instance] double4 = " + double3);
    System.out.println();
}

public static void main(String[] args)
{
    System.out.println ("main() started");
    System.out.println();
    System.out.println("[class] double1 = " + double1);
    System.out.println("[class] double3 = " + double3);
    System.out.println("[class] int1 = " + int1);
    System.out.println("[class] string1 = " + string1);
    System.out.println();
    for (int i = 0; i < 2; i++)
    {
        System.out.println("About to create InitDemo object");
        System.out.println();
        InitDemo id = new InitDemo();
        System.out.println("id created");
        System.out.println();
        System.out.println("[instance] id.double2 = " + id.double2);
        System.out.println("[instance] id.double4 = " + id.double4);
        System.out.println("[instance] id.int2 = " + id.int2);
        System.out.println("[instance] id.string2 = " + id.string2);
        System.out.println();
    }
}
}

```

Listing 3-32's `InitDemo` class declares two class fields and two instance fields for the double precision floating-point primitive type, one class field and one instance field for the integer primitive type, and one class field and one instance field for the `String` reference type. It also introduces one explicitly initialized class field, one explicitly initialized instance field, three class initializers,



three instance initializers, and one constructor. If you compile and run this code, you'll observe the following output:

---

```
[class] double1 = 0.0
[class] int1 = 0
[class] string1 = null
```

```
[class] double3 = 10.0
```

```
main() started
```

```
[class] double1 = 1.0
[class] double3 = 10.0
[class] int1 = 1000000000
[class] string1 = abc
```

```
About to create InitDemo object
```

```
[instance] double2 = 0.0
[instance] int2 = 0
[instance] string2 = null
```

```
[instance] double4 = 10.0
```

```
InitDemo() called
```

```
id created
```

```
[instance] id.double2 = 1.0
[instance] id.double4 = 10.0
[instance] id.int2 = 1000000000
[instance] id.string2 = abc
```

```
About to create InitDemo object
```

```
[instance] double2 = 0.0
[instance] int2 = 0
[instance] string2 = null
```

```
[instance] double4 = 10.0
```

```
InitDemo() called
```

```
id created
```

```
[instance] id.double2 = 1.0
[instance] id.double4 = 10.0
[instance] id.int2 = 1000000000
[instance] id.string2 = abc
```

---

As you study this output in conjunction with the aforementioned discussion of class initializers and instance initializers, you'll discover some interesting facts about initialization:

- Class fields initialize to default or explicit values just after a class is loaded. Immediately after a class loads, all class fields are zeroed to default values. Code within the `<clinit>()` method performs explicit initialization.
- All class initialization occurs prior to the `<clinit>()` method returning.
- Instance fields initialize to default or explicit values during object creation. When `new` allocates memory for an object, it zeros all instance fields to default values. Code within an `<init>()` method performs explicit initialization.
- All instance initialization occurs prior to the `<init>()` method returning.

Additionally, because initialization occurs in a top-down manner, attempting to access the contents of a class field before that field is declared or attempting to access the contents of an instance field before that field is declared causes the compiler to report an *illegal forward reference*.

## Collecting Garbage

Objects are created via reserved word `new`, but how are they destroyed? Without some way to destroy objects, they will eventually fill up the heap's available space and the application will not be able to continue. Java doesn't provide the developer with the ability to remove them from memory. Instead, Java handles this task by providing a *garbage collector*, which is code that runs in the background and occasionally checks for unreferenced objects. When the garbage collector discovers an unreferenced object (or multiple objects that reference each other and where there are no other references to each other—only **A** references **B** and only **B** references **A**, for example), it removes the object from the heap, making more heap space available.

An *unreferenced object* is an object that cannot be accessed from anywhere within an application. For example, `new Employee("John", "Doe");` is an unreferenced object because the `Employee` reference returned by `new` is thrown away. In contrast, a *referenced object* is an object where the application stores at least one reference. For example, `Employee emp = new Employee("John", "Doe");` is a referenced object because variable `emp` contains a reference to the `Employee` object.

A referenced object becomes unreferenced when the application removes its last stored reference. For example, if `emp` is a local variable that contains the only reference to an `Employee` object, this object becomes unreferenced when the method in which `emp` is declared returns. An application can also remove a stored reference by assigning `null` to its reference variable. For example, `emp = null;` removes the reference to the `Employee` object that was previously stored in `emp`.

**Note** The garbage collector scans an application's *object graph*, which is a hierarchy of all of the objects currently stored in the heap. It starts with the current *root set of references*, which is a collection of local variables, parameters, class fields, and instance fields that currently exist and that contain (possibly null) references to objects. From this starting point, the garbage collector traces through *subordinate references* (references to objects stored in other objects, for example, a `Car` class's string-based `make` field contains a reference to a `String` object) identifying all objects that are currently referenced. Objects that aren't *reachable* via the root set of references are considered unreferenced and can be removed from the heap.

Java's garbage collector eliminates a form of memory leakage in C++ implementations that don't rely on a garbage collector. In these C++ implementations, the developer must destroy dynamically-created objects before they go out of scope. If they vanish before destruction, they remain in the heap. Eventually, the heap fills and the application halts.

Although this form of memory leakage isn't a problem in Java, a related form of leakage is problematic: continually creating objects and forgetting to remove even one reference to each object causes the heap to fill up and the application eventually to come to a halt. This form of memory leakage typically occurs in the context of *collections* (object-based data structures that store objects) and is a major problem for applications that run for lengthy periods of time; a web server is one example. For shorter-lived applications, you won't normally notice this form of memory leakage. Consider Listing 3-33.

*Listing 3-33. A Memory-Leaking Stack*

```
public class Stack
{
    private Object[] elements;
    private int top;

    public Stack(int size)
    {
        elements = new Object[size];
        top = -1; // indicate that stack is empty
    }

    public void push(Object o)
    {
        if (top + 1 == elements.length)
        {
            System.out.println("stack is full");
            return;
        }
        elements[++top] = o;
    }
}
```

```

public Object pop()
{
    if (top == -1)
    {
        System.out.println("stack is empty");
        return null;
    }
    Object element = elements[top--];
    // elements[top + 1] = null;
    return element;
}

public static void main(String[] args)
{
    Stack stack = new Stack(2);
    stack.push("A");
    stack.push("B");
    stack.push("C");
    System.out.println(stack.pop());
    System.out.println(stack.pop());
    System.out.println(stack.pop());
}
}

```

Listing 3-33 describes a collection known as a *stack*, a data structure that stores elements in last-in, first-out order. Stacks are useful for remembering things, such as the instruction to return to when a method stops executing and must return to its caller.

Stack provides a `push()` method for pushing arbitrary objects onto the *top* of the stack and a `pop()` method for popping objects off of the stack's top in the reverse order to which they were pushed.

After creating a Stack object that can store a maximum of two objects, `main()` invokes `push()` three times, to push three String objects onto the stack. Because the stack's internal array can store two objects only, `push()` outputs an error message when `main()` tries to push "C".

At this point, `main()` attempts to pop three Objects off of the stack, outputting each object to the standard output device. The first two `pop()` method calls succeed, but the final method call fails and outputs an error message because the stack is empty when it's called.

When you run this application, it generates the following output:

---

```

stack is full
B
A
stack is empty
null

```

---

There is a problem with the Stack class: it leaks memory. When you push an object onto the stack, its reference is stored in the internal `elements` array. When you pop an object off of the stack, the object's reference is obtained and `top` is decremented, but the reference remains in the array (until you invoke `push()`).

Imagine a scenario where the `Stack` object's reference is assigned to a class field, which means that the `Stack` object hangs around for the life of the application. Furthermore, suppose that you have pushed three 50-megabyte `Image` objects onto the stack and then subsequently popped them off of the stack. After using these objects, you assign `null` to their reference variables, thinking that they will be garbage collected the next time the garbage collector runs. However, this won't happen because the `Stack` object still maintains its references to these objects, and so 150 megabytes of heap space won't be available to the application, and maybe the application will run out of memory.

The solution to this problem is for `pop()` to explicitly assign `null` to the `elements` entry before returning the reference. Simply uncomment the `elements[top + 1] = null;` line in Listing 3-33 to make this happen.

You might think that you should always assign `null` to reference variables when their referenced objects are no longer required. However, doing so often doesn't improve performance or free up significant amounts of heap space and can lead to thrown instances of the `java.lang.NullPointerException` class when you're not careful. (I discuss `NullPointerException` in the context of Chapter 5's coverage of Java's exceptions-oriented language features). You typically nullify reference variables in classes that manage their own memory, such as the aforementioned `Stack` class.

**Note** To learn more about garbage collection in a Java 5 context, check out Oracle's "Memory Management in the Java HotSpot Virtual Machine" whitepaper at [www.oracle.com/technetwork/java/javase/tech/memorymanagement-whitepaper-1-150020.pdf](http://www.oracle.com/technetwork/java/javase/tech/memorymanagement-whitepaper-1-150020.pdf)

## Revisiting Arrays

In Chapter 2, I introduced you to *arrays*, which are regions of memory (specifically, the heap) that store values in equal-size and contiguous slots, known as *elements*. I also presented several examples, including the following:

```
char gradeLetters[] = { 'A', 'B', 'C', 'D', 'F' };
```

Here you have an array variable named `gradeLetters` that stores a reference to a five-element region of memory, which stores the characters A, B, C, D, and F in contiguous and equal-size (16-bit) memory locations.

**Note** I've placed the `[]` brackets after `gradeLetters`. Although this is legal, it's conventional to place these brackets after the type name, as in `char[] gradeLetters = { 'A', 'B', 'C', 'D', 'F' };`. I demonstrate both approaches in this section.

You access an element by specifying `gradeLetters[x]`, where `x` is an integer that identifies an array element and is known as an *index*; the first array element is always located at index 0. The following example shows you how to output and change the first element's value:

```
System.out.println(gradeLetters[0]); // Output the first grade letter.
gradeLetters[0] = 'a';                // Perhaps you prefer lowercase grade letters.
```

The { 'A', 'B', 'C', 'D', 'F' } array-creation syntax is an example of *syntactic sugar* (syntax that simplifies a language, making it “sweeter” to use). Behind the scenes, the array is created with the `new` operator and initializes to these values, as follows:

```
char gradeLetters[] = new char[] { 'A', 'B', 'C', 'D', 'F' };
```

First, a five-character region of memory is allocated. Next, the region’s five character elements are initialized to A, B, C, D, and F. Finally, a reference to these elements is stored in array variable `gradeLetters`.

**Caution** It’s an error to place an integer value between the square brackets following `char`. For example, the compiler reports an error when it encounters the 5 in `new char[5] { 'A', 'B', 'C', 'D', 'F' };`.

You can think of an array as a special kind of object, although it’s not an object in the same sense that a class instance is an object. This pseudo-object has a solitary and read-only `length` field that contains the array’s size (the number of elements). For example, `gradeLetters.length` returns the number of elements (5) in the `gradeLetters` array.

Although you can use either of the previous two approaches to create an array, you will often specify a third approach that doesn’t involve explicit element initialization and subsequently initialize the array. This approach is demonstrated by the following code:

```
char gradeLetters[] = new char[5];
```

You specify the number of elements as a positive integer between the square brackets. Operator `new` zeros the bits in each array element’s storage location, which you interpret at the source code level as literal value `false`, `'\u0000'`, `0`, `0L`, `0.0`, `0.0F`, or `null` (depending on element type).

You can then initialize the array, as follows:

```
gradeLetters[0] = 'A';
gradeLetters[1] = 'B';
gradeLetters[2] = 'C';
gradeLetters[3] = 'D';
gradeLetters[4] = 'F';
```

However, you will probably find it more convenient to use a loop for this task, as follows:

```
for (int i = 0; i < gradeLetters.length; i++)
    gradeLetters[i] = 'A' + i;
```

The previous examples focused on creating an array whose values share a common primitive type (character, represented by the `char` keyword). You can also create an array of object references. For example, you can create an array to store three `Image` object references, as follows:

```
Image[] imArray = { new Image("image0.png"), new Image("image1.png"), new Image("image2.png") };
```

Here you have an array variable named `imArray` that stores a reference to a three-element region of memory, where each element stores a reference to an `Image` object. The `Image` object is located elsewhere in memory.

You access an `Image` element by specifying `imArray[x]`. The following example assumes the existence of a `getLength()` method that returns the image's length (in bytes) and calls this method on the first `Image` object to return the first image's length, which is subsequently output:

```
System.out.println(imArray[0].getLength());
```

As with the previous `gradeLetters` example, you can combine the `new` operator with the syntactic sugar initializer, as follows:

```
Image[] imArray = new Image[] { new Image("image0.png"), new Image("image1.png"),
                               new Image("image2.png") };
```

Finally, you can use the third approach, which initializes each object reference to the null reference by setting all of the bits in each element to 0. This approach is demonstrated as follows:

```
Image[] imArray = new Image[3];
```

Because `new` initializes each element to the null reference, you must explicitly initialize this array, and you can conveniently do so as follows:

```
for (int i = 0; i < imArray.length; i++)
    imArray[i] = new Image("image" + i + ".png"); // image0.png, image1.png, and so on
```

The `"image" + i + ".png"` expression uses the string concatenation operator (+) to combine `image` with the string equivalent of the integer value stored in variable `i` with `.png`. The resulting string is passed to `Image`'s `Image(String filename)` constructor, and the resulting reference is stored in one of the array elements.

**Note** Use of the string concatenation operator in a loop context can result in a lot of unnecessary `String` object creation, depending on the length of the loop. I will discuss this topic in Chapter 7 when I introduce you to the `String` class.

The previous examples have focused on creating *one-dimensional arrays*. However, you can also create *multidimensional arrays* (that is, arrays with two or more dimensions). For example, consider a two-dimensional array of temperature values.

Although you can use any of the three approaches to create the temperatures array, the third approach is preferable when the values vary greatly. The following example creates this array as a three-row-by-two-column table of double precision floating-point temperature values:

```
double[][] temperatures = new double[3][2];
```

Notice the two sets of square brackets between `double` and `temperatures`. These two sets of brackets signify the array as two-dimensional (a table). Also notice the two sets of square brackets following `new` and `double`. Each set contains a positive integer value signifying the number of rows (3) or the number of columns (2) for each row.

**Note** When creating a multidimensional array, the number of square bracket pairs that are associated with the array variable and the number of square bracket pairs that follow `new` and the type name must be the same.

After creating the array, you can populate its elements with suitable values. The following example initializes each `temperatures` element, which is accessed as `temperatures[row][col]`, to a randomly generated temperature value via `Math.random()`, which I'll explain in Chapter 7:

```
for (int row = 0; row < temperatures.length; row++)
    for (int col = 0; col < temperatures[row].length; col++)
        temperatures[row][col] = Math.random() * 100;
```

The outer for loop selects each row from row 0 to the length of the array (which identifies the number of rows in the array). The inner for loop selects each column from 0 to the length of the current row array (which identifies the number of columns represented by that array). In essence, you're looking at a one-dimensional row array where each element references a one-dimensional column array.

You can subsequently output these values in a tabular format by using another for loop, as demonstrated by the following example where the code makes no attempt to align the temperature values in perfect columns:

```
for (int row = 0; row < temperatures.length; row++)
{
    for (int col = 0; col < temperatures[row].length; col++)
        System.out.print(temperatures[row][col] + " ");
    System.out.println();
}
```

Java provides an alternative for creating a multidimensional array in which you create each dimension separately. For example, to create the previous two-dimensional `temperatures` array via `new` in this manner, first create a one-dimensional row array (the outer array), and then create a one-dimensional column array (the inner array), like so:

```
// Create the row array.
double[][] temperatures = new double[3][]; // Note the extra empty pair of brackets.
// Create a column array for each row.
for (int row = 0; row < temperatures.length; row++)
    temperatures[row] = new double[2]; // 2 columns per row
```

When you specify a different number of columns for each row, the resulting array is known as a *ragged array* because the array isn't rectangular.

**Note** When creating the row array, you must specify an extra pair of empty brackets as part of the expression following `new`. (For a three-dimensional array—a one-dimensional array of tables, where this array's elements reference row arrays—you must specify two pairs of empty brackets as part of the expression following `new`.)



---

**EXERCISES**

The following exercises are designed to test your understanding of Chapter 3's content.

1. What is a class?
2. How do you declare a class?
3. True or false: You can declare multiple public classes in a source file.
4. What is an object?
5. How do you obtain an object?
6. What is a constructor?
7. True or false: Java creates a default noargument constructor when a class declares no constructors.
8. What is a parameter list and what is a parameter?
9. What is an argument list and what is an argument?
10. True or false: You invoke another constructor by specifying the name of the class followed by an argument list.
11. Define arity.
12. What is a local variable?
13. Define lifetime.
14. Define scope.
15. What is encapsulation?
16. Define field.
17. What is the difference between an instance field and a class field?
18. What is a blank final, and how does it differ from a true constant?
19. How do you prevent a field from being shadowed?
20. Define method.
21. What is the difference between an instance method and a class method?
22. Define recursion.
23. How do you overload a method?
24. What is a class initializer and an instance initializer?
25. Define garbage collector.
26. What is an object graph?
27. True or false: `String[] letters = new String[2] { "A", "B" };` is correct syntax.
28. What is a ragged array?
29. Merge Listings 3-6 and 3-7 into a complete Image application that demonstrates its constructors.

30. Create a `Conversions` class with `c2f()` and `f2c()` class methods that convert their double arguments to degrees Fahrenheit or degrees Celsius. Introduce a `main()` method into this class to test these methods.
31. Create a `Utilities` class that incorporates the previous `factorial()` methods (using iteration and recursion) along with the `sum()` method that used the variable arguments feature to sum a variable number of arguments. Modify the recursive `factorial()` method to also handle the case of  $0!$ , which equals 1. Introduce a `main()` method into this class that demonstrates these methods.
32. The `factorial()` method provides an example of *tail recursion*, a special case of recursion in which the method's last statement contains a recursive call, which is known as a *tail call*. Provide another example of tail recursion in which you create a GCD application whose `static int gcd(int a, int b)` class method returns the highest integer that divides evenly into both arguments. In other words, this method returns the *greatest common divisor* of the integer arguments passed to `a` and `b`.
33. Create a `Book` class with private `name`, `author`, and International Standard Book Number (ISBN) fields. Provide a suitable constructor and getter methods that return field values. Introduce a `main()` method into this class that creates an array of `Book` objects and iterates over this array outputting each book's name, author, and ISBN.

---

## Summary

A class is a container for housing an application, and it is also a template for manufacturing objects. You declare a class by minimally specifying reserved word `class` followed by a name that identifies the class (so that it can be referred to from elsewhere in the source code), followed by a body. The body starts with an open brace character `{` and ends with a close brace `}`. Sandwiched between these delimiters are various kinds of member declarations.

Objects are instances of classes. You create objects by using the `new` operator to allocate memory and a constructor to initialize the object. A constructor is a block of code that's declared in a class for constructing an object from that class by initializing it in some manner. The `new` operator returns a reference to the newly created and initialized object.

A constructor doesn't have a name. Instead, you must specify the name of the class that declares the constructor. This name is followed by a round bracket-delimited parameter list, which is a comma-separated list of zero or more parameter declarations. A parameter is a constructor or method variable that receives an expression value passed to the constructor or method when it's called. This expression value is known as an argument.

When a class doesn't declare a constructor, Java implicitly creates a constructor for that class. The created constructor is known as the default noargument constructor because no arguments appear between its `(` and `)` characters when the constructor is invoked. The default noargument constructor isn't created when at least one constructor is declared in the class.

Classes typically combine state with behaviors. State refers to attributes that are read and/or written when an application runs, and behaviors refer to sequences of code that read/write attributes and perform other tasks. Combining state with behaviors is known as encapsulation.

Java represents state via fields, which are variables declared within a class's body. State associated with a class is described by class fields, whereas state associated with objects is described by object fields (also known as instance fields).

Java represents behaviors via methods, which are named blocks of code declared within a class's body. Behaviors associated with a class are described by class methods, whereas behaviors associated with objects are described by object methods (also known as instance methods).

Every class exposes an interface, which are the constructors, methods, and (possibly) fields that can be accessed from outside of the class. An interface serves as a contract between a class and its clients, which are external classes that communicate with the class and/or its instances by accessing fields and calling constructors and methods. The contract is such that the class promises to not change its interface, which would break dependent clients.

The class also provides an implementation (the code within exposed methods along with optional helper methods and optional supporting fields that shouldn't be exposed) that codifies the interface. Helper methods assist exposed methods and shouldn't be exposed.

When designing a class, your goal is to expose a useful interface while hiding details of that interface's implementation. You hide the implementation to prevent developers from accidentally accessing parts of your class that don't belong to the class's interface so that you're free to change the implementation without breaking client code. Hiding the implementation is often referred to as information hiding. Furthermore, many developers consider implementation hiding to be part of encapsulation.

Java supports implementation hiding by providing four levels of access control, where three of these levels are indicated via a reserved word: `public`, `private`, and `protected`. You can use these access control levels to control access to fields, methods, and constructors and two of these levels to control access to classes.

Classes and objects need to be properly initialized before they're used. You've already learned that class fields are initialized to default zero values after a class loads and can be subsequently initialized by assigning values to them in their declarations via class field initializers. Similarly, instance fields are initialized to default values when an object's memory is allocated via `new` and can be subsequently initialized by assigning values to them in their declarations via instance field initializers or via constructors.

Java also supports class initializers and instance initializers for this task. A class initializer is a `static`-prefixed block that's introduced into a class body. It's used to initialize a loaded class via a sequence of statements. An instance initializer is a block that's introduced into a class body as opposed to being introduced as the body of a method or a constructor. The instance initializer is used to initialize an object via a sequence of statements.

Objects are created via reserved word `new`, but how are they destroyed? Without some way to destroy objects, they will eventually fill up the heap's available space and the application will not be able to continue. Java doesn't provide the developer with the ability to remove them from memory. Instead, Java handles this task by providing a garbage collector, which is code that runs in the background and occasionally checks for unreferenced objects.

You can think of an array as a special kind of object, although it's not an object in the same sense that a class instance is an object. This pseudo-object has a solitary and read-only `length` field that contains the array's size (the number of elements). In addition to using the syntactic sugar first presented in Chapter 2 for creating an array, you can also create an array using the `new` operator, with or without the syntactic sugar.

Chapter 4 continues to explore the Java language by examining its support for inheritance, polymorphism, and interfaces.

# Discovering Inheritance, Polymorphism, and Interfaces

An *object-based language* is a language that encapsulates state and behaviors in objects. Java’s support for encapsulation (discussed in Chapter 3) qualifies it as an object-based language. However, Java is also an *object-oriented language* because it supports inheritance and polymorphism (as well as encapsulation). (Object-oriented languages are a subset of object-based languages.) In this chapter, I will introduce you to Java’s language features that support inheritance and polymorphism. Also, I will introduce you to interfaces, Java’s ultimate abstract type mechanism.

## Building Class Hierarchies

We tend to categorize stuff by saying things like “cars are vehicles” or “savings accounts are bank accounts.” By making these statements, we really are saying (from a software development perspective) that cars inherit vehicular state (such as make and color) and behaviors (such as park and display mileage) and that savings accounts inherit bank account state (such as balance) and behaviors (such as deposit and withdraw). Car, vehicle, savings account, and bank account are examples of real-world entity categories, and *inheritance* is a hierarchical relationship between similar entity categories in which one category inherits state and behaviors from at least one other entity category. Inheriting from a single category is *single inheritance*, and inheriting from at least two categories is *multiple inheritance*.

Java supports single inheritance in a class context to facilitate code reuse—why reinvent the wheel? In this context, a class inherits state and behaviors from another class through class extension. Because classes are involved, Java refers to this kind of inheritance as *implementation inheritance*.

Java supports multiple inheritance and also supports single inheritance in an interface context in which a class inherits behavior templates from one or more interfaces through interface implementation or in which an interface inherits behavior templates from one or more interfaces

through interface extension. Because interfaces are involved, Java refers to this kind of inheritance as *interface inheritance*. (I discuss interfaces later in this chapter.)

**Note** You reuse code by carefully extending classes, implementing interfaces, and extending interfaces. You start with something that is close to what you want and then you extend it to meet your goal. You don't reuse code by simply copying and pasting it. Copying and pasting often results in redundant (i.e., non-reusable) and buggy code.

In the next section, I will introduce you to Java's support for implementation inheritance by first focusing on class extension. I will then introduce you to a special class that sits at the top of Java's class hierarchy. After introducing you to composition, which is an alternative to implementation inheritance for reusing code, I will show you how composition can be used to overcome problems with implementation inheritance.

## Extending Classes

Java provides the reserved word `extends` for specifying a hierarchical relationship between two classes. For example, suppose you have a `Vehicle` class and want to introduce a `Car` class as a kind of `Vehicle`. Listing 4-1 uses `extends` to cement this relationship.

*Listing 4-1. Relating Two Classes via extends*

```
class Vehicle
{
    // member declarations
}

class Car extends Vehicle
{
    // member declarations
}
```

Listing 4-1 codifies a relationship that is known as an “is-a” relationship: a car is a kind of vehicle. In this relationship, `Vehicle` is known as the *base class*, *parent class*, or *superclass*; and `Car` is known as the *derived class*, *child class*, or *subclass*.

**Note** When you don't want anyone to extend one of your classes (for security or another reason), you must declare that class `final`. For example, if you specified `final class Vehicle {}`, the compiler would report an error upon encountering `class Car extends Vehicle {}`.

As well as being capable of providing its own member declarations, Car is capable of inheriting member declarations from its Vehicle superclass. As Listing 4-2 shows, non-private inherited members become accessible to members of the Car class.

*Listing 4-2. Inheriting Members*

```
class Vehicle
{
    private String make;
    private String model;
    private int year;

    Vehicle(String make, String model, int year)
    {
        this.make = make;
        this.model = model;
        this.year = year;
    }

    String getMake()
    {
        return make;
    }

    String getModel()
    {
        return model;
    }

    int getYear()
    {
        return year;
    }
}

public class Car extends Vehicle
{
    private int numWheels;

    Car(String make, String model, int year, int numWheels)
    {
        super(make, model, year);
        this.numWheels = numWheels;
    }

    public static void main(String[] args)
    {
        Car car = new Car("Ford", "Fiesta", 2009, 4);
        System.out.println("Make = " + car.getMake());
        System.out.println("Model = " + car.getModel());
        System.out.println("Year = " + car.getYear());
        // Normally, you cannot access a private field via an object
```

```

// reference. However, numWheels is being accessed from
// within a method (main()) that is part of the Car class.
System.out.println("Number of wheels = " + car.numWheels);
}
}

```

Listing 4-2's `Vehicle` class declares private fields that store a vehicle's make, model, and year; a constructor that initializes these fields to passed arguments; and getter methods that retrieve these fields' values.

The `Car` subclass provides a private `numWheels` field, a constructor that initializes a `Car` object's `Vehicle` and `Car` layers, and a `main()` class method for testing this class.

`Car`'s constructor uses reserved word `super` to call `Vehicle`'s constructor with `Vehicle`-oriented arguments and then initializes `Car`'s `numWheels` instance field. The `super()` call is analogous to specifying `this()` to call another constructor in the same class, but invokes a superclass constructor instead.

**Caution** The `super()` call can only appear in a constructor. Furthermore, it must be the first code that is specified in the constructor. If `super()` is not specified, and if the superclass does not have a noargument constructor, the compiler will report an error because the subclass constructor must call a noargument superclass constructor when `super()` is not present.

`Car`'s `main()` method creates a `Car` object, initializing this object to a specific make, model, year, and number of wheels. Four `System.out.println()` method calls subsequently output this information.

The first three `System.out.println()` method calls retrieve their pieces of information by calling the `Car` instance's inherited `getMake()`, `getModel()`, and `getYear()` methods. The final `System.out.println()` method call accesses the instance's `numWheels` field directly. Although it is generally not a good idea to access an instance field directly (doing so violates information hiding), `Car`'s `main()` method, which provides this access, is present only to test this class and would not exist in a real application that uses this class.

Because `Car` is declared to be a public class, Listing 4-2 would be stored in a file named `Car.java`. Therefore, execute `javac Car.java` to compile this source code into `Vehicle.class` and `Car.class`. Then execute `java Car` to test the `Car` class. This execution results in the following output:

```

Make = Ford
Model = Fiesta
Year = 2009
Number of wheels = 4

```

**Note** A class whose instances cannot be modified is known as an *immutable class*. `Vehicle` is an example. If `Car`'s `main()` method, which can directly read or write `numWheels`, was not present, `Car` would also be an example of an immutable class. Also, a class cannot inherit constructors, nor can it inherit private fields and methods. For example, `Car` doesn't inherit `Vehicle`'s constructor, nor does it inherit `Vehicle`'s private make, model, and year fields.

A subclass can *override* (replace) an inherited method so that the subclass's version of the method is called instead. Listing 4-3 shows you that the overriding method must specify the same name, parameter list, and return type as the method being overridden.

*Listing 4-3. Overriding a Method*

```
class Vehicle
{
    private String make;
    private String model;
    private int year;

    Vehicle(String make, String model, int year)
    {
        this.make = make;
        this.model = model;
        this.year = year;
    }

    void describe()
    {
        System.out.println(year + " " + make + " " + model);
    }
}

public class Car extends Vehicle
{
    private int numWheels;

    Car(String make, String model, int year, int numWheels)
    {
        super(make, model, year);
    }

    void describe()
    {
        System.out.print("This car is a "); // Print without newline - see Chapter 1.
        super.describe();
    }

    public static void main(String[] args)
    {
        Car car = new Car("Ford", "Fiesta", 2009, 4);
        car.describe();
    }
}
```

Listing 4-3's Car class declares a describe() method that overrides Vehicle's describe() method to output a car-oriented description. After outputting an initial message, this method uses reserved word super to call Vehicle's describe() method via super.describe();.



**Note** Call a superclass method from the overriding subclass method by prefixing the method's name with reserved word `super` and the member access operator. If you don't do this, you end up recursively calling the subclass's overriding method. Use `super` and the member access operator to access non-private superclass fields from subclasses that mask these fields by declaring same-named fields.

If you were to compile Listing 4-3 (`javac Car.java`) and run the Car application (`java Car`), you would discover that Car's overriding `describe()` method executes instead of Vehicle's overridden `describe()` method and outputs `This car is a 2009 Ford Fiesta`.

**Note** When you don't want anyone to extend one of your methods (for security or another reason), you must declare that method `final`. For example, if you specified `final void describe()` for Vehicle's `describe()` method, the compiler would report an error upon encountering an attempt to override this method in the Car class. Also, you cannot make an overriding method less accessible than the method it overrides. For example, if Car's `describe()` method was declared as `private void describe()`, the compiler would report an error because `private` access is less accessible than the default package access. However, `describe()` could be made more accessible by declaring it `public`, as in `public void describe()`.

Suppose you happened to replace Listing 4-3's `describe()` method with the method shown here:

```
void describe(String owner)
{
    System.out.print("This car, which is owned by " + owner + ", is a ");
    super.describe();
}
```

The modified Car class now has two `describe()` methods, the preceding explicitly declared method and the method inherited from Vehicle. The `void describe(String owner)` method doesn't override Vehicle's `describe()` method. Instead, it overloads this method.

The Java compiler helps you detect an attempt to overload instead of override a method at compile time by letting you prefix a subclass's method header with the `@Override` annotation, as shown below. (I will discuss annotations in Chapter 6.)

```
@Override
void describe()
{
    System.out.print("This car is a ");
    super.describe();
}
```

Specifying `@Override` tells the compiler that the method overrides another method. If you overload the method instead, the compiler reports an error. Without this annotation, the compiler would not report an error because method overloading is a valid feature.

**Tip** Get into the habit of prefixing overriding methods with the `@Override` annotation. This habit will help you detect overloading mistakes much sooner.

In Chapter 3, I discussed the initialization order of classes and objects, where you learned that class members are always initialized first and in a top-down order (the same order applies to instance members). Implementation inheritance adds a couple more details:

- A superclass's class initializers always execute before a subclass's class initializers.
- A subclass's constructor always calls the superclass constructor to initialize an object's superclass layer and then initializes the subclass layer.

Java's support for implementation inheritance only permits you to extend a single class. You cannot extend multiple classes because doing so can lead to problems. For example, suppose Java supported multiple implementation inheritance, and you decided to model a flying horse (from Greek mythology) via the class structure shown in Listing 4-4.

*Listing 4-4. A Fictional Demonstration of Multiple Implementation Inheritance*

```
class Bird
{
    void describe()
    {
        // code that outputs a description of a bird's appearance and behaviors
    }
}

class Horse
{
    void describe()
    {
        // code that outputs a description of a horse's appearance and behaviors
    }
}

public class FlyingHorse extends Bird, Horse
{
    public static void main(String[] args)
    {
        FlyingHorse pegasus = new FlyingHorse();
        pegasus.describe();
    }
}
```

Listing 4-4's class structure reveals an ambiguity resulting from each of `Bird` and `Horse` declaring a `describe()` method. Which of these methods does `FlyingHorse` inherit? A related ambiguity arises from same-named fields, possibly of different types. Which field is inherited?

## The Ultimate Superclass

A class that doesn't explicitly extend another class implicitly extends Java's `Object` class (located in the `java.lang` package—I will discuss packages in the next chapter). For example, Listing 4-1's `Vehicle` class extends `Object`, whereas `Car` extends `Vehicle`.

`Object` is Java's ultimate superclass because it serves as the ancestor of every other class but doesn't itself extend any other class. `Object` provides a common set of methods that other classes inherit. Table 4-1 describes these methods.

**Table 4-1.** *Object's Methods*

Method	Description
<code>Object clone()</code>	Create and return a copy of the current object.
<code>boolean equals(Object obj)</code>	Determine if the current object is equal to the object identified by <code>obj</code> .
<code>void finalize()</code>	Finalize the current object.
<code>Class&lt;?&gt; getClass()</code>	Return the current object's <code>java.lang.Class</code> object.
<code>int hashCode()</code>	Return the current object's hash code.
<code>void notify()</code>	Wake up one of the threads that are waiting on the current object's monitor.
<code>void notifyAll()</code>	Wake up all threads that are waiting on the current object's monitor.
<code>String toString()</code>	Return a string representation of the current object.
<code>void wait()</code>	Cause the current thread to wait on the current object's monitor until it is woken up via <code>notify()</code> or <code>notifyAll()</code> .
<code>void wait(long timeout)</code>	Cause the current thread to wait on the current object's monitor until it is woken up via <code>notify()</code> or <code>notifyAll()</code> or until the specified timeout value (in milliseconds) has elapsed, whichever comes first.
<code>void wait(long timeout, int nanos)</code>	Cause the current thread to wait on the current object's monitor until it is woken up via <code>notify()</code> or <code>notifyAll()</code> or until the specified timeout value (in milliseconds) plus <code>nanos</code> value (in nanoseconds) has elapsed, whichever comes first.

I will discuss the `clone()`, `equals()`, `finalize()`, `hashCode()`, and `toString()` methods shortly, but will defer a discussion of `notify()`, `notifyAll()`, and the `wait()` methods until Chapter 7, and defer a discussion of the `getClass()` method until Chapter 8.

## Cloning

The `clone()` method *clones* (duplicates) an object without calling a constructor. It copies each primitive or reference field's value to its counterpart in the clone, a task known as *shallow copying* or *shallow cloning*. Listing 4-5 demonstrates this behavior.

*Listing 4-5. Shallowly Cloning an Employee Object*

```
public class Employee implements Cloneable
{
    String name;
    int age;

    Employee(String name, int age)
    {
        this.name = name;
        this.age = age;
    }

    public static void main(String[] args) throws CloneNotSupportedException
    {
        Employee e1 = new Employee("John Doe", 46);
        Employee e2 = (Employee) e1.clone();
        System.out.println(e1 == e2); // Output: false
        System.out.println(e1.name == e2.name); // Output: true
    }
}
```

Listing 4-5 declares an `Employee` class with `name` and `age` instance fields and a constructor for initializing these fields. The `main()` method uses this constructor to initialize a new `Employee` object's copies of these fields to John Doe and 46.

**Note** A class must implement the `java.lang.Cloneable` interface or its instances cannot be shallowly cloned via `Object`'s `clone()` method—this method performs a runtime check to see if the class implements `Cloneable`. (I will discuss interfaces later in this chapter.) If a class doesn't implement `Cloneable`, `clone()` throws `java.lang.CloneNotSupportedException`. (Because `CloneNotSupportedException` is a checked exception, it's necessary for Listing 4-5 to satisfy the compiler by appending `throws CloneNotSupportedException` to the `main()` method's header. I will discuss exceptions in the next chapter.) The `java.lang.String` class is an example of a class that doesn't implement `Cloneable`; hence, `String` objects cannot be shallowly cloned.

After assigning the `Employee` object's reference to local variable `e1`, `main()` calls the `clone()` method on this variable to duplicate the object and then assigns the resulting reference to variable `e2`. The `(Employee)` cast is needed because `clone()` returns `Object`.

To prove that the objects whose references were assigned to `e1` and `e2` are different, `main()` next compares these references via `==` and outputs the Boolean result, which happens to be false. To prove that the `Employee` object was shallowly cloned, `main()` next compares the references in both `Employee` objects' `name` fields via `==` and outputs the Boolean result, which happens to be true.

**Note** In Listing 4-5, I didn't override `Object`'s `clone()` method because the `e1.clone()` method call occurred in the class whose instances were to be cloned. To clone an `Employee` object from another class (such as `UseEmployee`), I would have to override `clone()`, as follows: `@Override public Object clone() throws CloneNotSupportedException { return super.clone(); }`.

Shallow cloning is not always desirable because the original object and its clone refer to the same object via their equivalent reference fields. For example, each of Listing 4-5's two `Employee` objects refers to the same `String` object via its `name` field.

Although not a problem for `String`, whose instances are immutable, changing a mutable object via the clone's reference field causes the original (noncloned) object to see the same change via its reference field. For example, suppose you add a reference field named `hireDate` to `Employee`. This field is of type `Date` with `year`, `month`, and `day` instance fields. Because `Date` is intended to be mutable, you can change the contents of these fields in the `Date` instance assigned to `hireDate`.

Now suppose you plan to change the clone's date, but want to preserve the original `Employee` object's date. You cannot do this with shallow cloning because the change is also visible to the original `Employee` object. To solve this problem, you must modify the cloning operation so that it assigns a new `Date` reference to the `Employee` clone's `hireDate` field. This task, which is known as *deep copying* or *deep cloning*, is demonstrated in Listing 4-6.

*Listing 4-6. Deeply Cloning an Employee Object*

```
class Date
{
    int year, month, day;

    Date(int year, int month, int day)
    {
        this.year = year;
        this.month = month;
        this.day = day;
    }
}

public class Employee implements Cloneable
{
    String name;
    int age;
    Date hireDate;
```

```
Employee(String name, int age, Date hireDate)
{
    this.name = name;
    this.age = age;
    this.hireDate = hireDate;
}

@Override
protected Object clone() throws CloneNotSupportedException
{
    Employee emp = (Employee) super.clone();
    if (hireDate != null) // no point cloning a null object (one that doesn't exist)
        emp.hireDate = new Date(hireDate.year, hireDate.month, hireDate.day);
    return emp;
}

public static void main(String[] args) throws CloneNotSupportedException
{
    Employee e1 = new Employee("John Doe", 46, new Date(2000, 1, 20));
    Employee e2 = (Employee) e1.clone();
    System.out.println(e1 == e2); // Output: false
    System.out.println(e1.name == e2.name); // Output: true
    System.out.println(e1.hireDate == e2.hireDate); // Output: false
    System.out.println(e2.hireDate.year + " " + e2.hireDate.month + " " +
        e2.hireDate.day); // Output: 2000 1 20
}
}
```

Listing 4-6 declares `Date` and `Employee` classes. The `Date` class declares `year`, `month`, and `day` fields and a constructor. (You can declare a comma-separated list of variables on one line provided that these variables all share the same type, which is `int` in this case.)

`Employee` overrides the `clone()` method to deeply clone the `hireDate` field. This method first calls `Object`'s `clone()` method to shallowly clone the current `Employee` object's instance fields and then stores the new object's reference in `emp`. Assuming that `hireDate` doesn't contain the null reference, it next assigns a new `Date` object's reference to `emp`'s `hireDate` field; this object's fields are initialized to the same values as those in the original `Employee` object's `hireDate` instance.

At this point, you have an `Employee` clone with shallowly cloned `name` and `age` fields and a deeply cloned `hireDate` field. The `clone()` method finishes by returning this `Employee` clone.

**Note** If you're not calling `Object`'s `clone()` method from an overriding `clone()` method (because you prefer to deeply clone reference fields and do your own shallow copying of nonreference fields), it isn't necessary for the class containing the overriding `clone()` method to implement `Cloneable`, but it should implement this interface for consistency. `String` doesn't override `clone()`, so `String` objects cannot be deeply cloned.

## Equality

The `==` and `!=` operators compare two primitive values (such as integers) for equality (`==`) or inequality (`!=`). These operators also compare two references to see whether they refer to the same object or not. This latter comparison is known as an *identity check*.

You cannot use `==` and `!=` to determine whether two objects are logically the same (or not). For example, two `Car` objects with the same field values are logically equivalent. However, `==` reports them as unequal because of their different references.

**Note** Because `==` and `!=` perform the fastest possible comparisons and because string comparisons need to be performed quickly (especially when sorting a huge number of strings), the `String` class contains special support that allows literal strings and string-valued constant expressions to be compared via `==` and `!=`. (I will discuss this support when I present `String` in Chapter 7.) The following statements demonstrate these comparisons:

```
System.out.println("abc" == "abc"); // Output: true
System.out.println("abc" == "a" + "bc"); // Output: true
System.out.println("abc" == "Abc"); // Output: false
System.out.println("abc" != "def"); // Output: true
System.out.println("abc" == new String("abc")); // Output: false
```

Recognizing the need to support logical equality in addition to reference equality, Java provides an `equals()` method in the `Object` class. Because this method defaults to comparing references, you need to override `equals()` to compare object contents.

Before overriding `equals()`, make sure that this is necessary. For example, Java's `java.lang.StringBuffer` class doesn't override `equals()`. Perhaps this class's designers didn't think it necessary to determine whether two `StringBuffer` objects are logically equivalent or not.

You cannot override `equals()` with arbitrary code. Doing so will probably prove disastrous to your applications. Instead, you need to adhere to the contract that is specified in the Java documentation for this method, which I present next.

The `equals()` method implements an equivalence relation on nonnull object references:

- *It is reflexive*: For any nonnull reference value `x`, `x.equals(x)` returns true.
- *It is symmetric*: For any nonnull reference values `x` and `y`, `x.equals(y)` returns true if and only if `y.equals(x)` returns true.

- *It is transitive:* For any nonnull reference values **x**, **y**, and **z**, if **x.equals(y)** returns true and **y.equals(z)** returns true, then **x.equals(z)** returns true.
- *It is consistent:* For any nonnull reference values **x** and **y**, multiple invocations of **x.equals(y)** consistently return true or consistently return false, provided no information used in **equals()** comparisons on the objects is modified.
- For any nonnull reference value **x**, **x.equals(null)** returns false.

Although this contract probably looks somewhat intimidating, it isn't that difficult to satisfy. For proof, take a look at the implementation of the **equals()** method in Listing 4-7's **Point** class.

*Listing 4-7. Logically Comparing Point Objects*

```
public class Point
{
    private int x, y;

    Point(int x, int y)
    {
        this.x = x;
        this.y = y;
    }

    int getX()
    {
        return x;
    }

    int getY()
    {
        return y;
    }

    @Override
    public boolean equals(Object o)
    {
        if (!(o instanceof Point))
            return false;
        Point p = (Point) o;
        return p.x == x && p.y == y;
    }

    public static void main(String[] args)
    {
        Point p1 = new Point(10, 20);
        Point p2 = new Point(20, 30);
        Point p3 = new Point(10, 20);
        // Test reflexivity
        System.out.println(p1.equals(p1)); // Output: true
        // Test symmetry
        System.out.println(p1.equals(p2)); // Output: false
        System.out.println(p2.equals(p1)); // Output: false
    }
}
```



```

    // Test transitivity
    System.out.println(p2.equals(p3)); // Output: false
    System.out.println(p1.equals(p3)); // Output: true
    // Test nullability
    System.out.println(p1.equals(null)); // Output: false
    // Extra test to further prove the instanceof operator's usefulness.
    System.out.println(p1.equals("abc")); // Output: false
}
}

```

Listing 4-7's overriding `equals()` method begins with an `if` statement that uses the `instanceof` operator to determine whether the argument passed to parameter `o` is an instance of the `Point` class. If not, the `if` statement executes `return false`;

The `o instanceof Point` expression satisfies the last portion of the contract: for any nonnull reference value `x`, `x.equals(null)` returns `false`. Because the null reference is not an instance of any class, passing this value to `equals()` causes the expression to evaluate to `false`.

The `o instanceof Point` expression also prevents a `java.lang.ClassCastException` instance from being thrown via expression `(Point) o` in the event that you pass an object other than a `Point` object to `equals()`. (I will discuss exceptions in the next chapter.)

Following the cast, the contract's reflexivity, symmetry, and transitivity requirements are met by only allowing `Points` to be compared with other `Points` via expression `p.x == x && p.y == y`.

The final contract requirement, consistency, is met by making sure that the `equals()` method is deterministic. In other words, this method doesn't rely on any field value that could change from method call to method call.

**Tip** You can optimize the performance of a time-consuming `equals()` method by first using `==` to determine if `o`'s reference identifies the current object. Simply specify `if (o == this) return true`; as the `equals()` method's first statement. This optimization isn't necessary in Listing 4-7's `equals()` method, which has satisfactory performance.

It's important to always override the `hashCode()` method when overriding `equals()`. I didn't do so in Listing 4-7 because I have yet to formally introduce `hashCode()`.

## Finalization

*Finalization* refers to cleanup via the `finalize()` method, which is known as a *finalizer*. The `finalize()` method's Java documentation states that `finalize()` is "called by the garbage collector on an object when garbage collection determines that there are no more references to the object. A subclass overrides the `finalize()` method to dispose of system resources or to perform other cleanup."

`Object`'s version of `finalize()` does nothing; you must override this method with any needed cleanup code. Because the virtual machine might never call `finalize()` before an application terminates, you should provide an explicit cleanup method and have `finalize()` call this method as a safety net in case the method isn't otherwise called.

**Caution** Never depend on `finalize()` for releasing limited resources such as file descriptors. For example, if an application object opens files, expecting that its `finalize()` method will close them, the application might find itself unable to open additional files when a tardy virtual machine is slow to call `finalize()`. What makes this problem worse is that `finalize()` might be called more frequently on another virtual machine, resulting in this too-many-open-files problem not revealing itself. The developer might falsely believe that the application behaves consistently across different virtual machines.

If you decide to override `finalize()`, your object's subclass layer must give its superclass layer an opportunity to perform finalization. You can accomplish this task by specifying `super.finalize()`; as the last statement in your method, which the following example demonstrates:

```
@Override
protected void finalize() throws Throwable
{
    try
    {
        // Perform subclass cleanup.
    }
    finally
    {
        super.finalize();
    }
}
```

The example's `finalize()` declaration appends `throws Throwable` to the method header because the cleanup code might throw an exception. If an exception is thrown, execution leaves the method and, in the absence of `try-finally`, `super.finalize()`; never executes. (I will discuss exceptions and `try-finally` in Chapter 5.)

To guard against this possibility, the subclass's cleanup code executes in a block that follows reserved word `try`. If an exception is thrown, Java's exception-handling logic executes the block following the `finally` reserved word, and `super.finalize()`; executes the superclass's `finalize()` method.

**Note** The `finalize()` method has often been used to perform *resurrection* (making an unreferenced object referenced) to implement *object pools* that recycle the same objects when these objects are expensive (time-wise) to create (database connection objects are an example).

Resurrection occurs when you assign `this` (a reference to the current object) to a class or instance field (or to another long-lived variable). For example, you might specify `r = this;` within `finalize()` to assign the unreferenced object identified as `this` to a class field named `r`.

Because of the possibility for resurrection, there is a severe performance penalty imposed on the garbage collection of an object that overrides `finalize()`.

A resurrected object's finalizer cannot be called again.

## Hash Codes

The `hashCode()` method returns a 32-bit integer that identifies the current object's *hash code*, a small value that results from applying a mathematical function to a potentially large amount of data. The calculation of this value is known as *hashing*.

You must override `hashCode()` when overriding `equals()` and in accordance with the following contract, which is specified in `hashCode()`'s Java documentation:

- Whenever it is invoked on the same object more than once during an execution of a Java application, the `hashCode()` method must consistently return the same integer, provided no information used in `equals(Object)` comparisons on the object is modified. This integer need not remain consistent from one execution of an application to another execution of the same application.
- If two objects are equal according to the `equals(Object)` method, then calling the `hashCode()` method on each of the two objects must produce the same integer result.
- It is not required that if two objects are unequal according to the `equals(Object)` method, then calling the `hashCode()` method on each of the two objects must produce distinct integer results. However, the programmer should be aware that producing distinct integer results for unequal objects might improve the performance of hash tables.

Fail to obey this contract and your class's instances will not work properly with Java's hash-based Collections Framework classes, such as `java.util.HashMap`. (I will discuss `HashMap` and other Collections Framework classes in Chapter 9.)

If you override `equals()` but not `hashCode()`, you most importantly violate the second item in the contract: the hash codes of equal objects must also be equal. This violation can lead to serious consequences, as demonstrated in the following example:

```
java.util.Map<Point, String> map = new java.util.HashMap<Point, String>();
map.put(p1, "first point");
System.out.println(map.get(p1)); // Output: first point
System.out.println(map.get(new Point(10, 20))); // Output: null
```

Assume that the example's statements are appended to Listing 4-7's `main()` method—the `java.util.` prefix and `<Point, String>` have to do with packages and generics, which I discuss in Chapters 5 and 6.

After `main()` creates its `Point` objects and calls its `System.out.println()` methods, it executes the example's statements, which perform the following tasks:

- The first statement instantiates `HashMap`, which is in the `java.util` package.
- The second statement calls `HashMap`'s `put()` method to store Listing 4-7's `p1` object key and the "first point" value in the hashmap.
- The third statement retrieves the value of the hashmap entry whose `Point` key is logically equal to `p1` via `HashMap`'s `get()` method.
- The fourth statement is equivalent to the third statement but returns the null reference instead of "first point."

Although objects `p1` and `Point(10, 20)` are logically equivalent, these objects have different hash codes, resulting in each object referring to a different entry in the hashmap. If an object is not stored (via `put()`) in that entry, `get()` returns null.

Correcting this problem requires that `hashCode()` be overridden to return the same integer value for logically equivalent objects. I will show you how to accomplish this task when I discuss `HashMap` in Chapter 9.

## String Representation

The `toString()` method returns a string-based representation of the current object. This representation defaults to the object's class name, followed by the `@` symbol, followed by a hexadecimal representation of the object's hash code.

For example, if you were to execute `System.out.println(p1)`; to output Listing 4-7's `p1` object, you would see a line of output similar to `Point@3e25a5`. (`System.out.println()` calls `p1`'s inherited `toString()` method behind the scenes.)

You should strive to override `toString()` so that it returns a concise but meaningful description of the object. For example, you might declare, in Listing 4-7's `Point` class, a `toString()` method that is similar to the following:

```
@Override
public String toString()
{
    return "(" + x + ", " + y + ")";
}
```

This time, executing `System.out.println(p1)`; results in more meaningful output, such as `(10, 20)`.

## Composition

Implementation inheritance and composition offer two different approaches to reusing code. As you have learned, implementation inheritance is concerned with extending a class with a new class, which is based upon an "is-a" relationship between them: a `Car` is a `Vehicle`, for example.

On the other hand, *composition* is concerned with composing classes out of other classes, which is based upon a "has-a" relationship between them. For example, a `Car` has an `Engine`, `Wheels`, and a `SteeringWheel`.

You have already seen examples of composition in this chapter. For example, Listing 4-2's `Car` class includes `String make` and `String model` fields. Listing 4-8's `Car` class provides another example of composition.

*Listing 4-8. A Car Class Whose Instances Are Composed of Other Objects*

```

class Car extends Vehicle
{
    private Engine engine; // bicycles don't have engines
    private Wheel[] wheels; // boats don't have wheels
    private SteeringWheel steeringWheel; // hang gliders don't have steering wheels
}

```

Listing 4-8 demonstrates that composition and implementation inheritance are not mutually exclusive. Although not shown, Car inherits various members from its Vehicle superclass, in addition to providing its own engine, wheels, and steeringWheel fields.

## The Trouble with Implementation Inheritance

Implementation inheritance is potentially dangerous, especially when the developer doesn't have complete control over the superclass or when the superclass isn't designed and documented with extension in mind.

The problem is that implementation inheritance breaks encapsulation. The subclass relies on implementation details in the superclass. If these details change in a new version of the superclass, the subclass might break, even when the subclass isn't touched.

For example, suppose you have purchased a library of Java classes, and one of these classes describes an appointment calendar. Although you don't have access to this class's source code, assume that Listing 4-9 describes part of its code.

*Listing 4-9. An Appointment Calendar Class*

```

public class ApptCalendar
{
    private final static int MAX_APPT = 1000;
    private Appt[] appts;
    private int size;

    public ApptCalendar()
    {
        appts = new Appt[MAX_APPT];
        size = 0; // redundant because field automatically initialized to 0
                // adds clarity, however
    }

    public void addAppt(Appt appt)
    {
        if (size == appts.length)
            return; // array is full
        appts[size++] = appt;
    }
}

```

```
public void addAppts(Appt[] appts)
{
    for (int i = 0; i < appts.length; i++)
        addAppt(appts[i]);
}
```

Listing 4-9's `ApptCalendar` class stores an array of appointments, with each appointment described by an `Appt` instance. For this discussion, the details of `Appt` are irrelevant. It could be as trivial as `class Appt {}`.

Suppose you want to log each appointment in a file. Because a logging capability isn't provided, you extend `ApptCalendar` with Listing 4-10's `LoggingApptCalendar` class, which adds logging behavior in overriding `addAppt()` and `addAppts()` methods.

*Listing 4-10. Extending the Appointment Calendar Class*

```
public class LoggingApptCalendar extends ApptCalendar
{
    // A constructor is not necessary because the Java compiler will add a
    // noargument constructor that calls the superclass's noargument
    // constructor by default.

    @Override
    public void addAppt(Appt appt)
    {
        Logger.log(appt.toString());
        super.addAppt(appt);
    }

    @Override
    public void addAppts(Appt[] appts)
    {
        for (int i = 0; i < appts.length; i++)
            Logger.log(appts[i].toString());
        super.addAppts(appts);
    }
}
```

Listing 4-10's `LoggingApptCalendar` class relies on a `Logger` class whose void `log(String msg)` class method logs a string to a file (the details are unimportant). Notice the use of `toString()` to convert an `Appt` object to a `String` object, which is then passed to `log()`.

Although this class looks okay, it doesn't work as you might expect. Suppose you instantiate this class and add a few `Appt` instances to this instance via `addAppts()`, as demonstrated in the following manner:

```
LoggingApptCalendar lapptc = new LoggingApptCalendar();
lapptc.addAppts(new Appt[] { new Appt(), new Appt(), new Appt() });
```

If you also add a `System.out.println(msg);` method call to `Logger's log(String msg)` method, to output this method's argument, you will discover that `log()` outputs a total of six messages; each of the expected three messages (one per `Appt` object) is duplicated.

When `LoggingApptCalendar's addAppts()` method is called, it first calls `Logger.log()` for each `Appt` instance in the `appts` array that is passed to `addAppts()`. This method then calls `ApptCalendar's addAppts()` method via `super.addAppts(appts);`.

`ApptCalendar's addAppts()` method calls `LoggingApptCalendar's` overriding `addAppt()` method for each `Appt` instance in its `appts` array argument. `addAppt()` executes `Logger.log(appt.toString());` to log its `appt` argument's string representation, and you end up with three additional logged messages.

If you didn't override the `addAppts()` method, this problem would go away. However, the subclass would be tied to an implementation detail: `ApptCalendar's addAppts()` method calls `addAppt()`.

It isn't a good idea to rely on an implementation detail when the detail isn't documented. (I previously stated that you don't have access to `ApptCalendar's` source code.) When a detail isn't documented, it can change in a new version of the class.

Because a base class change can break a subclass, this problem is known as the *fragile base class problem*. A related cause of fragility that also has to do with overriding methods occurs when new methods are added to a superclass in a subsequent release.

For example, suppose a new version of the library introduces a new `public void addAppt(Appt appt, boolean unique)` method into the `ApptCalendar` class. This method adds the `appt` instance to the calendar when `unique` is false; and, when `unique` is true, it adds the `appt` instance only if it has not previously been added.

Because this method has been added after the `LoggingApptCalendar` class was created, `LoggingApptCalendar` doesn't override the new `addAppt()` method with a call to `Logger.log()`. As a result, `Appt` instances passed to the new `addAppt()` method are not logged.

Here is another problem: you introduce a method into the subclass that is not also in the superclass. A new version of the superclass presents a new method that matches the subclass method signature and return type. Your subclass method now overrides the superclass method and probably doesn't fulfill the superclass method's contract.

There is a way to make these problems disappear. Instead of extending the superclass, create a private field in a new class, and have this field reference an instance of the superclass. This task demonstrates composition because you are forming a "has-a" relationship between the new class and the superclass.

Additionally, have each of the new class's instance methods call the corresponding superclass method via the superclass instance that was saved in the private field, and also return the called method's return value. This task is known as *forwarding*, and the new methods are known as *forwarding methods*.

Listing 4-11 presents an improved `LoggingApptCalendar` class that uses composition and forwarding to forever eliminate the fragile base class problem and the additional problem of unanticipated method overriding.

Listing 4-11. A Composed Logging Appointment Calendar Class

```

public class LoggingApptCalendar
{
    private ApptCalendar apptCal;

    public LoggingApptCalendar(ApptCalendar apptCal)
    {
        this.apptCal = apptCal;
    }

    public void addAppt(Appt appt)
    {
        Logger.log(appt.toString());
        apptCal.addAppt(appt);
    }

    public void addAppts(Appt[] appts)
    {
        for (int i = 0; i < appts.length; i++)
            Logger.log(appts[i].toString());
        apptCal.addAppts(appts);
    }
}

```

Listing 4-11's `LoggingApptCalendar` class doesn't depend upon implementation details of the `ApptCalendar` class. You can add new methods to `ApptCalendar` and they will not break `LoggingApptCalendar`.

**Note** `LoggingApptCalendar` is an example of a *wrapper class*, a class whose instances wrap other instances. Each `LoggingApptCalendar` instance wraps an `ApptCalendar` instance. `LoggingApptCalendar` is also an example of the *Decorator design pattern*, which is presented on page 175 of *Design Patterns: Elements of Reusable Object-Oriented Software* by Erich Gamma, Richard Helm, Ralph Johnson, and John Vlissides (Addison-Wesley, 1995; ISBN: 0201633612).

When should you extend a class and when should you use a wrapper class? Extend a class when an “is-a” relationship exists between the superclass and the subclass, and either you have control over the superclass or the superclass has been designed and documented for class extension. Otherwise, use a wrapper class.

What does “design and document for class extension” mean? “Design” means provide protected methods that hook into the class's inner workings (to support writing efficient subclasses) and ensure that constructors and the `clone()` method never call overridable methods. “Document” means clearly state the impact of overriding methods.



**Caution** Wrapper classes shouldn't be used in a *callback framework*, an object framework in which an object passes its own reference to another object (via `this`) so that the latter object can call the former object's methods at a later time. This "calling back to the former object's method" is known as a *callback*. Because the wrapped object doesn't know of its wrapper class, it passes only its reference (via `this`), and resulting callbacks don't involve the wrapper class's methods.

## Changing Form

Some real-world entities can change their forms. For example, water (on Earth as opposed to interstellar space) is normally a liquid, but it changes to a solid when frozen, and it changes to a gas when heated to its boiling point. Insects such as butterflies that undergo metamorphosis are another example.

The ability to change form is known as *polymorphism* and is useful to model in a programming language. For example, code that draws arbitrary shapes can be expressed more concisely by introducing a single `Shape` class and its `draw()` method and by invoking that method for each `Circle` instance, `Rectangle` instance, and other `Shape` instance stored in an array. When `Shape`'s `draw()` method is called for an array instance, it is the `Circle`'s, `Rectangle`'s or other `Shape` instance's `draw()` method that gets called. There are many forms of `Shape`'s `draw()` method. In other words, this method is polymorphic.

Java supports four kinds of polymorphism:

- *Coercion*: An operation serves multiple types through implicit type conversion. For example, division lets you divide an integer by another integer or divide a floating-point value by another floating-point value. If one operand is an integer and the other operand is a floating-point value, the compiler *coerces* (implicitly converts) the integer to a floating-point value to prevent a type error. (There is no division operation that supports an integer operand and a floating-point operand.) Passing a subclass object reference to a method's superclass parameter is another example of coercion polymorphism. The compiler coerces the subclass type to the superclass type to restrict operations to those of the superclass.
- *Overloading*: The same operator symbol or method name can be used in different contexts. For example, `+` can be used to perform integer addition, floating-point addition, or string concatenation, depending on the types of its operands. Also, multiple methods having the same name can appear in a class (through declaration and/or inheritance).
- *Parametric*: Within a class declaration, a field name can associate with different types and a method name can associate with different parameter and return types. The field and method can then take on different types in each class instance. For example, a field might be of type `java.lang.Integer` and a method might return an `Integer` in one class instance, and the same field might be of type `String` and the same method might return a `String` in another class instance. Java supports parametric polymorphism via generics, which I will discuss in Chapter 6.

- *Subtype*: A type can serve as another type's subtype. When a subtype instance appears in a supertype context, executing a supertype operation on the subtype instance results in the subtype's version of that operation executing. For example, suppose that `Circle` is a subclass of `Point` and that both classes contain a `draw()` method. Assigning a `Circle` instance to a variable of type `Point`, and then calling the `draw()` method via this variable, results in `Circle`'s `draw()` method being called.

Many developers don't regard coercion and overloading as valid kinds of polymorphism. They see coercion and overloading as nothing more than type conversions and syntactic sugar. In contrast, parametric and subtype are regarded as valid kinds of polymorphism.

In this section, I focus on subtype polymorphism by first examining upcasting and late binding. I then introduce you to abstract classes and abstract methods, downcasting and runtime type identification, and covariant return types.

## Upcasting and Late Binding

Listing 4-7's `Point` class represents a point as an x-y pair. Because a circle (in this example) is an x-y pair denoting its center, and has a radius denoting its extent, you can extend `Point` with a `Circle` class that introduces a radius field. Check out Listing 4-12.

*Listing 4-12. A Circle Class Extending the Point Class*

```
class Circle extends Point
{
    private int radius;

    Circle(int x, int y, int radius)
    {
        super(x, y);
        this.radius = radius;
    }

    int getRadius()
    {
        return radius;
    }

    @Override
    public String toString()
    {
        return "" + radius;
    }
}
```

Listing 4-12's `Circle` class describes a `Circle` as a `Point` with a radius, which implies that you can treat a `Circle` instance as if it was a `Point` instance. Accomplish this task by assigning the `Circle` instance to a `Point` variable, as demonstrated here:

```
Circle c = new Circle(10, 20, 30);
Point p = c;
```

The cast operator isn't needed to convert from `Circle` to `Point` because access to a `Circle` instance via `Point`'s interface is legal. After all, a `Circle` is at least a `Point`. This assignment is known as *upcasting* because you are implicitly casting up the type hierarchy (from the `Circle` subclass to the `Point` superclass).

After upcasting `Circle` to `Point`, you cannot call `Circle`'s `getRadius()` method because this method is not part of `Point`'s interface. Losing access to subtype features after narrowing a subclass to its superclass seems useless but is necessary for achieving subtype polymorphism.

In addition to upcasting the subclass instance to a variable of the superclass type, subtype polymorphism involves declaring a method in the superclass and overriding this method in the subclass. For example, suppose `Point` and `Circle` are to be part of a graphics application, and you need to introduce a `draw()` method into each class to draw a point and a circle, respectively. You end with the class structure shown in Listing 4-13.

*Listing 4-13. Declaring a Graphics Application's Point and Circle Classes*

```
class Point
{
    private int x, y;

    Point(int x, int y)
    {
        this.x = x;
        this.y = y;
    }

    int getX()
    {
        return x;
    }

    int getY()
    {
        return y;
    }

    @Override
    public String toString()
    {
        return "(" + x + ", " + y + ")";
    }

    void draw()
    {
        System.out.println("Point drawn at " + toString());
    }
}
```

```

    }
}

class Circle extends Point
{
    private int radius;

    Circle(int x, int y, int radius)
    {
        super(x, y);
        this.radius = radius;
    }

    int getRadius()
    {
        return radius;
    }

    @Override
    public String toString()
    {
        return "" + radius;
    }

    @Override
    void draw()
    {
        System.out.println("Circle drawn at " + super.toString() +
            " with radius " + toString());
    }
}

```

Listing 4-13's `draw()` methods will ultimately draw graphics shapes, but simulating their behaviors via `System.out.println()` method calls is sufficient during the early testing phase of the graphics application.

Now that you have temporarily finished with `Point` and `Circle`, you will want to test their `draw()` methods in a simulated version of the graphics application. To achieve this objective, you write Listing 4-14's `Graphics` class.

**Listing 4-14. A Graphics Class for Testing Point's and Circle's draw() Methods**

```

public class Graphics
{
    public static void main(String[] args)
    {
        Point[] points = new Point[] { new Point(10, 20), new Circle(10, 20, 30) };
        for (int i = 0; i < points.length; i++)
            points[i].draw();
    }
}

```

Listing 4-14's `main()` method first declares an array of `Points`. Upcasting is demonstrated by first having the array's initializer instantiate the `Circle` class and then by assigning this instance's reference to the second element in the `points` array.

Moving on, `main()` uses a for loop to call each `Point` element's `draw()` method. Because the first iteration calls `Point`'s `draw()` method, whereas the second iteration calls `Circle`'s `draw()` method, you observe the following output:

```
Point drawn at (10, 20)
Circle drawn at (10, 20) with radius 30
```

How does Java “know” that it must call `Circle`'s `draw()` method on the second loop iteration? Should it not call `Point`'s `draw()` method because `Circle` is being treated as a `Point` thanks to the upcast?

At compile time, the compiler doesn't know which method to call. All it can do is verify that a method exists in the superclass, and verify that the method call's arguments list and return type match the superclass's method declaration.

In lieu of knowing which method to call, the compiler inserts an instruction into the compiled code that, at runtime, fetches and uses whatever reference is in `points[i]` to call the correct `draw()` method. This task is known as *late binding*.

Late binding is used for calls to non-final instance methods. For all other method calls, the compiler knows which method to call and inserts an instruction into the compiled code that calls the method associated with the variable's type (not its value). This task is known as *early binding*.

You can also upcast from one array to another provided that the array being upcast is a subtype of the other array. Consider Listing 4-15.

*Listing 4-15. Demonstrating Array Upcasting*

```
class Point
{
    private int x, y;

    Point(int x, int y)
    {
        this.x = x;
        this.y = y;
    }

    int getX() { return x; }
    int getY() { return y; }
}

class ColoredPoint extends Point
{
    private int color;

    ColoredPoint(int x, int y, int color)
    {
```

```
        super(x, y);
        this.color = color;
    }

    int getColor() { return color; }
}

public class UpcastArrayDemo
{
    public static void main(String[] args)
    {
        ColoredPoint[] cptArray = new ColoredPoint[1];
        cptArray[0] = new ColoredPoint(10, 20, 5);
        Point[] ptArray = cptArray;
        System.out.println(ptArray[0].getX()); // Output: 10
        System.out.println(ptArray[0].getY()); // Output: 20
//      System.out.println(ptArray[0].getColor()); // Illegal
    }
}
```

Listing 4-15's `main()` method first creates a `ColoredPoint` array consisting of one element. It then instantiates this class and assigns the object's reference to this element. Because `ColoredPoint[]` is a subtype of `Point[]`, `main()` is able to upcast `cptArray`'s `ColoredPoint[]` type to `Point[]` and assign its reference to `ptArray`.

`main()` then invokes the `ColoredPoint` instance's `getX()` and `getY()` methods via `ptArray[0]`. It cannot invoke `getColor()` because `ptArray` has narrower scope than `cptArray`. In other words, `getColor()` is not part of `Point`'s interface.

## Abstract Classes and Abstract Methods

Suppose new requirements dictate that your graphics application must include a `Rectangle` class. Furthermore, this class must include a `draw()` method, and this method must be tested in a manner similar to that shown in Listing 4-14's `Graphics` application class.

In contrast to `Circle`, which is a `Point` with a radius, it doesn't make sense to think of a `Rectangle` as being a `Point` with a width and height. Rather, a `Rectangle` instance would probably be composed of a `Point` instance indicating its origin and a `Point` instance indicating its width and height extents.

Because circles, points, and rectangles are examples of shapes, it makes more sense to declare a `Shape` class with its own `draw()` method than to specify `class Rectangle extends Point`.

Listing 4-16 presents `Shape`'s declaration.

### *Listing 4-16. Declaring a Shape Class*

```
class Shape
{
    void draw()
    {
    }
}
```

Listing 4-16's Shape class declares an empty draw() method that only exists to be overridden and to demonstrate subtype polymorphism.

You can now refactor Listing 4-13's Point class to extend Listing 4-16's Shape class, leave Circle as is, and introduce a Rectangle class that extends Shape. You can then refactor Listing 4-14's Graphics class's main() method to take Shape into account. Listing 4-17 presents the resulting Graphics class.

*Listing 4-17. A Graphics Class with a New main() Method That Takes Shape into Account*

```
public class Graphics
{
    public static void main(String[] args)
    {
        Shape[] shapes = new Shape[] { new Point(10, 20), new Circle(10, 20, 30),
                                       new Rectangle(20, 30, 15, 25) };
        for (int i = 0; i < shapes.length; i++)
            shapes[i].draw();
    }
}
```

Because Point and Rectangle directly extend Shape, and because Circle indirectly extends Shape by extending Point, Listing 4-17's main() method will call the appropriate subclass's draw() method in response to shapes[i].draw();.

Although Shape makes the code more flexible, there is a problem. What is to stop the developer from instantiating Shape and adding this meaningless instance to the shapes array, as follows?

```
Shape[] shapes = new Shape[] { new Point(10, 20), new Circle(10, 20, 30),
                               new Rectangle(20, 30, 15, 25), new Shape() };
```

What does it mean to instantiate Shape? Because this class describes an abstract concept, what does it mean to draw a generic shape? Fortunately, Java provides a solution to this problem, which is demonstrated in Listing 4-18.

*Listing 4-18. Abstracting the Shape Class*

```
abstract class Shape
{
    abstract void draw(); // semicolon is required
}
```

Listing 4-18 uses Java's abstract reserved word to declare a class that cannot be instantiated. The compiler reports an error when you try to instantiate this class.

**Tip** Get into the habit of declaring classes that describe generic categories (such as shape, animal, vehicle, and account) abstract. This way, you will not inadvertently instantiate them.

The abstract reserved word is also used to declare a method without a body. The `draw()` method doesn't need a body because it cannot draw an abstract shape.

**Caution** The compiler reports an error when you attempt to declare a class that is both abstract and final. For example, `abstract final class Shape` is an error because an abstract class cannot be instantiated and a final class cannot be extended. The compiler also reports an error when you declare a method to be abstract but do not declare its class to be abstract. For example, removing `abstract` from the `Shape` class's header in Listing 4-18 results in an error. This removal is an error because a non-abstract (concrete) class cannot be instantiated when it contains an abstract method. Finally, when you extend an abstract class, the extending class must override all of the abstract class's abstract methods, or else the extending class must itself be declared to be abstract; otherwise, the compiler will report an error.

An abstract class can contain non-abstract methods in addition to or instead of abstract methods. For example, Listing 4-2's `Vehicle` class could have been declared `abstract`. The constructor would still be present, to initialize private fields, even though you could not instantiate the resulting class.

## Downcasting and Runtime Type Identification

Moving up the type hierarchy, via upcasting, causes loss of access to subtype features. For example, assigning a `Circle` instance to `Point` variable `p` means that you cannot use `p` to call `Circle`'s `getRadius()` method.

However, it is possible to once again access the `Circle` instance's `getRadius()` method by performing an explicit cast operation, for example, `Circle c = (Circle) p`; This assignment is known as *downcasting* because you are explicitly moving down the type hierarchy (from the `Point` superclass to the `Circle` subclass).

Although an upcast is always safe (the superclass's interface is a subset of the subclass's interface), the same cannot be said of a downcast. Listing 4-19 shows you what kind of trouble you can get into when downcasting is used incorrectly.

*Listing 4-19. The Trouble with Downcasting*

```
class A
{
}

class B extends A
{
    void m()
    {
    }
}

public class DowncastDemo
{
```



```

public static void main(String[] args)
{
    A a = new A();
    B b = (B) a;
    b.m();
}
}

```

Listing 4-19 presents a class hierarchy consisting of a superclass named A and a subclass named B. Although A doesn't declare any members, B declares a single `m()` method.

A third class named `DowncastDemo` provides a `main()` method that first instantiates A, and then tries to downcast this instance to B and assign the result to variable `b`. The compiler will not complain because downcasting from a superclass to a subclass in the same type hierarchy is legal.

However, if the assignment is allowed, the application will undoubtedly crash when it tries to execute `b.m()`; . The crash happens because the virtual machine will attempt to call a method that doesn't exist—class A doesn't have an `m()` method.

Fortunately, this scenario will never happen because the virtual machine verifies that the cast is legal before performing the cast operation. Because it detects that A doesn't have an `m()` method, it doesn't permit the cast by throwing an instance of the `ClassCastException` class.

The virtual machine's cast verification illustrates *runtime type identification* (or *RTTI*, for short). Cast verification performs RTTI by examining the type of the cast operator's operand to see whether the cast should be allowed or not. Clearly, the cast should not be allowed.

A second form of RTTI involves the `instanceof` operator. This operator checks the left operand to see whether or not it is an instance of the right operand and returns `true` if this is the case. The following example introduces `instanceof` to Listing 4-19 to prevent the `ClassCastException`:

```

if(a instanceof B)
{
    B b = (B) a;
    b.m();
}

```

The `instanceof` operator detects that variable `a`'s instance was not created from B and returns `false` to indicate this fact. As a result, the code that performs the illegal cast will not execute. (Overuse of `instanceof` probably indicates poor software design.)

Because a subtype is a kind of supertype, `instanceof` will return `true` when its left operand is a subtype instance or a supertype instance of its right operand supertype. The following example demonstrates this:

```

A a = new A();
B b = new B();
System.out.println(b instanceof A); // Output: true
System.out.println(a instanceof A); // Output: true

```

This example assumes the class structure shown in Listing 4-19 and instantiates superclass A and subclass B. The first `System.out.println()` method call outputs `true` because `b`'s reference identifies an instance of a subclass of A; the second `System.out.println()` method call outputs `true` because `a`'s reference identifies an instance of superclass A.

You can also downcast from one array to another provided that the array being downcast is a supertype of the other array, and its elements types are those of the subtype. Consider Listing 4-20.

*Listing 4-20. Demonstrating Array Downcasting*

```
class Point
{
    private int x, y;

    Point(int x, int y)
    {
        this.x = x;
        this.y = y;
    }

    int getX() { return x; }
    int getY() { return y; }
}

class ColoredPoint extends Point
{
    private int color;

    ColoredPoint(int x, int y, int color)
    {
        super(x, y);
        this.color = color;
    }

    int getColor() { return color; }
}

public class DowncastArrayDemo
{
    public static void main(String[] args)
    {
        ColoredPoint[] cptArray = new ColoredPoint[1];
        cptArray[0] = new ColoredPoint(10, 20, 5);
        Point[] ptArray = cptArray;
        System.out.println(ptArray[0].getX()); // Output: 10
        System.out.println(ptArray[0].getY()); // Output: 20
        // System.out.println(ptArray[0].getColor()); // Illegal
        if (ptArray instanceof ColoredPoint[])
        {
            ColoredPoint cp = (ColoredPoint) ptArray[0];
            System.out.println(cp.getColor());
        }
    }
}
```

Listing 4-20 is similar to Listing 4-15 except that it also demonstrates downcasting. Notice its use of `instanceof` to verify that `ptArray`'s referenced object is of type `ColoredPoint[]`. If this operator returns true, it is safe to downcast `ptArray[0]` from `Point` to `ColoredPoint` and assign the reference to `ColoredPoint`.

## Covariant Return Types

A *covariant return type* is a method return type that, in the superclass's method declaration, is the supertype of the return type in the subclass's overriding method declaration. Listing 4-21 provides a demonstration of this language feature.

*Listing 4-21. A Demonstration of Covariant Return Types*

```
class SuperReturnType
{
    @Override
    public String toString()
    {
        return "superclass return type";
    }
}

class SubReturnType extends SuperReturnType
{
    @Override
    public String toString()
    {
        return "subclass return type";
    }
}

class Superclass
{
    SuperReturnType createReturnType()
    {
        return new SuperReturnType();
    }
}

class Subclass extends Superclass
{
    @Override
    SubReturnType createReturnType()
    {
        return new SubReturnType();
    }
}

public class CovarDemo
{
```

```
public static void main(String[] args)
{
    SuperReturnType suprt = new Superclass().createReturnType();
    System.out.println(suprt); // Output: superclass return type
    SubReturnType subrt = new Subclass().createReturnType();
    System.out.println(subrt); // Output: subclass return type
}
}
```

Listing 4-21 declares `SuperReturnType` and `Superclass` superclasses and `SubReturnType` and `Subclass` subclasses; each of `Superclass` and `Subclass` declares a `createReturnType()` method. `Superclass`'s method has its return type set to `SuperReturnType`, whereas `Subclass`'s overriding method has its return type set to `SubReturnType`, a subclass of `SuperReturnType`.

Covariant return types minimize upcasting and downcasting. For example, `Subclass`'s `createReturnType()` method doesn't need to upcast its `SubReturnType` instance to its `SubReturnType` return type. Furthermore, this instance doesn't need to be downcast to `SubReturnType` when assigning to variable `subrt`.

In the absence of covariant return types, you would end up with Listing 4-22.

*Listing 4-22. Upcasting and Downcasting in the Absence of Covariant Return Types*

```
class SuperReturnType
{
    @Override
    public String toString()
    {
        return "superclass return type";
    }
}

class SubReturnType extends SuperReturnType
{
    @Override
    public String toString()
    {
        return "subclass return type";
    }
}

class Superclass
{
    SuperReturnType createReturnType()
    {
        return new SuperReturnType();
    }
}
```

```
class Subclass extends Superclass
{
    @Override
    SuperReturnType createReturnType()
    {
        return new SubReturnType();
    }
}

public class CovarDemo
{
    public static void main(String[] args)
    {
        SuperReturnType suprt = new Superclass().createReturnType();
        System.out.println(suprt); // Output: superclass return type
        SubReturnType subrt = (SubReturnType) new Subclass().createReturnType();
        System.out.println(subrt); // Output: subclass return type
    }
}
```

In Listing 4-22, the first bolded code reveals an upcast from `SubReturnType` to `SuperReturnType`, and the second bolded code uses the required (`SubReturnType`) cast operator to downcast from `SuperReturnType` to `SubReturnType`, prior to the assignment to `subrt`.

## Formalizing Class Interfaces

In my introduction to information hiding (see Chapter 3), I stated that every class *X* exposes an interface (a protocol consisting of constructors, methods, and [possibly] fields that are made available to objects created from other classes for use in creating and communicating with *X*'s objects).

Java formalizes the interface concept by providing reserved word `interface`, which is used to introduce a type without implementation. Java also provides language features to declare, implement, and extend interfaces. After looking at interface declaration, implementation, and extension in this section, I explain the rationale for using interfaces.

## Declaring Interfaces

An interface declaration consists of a header followed by a body. At minimum, the header consists of reserved word `interface` followed by a name that identifies the interface. The body starts with an open brace character and ends with a close brace. Sandwiched between these delimiters are constant and method header declarations. Consider Listing 4-23.

*Listing 4-23. Declaring a Drawable Interface*

```
interface Drawable
{
    int RED = 1; // For simplicity, integer constants are used. These constants are
    int GREEN = 2; // not that descriptive, as you will see.
    int BLUE = 3;
    int BLACK = 4;
    void draw(int color);
}
```

Listing 4-23 declares an interface named `Drawable`. By convention, an interface's name begins with an uppercase letter. Furthermore, the first letter of each subsequent word in a multiword interface name is capitalized.

**Note** Many interface names end with the `able` suffix. For example, the standard class library includes interfaces named `Callable`, `Comparable`, `Cloneable`, `Iterable`, `Runnable`, and `Serializable`. It is not mandatory to use this suffix; the standard class library also provides interfaces named `CharSequence`, `Collection`, `Executor`, `Future`, `Iterator`, `List`, `Map`, and `Set`.

`Drawable` declares four fields that identify color constants. `Drawable` also declares a `draw()` method that must be called with one of these constants to specify the color used to draw something.

**Note** You can precede `interface` with `public` to make your interface accessible to code outside of its package. (I will discuss packages in the next chapter). Otherwise, the interface is only accessible to other types in its package. You can also precede `interface` with `abstract`, to emphasize that an interface is abstract. Because an interface is already abstract, it is redundant to specify `abstract` in the interface's declaration. An interface's fields are implicitly declared `public`, `static`, and `final`. It is therefore redundant to declare them with these reserved words. Because these fields are constants, they must be explicitly initialized; otherwise, the compiler reports an error. Finally, an interface's methods are implicitly declared `public` and `abstract`. Therefore, it is redundant to declare them with these reserved words. Because these methods must be instance methods, don't declare them `static` or the compiler will report errors.

`Drawable` identifies a type that specifies what to do (draw something) but not how to do it. It leaves implementation details to classes that implement this interface. Instances of such classes are known as *drawables* because they know how to draw themselves.

**Note** An interface that declares no members is known as a *marker interface* or a *tagging interface*. It associates metadata with a class. For example, the presence of the `Cloneable` marker/tagging interface implies that instances of its implementing class can be shallowly cloned. RTTI is used to detect that an object's class implements a marker/tagging interface. For example, when `Object`'s `clone()` method detects, via RTTI, that the calling instance's class implements `Cloneable`, it shallowly clones the object.

## Implementing Interfaces

By itself, an interface is useless. To be of any benefit to an application, the interface needs to be implemented by a class. Java provides the `implements` reserved word for this task. This reserved word is demonstrated in Listing 4-24.

*Listing 4-24. Implementing the Drawable Interface*

```
class Point implements Drawable
{
    private int x, y;

    Point(int x, int y)
    {
        this.x = x;
        this.y = y;
    }

    int getX()
    {
        return x;
    }

    int getY()
    {
        return y;
    }

    @Override
    public String toString()
    {
        return "(" + x + ", " + y + ")";
    }

    @Override
    public void draw(int color)
    {
        System.out.println("Point drawn at " + toString() + " in color " + color);
    }
}
```

```
class Circle extends Point implements Drawable
{
    private int radius;

    Circle(int x, int y, int radius)
    {
        super(x, y);
        this.radius = radius;
    }

    int getRadius()
    {
        return radius;
    }

    @Override
    public String toString()
    {
        return "" + radius;
    }

    @Override
    public void draw(int color)
    {
        System.out.println("Circle drawn at " + super.toString() +
            " with radius " + toString() + " in color " + color);
    }
}
```

Listing 4-24 retrofits Listing 4-13's class hierarchy to take advantage of Listing 4-23's Drawable interface. You will notice that each of classes Point and Circle implements this interface by attaching the implements Drawable clause to its class header.

To implement an interface, the class must specify, for each interface method header, a method whose header has the same signature and return type as the interface's method header and a code body to go with the method header.

**Caution** When implementing a method, don't forget that the interface's methods are implicitly declared public. If you forget to include public in the implemented method's declaration, the compiler will report an error because you are attempting to assign weaker access to the implemented method.

When a class implements an interface, the class inherits the interface's constants and method headers and overrides the method headers by providing implementations (hence the @Override annotation). This is known as *interface inheritance*.



It turns out that `Circle`'s header doesn't need the `implements Drawable` clause. If this clause is not present, `Circle` inherits `Point`'s `draw()` method and is still considered to be a `Drawable`, whether it overrides this method or not.

An interface specifies a type whose data values are the objects whose classes implement the interface and whose behaviors are those specified by the interface. This fact implies that you can assign an object's reference to a variable of the interface type, provided that the object's class implements the interface. The following example provides a demonstration:

```
public static void main(String[] args)
{
    Drawable[] drawables = new Drawable[] { new Point(10, 20), new Circle(10, 20, 30) };
    for (int i = 0; i < drawables.length; i++)
        drawables[i].draw(Drawable.RED);
}
```

Because `Point` and `Circle` instances are drawables by virtue of these classes implementing the `Drawable` interface, it is legal to assign `Point` and `Circle` instance references to variables (including array elements) of type `Drawable`.

When you run this method, it generates the following output:

```
Point drawn at (10, 20) in color 1
Circle drawn at (10, 20) with radius 30 in color 1
```

Listing 4-23's `Drawable` interface is useful for drawing a shape's outline. Suppose you also need to fill a shape's interior. You might attempt to satisfy this requirement by declaring Listing 4-25's `Fillable` interface.

#### *Listing 4-25. Declaring a Fillable Interface*

```
interface Fillable
{
    int RED = 1;
    int GREEN = 2;
    int BLUE = 3;
    int BLACK = 4;
    void fill(int color);
}
```

Given Listings 4-23 and 4-25, you can declare that the `Point` and `Circle` classes implement both interfaces by specifying `class Point implements Drawable, Fillable` and `class Circle implements Drawable, Fillable`. You can then modify the `main()` method to also treat the drawables as *fillables* so that you can fill these shapes, as follows:

```
public static void main(String[] args)
{
    Drawable[] drawables = new Drawable[] { new Point(10, 20),
                                             new Circle(10, 20, 30) };
    for (int i = 0; i < drawables.length; i++)
        drawables[i].draw(Drawable.RED);
}
```

```

Fillable[] fillables = new Fillable[drawables.length];
for (int i = 0; i < drawables.length; i++)
{
    fillables[i] = (Fillable) drawables[i];
    fillables[i].fill(Fillable.GREEN);
}
}

```

After invoking each drawable's `draw()` method, `main()` creates a `Fillable` array of the same length as the `Drawable` array. It then proceeds to copy each `Drawable` array element to a `Fillable` array element and then invoke the fillable's `fill()` method. The `(Fillable)` cast is necessary because a `Drawable` is not a `Fillable`. This cast operation will succeed because the `Point` and `Circle` instances being copied implement `Fillable` as well as `Drawable`.

**Tip** You can list as many interfaces as you need to implement by specifying a comma-separated list of interface names after `implements`.

Implementing multiple interfaces can lead to name collisions, and the compiler will report errors. For example, suppose that you attempt to compile Listing 4-26's interface and class declarations.

*Listing 4-26. Colliding Interfaces*

```

interface A
{
    int X = 1;
    void foo();
}

interface B
{
    int X = 1;
    int foo();
}

class Collision implements A, B
{
    @Override
    public void foo();

    @Override
    public int foo() { return X; }
}

```

Each of Listing 4-26's A and B interfaces declares a constant named X. Despite each constant having the same type and value, the compiler will report an error when it encounters X in Collision's second `foo()` method because it doesn't know which X is being inherited.

Speaking of `foo()`, the compiler reports an error when it encounters Collision's second `foo()` declaration because `foo()` has already been declared. You cannot overload a method by changing only its return type.

The compiler will probably report additional errors. For example, the Java 7 compiler has this to say when told to compile Listing 4-26:

```
Collision.java:19: error: method foo() is already defined in class Collision
    public int foo() { return X; }
           ^
Collision.java:13: error: Collision is not abstract and does not override abstract method foo() in B
class Collision implements A, B
^
Collision.java:16: error: foo() in Collision cannot implement foo() in B
    public void foo();
           ^
    return type void is not compatible with int
Collision.java:19: error: reference to X is ambiguous, both variable X in A and variable X in B
match
    public int foo() { return X; }
                       ^
4 errors
```

## Extending Interfaces

Just as a subclass can extend a superclass via reserved word `extends`, you can use this reserved word to have a *subinterface* extend a *superinterface*. This, too, is known as *interface inheritance*.

For example, the duplicate color constants in `Drawable` and `Fillable` lead to name collisions when you specify their names by themselves in an implementing class. To avoid these name collisions, prefix a name with its interface name and the member access operator, or place these constants in their own interface, and have `Drawable` and `Fillable` extend this interface, as demonstrated in Listing 4-27.

*Listing 4-27. Extending the Colors Interface*

```
interface Colors
{
    int RED = 1;
    int GREEN = 2;
    int BLUE = 3;
    int BLACK = 4;
}

interface Drawable extends Colors
{
    void draw(int color);
}

interface Fillable extends Colors
```

```
{
    void fill(int color);
}
```

The fact that `Drawable` and `Fillable` both inherit constants from `Colors` is not a problem for the compiler. There is only a single copy of these constants (in `Colors`) and no possibility of a name collision, and so the compiler is satisfied.

If a class can implement multiple interfaces by declaring a comma-separated list of interface names after `implements`, it seems that an interface should be able to extend multiple interfaces in a similar way. This feature is demonstrated in Listing 4-28.

*Listing 4-28. Extending a Pair of Interfaces*

```
interface A
{
    int X = 1;
}

interface B
{
    double X = 2.0;
}

interface C extends A, B
{
}
```

Listing 4-28 will compile even though `C` inherits two same-named constants `X` with different types and initializers. However, if you implement `C` and then try to access `X`, as in Listing 4-29, you will run into a name collision.

*Listing 4-29. Discovering a Name Collision*

```
class Collision implements C
{
    public void output()
    {
        System.out.println(X); // Which X is accessed?
    }
}
```

Suppose you introduce a `void foo();` method header declaration into interface `A` and an `int foo();` method header declaration into interface `B`. This time, the compiler will report an error when you attempt to compile the modified Listing 4-28.

## Why Use Interfaces?

Now that the mechanics of declaring, implementing, and extending interfaces are out of the way, you can focus on the rationale for using them. Unfortunately, newcomers to Java's interfaces feature are often told that this feature was created as a workaround to Java's lack of support for multiple

implementation inheritance. While interfaces are useful in this capacity, this is not their reason for existence. Instead, ***Java's interfaces feature was created to give developers the utmost flexibility in designing their applications by decoupling interface from implementation. You should always code to the interface (supplied by an interface type or an abstract class).***

Those who are adherents to *agile software development* (a group of software development methodologies based on iterative development that emphasizes keeping code simple, testing frequently, and delivering functional pieces of the application as soon as they are deliverable), know the importance of flexible coding. They cannot afford to tie their code to a specific implementation because a change in requirements for the next iteration could result in a new implementation, and they might find themselves rewriting significant amounts of code, which wastes time and slows development.

Interfaces help you achieve flexibility by decoupling interface from implementation. For example, the `main()` method in Listing 4-17's `Graphics` class creates an array of objects from classes that subclass the `Shape` class, and then iterates over these objects, calling each object's `draw()` method. The only objects that can be drawn are those that subclass `Shape`.

Suppose you also have a hierarchy of classes that model resistors, transistors, and other electronic components. Each component has its own symbol that allows the component to be shown in a schematic diagram of an electronic circuit. Perhaps you want to add a drawing capability to each class that draws that component's symbol.

You might consider specifying `Shape` as the superclass of the electronic component class hierarchy. However, electronic components are not shapes (although they have shapes) so it makes no sense to place these classes in a class hierarchy rooted in `Shape`.

However, you can make each component class implement the `Drawable` interface, which lets you add expressions that instantiate these classes to the `drawables` array in the `main()` method appearing prior to Listing 4-25 (so you can draw their symbols). This is legal because these instances are `drawables`.

Wherever possible, you should strive to specify interfaces instead of classes in your code to keep your code adaptable to change. This is especially true when working with Java's Collections Framework, which I will discuss at length in Chapter 9.

**Tip** Always strive to specify interfaces instead of classes to keep your code adaptable to change.

For now, consider a simple example that consists of the Collections Framework's `java.util.List` interface and its `java.util.ArrayList` and `java.util.LinkedList` implementation classes. The following example presents inflexible code based on the `ArrayList` class:

```
ArrayList<String> arrayList = new ArrayList<String>();
void dump(ArrayList<String> arrayList)
{
    // suitable code to dump out the arrayList
}
```

This example uses the generics-based parameterized type language feature (which I will discuss in Chapter 6) to identify the kind of objects stored in an `ArrayList` instance. In this example, `String` objects are stored.

The example is inflexible because it hardwires the `ArrayList` class into multiple locations. This hardwiring focuses the developer into thinking specifically about array lists instead of generically about lists.

Lack of focus is problematic when a requirements change, or perhaps a performance issue brought about by *profiling* (analyzing a running application to check its performance), suggests that the developer should have used `LinkedList`.

The example only requires a minimal number of changes to satisfy the new requirement. In contrast, a larger code base might need many more changes. Although you only need to change `ArrayList` to `LinkedList`, to satisfy the compiler, consider changing `arrayList` to `linkedList` to keep *semantics* (meaning) clear—you might have to change multiple occurrences of names that refer to an `ArrayList` instance throughout the source code.

The developer is bound to lose time while refactoring the code to adapt to `LinkedList`. Instead, time could have been saved by writing this example to use the equivalent of constants. In other words, the example could have been written to rely on interfaces and to only specify `ArrayList` in one place. The following example shows you what the resulting code would look like:

```
List<String> list = new ArrayList<String>();
void dump(List<String> list)
{
    // suitable code to dump out the list
}
```

This example is much more flexible than the previous example. If a requirements or profiling change suggests that `LinkedList` should be used instead of `ArrayList`, simply replace `Array` with `Linked` and you are done. You don't even have to change the parameter name.

**Note** Java provides interfaces and abstract classes for describing *abstract types* (types that cannot be instantiated). Abstract types represent abstract concepts (`Drawable` and `Shape`, for example), and instances of such types would be meaningless.

Interfaces promote flexibility through lack of implementation—`Drawable` and `List` illustrate this flexibility. They are not tied to any single class hierarchy but can be implemented by any class in any hierarchy. In contrast, abstract classes support implementation but can be genuinely abstract (Listing 4-18's abstract `Shape` class, for example). However, they are limited to appearing in the upper levels of class hierarchies.

Interfaces and abstract classes can be used together. For example, the Collections Framework's `java.util` package provides `List`, `Map`, and `Set` interfaces and `AbstractList`, `AbstractMap`, and `AbstractSet` abstract classes that provide skeletal implementations of these interfaces.

By implementing many interface methods, the skeletal implementations make it easy for you to create your own interface implementations, to address your unique requirements. If they don't meet your needs, you can optionally have your class directly implement the appropriate interface.

**EXERCISES**

The following exercises are designed to test your understanding of Chapter 4's content:

1. What is implementation inheritance?
2. How does Java support implementation inheritance?
3. Can a subclass have two or more superclasses?
4. How do you prevent a class from being subclassed?
5. True or false: The `super()` call can appear in any method.
6. If a superclass declares a constructor with one or more parameters, and if a subclass constructor doesn't use `super()` to call that constructor, why does the compiler report an error?
7. What is an immutable class?
8. True or false: A class can inherit constructors.
9. What does it mean to override a method?
10. What is required to call a superclass method from its overriding subclass method?
11. How do you prevent a method from being overridden?
12. Why can you not make an overriding subclass method less accessible than the superclass method it is overriding?
13. How do you tell the compiler that a method overrides another method?
14. Why does Java not support multiple implementation inheritance?
15. What is the name of Java's ultimate superclass?
16. What is the purpose of the `clone()` method?
17. When does `Object`'s `clone()` method throw `CloneNotSupportedException`?
18. Explain the difference between shallow copying and deep copying.
19. Can the `==` operator be used to determine if two objects are logically equivalent? Why or why not?
20. What does `Object`'s `equals()` method accomplish?
21. Does expression `"abc" == "a" + "bc"` return true or false?
22. How can you optimize a time-consuming `equals()` method?
23. What is the purpose of the `finalize()` method?
24. Should you rely on `finalize()` for closing open files? Why or why not?
25. What is a hash code?
26. True or false: You should override the `hashCode()` method whenever you override the `equals()` method.
27. What does `Object`'s `toString()` method return?

28. Why should you override `toString()`?
29. Define composition.
30. True or false: Composition is used to describe “is-a” relationships and implementation inheritance is used to describe “has-a” relationships.
31. Identify the fundamental problem of implementation inheritance. How do you fix this problem?
32. Define subtype polymorphism.
33. How is subtype polymorphism accomplished?
34. Why would you use abstract classes and abstract methods?
35. Can an abstract class contain concrete methods?
36. What is the purpose of downcasting?
37. List two forms of RTTI.
38. What is a covariant return type?
39. How do you formally declare an interface?
40. True or false: You can precede an interface declaration with the `abstract` reserved word.
41. Define marker interface.
42. What is interface inheritance?
43. How do you implement an interface?
44. What problem might you encounter when you implement multiple interfaces?
45. How do you form a hierarchy of interfaces?
46. Why is Java’s interfaces feature so important?
47. What do interfaces and abstract classes accomplish?
48. How do interfaces and abstract classes differ?
49. Model part of an animal hierarchy by declaring `Animal`, `Bird`, `Fish`, `AmericanRobin`, `DomesticCanary`, `RainbowTrout`, and `SockeyeSalmon` classes:
  - `Animal` is public and abstract, declares private `String`-based `kind` and `appearance` fields, declares a public constructor that initializes these fields to passed-in arguments, declares public and abstract `eat()` and `move()` methods that take no arguments and whose return type is `void`, and overrides the `toString()` method to output the contents of `kind` and `appearance`.
  - `Bird` is public and abstract, extends `Animal`, declares a public constructor that passes its `kind` and `appearance` parameter values to its superclass constructor, overrides its `eat()` method to output `eats seeds and insects` (via `System.out.println()`), and overrides its `move()` method to output `flies through the air`.
  - `Fish` is public and abstract; extends `Animal`; declares a public constructor that passes its `kind` and `appearance` parameter values to its superclass constructor; overrides its `eat()` method to output `eats krill, algae, and insects`; and overrides its `move()` method to output `swims through the water`.



- `AmericanRobin` is public, extends `Bird`, and declares a public noargument constructor that passes "americanrobin" and "red breast" to its superclass constructor.
- `DomesticCanary` is public, extends `Bird`, and declares a public noargument constructor that passes "domesticcanary" and "yellow, orange, black, brown, white, red" to its superclass constructor.
- `RainbowTrout` is public, extends `Fish`, and declares a public noargument constructor that passes "rainbowtrout" and "bands of brilliant speckled multicolored stripes running nearly the whole length of its body" to its superclass constructor.
- `SockeyeSalmon` is public, extends `Fish`, and declares a public noargument constructor that passes "sockeyesalmon" and "bright red with a green head" to its superclass constructor.

**Note** For brevity, I have omitted from the `Animal` hierarchy abstract `Robin`, `Canary`, `Trout`, and `Salmon` classes that generalize robins, canaries, trout, and salmon. Perhaps you might want to include these classes in the hierarchy.

Although this exercise illustrates the accurate modeling of a natural scenario using inheritance, it also reveals the potential for *class explosion*—too many classes may be introduced to model a scenario, and it might be difficult to maintain all of these classes. Keep this in mind when modeling with inheritance.

50. Continuing from the previous exercise, declare an `Animals` class with a `main()` method. This method first declares an `animals` array that is initialized to `AmericanRobin`, `RainbowTrout`, `DomesticCanary`, and `SockeyeSalmon` objects. The method then iterates over this array, first outputting `animals[i]` (which causes `toString()` to be called) and then calling each object's `eat()` and `move()` methods (demonstrating subtype polymorphism).
51. Continuing from the previous exercise, declare a public `Countable` interface with a `String getID()` method. Modify `Animal` to implement `Countable` and have this method return kind's value. Modify `Animals` to initialize the `animals` array to `AmericanRobin`, `RainbowTrout`, `DomesticCanary`, `SockeyeSalmon`, `RainbowTrout`, and `AmericanRobin` objects. Also, introduce code that computes a census of each kind of animal. This code will use the `Census` class that is declared in Listing 4-30.

*Listing 4-30. The Census Class Stores Census Data on Four Kinds of Animals*

```
public class Census
{
    public final static int SIZE = 4;
    private String[] IDs;
    private int[] counts;
```

```
public Census()
{
    IDs = new String[SIZE];
    counts = new int[SIZE];
}

public String get(int index)
{
    return IDs[index] + " " + counts[index];
}

public void update(String ID)
{
    for (int i = 0; i < IDs.length; i++)
    {
        // If ID not already stored in the IDs array (which is indicated by
        // the first null entry that is found), store ID in this array, and
        // also assign 1 to the associated element in the counts array, to
        // initialize the census for that ID.
        if (IDs[i] == null)
        {
            IDs[i] = ID;
            counts[i] = 1;
            return;
        }

        // If a matching ID is found, increment the associated element in
        // the counts array to update the census for that ID.
        if (IDs[i].equals(ID))
        {
            counts[i]++;
            return;
        }
    }
}
}
```

---

## Summary

Inheritance is a hierarchical relationship between similar entity categories in which one category inherits state and behaviors from at least one other entity category. Inheriting from a single category is called single inheritance, and inheriting from at least two categories is called multiple inheritance.

Java supports single inheritance and multiple inheritance to facilitate code reuse—why reinvent the wheel? Java supports single inheritance in a class context (via reserved word `extends`), in which a class inherits fields and methods from another class through class extension. Because classes are involved, Java refers to this kind of inheritance as implementation inheritance. Java supports multiple inheritance only in an interface context, in which a class inherits method templates from one or more interfaces through interface implementation (via reserved word `implements`), or in which an interface inherits method templates from one or more interfaces through interface extension (via reserved word `extends`). Because interfaces are involved, Java refers to this kind of inheritance as interface inheritance.

Some real-world entities have the ability to change their forms. The ability to change form is known as polymorphism and is useful to model in a programming language. Although Java supports the coercion, overloading, parametric, and subtype kinds of polymorphism, in this chapter I focused only on subtype polymorphism, which is achieved through upcasting and method overriding.

Every class *X* exposes an interface (a protocol consisting of constructors, methods, and [possibly] fields that are made available to objects created from other classes for use in creating and communicating with *X*'s objects). Java formalizes the interface concept by providing reserved word `interface`, which is used to introduce a type without implementation.

Although many believe that the interfaces language feature was created as a workaround to Java's lack of support for multiple implementation inheritance, this is not the real reason for its existence. Instead, Java's interfaces feature was created to give developers the utmost flexibility in designing their applications by decoupling interface from implementation. You should always code to the interface.

Chapter 5 continues to explore the Java language by focusing on nested types, packages, static imports, and exceptions.

# Mastering Advanced Language Features, Part 1

In Chapters 2 through 4, I laid a foundation for learning the Java language. In Chapter 5, I will add to this foundation by introducing you to some of Java's more advanced language features, specifically those features related to nested types, packages, static imports, and exceptions. Additional advanced language features are covered in Chapter 6.

## Mastering Nested Types

Classes that are declared outside of any class are known as *top-level classes*. Java also supports *nested classes*, which are classes that are declared as members of other classes or scopes. Nested classes help you implement top-level class architecture.

There are four kinds of nested classes: static member classes, nonstatic member classes, anonymous classes, and local classes. The latter three categories are known as *inner classes*.

In this section, I will introduce you to static member classes and inner classes. For each kind of nested class, I will provide a brief introduction, an abstract example, and a more practical example. I will then briefly examine the topics of inner classes and memory leaks as well as nesting interfaces within classes and nesting classes within interfaces.

## Static Member Classes

A *static member class* is a static member of an enclosing class. Although enclosed, it doesn't have an enclosing instance of that class and cannot access the enclosing class's instance fields and invoke its instance methods. However, it can access the enclosing class's static fields and invoke its static methods, even those members that are declared *private*. Listing 5-1 presents a static member class declaration.

*Listing 5-1. Declaring a Static Member Class*

```
class EnclosingClass
{
    private static int i;

    private static void m1()
    {
        System.out.println(i);
    }

    static void m2()
    {
        EnclosedClass.accessEnclosingClass();
    }

    static class EnclosedClass
    {
        static void accessEnclosingClass()
        {
            i = 1;
            m1();
        }

        void accessEnclosingClass2()
        {
            m2();
        }
    }
}
```

Listing 5-1 declares a top-level class named `EnclosingClass` with class field `i`, class methods `m1()` and `m2()`, and static member class `EnclosedClass`. Also, `EnclosedClass` declares class method `accessEnclosingClass()` and instance method `accessEnclosingClass2()`.

Because `accessEnclosingClass()` is declared static, `m2()` must be prefixed with `EnclosedClass` and the member access operator to call this method.

Listing 5-2 presents the source code to an application class that demonstrates how to invoke `EnclosedClass`'s `accessEnclosingClass()` class method and instantiate `EnclosedClass` and invoke its `accessEnclosingClass2()` instance method.

*Listing 5-2. Invoking a Static Member Class's Class and Instance Methods*

```
public class SMCDemo
{
    public static void main(String[] args)
    {
        EnclosingClass.EnclosedClass.accessEnclosingClass(); // Output: 1
        EnclosingClass.EnclosedClass ec = new EnclosingClass.EnclosedClass();
        ec.accessEnclosingClass2(); // Output: 1
    }
}
```

Listing 5-2's `main()` method reveals that you must prefix the name of an enclosed class with the name of its enclosing class to invoke a class method, for example, `EnclosingClass.EnclosedClass.accessEnclosingClass()`;

This listing also reveals that you must prefix the name of the enclosed class with the name of its enclosing class when instantiating the enclosed class, for example, `EnclosingClass.EnclosedClass ec = new EnclosingClass.EnclosedClass()`; You can then invoke the instance method in the normal manner, for example, `ec.accessEnclosingClass2()`;

Static member classes have their uses. For example, Listing 5-3's `Double` and `Float` static member classes provide different implementations of their enclosing `Rectangle` class. The `Float` version occupies less memory because of its 32-bit float fields, and the `Double` version provides greater accuracy because of its 64-bit double fields.

*Listing 5-3. Using Static Member Classes to Declare Multiple Implementations of Their Enclosing Class*

```
abstract class Rectangle
{
    abstract double getX();
    abstract double getY();
    abstract double getWidth();
    abstract double getHeight();

    static class Double extends Rectangle
    {
        private double x, y, width, height;

        Double(double x, double y, double width, double height)
        {
            this.x = x;
            this.y = y;
            this.width = width;
            this.height = height;
        }

        double getX() { return x; }
        double getY() { return y; }
        double getWidth() { return width; }
        double getHeight() { return height; }
    }

    static class Float extends Rectangle
    {
        private float x, y, width, height;

        Float(float x, float y, float width, float height)
        {
            this.x = x;
            this.y = y;
            this.width = width;
            this.height = height;
        }
    }
}
```

```

    double getX() { return x; }
    double getY() { return y; }
    double getWidth() { return width; }
    double getHeight() { return height; }
}

// Prevent subclassing. Use the type-specific Double and Float
// implementation subclass classes to instantiate.
private Rectangle() {}

boolean contains(double x, double y)
{
    return (x >= getX() && x < getX() + getWidth()) &&
        (y >= getY() && y < getY() + getHeight());
}
}

```

Listing 5-3's `Rectangle` class demonstrates nested subclasses. Each of the `Double` and `Float` static member classes subclass the abstract `Rectangle` class, providing private floating-point or double precision floating-point fields and overriding `Rectangle`'s abstract methods to return these fields' values as doubles.

`Rectangle` is abstract because it makes no sense to instantiate this class. Because it also makes no sense to directly extend `Rectangle` with new implementations (the `Double` and `Float` nested subclasses should be sufficient), its default constructor is declared private. Instead, you must instantiate `Rectangle.Float` (to save memory) or `Rectangle.Double` (when accuracy is required), as demonstrated by Listing 5-4.

#### *Listing 5-4. Creating and Using Different Rectangle Implementations*

```

public class SMCDemo
{
    public static void main(String[] args)
    {
        Rectangle r = new Rectangle.Double(10.0, 10.0, 20.0, 30.0);
        System.out.println("x = " + r.getX());
        System.out.println("y = " + r.getY());
        System.out.println("width = " + r.getWidth());
        System.out.println("height = " + r.getHeight());
        System.out.println("contains(15.0, 15.0) = " + r.contains(15.0, 15.0));
        System.out.println("contains(0.0, 0.0) = " + r.contains(0.0, 0.0));
        System.out.println();
        r = new Rectangle.Float(10.0f, 10.0f, 20.0f, 30.0f);
        System.out.println("x = " + r.getX());
        System.out.println("y = " + r.getY());
        System.out.println("width = " + r.getWidth());
        System.out.println("height = " + r.getHeight());
        System.out.println("contains(15.0, 15.0) = " + r.contains(15.0, 15.0));
        System.out.println("contains(0.0, 0.0) = " + r.contains(0.0, 0.0));
    }
}

```

Listing 5-4 first instantiates `Rectangle`'s `Double` subclass via `new Rectangle.Double(10.0, 10.0, 20.0, 30.0)` and then invokes its various methods. Continuing, Listing 5-4 instantiates `Rectangle`'s `Float` subclass via `new Rectangle.Float(10.0f, 10.0f, 20.0f, 30.0f)` before invoking `Rectangle` methods on this instance.

Compile both listings (`javac SMCDemo.java` or `javac *.java`) and run the application (`java SMCDemo`). You will then observe the following output:

```
x = 10.0
y = 10.0
width = 20.0
height = 30.0
contains(15.0, 15.0) = true
contains(0.0, 0.0) = false

x = 10.0
y = 10.0
width = 20.0
height = 30.0
contains(15.0, 15.0) = true
contains(0.0, 0.0) = false
```

Java's class library contains many static member classes. For example, the `java.lang.Character` class encloses a static member class named `Subset` whose instances represent subsets of the Unicode character set. Additional examples include `java.util.AbstractMap.SimpleEntry` and `java.io.ObjectInputStream.GetField`.

**Note** When you compile an enclosing class that contains a static member class, the compiler creates a classfile for the static member class whose name consists of its enclosing class's name, a dollar-sign character, and the static member class's name. For example, compile Listing 5-1 and you will discover `EnclosingClass$EnclosedClass.class` in addition to `EnclosingClass.class`. This format also applies to nonstatic member classes.

## Nonstatic Member Classes

A *nonstatic member class* is a non-static member of an enclosing class. Each instance of the nonstatic member class implicitly associates with an instance of the enclosing class. The nonstatic member class's instance methods can call instance methods in the enclosing class and access the enclosing class instance's nonstatic fields. Listing 5-5 presents a nonstatic member class declaration.



*Listing 5-5. Declaring a Nonstatic Member Class*

```

class EnclosingClass
{
    private int i;

    private void m()
    {
        System.out.println(i);
    }

    class EnclosedClass
    {
        void accessEnclosingClass()
        {
            i = 1;
            m();
        }
    }
}

```

Listing 5-5 declares a top-level class named `EnclosingClass` with instance field `i`, instance method `m1()`, and nonstatic member class `EnclosedClass`. Furthermore, `EnclosedClass` declares instance method `accessEnclosingClass()`.

Because `accessEnclosingClass()` is nonstatic, `EnclosedClass` must be instantiated before this method can be called. This instantiation must take place via an instance of `EnclosingClass`. Listing 5-6 accomplishes these tasks.

*Listing 5-6. Calling a Nonstatic Member Class's Instance Method*

```

public class NSMCDemo
{
    public static void main(String[] args)
    {
        EnclosingClass ec = new EnclosingClass();
        ec.new EnclosedClass().accessEnclosingClass(); // Output: 1
    }
}

```

Listing 5-6's `main()` method first instantiates `EnclosingClass` and saves its reference in local variable `ec`. Then, `main()` uses this reference as a prefix to the `new` operator to instantiate `EnclosedClass`, whose reference is then used to call `accessEnclosingClass()`, which outputs 1.

**Note** Prefixing `new` with a reference to the enclosing class is rare. Instead, you will typically call an enclosed class's constructor from within a constructor or an instance method of its enclosing class.

Suppose you need to maintain a to-do list of items, where each item consists of a name and a description. After some thought, you create Listing 5-7's `ToDo` class to implement these items.

*Listing 5-7. Implementing To-Do Items as Name-Description Pairs*

```
class ToDo
{
    private String name;
    private String desc;

    ToDo(String name, String desc)
    {
        this.name = name;
        this.desc = desc;
    }

    String getName()
    {
        return name;
    }

    String getDesc()
    {
        return desc;
    }

    @Override
    public String toString()
    {
        return "Name = " + getName() + ", Desc = " + getDesc();
    }
}
```

You next create a `ToDoList` class to store `ToDo` instances. `ToDoList` uses its `ToDoArray` nonstatic member class to store `ToDo` instances in a growable array; you don't know how many instances will be stored, and Java arrays have fixed lengths. See Listing 5-8.

*Listing 5-8. Storing a Maximum of Two To-Do Instances in a ToDoArray Instance*

```
class ToDoList
{
    private ToDoArray toDoArray;
    private int index = 0;

    ToDoList()
    {
        toDoArray = new ToDoArray(2);
    }
}
```

```
boolean hasMoreElements()
{
    return index < toDoArray.size();
}

ToDo nextElement()
{
    return toDoArray.get(index++);
}

void add(ToDo item)
{
    toDoArray.add(item);
}

private class ToDoArray
{
    private ToDo[] toDoArray;
    private int index = 0;

    ToDoArray(int initSize)
    {
        toDoArray = new ToDo[initSize];
    }

    void add(ToDo item)
    {
        if (index >= toDoArray.length)
        {
            ToDo[] temp = new ToDo[toDoArray.length*2];
            for (int i = 0; i < toDoArray.length; i++)
                temp[i] = toDoArray[i];
            toDoArray = temp;
        }
        toDoArray[index++] = item;
    }

    ToDo get(int i)
    {
        return toDoArray[i];
    }

    int size()
    {
        return index;
    }
}
}
```

As well as providing an `add()` method to store `ToDo` instances in the `ToDoArray` instance, `ToDoList` provides `hasMoreElements()` and `nextElement()` methods to iterate over and return the stored instances. Listing 5-9 demonstrates these methods.

*Listing 5-9. Creating and Iterating Over a `ToDoList` of `ToDo` Instances*

```
public class NSMCDemo
{
    public static void main(String[] args)
    {
        ToDoList toDoList = new ToDoList();
        toDoList.add(new ToDo("#1", "Do laundry."));
        toDoList.add(new ToDo("#2", "Buy groceries."));
        toDoList.add(new ToDo("#3", "Vacuum apartment."));
        toDoList.add(new ToDo("#4", "Write report."));
        toDoList.add(new ToDo("#5", "Wash car."));
        while (toDoList.hasMoreElements())
            System.out.println(toDoList.nextElement());
    }
}
```

Compile all three listings (`javac NSMCDemo.java` or `javac *.java`) and run the application (`java NSMCDemo`). You will then observe the following output:

```
Name = #1, Desc = Do laundry.
Name = #2, Desc = Buy groceries.
Name = #3, Desc = Vacuum apartment.
Name = #4, Desc = Write report.
Name = #5, Desc = Wash car.
```

Java's class library presents many examples of nonstatic member classes. For example, the `java.util` package's `HashMap` class declares private `HashIterator`, `ValueIterator`, `KeyIterator`, and `EntryIterator` classes for iterating over a `HashMap`'s values, keys, and entries. (I will discuss `HashMap` in Chapter 9.)

**Note** Code within an enclosed class can obtain a reference to its enclosing class instance by qualifying reserved word `this` with the enclosing class's name and the member access operator. For example, if code within `accessEnclosingClass()` needed to obtain a reference to its `EnclosingClass` instance, it would specify `EnclosingClass.this`.

## Anonymous Classes

An *anonymous class* is a class without a name. Furthermore, it is not a member of its enclosing class. Instead, an anonymous class is simultaneously declared (as an anonymous extension of a class or as an anonymous implementation of an interface) and instantiated any place where it is legal to specify an expression. Listing 5-10 demonstrates an anonymous class declaration and instantiation.

Listing 5-10. Declaring and Instantiating an Anonymous Class That Extends a Class

```

abstract class Speaker
{
    abstract void speak();
}

public class ACDemo
{
    public static void main(final String[] args)
    {
        new Speaker()
        {
            String msg = (args.length == 1) ? args[0] : "nothing to say";

            @Override
            void speak()
            {
                System.out.println(msg);
            }
        }
        .speak();
    }
}

```

Listing 5-10 introduces an abstract class named `Speaker` and a concrete class named `ACDemo`. The latter class's `main()` method declares an anonymous class that extends `Speaker` and overrides its `speak()` method. When this method is called, it outputs `main()`'s first command-line argument or a default message when there are no arguments.

An anonymous class doesn't have a constructor (because the anonymous class doesn't have a name). However, its classfile does contain an `<init>()` method that performs instance initialization. This method calls the superclass's noargument constructor (prior to any other initialization), which is the reason for specifying `Speaker()` after `new`.

Anonymous class instances should be able to access the surrounding scope's local variables and parameters. However, an instance might outlive the method in which it was conceived (as a result of storing the instance's reference in a field), and try to access local variables and parameters that no longer exist after the method returns.

Because Java cannot allow this illegal access, which would most likely crash the virtual machine, it lets an anonymous class instance only access local variables and parameters that are declared `final` (see Listing 5-10). On encountering a `final` local variable/parameter name in an anonymous class instance, the compiler does one of two things:

- If the variable's type is primitive (`int` or `double`, for example), the compiler replaces its name with the variable's read-only value.
- If the variable's type is reference (`String`, for example), the compiler introduces, into the classfile, a *synthetic variable* (a manufactured variable) and code that stores the local variable's/parameter's reference in the synthetic variable.

Listing 5-11 demonstrates an alternative anonymous class declaration and instantiation.

*Listing 5-11. Declaring and Instantiating an Anonymous Class That Implements an Interface*

```
interface Speakable
{
    void speak();
}

public class ACDemo
{
    public static void main(final String[] args)
    {
        new Speakable()
        {
            String msg = (args.length == 1) ? args[0] : "nothing to say";

            @Override
            public void speak()
            {
                System.out.println(msg);
            }
        }
        .speak();
    }
}
```

Listing 5-11 is very similar to Listing 5-10. However, instead of subclassing a `Speaker` class, this listing's anonymous class implements an interface named `Speakable`. Apart from the `<init>()` method calling `java.lang.Object()` (interfaces have no constructors), Listing 5-11 behaves like Listing 5-10.

Although an anonymous class doesn't have a constructor, you can provide an instance initializer to handle complex initialization. For example, `new Office() {{addEmployee(new Employee("John Doe"));}}` instantiates an anonymous subclass of `Office` and adds one `Employee` object to this instance by calling `Office`'s `addEmployee()` method.

You will often find yourself creating and instantiating anonymous classes for their convenience. For example, suppose you need to return a list of all filenames having the `.java` suffix. The following example shows you how an anonymous class simplifies using the `java.io` package's `File` and `FilenameFilter` classes to achieve this objective:

```
String[] list = new File(directory).list(new FilenameFilter()
{
    @Override
    public boolean accept(File f, String s)
    {
        return s.endsWith(".java");
    }
});
```

However, keep in mind that there is a downside to using anonymous classes. Because they are anonymous, you cannot reuse anonymous classes in other parts of your applications.

## Local Classes

A *local class* is a class that is declared anywhere that a local variable is declared. Furthermore, it has the same scope as a local variable. Unlike an anonymous class, a local class has a name and can be reused. Like anonymous classes, local classes only have enclosing instances when used in nonstatic contexts.

A local class instance can access the surrounding scope's local variables and parameters. However, the local variables and parameters that are accessed must be declared `final`. For example, Listing 5-12's local class declaration accesses a final parameter and a final local variable.

*Listing 5-12. Declaring a Local Class*

```
class EnclosingClass
{
    void m(final int x)
    {
        final int y = x * 2;
        class LocalClass
        {
            int a = x;
            int b = y;
        }
        LocalClass lc = new LocalClass();
        System.out.println(lc.a);
        System.out.println(lc.b);
    }
}
```

Listing 5-12 declares `EnclosingClass` with its instance method `m()` declaring a local class named `LocalClass`. This local class declares a pair of instance fields (`a` and `b`) that are initialized to the values of final parameter `x` and final local variable `y` when `LocalClass` is instantiated: `new EnclosingClass().m(10);`, for example. Listing 5-13 demonstrates this local class.

*Listing 5-13. Demonstrating a Local Class*

```
public class LCDemo
{
    public static void main(String[] args)
    {
        EnclosingClass ec = new EnclosingClass();
        ec.m(10);
    }
}
```

After instantiating `EnclosingClass`, Listing 5-13's `main()` method invokes `m(10)`. The called `m()` method multiplies this argument by 2, instantiates `LocalClass`, whose `<init>()` method assigns the argument and the doubled value to its pair of instance fields (in lieu of using a constructor to perform this task); and outputs the `LocalClass` instance fields. The following output results:

Local classes help improve code clarity because they can be moved closer to where they are needed. For example, Listing 5-14 declares an `Iterator` interface and a `ToDoList` class whose `iterator()` method returns an instance of its local `Iter` class as an `Iterator` instance (because `Iter` implements `Iterator`).

*Listing 5-14. The Iterator Interface and the ToDoList Class*

```
interface Iterator
{
    boolean hasMoreElements();
    Object nextElement();
}

class ToDoList
{
    private ToDo[] toDoList;
    private int index = 0;

    ToDoList(int size)
    {
        toDoList = new ToDo[size];
    }

    Iterator iterator()
    {
        class Iter implements Iterator
        {
            int index = 0;

            @Override
            public boolean hasMoreElements()
            {
                return index < toDoList.length;
            }

            @Override
            public Object nextElement()
            {
                return toDoList[index++];
            }
        }
        return new Iter();
    }

    void add(ToDo item)
    {
        toDoList[index++] = item;
    }
}
```

Listing 5-15 demonstrates `Iterator`, the refactored `ToDoList` class, and Listing 5-7's `ToDo` class.



*Listing 5-15. Creating and Iterating Over a ToDoList of ToDo Instances with a Reusable Iterator*

```

public class LCDemo
{
    public static void main(String[] args)
    {
        ToDoList toDoList = new ToDoList(5);
        toDoList.add(new ToDo("#1", "Do laundry."));
        toDoList.add(new ToDo("#2", "Buy groceries."));
        toDoList.add(new ToDo("#3", "Vacuum apartment."));
        toDoList.add(new ToDo("#4", "Write report."));
        toDoList.add(new ToDo("#5", "Wash car."));
        Iterator iter = toDoList.iterator();
        while (iter.hasMoreElements())
            System.out.println(iter.nextElement());
    }
}

```

The `Iterator` instance that is returned from `iterator()` returns `ToDo` items in the same order as when they were added to the list. Although you can only use the returned `Iterator` object once, you can call `iterator()` whenever you need a new `Iterator` object. This capability is a big improvement over the one-shot iterator presented in Listing 5-9.

## Inner Classes and Memory Leaks

Instances of inner classes contain implicit references to their outer classes. Prolonging the existence of an inner class instance (such as storing its reference in a static variable) can result in a memory leak in which the outer instance may be referencing a large graph of objects that cannot be garbage collected because of the prolonged inner class reference. Consider Listing 5-16's example.

*Listing 5-16. Demonstrating a Memory Leak in the Context of a Local Class*

```

public class InnerLeakDemo
{
    public static void main(String[] args)
    {
        class Outer
        {
            String s = "outer string";

            class Inner
            {
                String s = "inner string";

                void print()
                {
                    System.out.println(s);
                    System.out.println(Outer.this.s);
                }
            }
        }
    }
}

```

```

    Outer o = new Outer();
    Outer.Inner oi = o.new Inner();
    oi.print();
}
}

```

Listing 5-16's `main()` method declares a local class named `Outer`, which declares a nonstatic member class named `Inner`. Each of `Outer` and `Inner` declares a `String` instance field named `s`, and `Inner` also declares a `print()` method.

After declaring `Outer`, `main()` instantiates this local class and then instantiates its nested `Inner` member. Finally, it invokes `Inner`'s `print()` method.

Compile Listing 5-16 (`javac InnerLeakDemo.java`) and run this application (`java InnerLeakDemo`). You should observe the following output:

```

inner string
outer string

```

This output reveals that `Outer`'s `s` field is present for as long as the reference to its `Inner` class exists. This is an example of a memory leak.

Although this example is trivial, you'll find it more profoundly demonstrated in an Android context, in which the inner class can outlive its activity outer class and delay the activity from being garbage collected and its resources released. To learn more about this problem, check out Alex Lockwood's "How to Leak a Context: Handlers & Inner Classes" blog post ([www.androiddesignpatterns.com/2013/01/inner-class-handler-memory-leak.html](http://www.androiddesignpatterns.com/2013/01/inner-class-handler-memory-leak.html)).

## Interfaces within Classes and Classes within Interfaces

Interfaces can be nested within classes. Once declared, an interface is considered to be static even when it is not declared `static`. For example, Listing 5-17 declares an enclosing class named `X` along with two nested static interfaces named `A` and `B`.

*Listing 5-17. Declaring a Pair of Interfaces Within a Class*

```

class X
{
    interface A
    {
    }

    static interface B
    {
    }
}

```

You would access Listing 5-17's interfaces in the same way. For example, you would specify `class C implements X.A {}` or `class D implements X.B {}`.

As with nested classes, nested interfaces help to implement top-level class architecture by being implemented by nested classes. Collectively, these types are nested because they cannot (as in Listing 5-14's `Iter` local class) or need not appear at the same level as a top-level class and pollute its package namespace. The `java.util.Map.Entry` interface and `HashMap` class is a good example.

Classes can be nested within interfaces. Once declared, a class is considered to be static even when it is not declared `static`. Although nowhere near as common as nesting an interface within a class, nested classes have a potential use, which Listing 5-18 demonstrates.

*Listing 5-18. Tightly Binding a Class to an Interface*

```
public interface Addressable
{
    class Address
    {
        private String boxNumber;
        private String street;
        private String city;

        public Address(String boxNumber, String street, String city)
        {
            this.boxNumber = boxNumber;
            this.street = street;
            this.city = city;
        }

        public String getBoxNumber()
        {
            return boxNumber;
        }

        public String getStreet()
        {
            return street;
        }

        public String getCity()
        {
            return city;
        }

        @Override
        public String toString()
        {
            return boxNumber+" - "+street+" - "+city;
        }
    }

    Address getAddress();
}
```

Listing 5-18 declares an `Addressable` interface that describes any entity associated with an address, such as a letter, parcel, or postcard. This interface declares an `Address` class to store the address components, and an `Address` `getAddress()` method that returns the address.

Assuming the existence of `Letter`, `Parcel`, and `Postcard` classes whose constructors take `Address` arguments, the following code fragment shows you how you could construct an array of addressables and then iterate over it, obtaining and printing each address:

```
Addressable[] addressables =
{
    new Letter(new Addressable.Address("10", "AnyStreet", "AnyTown")),
    new Parcel(new Addressable.Address("20", "Doe Street", "NewTown")),
    new Postcard(new Addressable.Address("30", "Ender Avenue", "AnyCity"))
};

for (int i = 0; i < addressables.length; i++)
    System.out.println(addressables[i].getAddress());
```

Notice that you must specify `Addressable.Address` to access the nested `Address` class. (You can use the static imports feature discussed in Chapter 6 to save yourself from typing the `Addressable.` prefix.)

Why nest `Address` instead of making it a separate top-level class? The idea here is that there exists a tight relationship between `Addressable` and `Address`, and you want to capture this relationship. Also, you might have a different top-level `Address` class and want to prevent a name conflict.

Nesting a class in an interface is considered by many to be a bad practice, because it goes against the ideas of object-oriented programming and the notion of an interface. However, you should be aware of this capability because you may encounter it in practice.

## Mastering Packages

Hierarchical structures organize items in terms of hierarchical relationships that exist between those items. For example, a filesystem might contain a `taxes` directory with multiple year subdirectories, where each subdirectory contains tax information pertinent to that year. Also, an enclosing class might contain multiple nested classes that only make sense in the context of the enclosing class.

Hierarchical structures also help to avoid name conflicts. For example, two files cannot have the same name in a nonhierarchical filesystem (which consists of a single directory). In contrast, a hierarchical filesystem lets same-named files exist in different directories. Similarly, two enclosing classes can contain same-named nested classes. Name conflicts don't exist because items are partitioned into different *namespaces*.

Java also supports the partitioning of top-level user-defined types into multiple namespaces to better organize these types and to also prevent name conflicts. Java uses packages to accomplish these tasks.

In this section, I will introduce you to packages. After defining this term and explaining why package names must be unique, I will present the package and import statements. I will next explain how the virtual machine searches for packages and types and then I will present an example that shows you how to work with packages. I will close this section by showing you how to encapsulate a package of classfiles into JAR files.

**Tip** Except for the most trivial of top-level types and (typically) those classes that serve as application entry points (they have `main()` methods), you should consider storing your types (especially when they are reusable) in packages. Get into the habit now because you'll use packages extensively when developing Android apps. Each Android app must be stored in its own unique package.

## What Are Packages?

A *package* is a unique namespace that can contain a combination of top-level classes, other top-level types, and subpackages. Only types that are declared `public` can be accessed from outside the package. Furthermore, the constants, constructors, methods, and nested types that describe a class's interface must be declared `public` to be accessible from beyond the package.

Every package has a name, which must be a nonreserved identifier. The member access operator separates a package name from a subpackage name and separates a package or subpackage name from a type name. For example, the two member access operators in `graphics.shapes.Circle` separate package name `graphics` from the `shapes` subpackage name and separate subpackage name `shapes` from the `Circle` type name.

**Note** Each of Oracle's and Google Android's standard class libraries organizes its many classes and other top-level types into multiple packages. Many of these packages are subpackages of the standard `java` package. Examples include `java.io` (types related to input/output operations), `java.lang` (language-oriented types), `java.net` (network-oriented types), and `java.util` (utility types).

## Package Names Must Be Unique

Suppose you have two different `graphics.shapes` packages, and suppose that each `shapes` subpackage contains a `Circle` class with a different interface. When the compiler encounters `System.out.println(new Circle(10.0, 20.0, 30.0).area());` in the source code, it needs to verify that the `area()` method exists.

The compiler will search all accessible packages until it finds a `graphics.shapes` package that contains a `Circle` class. If the found package contains the appropriate `Circle` class with an `area()` method, everything is fine. Otherwise, if the `Circle` class doesn't have an `area()` method, the compiler will report an error.

This scenario illustrates the importance of choosing unique package names. Specifically, the top-level package name must be unique. The convention in choosing this name is to take your Internet domain name and reverse it. For example, I would choose `ca.tutortutor` as my top-level package name because `tutortutor.ca` is my domain name. I would then specify `ca.tutortutor.graphics.shapes.Circle` to access `Circle`.

**Note** Reversed Internet domain names are not always valid package names. One or more of its component names might start with a digit (`6.com`), contain a hyphen (-) or other illegal character (`aq-x.com`), or be one of Java's reserved words (`int.com`). Convention dictates that you prefix the digit with an underscore (`com._6`), replace the illegal character with an underscore (`com.aq_x`), and suffix the reserved word with an underscore (`com.int_`).

## The Package Statement

The package statement identifies the package in which a source file's types are located. This statement consists of reserved word `package`, followed by a member access operator-separated list of package and subpackage names, followed by a semicolon.

For example, `package graphics;` specifies that the source file's types locate in a package named `graphics`, and `package graphics.shapes;` specifies that the source file's types locate in the `graphics` package's `shapes` subpackage.

By convention, a package name is expressed in lowercase. When the name consists of multiple words, each word except for the first word is capitalized.

Only one package statement can appear in a source file. When it is present, nothing apart from comments must precede this statement.

**Caution** Specifying multiple package statements in a source file or placing anything apart from comments above a package statement causes the compiler to report an error.

Java implementations map package and subpackage names to same-named directories. For example, an implementation would map `graphics` to a directory named `graphics` and would map `graphics.shapes` to a `shapes` subdirectory of `graphics`. The Java compiler stores the classfiles that implement the package's types in the corresponding directory.

**Note** When a source file doesn't contain a package statement, the source file's types are said to belong to the *unnamed package*. This package corresponds to the current directory.

## The Import Statement

Imagine having to repeatedly specify `ca.tutortutor.graphics.shapes.Circle` or some other lengthy package-qualified type name for each occurrence of that type in source code. Java provides an alternative that lets you avoid having to specify package details. This alternative is the import statement.

The import statement imports types from a package by telling the compiler where to look for unqualified type names during compilation. This statement consists of reserved word `import`, followed by a member access operator-separated list of package and subpackage names, followed by a type name or `*` (asterisk), followed by a semicolon.

The `*` symbol is a wildcard that represents all unqualified type names. It tells the compiler to look for such names in the import statement's specified package, unless the type name is found in a previously searched package. (Using the wildcard doesn't have a performance penalty or lead to code bloat but can lead to name conflicts, as you will see.)

For example, `import ca.tutortutor.graphics.shapes.Circle;` tells the compiler that an unqualified `Circle` class exists in the `ca.tutortutor.graphics.shapes` package. Similarly, `import ca.tutortutor.graphics.shapes.*;` tells the compiler to look in this package when it encounters a `Circle` class, a `Rectangle` class, or even an `Employee` class (if `Employee` hasn't already been found).

**Tip** You should avoid using the `*` wildcard so that other developers can easily see which types are used in source code.

Because Java is case sensitive, package and subpackage names specified in an import statement must be expressed in the same case as that used in the package statement.

When import statements are present in source code, only a package statement and comments can precede them.

**Caution** Placing anything other than a package statement, import statements, static import statements (discussed shortly), and comments above an import statement causes the compiler to report an error.

You can run into name conflicts when using the wildcard version of the import statement because any unqualified type name matches the wildcard. For example, you have `graphics.shapes` and `geometry` packages that each contain a `Circle` class, the source code begins with `import geometry.*;` and `import graphics.shape.*;` statements, and it also contains an unqualified occurrence of `Circle`. Because the compiler doesn't know if `Circle` refers to `geometry's Circle` class or `graphics.shape's Circle` class, it reports an error. You can fix this problem by qualifying `Circle` with the correct package name.

**Note** The compiler automatically imports the `String` class and other types from the `java.lang` package, which is why it's not necessary to qualify `String` with `java.lang`.

## Searching for Packages and Types

Newcomers to Java who first start to work with packages often become frustrated by “no class definition found” and other errors. This frustration can be partly avoided by understanding how the virtual machine searches for packages and types.

This section explains how the search process works. To understand this process, you need to realize that the compiler is a special Java application that runs under the control of the virtual machine. Furthermore, there are two different forms of search.

### Compile-Time Search

When the compiler encounters a type expression (such as a method call) in source code, it must locate that type’s declaration to verify that the expression is legal (a method exists in the type’s class whose parameter types match the types of the arguments passed in the method call, for example).

The compiler first searches the Java platform packages (which contain class library types). It then searches extension packages (for extension types). If the `-sourcepath` command-line option is specified when starting the virtual machine (via `javac`), the compiler searches the indicated path’s source files.

**Note** Java platform packages are stored in `rt.jar` and a few other important JAR files. Extension packages are stored in a special extensions directory named `ext`.

Otherwise, the compiler searches the user classpath (in left-to-right order) for the first user classfile or source file containing the type. If no user classpath is present, the current directory is searched. If no package matches or the type still cannot be found, the compiler reports an error. Otherwise, the compiler records the package information in the classfile.

**Note** The user classpath is specified via the `-classpath` (or `-cp`) option used to start the virtual machine or, when not present, the `CLASSPATH` environment variable.

### Runtime Search

When the compiler or any other Java application runs, the virtual machine will encounter types and must load their associated classfiles via special code known as a *classloader*. The virtual machine will use the previously stored package information that is associated with the encountered type in a search for that type’s classfile.



The virtual machine searches the Java platform packages, followed by extension packages, followed by the user classpath (in left-to-right order) for the first classfile that contains the type. If no user classpath is present, the current directory is searched. If no package matches or the type cannot be found, a “no class definition found” error is reported. Otherwise, the classfile is loaded into memory.

**Note** Whether you use the `-classpath/-cp` option or the `CLASSPATH` environment variable to specify a user classpath, there is a specific format that must be followed. Under Windows, this format is expressed as `path1;path2;...`, where `path1`, `path2`, and so on are the locations of package directories. Under Mac OS X, Unix, and Linux, this format changes to `path1:path2:...`

## Playing with Packages

Suppose your application needs to log messages to the console, to a file, or to another destination. It can accomplish this task with the help of a logging library. My implementation of this library consists of an interface named `Logger`, an abstract class named `LoggerFactory`, and a pair of package-private classes named `Console` and `File`.

**Note** The logging library that I present is an example of the *Abstract Factory design pattern*, which is presented on page 87 of *Design Patterns: Elements of Reusable Object-Oriented Software* by Erich Gamma, Richard Helm, Ralph Johnson, and John Vlissides (Addison-Wesley, 1995; ISBN: 0201633612).

Listing 5-19 presents the `Logger` interface, which describes objects that log messages.

*Listing 5-19. Describing Objects That Log Messages via the `Logger` Interface*

```
package logging;

public interface Logger
{
    boolean connect();
    boolean disconnect();
    boolean log(String msg);
}
```

Each of the `connect()`, `disconnect()`, and `log()` methods returns `true` upon success and `false` upon failure. (Later in this chapter, you will discover a better technique for dealing with failure.) These methods are not declared `public` explicitly because an interface’s methods are implicitly `public`.

Listing 5-20 presents the `LoggerFactory` abstract class.

*Listing 5-20. Obtaining a Logger for Logging Messages to a Specific Destination*

```

package logging;

public abstract class LoggerFactory
{
    public final static int CONSOLE = 0;
    public final static int FILE = 1;

    public static Logger newLogger(int dstType, String... dstName)
    {
        switch (dstType)
        {
            case CONSOLE: return new Console(dstName.length == 0 ? null
                                             : dstName[0]);
            case FILE    : return new File(dstName.length == 0 ? null
                                           : dstName[0]);
            default      : return null;
        }
    }
}

```

`newLogger()` returns a `Logger` object for logging messages to an appropriate destination. It uses the `varargs` (variable arguments) feature (see Chapter 3) to optionally accept an extra `String` argument for those destination types that require the argument. For example, `FILE` requires a filename.

Listing 5-21 presents the package-private `Console` class; this class is not accessible beyond the classes in the `logging` package because reserved word `class` is not preceded by reserved word `public`.

*Listing 5-21. Logging Messages to the Console*

```

package logging;

class Console implements Logger
{
    private String dstName;

    Console(String dstName)
    {
        this.dstName = dstName;
    }

    @Override
    public boolean connect()
    {
        return true;
    }
}

```

```
@Override
public boolean disconnect()
{
    return true;
}

@Override
public boolean log(String msg)
{
    System.out.println(msg);
    return true;
}
}
```

Console's package-private constructor saves its argument, which most likely will be `null` because there is no need for a `String` argument. Perhaps a future version of `Console` will use this argument to identify one of multiple console windows.

Listing 5-22 presents the package-private `File` class.

*Listing 5-22. Logging Messages to a File (Eventually)*

```
package logging;

class File implements Logger
{
    private String dstName;

    File(String dstName)
    {
        this.dstName = dstName;
    }

    @Override
    public boolean connect()
    {
        if (dstName == null)
            return false;
        System.out.println("opening file " + dstName);
        return true;
    }

    @Override
    public boolean disconnect()
    {
        if (dstName == null)
            return false;
        System.out.println("closing file " + dstName);
        return true;
    }
}
```

```

@Override
public boolean log(String msg)
{
    if (dstName == null)
        return false;
    System.out.println("writing "+msg+" to file " + dstName);
    return true;
}
}

```

Unlike `Console`, `File` requires a nonnull argument. Each method first verifies that this argument is not null. If the argument is null, the method returns false to signify failure. (In Chapter 11, I refactor `File` to incorporate appropriate file-writing code.)

The logging library allows us to introduce portable logging code into an application. Apart from a call to `newLogger()`, this code will remain the same regardless of the logging destination. Listing 5-23 presents an application that tests this library.

*Listing 5-23. Testing the Logging Library*

```

import logging.Logger;
import logging.LoggerFactory;

public class TestLogger
{
    public static void main(String[] args)
    {
        Logger logger = LoggerFactory.newLogger(LoggerFactory.CONSOLE);
        if (logger.connect())
        {
            logger.log("test message #1");
            logger.disconnect();
        }
        else
            System.out.println("cannot connect to console-based logger");
        logger = LoggerFactory.newLogger(LoggerFactory.FILE, "x.txt");
        if (logger.connect())
        {
            logger.log("test message #2");
            logger.disconnect();
        }
        else
            System.out.println("cannot connect to file-based logger");
        logger = LoggerFactory.newLogger(LoggerFactory.FILE);
        if (logger.connect())
        {
            logger.log("test message #3");
            logger.disconnect();
        }
        else
            System.out.println("cannot connect to file-based logger");
    }
}

```

Follow the steps (which assume that the JDK has been installed) to create the logging package and TestLogger application, and to run this application.

1. Create a new directory and make this directory current.
2. Create a logging directory in the current directory.
3. Copy Listing 5-19 to a file named `Logger.java` in the logging directory.
4. Copy Listing 5-20 to a file named `LoggerFactory.java` in the logging directory.
5. Copy Listing 5-21 to a file named `Console.java` in the logging directory.
6. Copy Listing 5-22 to a file named `File.java` in the logging directory.
7. Copy Listing 5-23 to a file named `TestLogger.java` in the current directory.
8. Execute `javac TestLogger.java`, which also compiles logger's source files.
9. Execute `java TestLogger`.

After completing these steps, you should observe the following output from the TestLogger application:

```
test message #1
opening file x.txt
writing test message #2 to file x.txt
closing file x.txt
cannot connect to file-based logger
```

What happens when logging is moved to another location? For example, move logging to the root directory and run TestLogger. You will now observe an error message about the virtual machine not finding the logging package and its LoggerFactory classfile.

You can solve this problem by specifying `-classpath/-cp` when running the java tool or by adding the location of the logging package to the CLASSPATH environment variable. For example, I chose to use `-classpath` (which I find more convenient) in the following Windows-specific command line:

```
java -classpath \;. TestLogger
```

The backslash represents the root directory in Windows. (I could have specified a forward slash as an alternative.) Also, the period represents the current directory. If it is missing, the virtual machine complains about not finding the TestLogger classfile.

**Tip** If you discover an error message where the virtual machine reports that it cannot find an application classfile, try appending a period character to the classpath. Doing so will probably fix the problem.

## Packages and JAR Files

The JDK provides a `jar` tool that is used to archive classfiles in *JAR* (Java ARchive) files and is also used to extract a JAR file's classfiles. It probably comes as no surprise that you can store packages in JAR files, which greatly simplify the distribution of your package-based class libraries.

To show you how easy it is to store a package in a JAR file, you will create a `logger.jar` file that contains the logging package's four classfiles (`Logger.class`, `LoggerFactory.class`, `Console.class`, and `File.class`). Complete the following steps to accomplish this task:

1. Make sure that the current directory contains the previously created logging directory with its four classfiles.
2. Execute the following command:

```
jar cf logger.jar logging\*.class
```

The `c` option stands for “create new archive” and the `f` option stands for “specify archive filename.”

You could alternatively execute the following command:

```
jar cf logger.jar logging/*.class
```

You should now find a `logger.jar` file in the current directory. To prove to yourself that this file contains the four classfiles, execute the following command, where the `t` option stands for “list table of contents”:

```
jar tf logger.jar
```

You can run `TestLogger.class` by adding `logger.jar` to the classpath. For example, you can run `TestLogger` under Windows via the following command:

```
java -classpath logger.jar;. TestLogger
```

**Note** Although you can create your own logging framework, doing so is a waste of time. Instead, you should leverage the `java.util.logging` package (see Chapter 16) that's included in the standard class library.

## Mastering Static Imports

An interface should only be used to declare a type. However, some developers violate this principle by using interfaces to only export constants. Such interfaces are known as *constant interfaces*, and Listing 5-24 presents an example.

*Listing 5-24. Declaring a Constant Interface*

```
interface Directions
{
    int NORTH = 0;
    int SOUTH = 1;
    int EAST = 2;
    int WEST = 3;
}
```

Developers who resort to constant interfaces do so to avoid having to prefix a constant's name with the name of its class (as in `Math.PI`, where `PI` is a constant in the `java.lang.Math` class). They do this by implementing the interface (see Listing 5-25).

*Listing 5-25. Implementing a Constant Interface*

```
public class TrafficFlow implements Directions
{
    public static void main(String[] args)
    {
        showDirection((int) (Math.random()* 4));
    }

    static void showDirection(int dir)
    {
        switch (dir)
        {
            case NORTH: System.out.println("Moving north"); break;
            case SOUTH: System.out.println("Moving south"); break;
            case EAST : System.out.println("Moving east"); break;
            case WEST : System.out.println("Moving west");
        }
    }
}
```

Listing 5-25's `TrafficFlow` class implements `Directions` for the sole purpose of not having to specify `Directions.NORTH`, `Directions.SOUTH`, `Directions.EAST`, and `Directions.WEST`.

This is an appalling misuse of an interface. These constants are nothing more than an implementation detail that should not be allowed to leak into the class's exported *interface* because they might confuse the class's users (what is the purpose of these constants?). Also, they represent a future commitment: even when the class no longer uses these constants, the interface must remain to ensure binary compatibility.

Java 5 introduced an alternative that satisfies the desire for constant interfaces while avoiding their problems. This static imports feature lets you import a class's static members so that you don't have to qualify them with their class names. It's implemented via a small modification to the import statement, as follows:

```
import static packagespec . classname . ( staticmembername | * );
```

The static import statement specifies `static` after `import`. It then specifies a member access operator-separated list of package and subpackage names, which is followed by the member access operator and a class's name. Once again, the member access operator is specified, followed by a single static member name or the asterisk wildcard.

**Caution** Placing anything apart from a package statement, `import/static import` statements, and comments above a static import statement causes the compiler to report an error.

You specify a single static member name to import only that name.

```
import static java.lang.Math.PI; // Import the PI static field only.
import static java.lang.Math.cos; // Import the cos() static method only.
```

In contrast, you specify the wildcard to import all static member names.

```
import static java.lang.Math.*; // Import all static members from Math.
```

You can now refer to the static member(s) without having to specify the class name.

```
System.out.println(cos(PI));
```

Using multiple static import statements can result in name conflicts, which causes the compiler to report errors. For example, suppose your `geom` package contains a `Circle` class with a static member named `PI`. Now suppose you specify `import static java.lang.Math.*;` and `import static geom.Circle.*;` at the top of your source file. Finally, suppose you specify `System.out.println(PI);` somewhere in that file's code. The compiler reports an error because it doesn't know whether `PI` belongs to `Math` or to `Circle`.

**Caution** Overuse of static imports can make your code unreadable and unmaintainable. Anyone reading your code could have a hard time finding out which class a static member comes from, especially when importing all static member names from a class. Also, static imports pollute the code's namespace with all of the static members you import. Eventually, you may run into name conflicts that are hard to resolve.

## Mastering Exceptions

In an ideal world, nothing bad ever happens when an application runs. For example, a file always exists when the application needs to open the file, the application is always able to connect to a remote computer, and the virtual machine never runs out of memory when the application needs to instantiate objects.



In contrast, real-world applications occasionally attempt to open files that don't exist, attempt to connect to remote computers that are unable to communicate with them, and require more memory than the virtual machine can provide. Your goal is to write code that properly responds to these and other exceptional situations (exceptions).

This section introduces you to exceptions. After defining this term, I will look at representing exceptions in source code. I will then examine the topics of throwing and handling exceptions and conclude by discussing how to perform cleanup tasks before a method returns, whether or not an exception has been thrown.

## What Are Exceptions?

An *exception* is a divergence from an application's normal behavior. For example, the application attempts to open a nonexistent file for reading. The normal behavior is to successfully open the file and begin reading its contents. However, the file cannot be read when the file doesn't exist.

This example illustrates an exception that cannot be prevented. However, a workaround is possible. For example, the application can detect that the file doesn't exist and take an alternate course of action, which might include telling the user about the problem. Unpreventable exceptions where workarounds are possible must not be ignored.

Exceptions can occur because of poorly written code. For example, an application might contain code that accesses each element in an array. Because of careless oversight, the array-access code might attempt to access a nonexistent array element, which leads to an exception. This kind of exception is preventable by writing correct code.

Finally, an exception might occur that cannot be prevented and for which there is no workaround. For example, the virtual machine might run out of memory, or perhaps it cannot find a classfile. This kind of exception, known as an *error*, is so serious that it's impossible (or at least inadvisable) to work around; the application must terminate, presenting a message to the user that explains why it's terminating.

## Representing Exceptions in Source Code

An exception can be represented via error codes or objects. After discussing each kind of representation and explaining why objects are superior, I will introduce you to Java's exception and error class hierarchy, emphasizing the difference between checked and runtime exceptions. I will close my discussion on representing exceptions in source code by discussing custom exception classes.

### Error Codes vs. Objects

One way to represent exceptions in source code is to use error codes. For example, a method might return true on success and false when an exception occurs. Alternatively, a method might return 0 on success and a nonzero integer value that identifies a specific kind of exception.

Developers traditionally designed methods to return error codes; I demonstrated this tradition in each of the three methods in Listing 5-19's `Logger` interface. Each method returns true on success or returns false to represent an exception (unable to connect to the logger, for example).

Although a method's return value must be examined to see if it represents an exception, error codes are all too easy to ignore. For example, a lazy developer might ignore the return code from `Logger`'s `connect()` method and attempt to call `log()`. Ignoring error codes is one reason why a new approach to dealing with exceptions has been invented.

This new approach is based on objects. When an exception occurs, an object representing the exception is created by the code that was running when the exception occurred. Details describing the exception's surrounding context are stored in the object. These details are later examined to work around the exception.

The object is then *thrown* or handed off to the virtual machine to search for a *handler*, code that can handle the exception. (If the exception is an error, the application should not provide a handler because errors are so serious [such as the virtual machine has run out of memory] that there's practically nothing that can be done about them.) When a handler is located, its code is executed to provide a workaround. Otherwise, the virtual machine terminates the application.

**Caution** Code that handles exceptions can be a source of bugs because it's often not thoroughly tested. Always make sure to test any code that handles exceptions.

Apart from being too easy to ignore, an error code's Boolean or integer value is less meaningful than an object name. For example, `fileNotFound` is self-evident, but what does `false` mean? Also, an object can contain information about what led to the exception. These details can be helpful to a suitable workaround.

## The Throwable Class Hierarchy

Java provides a hierarchy of classes that represent different kinds of exceptions. These classes are rooted in `java.lang.Throwable`, the ultimate superclass for all *throwables* (exception and error objects—exceptions and errors, for short—that can be thrown). Figure 5-1 reveals `Throwable` and its immediate subclasses.

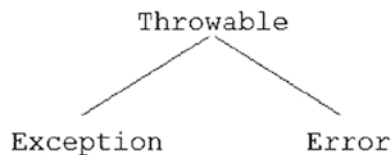

**Figure 5-1.** The exceptions hierarchy is rooted in the `Throwable` class

`Exception` is the root class for all exception-oriented throwables. Similarly, `Error` is the root class for all error-oriented throwables.

Table 5-1 identifies and describes most of `Throwable`'s constructors and methods.

**Table 5-1. Throwable's Constructors and Methods**

Method	Description
<code>Throwable()</code>	Create a throwable with a null detail message and cause.
<code>Throwable(String message)</code>	Create a throwable with the specified detail message and a null cause.
<code>Throwable(String message, Throwable cause)</code>	Create a throwable with the specified detail message and cause.
<code>Throwable(Throwable cause)</code>	Create a throwable whose detail message is the string representation of a nonnull cause or null.
<code>Throwable fillInStackTrace()</code>	Fill in the execution stack trace. This method records information about the current state of the stack frames for the current thread within this throwable. (I discuss threads in Chapter 7.)
<code>Throwable getCause()</code>	Return the cause of this throwable. When there is no cause, null is returned.
<code>String getMessage()</code>	Return this throwable's detail message, which might be null.
<code>StackTraceElement[] getStackTrace()</code>	Provide programmatic access to the stack trace information printed by <code>printStackTrace()</code> as an array of stack trace elements, each representing one stack frame.
<code>Throwable initCause(Throwable cause)</code>	Initialize the cause of this throwable to the specified value.
<code>void printStackTrace()</code>	Print this throwable and its backtrace of stack frames to the standard error stream.
<code>void setStackTrace(StackTraceElement[] stackTrace)</code>	Set the stack trace elements that will be returned by <code>getStackTrace()</code> and printed by <code>printStackTrace()</code> and related methods.

It's not uncommon for a class's public methods to call helper methods that throw various exceptions. A public method will probably not document exceptions thrown from a helper method because they are implementation details that often should not be visible to the public method's caller.

However, because this exception might be helpful in diagnosing the problem, the public method can wrap the lower-level exception in a higher-level exception that is documented in the public method's contract interface. The wrapped exception is known as a *cause* because its existence causes the higher-level exception to be thrown.

A cause is created by invoking the `Throwable(Throwable cause)` or `Throwable(String message, Throwable cause)` constructor, which invoke the `initCause()` method to store the cause. If you don't call either constructor, you can alternatively call `initCause()` directly, but you must do so immediately after creating the throwable. Call the `getCause()` method to return the cause.

When an exception is thrown, it leaves behind a stack of unfinished method calls. Throwable's constructors call `fillInStackTrace()` to record this stack trace information, which is output by calling `printStackTrace()`.

The `getStackTrace()` method provides programmatic access to the stack trace by returning this information as an array of `java.lang.StackTraceElement` instances—each instance represents one entry. `StackTraceElement` provides methods to return stack trace information. For example, `String getMethodName()` returns the name of an unfinished method.

The `setStackTrace()` method is designed for use by Remote Procedure Call (RPC) frameworks (see [http://en.wikipedia.org/wiki/Remote\\_procedure\\_call](http://en.wikipedia.org/wiki/Remote_procedure_call)) and other advanced systems, allowing the client to override the default stack trace that is generated by `fillInStackTrace()` when a throwable is constructed or deserialized when a throwable is read from a serialization stream. (I will discuss serialization in Chapter 11.)

Moving down the throwable hierarchy, you encounter the `java.lang.Exception` and `java.lang.Error` classes, which respectively represent exceptions and errors. Each class offers four constructors that pass their arguments to their `Throwable` counterparts but provides no methods apart from those that are inherited from `Throwable`.

`Exception` is itself subclassed by `java.lang.CloneNotSupportedException` (discussed in Chapter 4), `java.lang.IOException` (discussed in Chapter 11), and other classes. Similarly, `Error` is itself subclassed by `java.lang.AssertionError` (discussed in Chapter 6), `java.lang.OutOfMemoryError`, and other classes.

**Caution** Never instantiate `Throwable`, `Exception`, or `Error`. The resulting objects are meaningless because they are too generic.

## Checked Exceptions vs. Runtime Exceptions

A *checked exception* is an exception that represents a problem with the possibility of recovery and for which the developer must provide a workaround. The compiler checks the code to ensure that the exception is handled in the method where it is thrown, or is explicitly identified as being handled elsewhere.

`Exception` and all subclasses except for `java.lang.RuntimeException` (and its subclasses) describe checked exceptions. For example, the `CloneNotSupportedException` and `IOException` classes describe checked exceptions. (`CloneNotSupportedException` should not be checked because there is no runtime workaround for this kind of exception.)

A *runtime exception* is an exception that represents a coding mistake. This kind of exception is also known as an *unchecked exception* because it doesn't need to be handled or explicitly identified—the mistake must be fixed. Because these exceptions can occur in many places, it would be burdensome to be forced to handle them.

`RuntimeException` and its subclasses describe unchecked exceptions. For example, `java.lang.ArithmeticException` describes arithmetic problems such as integer division by zero. Another example is `java.lang.ArrayIndexOutOfBoundsException`, which is thrown when you attempt to access an array element with a negative index or an index that is greater than or equal to the length of the array. (In hindsight, `RuntimeException` should have been named `UncheckedException` because all exceptions occur at runtime.)

**Note** Many developers are unhappy with checked exceptions because of the work involved in having to handle them. This problem is made worse by libraries providing methods that throw checked exceptions when they should throw unchecked exceptions. As a result, many modern languages support only unchecked exceptions.

## Custom Exception Classes

You can declare your own exception classes. Before doing so, ask yourself if an existing exception class in the standard class library meets your needs. If you find a suitable class, you should reuse it. (Why reinvent the wheel?) Other developers will already be familiar with the existing class, and this knowledge will make your code easier to learn. When no existing class meets your needs, think about whether to subclass `Exception` or `RuntimeException`. In other words, will your exception class be checked or unchecked? As a rule of thumb, your class should subclass `RuntimeException` if you think that it will describe a coding mistake.

**Tip** When you name your class, follow the convention of providing an `Exception` suffix. This suffix clarifies that your class describes an exception.

Suppose you are creating a `Media` class whose static methods are to perform media-oriented utility tasks. For example, one method converts sound files in non-MP3 media formats to MP3 format. This method will be passed source file and destination file arguments and will convert the source file to the format implied by the destination file's extension.

Before performing the conversion, the method needs to verify that the source file's format agrees with the format implied by its file extension. If there is no agreement, an exception must be thrown. Furthermore, this exception must store the expected and existing media formats so that a handler can identify them when presenting a message to the user.

Because Java's class library doesn't provide a suitable exception class, you decide to introduce a class named `InvalidMediaFormatException`. Detecting an invalid media format is not the result of a coding mistake, and so you also decide to extend `Exception` to indicate that the exception is checked. Listing 5-26 presents this class's declaration.

### *Listing 5-26. Declaring a Custom Exception Class*

```
package media;

public class InvalidMediaFormatException extends Exception
{
    private String expectedFormat;
    private String existingFormat;
```

```

public InvalidFormatException(String expectedFormat,
                             String existingFormat)
{
    super("Expected format: " + expectedFormat + ", Existing format: " +
          existingFormat);
    this.expectedFormat = expectedFormat;
    this.existingFormat = existingFormat;
}

public String getExpectedFormat()
{
    return expectedFormat;
}

public String getExistingFormat()
{
    return existingFormat;
}
}

```

`InvalidFormatException` provides a constructor that calls `Exception`'s public `Exception(String message)` constructor with a detail message that includes the expected and existing formats. It is wise to capture such details in the detail message because the problem that led to the exception might be hard to reproduce.

`InvalidFormatException` also provides `getExpectedFormat()` and `getExistingFormat()` methods that return these formats. Perhaps a handler will present this information in a message to the user. Unlike the detail message, this message might be *localized*, expressed in the user's language (French, German, English, and so on).

## Throwing Exceptions

Now that you have created an `InvalidFormatException` class, you can declare the `Media` class and begin to code its `convert()` method. The initial version of this method validates its arguments and then verifies that the source file's media format agrees with the format implied by its file extension. Check out Listing 5-27.

*Listing 5-27. Throwing Exceptions from the `convert()` Method*

```

package media;

import java.io.IOException;

public final class Media
{
    public static void convert(String srcName, String dstName)
        throws InvalidFormatException, IOException
    {
        if (srcName == null)
            throw new NullPointerException(srcName + " is null");
    }
}

```

```

    if (dstName == null)
        throw new NullPointerException(dstName + " is null");
    // Code to access source file and verify that its format matches the
    // format implied by its file extension.
    //
    // Assume that the source file's extension is RM (for Real Media) and
    // that the file's internal signature suggests that its format is
    // Microsoft WAVE.
    String expectedFormat = "RM";
    String existingFormat = "WAVE";
    throw new InvalidMediaFormatException(expectedFormat, existingFormat);
}
}

```

Listing 5-27 declares the `Media` class to be `final` because this utility class will only consist of class methods and there's no reason to extend it.

`Media`'s `convert()` method appends `throws InvalidMediaFormatException, IOException` to its header. A *throws clause* identifies all checked exceptions that are thrown out of the method and must be handled by some other method. It consists of reserved word `throws` followed by a comma-separated list of checked exception class names and is always appended to a method header. The `convert()` method's `throws` clause indicates that this method is capable of throwing an `InvalidMediaException` or `IOException` instance to the virtual machine.

`convert()` also demonstrates the `throw` statement, which consists of reserved word `throw` followed by an instance of `Throwable` or a subclass. (You will typically instantiate an `Exception` subclass.) This statement throws the instance to the virtual machine, which then searches for a suitable handler to handle the exception.

The first use of the `throw` statement is to throw a `java.lang.NullPointerException` instance when a null reference is passed as the source or destination filename. This unchecked exception is commonly thrown to indicate that a contract has been violated via a passed null reference. For example, you cannot pass null filenames to `convert()`.

The second use of the `throw` statement is to throw a `media.InvalidMediaFormatException` instance when the expected media format doesn't match the existing format. In the contrived example, the exception is thrown because the expected format is `RM` and the existing format is `WAVE`.

Unlike `InvalidMediaFormatException`, `NullPointerException` is not listed in `convert()`'s `throws` clause because `NullPointerException` instances are unchecked. They can occur so frequently that it is too big a burden to force the developer to properly handle these exceptions. Instead, the developer should write code that minimizes their occurrences.

Although not thrown from `convert()`, `IOException` is listed in this method's `throws` clause in preparation for refactoring this method to perform the conversion with the help of file-handling code.

`NullPointerException` is one kind of exception that is thrown when an argument proves to be invalid. The `java.lang.IllegalArgumentException` class generalizes the illegal argument scenario to include other kinds of illegal arguments. For example, the following method throws an `IllegalArgumentException` instance when a numeric argument is negative:

```
public static double sqrt(double x)
{
    if (x < 0)
        throw new IllegalArgumentException(x + " is negative");
    // Calculate the square root of x.
}
```

There are a few additional items to keep in mind when working with throws clauses and throw statements:

- You can append a throws clause to a constructor and throw an exception from the constructor when something goes wrong while the constructor is executing. The resulting object will not be created.
- When an exception is thrown out of an application's `main()` method, the virtual machine terminates the application and calls the exception's `printStackTrace()` method to print, to the console, the sequence of nested method calls that was awaiting completion when the exception was thrown.
- If a superclass method declares a throws clause, the overriding subclass method doesn't have to declare a throws clause. However, if the subclass method does declare a throws clause, the clause must not include the names of checked exception classes that are not also included in the superclass method's throws clause, unless they are the names of exception subclasses. For example, given superclass method `void foo() throws IOException {}`, the overriding subclass method could be declared as `void foo() {}`, `void foo() throws IOException {}`, or `void foo() throws FileNotFoundException {}`; the `java.io.FileNotFoundException` class subclasses `IOException`.
- A checked exception class name doesn't need to appear in a throws clause when the name of its superclass appears.
- The compiler reports an error when a method throws a checked exception and doesn't also handle the exception or list the exception in its throws clause.
- If at all possible, don't include the names of unchecked exception classes in a throws clause. These names are not required because such exceptions should never occur. Furthermore, they only clutter source code and possibly confuse someone who is trying to understand that code.
- You can declare a checked exception class name in a method's throws clause without throwing an instance of this class from the method. (Perhaps the method has yet to be fully coded.) However, Java requires that you provide code to handle this exception, even though it is not thrown.



## Handling Exceptions

A method indicates its intention to handle one or more exceptions by specifying a try statement that includes one or more appropriate catch blocks. The try statement consists of reserved word `try` followed by a brace-delimited body. You place code that throws exceptions into this block.

A catch block consists of reserved word `catch`, followed by a round bracket-delimited single-parameter list that specifies an exception class name, followed by a brace-delimited body. You place code that handles exceptions whose types match the type of the catch block's parameter list's exception class parameter in this block.

A catch block is specified immediately after a try block. When an exception is thrown, the virtual machine will search for a handler. It first examines the catch block to see whether its parameter type matches or is the superclass type of the exception that has been thrown.

If the catch block is found, its body executes and the exception is handled. Otherwise, the virtual machine proceeds up the method-call stack, looking for the first method whose try statement contains an appropriate catch block. This process continues unless a catch block is found or execution leaves the `main()` method.

The following example illustrates try and catch:

```
try
{
    int x = 1 / 0;
}
catch (ArithmeticException ae)
{
    System.out.println("attempt to divide by zero");
}
```

When execution enters the try block, an attempt is made to divide integer 1 by integer 0. The virtual machine responds by instantiating `ArithmeticException` and throwing this exception. It then detects the catch block, which is capable of handling thrown `ArithmeticException` objects, and transfers execution to this block, which invokes `System.out.println()` to output a suitable message; the exception is handled.

Because `ArithmeticException` is an example of an unchecked exception type, and because unchecked exceptions represent coding mistakes that must be fixed, you typically don't catch them, as demonstrated previously. Instead, you would fix the problem that led to the thrown exception.

**Tip** You might want to name your catch block parameters using the abbreviated style shown in the preceding section. Not only does this convention result in more meaningful exception-oriented parameter names (`ae` indicates that an `ArithmeticException` has been thrown), it can help reduce compiler errors. For example, it is common practice to name a catch block's parameter `e`, for convenience. (Why type a long name?) However, the compiler will report an error when a previously declared local variable or parameter also uses `e` as its name; multiple same-named local variables and parameters cannot exist in the same scope.

## Handling Multiple Exception Types

You can specify multiple catch blocks after a try block. For example, Listing 5-27's `convert()` method specifies a `throws` clause indicating that `convert()` can throw `InvalidFormatException`, which is currently thrown, and `IOException`, which will be thrown when `convert()` is refactored. This refactoring will result in `convert()` throwing `IOException` when it cannot read from the source file or write to the destination file and throwing `FileNotFoundException` (a subclass of `IOException`) when it cannot open the source file or create the destination file. All these exceptions must be handled, as demonstrated in Listing 5-28.

*Listing 5-28. Handling Different Kinds of Exceptions*

```
import java.io.FileNotFoundException;
import java.io.IOException;

import media.InvalidFormatException;
import media.Media;

public class Converter
{
    public static void main(String[] args)
    {
        if (args.length != 2)
        {
            System.err.println("usage: java Converter srcfile dstfile");
            return;
        }
        try
        {
            Media.convert(args[0], args[1]);
        }
        catch (InvalidFormatException imfe)
        {
            System.out.println("Unable to convert " + args[0] + " to " + args[1]);
            System.out.println("Expecting " + args[0] + " to conform to " +
                imfe.getExpectedFormat() + " format.");
            System.out.println("However, " + args[0] + " conformed to " +
                imfe.getExistingFormat() + " format.");
        }
        catch (FileNotFoundException fnfe)
        {
        }
        catch (IOException ioe)
        {
        }
    }
}
```

The call to `Media`'s `convert()` method in Listing 5-28 is placed in a try block because this method is capable of throwing an instance of the checked `InvalidFormatException`, `IOException`, or `FileNotFoundException` class; checked exceptions must be handled or be declared to be thrown via a `throws` clause that is appended to the method.

The catch (`InvalidFormatException imfe`) block's statements are designed to provide a descriptive error message to the user. A more sophisticated application would *localize* these names so that the user could read the message in the user's language. The developer-oriented detail message is not output because it is not necessary in this trivial application.

**Note** A developer-oriented detail message is typically not localized. Instead, it is expressed in the developer's language. Users should never see detail messages.

Although not thrown, a catch block for `IOException` is required because this checked exception type appears in `convert()`'s throws clause. Because the catch (`IOException ioe`) block can also handle thrown `FileNotFoundException` instances (because `FileNotFoundException` subclasses `IOException`), the catch (`FileNotFoundException fnfe`) block isn't necessary at this point but is present to separate out the handling of a situation where a file cannot be opened for reading or created for writing (which will be addressed once `convert()` is refactored to include file code).

Assuming that the current directory contains Listing 5-28 and a `media` subdirectory containing `InvalidFormatException.java` and `Media.java`, compile this listing (`javac Converter.java`), which also compiles `media`'s source files, and run the application, as in `java Converter A B`. `Converter` responds by presenting the following output:

```
Unable to convert A to B
Expecting A to conform to RM format.
However, A conformed to WAVE format.
```

Listing 5-28's empty `FileNotFoundException` and `IOException` catch blocks illustrate the often-seen problem of leaving catch blocks empty because they are inconvenient to code. Unless you have a good reason, don't create an empty catch block. It swallows exceptions and you don't know that the exceptions were thrown. (For brevity, I don't always code catch blocks in this book's examples.)

**Caution** The compiler reports an error when you specify two or more catch blocks with the same parameter type after a try body. Example: `try {} catch (IOException ioe1) {} catch (IOException ioe2) {}`. You must merge these catch blocks into one block.

Although you can write catch blocks in any order, the compiler restricts this order when one catch block's parameter is a supertype of another catch block's parameter. The subtype parameter catch block must precede the supertype parameter catch block; otherwise, the subtype parameter catch block will never be executed.

For example, the `FileNotFoundException` catch block must precede the `IOException` catch block. If the compiler allowed the `IOException` catch block to be specified first, the `FileNotFoundException` catch block would never execute because a `FileNotFoundException` instance is also an instance of its `IOException` superclass.

## Rethrowing Exceptions

While discussing the `Throwable` class, I discussed wrapping lower-level exceptions in higher-level exceptions. This activity will typically take place in a `catch` block and is illustrated in the following example:

```
catch (IOException ioe)
{
    throw new ReportCreationException(ioe);
}
```

This example assumes that a helper method has just thrown a generic `IOException` instance as the result of trying to create a report. The public method's contract states that `ReportCreationException` is thrown in this case. To satisfy the contract, the latter exception is thrown. To satisfy the developer who is responsible for debugging a faulty application, the `IOException` instance is wrapped inside the `ReportCreationException` instance that is thrown to the public method's caller.

Sometimes, a `catch` block might not be able to fully handle an exception. Perhaps it needs access to information provided by some ancestor method in the method-call stack. However, the `catch` block might be able to partly handle the exception. In this case, it should partly handle the exception, and then rethrow the exception so that a handler in an ancestor method can finish handling it. Another possibility is to log the exception (for later analysis), which is demonstrated in the following example:

```
catch (FileNotFoundException fnfe)
{
    logger.log(fnfe);
    throw fnfe; // Rethrow the exception here.
}
```

## Performing Cleanup

In some situations, you might want to execute cleanup code before execution leaves a method following a thrown exception. For example, you might want to close a file that was opened, but could not be written, possibly because of insufficient disk space. Java provides the `finally` block for this situation.

The `finally` block consists of reserved word `finally` followed by a body, which provides the cleanup code. A `finally` block follows either a `catch` block or a `try` block. In the former case, the exception may be handled (and possibly rethrown) before `finally` executes. In the latter case, the exception is handled (and possibly rethrown) after `finally` executes.

Listing 5-29 demonstrates the first scenario in the context of a simulated file-copying application's `main()` method.

*Listing 5-29. Cleaning Up by Closing Files After Handling a Thrown Exception*

```
import java.io.IOException;

public class Copy
{
    public static void main(String[] args)
```

```
{
    if (args.length != 2)
    {
        System.err.println("usage: java Copy srcFile dstFile");
        return;
    }

    int fileHandleSrc = 0;
    int fileHandleDst = 1;
    try
    {
        fileHandleSrc = open(args[0]);
        fileHandleDst = create(args[1]);
        copy(fileHandleSrc, fileHandleDst);
    }
    catch (IOException ioe)
    {
        System.err.println("I/O error: " + ioe.getMessage());
        return;
    }
    finally
    {
        close(fileHandleSrc);
        close(fileHandleDst);
    }
}

static int open(String filename)
{
    return 1; // Assume that filename is mapped to integer.
}

static int create(String filename)
{
    return 2; // Assume that filename is mapped to integer.
}

static void close(int fileHandle)
{
    System.out.println("closing file: " + fileHandle);
}

static void copy(int fileHandleSrc, int fileHandleDst) throws IOException
{
    System.out.println("copying file " + fileHandleSrc + " to file " +
        fileHandleDst);
    if (Math.random() < 0.5)
        throw new IOException("unable to copy file");
}
}
```

Listing 5-29 presents a Copy application class that simulates the copying of bytes from a source file to a destination file. The try block invokes the `open()` method to open the source file and the `create()` method to create the destination file. Each method returns an integer-based *file handle* that uniquely identifies the file.

Next, this block calls the `copy()` method to perform the copy. After outputting a suitable message, `copy()` invokes the `Math` class's `random()` method (officially discussed in Chapter 7) to return a random number between 0 and 1. When this method returns a value less than 0.5, which simulates a problem (perhaps the disk is full), the `IOException` class is instantiated and this instance is thrown.

The virtual machine locates the catch block that follows the try block and causes its handler to execute, which outputs a message. Then, the code in the finally block that follows the catch block is allowed to execute. Its purpose is to close both files by invoking the `close()` method on the passed file handle.

Compile this source code (`javac Copy.java`) and run the application with two arbitrary arguments (`java Copy x.txt x.bak`). You should observe the following output when there is no problem:

```
copying file 1 to file 2
closing file: 1
closing file: 2
```

When something goes wrong, you should observe the following output:

```
copying file 1 to file 2
I/O error: unable to copy file
closing file: 1
closing file: 2
```

Whether or not an I/O error occurs, notice that the finally block is the final code to execute. The finally block executes even though the catch block ends with a return statement.

This example illustrates finally block execution after a thrown exception is handled. However, you might want to perform cleanup before the exception is handled. Listing 5-30 presents a variation of the Copy application that demonstrates this alternative.

**Listing 5-30. Cleaning Up by Closing Files Before Handling a Thrown Exception**

```
import java.io.IOException;

public class Copy
{
    public static void main(String[] args) throws IOException
    {
        if (args.length != 2)
        {
            System.err.println("usage: java Copy srcFile dstFile");
            return;
        }
    }
}
```

```

int fileHandleSrc = 0;
int fileHandleDst = 1;
try
{
    fileHandleSrc = open(args[0]);
    fileHandleDst = create(args[1]);
    copy(fileHandleSrc, fileHandleDst);
}
finally
{
    close(fileHandleSrc);
    close(fileHandleDst);
}
}

static int open(String filename)
{
    return 1; // Assume that filename is mapped to integer.
}

static int create(String filename)
{
    return 2; // Assume that filename is mapped to integer.
}

static void close(int fileHandle)
{
    System.out.println("closing file: " + fileHandle);
}

static void copy(int fileHandleSrc, int fileHandleDst) throws IOException
{
    System.out.println("copying file " + fileHandleSrc + " to file " +
        fileHandleDst);
    if (Math.random() < 0.5)
        throw new IOException("unable to copy file");
}
}

```

Listing 5-30 is nearly identical to Listing 5-29. The only difference is the throws clause appended to the main() method header and the removal of the catch block. When IOException is thrown, the finally block executes before execution leaves the main() method. This time, Java's default exception handler executes printStackTrace() and you observe output similar to the following:

```

copying file 1 to file 2
closing file: 1
closing file: 2
Exception in thread "main" java.io.IOException: unable to copy file
    at Copy.copy(Copy.java:48)
    at Copy.main(Copy.java:19)

```

## EXERCISES

The following exercises are designed to test your understanding of Chapter 5's content.

1. What is a nested class?
2. Identify the four kinds of nested classes.
3. Which nested classes are also known as inner classes?
4. True or false: A static member class has an enclosing instance.
5. How do you instantiate a nonstatic member class from beyond its enclosing class?
6. When is it necessary to declare local variables and parameters `final`?
7. True or false: An interface can be declared within a class or within another interface.
8. Define package.
9. How do you ensure that package names are unique?
10. What is a package statement?
11. True or false: You can specify multiple package statements in a source file.
12. What is an import statement?
13. How do you indicate that you want to import multiple types via a single import statement?
14. During a runtime search, what happens when the virtual machine cannot find a classfile?
15. How do you specify the user classpath to the virtual machine?
16. Define constant interface.
17. Why are constant interfaces used?
18. Why are constant interfaces bad?
19. What is a static import statement?
20. How do you specify a static import statement?
21. What is an exception?
22. In what ways are objects superior to error codes for representing exceptions?
23. What is a throwable?
24. What does the `getCause()` method return?
25. What is the difference between `Exception` and `Error`?
26. What is a checked exception?
27. What is a runtime exception?
28. Under what circumstance would you introduce your own exception class?
29. True or false: You use a `throw` statement to identify exceptions that are thrown from a method by appending this statement to a method's header.
30. What is the purpose of a `try` statement, and what is the purpose of a `catch` block?
31. What is the purpose of a `finally` block?



32. A 2D graphics package supports two-dimensional drawing and transformations (rotation, scaling, translation, etc.). These transformations require a 3-by-3 *matrix* (a table). Declare a G2D class that encloses a private `Matrix` nonstatic member class. Instantiate `Matrix` within G2D's noargument constructor, and initialize the `Matrix` instance to the *identity matrix* (a matrix where all entries are 0 except for those on the upper-left to lower-right diagonal, which are 1).
  33. Extend the logging package to support a null device in which messages are thrown away.
  34. Modify the logging package so that `Logger`'s `connect()` method throws `CannotConnectException` when it cannot connect to its logging destination, and the other two methods each throw `NotConnectedException` when `connect()` was not called or when it threw `CannotConnectException`.
  35. Modify `TestLogger` to respond appropriately to thrown `CannotConnectException` and `NotConnectedException` objects.
- 

## Summary

Classes that are declared outside of any class are known as top-level classes. Java also supports nested classes, which are classes that are declared as members of other classes or scopes.

There are four kinds of nested classes: static member classes, nonstatic member classes, anonymous classes, and local classes. The latter three categories are known as inner classes.

Java supports the partitioning of top-level types into multiple namespaces, to better organize these types and to also prevent name conflicts. Java uses packages to accomplish these tasks.

The package statement identifies the package in which a source file's types are located. The import statement imports types from a package by telling the compiler where to look for unqualified type names during compilation.

An exception is a divergence from an application's normal behavior. Although it can be represented by an error code or object, Java uses objects because error codes are meaningless and cannot contain information about what led to the exception.

Java provides a hierarchy of classes that represent different kinds of exceptions. These classes are rooted in `Throwable`. Moving down the throwable hierarchy, you encounter the `Exception` and `Error` classes, which represent nonerror exceptions and errors.

`Exception` and its subclasses, except for `RuntimeException` (and its subclasses), describe checked exceptions. They are checked because you must check the code to ensure that an exception is handled where thrown or identified as being handled elsewhere.

`RuntimeException` and its subclasses describe unchecked exceptions. You don't have to handle these exceptions because they represent coding mistakes (fix the mistakes). Although the names of their classes can appear in throws clauses, doing so adds clutter.

The throw statement throws an exception to the virtual machine, which searches for an appropriate handler. When the exception is checked, its name must appear in the method's throws clause, unless the name of the exception's superclass is listed in this clause.

A method handles one or more exceptions by specifying a try statement and appropriate catch blocks. A finally block can be included to execute cleanup code whether an exception is thrown or not, and before a thrown exception leaves the method.

Chapter 6 continues to explore the Java language by focusing on assertions, annotations, generics, and enums.

# Mastering Advanced Language Features, Part 2

In Chapters 2 through 4, I laid a foundation for learning the Java language, and in Chapter 5, I built onto this foundation by introducing some of Java's more advanced language features. In this chapter, I will continue to cover advanced language features by focusing on those features related to assertions, annotations, generics, and enums.

## Mastering Assertions

Writing source code is not an easy task. All too often, bugs are introduced into the code. When a bug is not discovered before compiling the source code, it makes it into runtime code, which will probably fail unexpectedly (or show no sign of failure but give wrong output). At this point, the cause of failure can be very difficult to determine.

Developers often make assumptions about application correctness, and some developers think that specifying comments that state their beliefs about what they think is true at the comment locations is sufficient for determining correctness. However, comments are useless for preventing bugs because the compiler ignores them.

Many languages address this problem by providing a language feature called *assertions* that lets the developer codify assumptions about application correctness. When the application runs, and if an assertion fails, the application terminates with a message that helps the developer diagnose the failure's cause. (You might think of assertions as comments that the compiler understands.)

**Note** In his “Assert Statements Shine Light Into Dark Corners” blog post ([www.drdobbs.com/cpp/assert-statements-shine-light-into-dark/240012746](http://www.drdobbs.com/cpp/assert-statements-shine-light-into-dark/240012746)), computer scientist Andrew Koenig mentions that assertions are used to detect invariant failures, where an *invariant* is something in your code that should not change. For example, you might want to verify the expectation that a list of data items is sorted (an invariant) before attempting to search that list via the Binary Search algorithm, which requires that the list be sorted. You would use an assertion to learn whether the invariant holds or not.

In this section, I will introduce you to Java’s assertions language feature. After defining this term, I will show you how to declare assertions and then look at how to use and avoid assertions. Finally, you will learn how to selectively enable and disable assertions via the `javac` compiler tool’s command-line arguments.

## Declaring Assertions

An *assertion* is a statement that lets you express an assumption of program correctness via a Boolean expression. If this expression evaluates to true, execution continues with the next statement. Otherwise, an error that identifies the cause of failure is thrown.

There are two forms of the assertion statement, with each form beginning with reserved word `assert`.

```
assert expression1 ;
assert expression1 : expression2 ;
```

In both forms of this statement, *expression1* is the Boolean expression. In the second form, *expression2* is any expression that returns a value. It cannot be a call to a method whose return type is `void`.

When *expression1* evaluates to false, this statement instantiates class `java.lang.AssertionError`. The first statement form calls this class’s noargument constructor, which doesn’t associate a message identifying failure details with the `AssertionError` instance. The second form calls an `AssertionError` constructor whose type matches the type of *expression2*’s value. This value is passed to the constructor and its string representation is used as the error’s detail message.

When the error is thrown, the name of the source file and the number of the line from where the error was thrown are output to the console as part of the thrown error’s stack trace. In many situations, this information is sufficient for identifying what led to the failure, and the first form of the assertion statement should be used.

Listing 6-1 demonstrates the first form of the assertion statement.

### Listing 6-1. Throwing an Assertion Error without a Detail Message

```
public class AssertionDemo
{
    public static void main(String[] args)
    {
        int x = 1;
        assert x == 0;
    }
}
```

When assertions are enabled (I will discuss this task later), running the previous application results in the following output:

```
Exception in thread "main" java.lang.AssertionError
    at AssertionDemo.main(AssertionDemo.java:6)
```

In other situations, more information is needed to help diagnose the cause of failure. For example, suppose *expression1* compares variables *x* and *y*, and throws an error when *x*'s value exceeds *y*'s value. Because this should never happen, you would probably use the second statement form to output these values so you could diagnose the problem.

Listing 6-2 demonstrates the second form of the assertion statement.

*Listing 6-2. Throwing an Assertion Error with a Detail Message*

```
public class AssertionDemo
{
    public static void main(String[] args)
    {
        int x = 1;
        assert x == 0: x;
    }
}
```

Once again, it is assumed that assertions are enabled. Running the previous application results in the following output:

```
Exception in thread "main" java.lang.AssertionError: 1
    at AssertionDemo.main(AssertionDemo.java:6)
```

The value in *x* is appended to the end of the first output line, which is somewhat cryptic. To make this output more meaningful, you might want to specify an expression that also includes the variable's name: `assert x == 0: "x = " + x;`, for example.

## Using Assertions

There are many situations where assertions should be used. These situations organize into internal invariant, control-flow invariant, and design-by-contract categories. An *invariant* is something in your code that should not change.

### Internal Invariants

An *internal invariant* is expression-oriented behavior that is not expected to change. For example, Listing 6-3 introduces an internal invariant by way of chained if-else statements that output the state of water based on its temperature.

*Listing 6-3. Discovering That an Internal Invariant Can Vary*

```

public class IIDemo
{
    public static void main(String[] args)
    {
        double temperature = 50.0; // Celsius
        if (temperature < 0.0)
            System.out.println("water has solidified");
        else
            if (temperature >= 100.0)
                System.out.println("water is boiling into a gas");
            else
                {
                    // temperature > 0.0 and temperature < 100.0
                    assert(temperature > 0.0 && temperature < 100.0): temperature;
                    System.out.println("water is remaining in its liquid state");
                }
    }
}

```

A developer might specify only a comment stating an assumption as to what expression causes the final else to be reached. Because the comment might not be enough to detect the lurking `< 0.0` expression bug (water is also solid at zero degrees), an assertion statement is necessary.

Another example of an internal invariant concerns a switch statement with no default case. The default case is avoided because the developer believes that all paths have been covered. However, this is not always true, as Listing 6-4 demonstrates.

*Listing 6-4. Another Buggy Internal Invariant*

```

public class IIDemo
{
    final static int NORTH = 0;
    final static int SOUTH = 1;
    final static int EAST = 2;
    final static int WEST = 3;

    public static void main(String[] args)
    {
        int direction = (int) (Math.random() * 5);
        switch (direction)
        {
            case NORTH: System.out.println("travelling north"); break;
            case SOUTH: System.out.println("travelling south"); break;
            case EAST : System.out.println("travelling east"); break;
            case WEST : System.out.println("travelling west"); break;
            default   : assert false;
        }
    }
}

```

Listing 6-4 assumes that the expression tested by `switch` will only evaluate to one of four integer constants. However, `(int) (Math.random() * 5)` can also return 4, causing the default case to execute `assert false;`, which always throws `AssertionError`. (You might have to run this application a few times to see the assertion error, but first you need to learn how to enable assertions, which I will discuss later in this chapter.)

**Tip** When assertions are disabled, `assert false;` doesn't execute and the bug goes undetected. To always detect this bug, replace `assert false;` with `throw new AssertionError(direction);`.

## Control-Flow Invariants

A *control-flow invariant* is a flow of control that is not expected to change. For example, Listing 6-4 uses an assertion to test an assumption that `switch`'s default case will not execute. Listing 6-5, which fixes Listing 6-4's bug, provides another example.

*Listing 6-5. A Buggy Control-Flow Invariant*

```
public class CFDemo
{
    final static int NORTH = 0;
    final static int SOUTH = 1;
    final static int EAST = 2;
    final static int WEST = 3;

    public static void main(String[] args)
    {
        int direction = (int) (Math.random() * 4);
        switch (direction)
        {
            case NORTH: System.out.println("travelling north"); break;
            case SOUTH: System.out.println("travelling south"); break;
            case EAST : System.out.println("travelling east"); break;
            case WEST : System.out.println("travelling west");
            default : assert false;
        }
    }
}
```

Because the original bug has been fixed, the default case should never be reached. However, the omission of a `break` statement that terminates `case WEST` causes execution to reach the default case. This control-flow invariant has been broken. (Again, you might have to run this application a few times to see the assertion error, but first you need to learn how to enable assertions, which I will discuss later in this chapter.)

**Caution** Be careful when using an assertion statement to detect code that should never be executed. If the assertion statement cannot be reached according to the rules set forth in *The Java Language Specification, Third Edition*, by James Gosling, Bill Joy, Guy Steele, and Gilad Bracha (Addison-Wesley, 2005; ISBN: 0321246780; also available at <http://docs.oracle.com/javase/specs/>), the compiler will report an error. For example, `for (;;) ; assert false;` causes the compiler to report an error because the infinite for loop prevents the assertion statement from executing.

## Design-by-Contract

*Design-by-Contract* ([http://en.wikipedia.org/wiki/Design\\_by\\_contract](http://en.wikipedia.org/wiki/Design_by_contract)) is a way to design software based on preconditions, postconditions, and class invariants. Assertion statements support an informal design-by-contract style of development.

### Preconditions

A *precondition* is something that must be true when a method is called. Assertion statements are often used to satisfy a helper method's preconditions by checking that its arguments are legal. Listing 6-6 provides an example.

*Listing 6-6. Verifying a Precondition*

```
public class Lotto649
{
    public static void main(String[] args)
    {
        // Lotto 649 requires that six unique numbers be chosen.
        int[] selectedNumbers = new int[6];
        // Assign a unique random number from 1 to 49 (inclusive) to each slot
        // in the selectedNumbers array.
        for (int slot = 0; slot < selectedNumbers.length; slot++)
        {
            int num;
            // Obtain a random number from 1 to 49. That number becomes the
            // selected number if it has not previously been chosen.
            try_again:
            do
            {
                num = rnd(49) + 1;
                for (int i = 0; i < slot; i++)
                    if (selectedNumbers[i] == num)
                        continue try_again;
                break;
            }
            while (true);
            // Assign selected number to appropriate slot.
            selectedNumbers[slot] = num;
        }
    }
}
```

```

// Sort all selected numbers into ascending order and then print these
// numbers.
sort(selectedNumbers);
for (int i = 0; i < selectedNumbers.length; i++)
    System.out.print(selectedNumbers[i] + " ");
}

static int rnd(int limit)
{
    // This method returns a random number (actually, a pseudorandom number)
    // ranging from 0 through limit - 1 (inclusive).
    assert limit > 1: "limit = " + limit;
    return (int) (Math.random() * limit);
}

static void sort(int[] x)
{
    // This method sorts the integers in the passed array into ascending
    // order.
    for (int pass = 0; pass < x.length - 1; pass++)
        for (int i = x.length - 1; i > pass; i--)
            if (x[i] < x[pass])
                {
                    int temp = x[i];
                    x[i] = x[pass];
                    x[pass] = temp;
                }
}
}

```

Listing 6-6's application simulates Lotto 6/49, one of Canada's national lottery games. The `rnd()` helper method returns a randomly chosen integer between 0 and `limit - 1`. An assertion statement verifies the precondition that `limit`'s value must be 2 or higher.

**Note** The `sort()` helper method *sorts* (orders) the `selectedNumbers` array's integers into ascending order by implementing an *algorithm* (a recipe for accomplishing some task) called Bubble Sort.

Bubble Sort works by making multiple passes over the array. During each pass, various comparisons and swaps ensure that the next smallest element value "bubbles" toward the top of the array, which would be the element at index 0.

Bubble Sort is not efficient, but is more than adequate for sorting a six-element array. Although I could have used one of the efficient `sort()` methods located in the `java.util` package's `Arrays` class (for example, `Arrays.sort(selectedNumbers)`; accomplishes the same objective as Listing 6-6's `sort(selectedNumbers)`; method call, but does so more efficiently), I chose to use Bubble Sort because I prefer to wait until Chapter 9 before getting into the `Arrays` class.



## Postconditions

A *postcondition* is something that must be true after a method successfully completes. Assertion statements are often used to satisfy a helper method's postconditions by checking that its result is legal. Listing 6-7 provides an example.

*Listing 6-7. Verifying a Postcondition in Addition to Preconditions*

```
public class MergeArrays
{
    public static void main(String[] args)
    {
        int[] x = { 1, 2, 3, 4, 5 };
        int[] y = { 1, 2, 7, 9 };
        int[] result = merge(x, y);
        for (int i = 0; i < result.length; i++)
            System.out.println(result[i]);
    }

    static int[] merge(int[] a, int[] b)
    {
        if (a == null)
            throw new NullPointerException("a is null");
        if (b == null)
            throw new NullPointerException("b is null");
        int[] result = new int[a.length + b.length];
        // Precondition
        assert result.length == a.length + b.length: "length mismatch";
        for (int i = 0; i < a.length; i++)
            result[i] = a[i];
        for (int i = 0; i < b.length; i++)
            result[a.length + i - 1] = b[i];
        // Postcondition
        assert containsAll(result, a, b): "value missing from array";
        return result;
    }

    static boolean containsAll(int[] result, int[] a, int[] b)
    {
        for (int i = 0; i < a.length; i++)
            if (!contains(result, a[i]))
                return false;
        for (int i = 0; i < b.length; i++)
            if (!contains(result, b[i]))
                return false;
        return true;
    }
}
```

```

static boolean contains(int[] a, int val)
{
    for (int i = 0; i < a.length; i++)
        if (a[i] == val)
            return true;
    return false;
}
}

```

Listing 6-7 uses an assertion statement to verify the postcondition that all of the values in the two arrays being merged are present in the merged array. The postcondition is not satisfied, however, because this listing contains a bug.

Listing 6-7 also shows preconditions and postconditions being used together. The solitary precondition verifies that the merged array length equals the lengths of the arrays being merged prior to the merge logic.

## Class Invariants

A *class invariant* is a kind of internal invariant that applies to every instance of a class at all times, except when an instance is transitioning from one consistent state to another.

For example, suppose instances of a class contain arrays whose values are sorted in ascending order. You might want to include an `isSorted()` method in the class that returns true when the array is still sorted, and verify that each constructor and method that modifies the array specifies `assert isSorted();` prior to exit, to satisfy the assumption that the array is still sorted when the constructor or method exits.

## Avoiding Assertions

Although there are many situations where assertions should be used, there also are situations where they should be avoided. For example, you should not use assertions to check the arguments that are passed to public methods for the following reasons:

- Checking a public method's arguments is part of the contract that exists between the method and its caller. If you use assertions to check these arguments, and if assertions are disabled, this contract is violated because the arguments will not be checked.
- Assertions also prevent appropriate exceptions from being thrown. For example, when an illegal argument is passed to a public method, it is common to throw `java.lang.IllegalArgumentException` or `java.lang.NullPointerException`. However, `AssertionError` is thrown instead.

You should also avoid using assertions to perform work required by the application to function correctly. This work is often performed as a side effect of the assertion's Boolean expression. When assertions are disabled, the work is not performed.

For example, suppose you have a list of `Employee` objects and a few null references that are also stored in this list, and you want to remove all of the null references. It would not be correct to remove these references via the following assertion statement:

```
assert employees.removeAll(null);
```

Although the assertion statement will not throw `AssertionError` because there is at least one null reference in the `employees` list, the application that depends upon this statement executing will fail when assertions are disabled.

Instead of depending on the former code to remove the null references, you would be better off using code similar to the following:

```
boolean allNullsRemoved = employees.removeAll(null);
assert allNullsRemoved;
```

This time, all null references are removed regardless of whether assertions are enabled or disabled and you can still specify an assertion to verify that nulls were removed.

## Enabling and Disabling Assertions

The compiler records assertions in the classfile. However, assertions are disabled at runtime because they can affect performance. An assertion might call a method that takes awhile to complete, and this would impact the running application's performance.

You must enable the classfile's assertions before you can test assumptions about the behaviors of your classes. Accomplish this task by specifying the `-enableassertions` or `-ea` command-line option when running the `java` application launcher tool.

The `-enableassertions` and `-ea` command-line options let you enable assertions at various granularities based upon one of the following arguments (except for the noargument scenario, you must use a colon to separate the option from its argument):

- *No argument*: Assertions are enabled in all classes except system classes.
- *PackageName...*: Assertions are enabled in the specified package and its subpackages by specifying the package name followed by `...`
- `...`: Assertions are enabled in the unnamed package, which happens to be whatever directory is current.
- *ClassName*: Assertions are enabled in the named class by specifying the class name.

For example, you can enable all assertions except system assertions when running the `MergeArrays` application via `java -ea MergeArrays`. Also, you could enable any assertions that you might add to Chapter 5's logging package by specifying `java -ea:logging TestLogger`.

Assertions can be disabled, and also at various granularities, by specifying either of the `-disableassertions` or `-da` command-line options. These options take the same arguments as `-enableassertions` and `-ea`. For example, `java -ea -da:loneclass mainclass` enables all assertions except for those in `loneclass`. (Think of `loneclass` and `mainclass` as placeholders for the actual classes that you specify.)

The previous options apply to all classloaders (discussed in Chapter 16). Except when taking no arguments, they also apply to system classes. This exception simplifies the enabling of assertion statements in all classes except for system classes, which is often desirable.

To enable system assertions, specify either `-enablesystemassertions` or `-esa`, for example, `java -esa -ea:logging TestLogger`. Specify either `-disablesystemassertions` or `-dsa` to disable system assertions.

## Mastering Annotations

While developing a Java application, you might want to *annotate* (associate *metadata*, which is data that describes other data, with) various application elements. For example, you might want to identify methods that are not fully implemented so that you will not forget to implement them. Java's annotations language feature lets you accomplish this task.

In this section I will introduce you to annotations. After defining this term and presenting three kinds of compiler-supported annotations as examples, I will show you how to declare your own annotation types and use these types to annotate source code. Finally, you will discover how to process your own annotations to accomplish useful tasks.

**Note** Java has always supported ad hoc annotation mechanisms. For example, the `java.lang.Cloneable` interface identifies classes whose instances can be shallowly cloned via `java.lang.Object`'s `clone()` method; the `transient` reserved word marks fields that are to be ignored during serialization; and the `@deprecated` Javadoc tag documents methods that are no longer supported. In contrast, the annotations feature is a standard for annotating code.

## Discovering Annotations

An *annotation* is an instance of an annotation type and associates metadata with an application element. It is expressed in source code by prefixing the type name with the `@` symbol. For example, `@ReadOnly` is an annotation and `ReadOnly` is its type.

**Note** You can use annotations to associate metadata with constructors, fields, local variables, methods, packages, parameters, and types (annotation, class, enum, and interface).

The compiler supports the `Override`, `Deprecated`, and `SuppressWarnings` annotation types. These types are located in the `java.lang` package.

`@Override` annotations are useful for expressing that a subclass method overrides a method in the superclass and doesn't overload that method instead. The following example reveals this annotation being used to prefix the overriding method:

```
@Override
public void draw(int color)
{
    // drawing code
}
```

`@Deprecated` annotations are useful for indicating that the marked application element is *deprecated* (phased out) and should no longer be used. The compiler warns you when a deprecated application element is accessed by nondeprecated code.

In contrast, the `@deprecated` javadoc tag and associated text warns you against using the deprecated item, and tells you what to use instead. The following example demonstrates that `@Deprecated` and `@deprecated` can be used together:

```
/**
 * Allocates a <code>Date</code> object and initializes it so that
 * it represents midnight, local time, at the beginning of the day
 * specified by the <code>year</code>, <code>month</code>, and
 * <code>date</code> arguments.
 *
 * @param year the year minus 1900.
 * @param month the month between 0-11.
 * @param date the day of the month between 1-31.
 * @see java.util.Calendar
 * @deprecated As of JDK version 1.1,
 * replaced by <code>Calendar.set(year + 1900, month, date)</code>
 * or <code>GregorianCalendar(year + 1900, month, date)</code>.
 */
@Deprecated
public Date(int year, int month, int date)
{
    this(year, month, date, 0, 0, 0);
}
```

This example excerpts one of the constructors in Java's `Date` class (located in the `java.util` package). Its Javadoc comment reveals that `Date(int year, int month, int date)` has been deprecated in favor of using the `set()` method in the `Calendar` class (also located in the `java.util` package). (I explore `Date` and `Calendar` in Chapter 16.)

The compiler suppresses warnings when a compilation unit (typically a class or interface) refers to a deprecated class, method, or field. This feature lets you modify legacy APIs without generating deprecation warnings and is demonstrated in Listing 6-8.

**Listing 6-8. Referencing a Deprecated Field from the Same Class Declaration**

```
public class Employee
{
    /**
     * Employee's name
     * @deprecated New version uses firstName and lastName fields.
     */
    @Deprecated
    String name;
    String firstName;
    String lastName;
```

```

public static void main(String[] args)
{
    Employee emp = new Employee();
    emp.name = "John Doe";
}
}

```

Listing 6-8 declares an `Employee` class with a `name` field that has been deprecated. Although `Employee`'s `main()` method refers to `name`, the compiler will suppress a deprecation warning because the deprecation and reference occur in the same class.

Suppose you refactor this listing by introducing a new `UseEmployee` class and moving `Employee`'s `main()` method to this class. Listing 6-9 presents the resulting class structure.

*Listing 6-9. Referencing a Deprecated Field from Another Class Declaration*

```

class Employee
{
    /**
     * Employee's name
     * @deprecated New version uses firstName and lastName fields.
     */
    @Deprecated
    String name;
    String firstName;
    String lastName;
}

public class UseEmployee
{
    public static void main(String[] args)
    {
        Employee emp = new Employee();
        emp.name = "John Doe";
    }
}

```

If you attempt to compile this source code via the `javac` compiler tool, you will discover the following messages:

Note: `UseEmployee.java` uses or overrides a deprecated API.

Note: Recompile with `-Xlint:deprecation` for details.

You will need to specify `-Xlint:deprecation` as one of `javac`'s command-line arguments (as in `javac -Xlint:deprecation UseEmployee.java`) to discover the deprecated item and the code that refers to this item:

```

Employee.java:18: warning: [deprecation] name in Employee has been deprecated
    emp.name = "John Doe";
        ^

```

1 warning

`@SuppressWarnings` annotations are useful for suppressing deprecation or unchecked warnings via a "deprecation" or an "unchecked" argument. (Unchecked warnings occur when mixing code that uses generics with pre-generics legacy code. I will discuss generics and unchecked warnings later in this chapter.)

For example, Listing 6-10 uses `@SuppressWarnings` with a "deprecation" argument to suppress the compiler's deprecation warnings when code in the `UseEmployee` class's `main()` method accesses the `Employee` class's `name` field.

*Listing 6-10. Suppressing the Previous Deprecation Warning*

```
public class UseEmployee
{
    @SuppressWarnings("deprecation")
    public static void main(String[] args)
    {
        Employee emp = new Employee();
        emp.name = "John Doe";
    }
}
```

**Note** As a matter of style, you should always specify `@SuppressWarnings` on the most deeply nested element where it is effective. For example, if you want to suppress a warning in a particular method, you should annotate that method rather than its class.

## Declaring Annotation Types and Annotating Source Code

Before you can annotate source code, you need annotation types that can be instantiated. Java supplies many annotation types in addition to `Override`, `Deprecated`, and `SuppressWarnings`. Java also lets you declare your own types.

You declare an annotation type by specifying the `@` symbol, immediately followed by reserved word `interface`, followed by the type's name, followed by a body. For example, Listing 6-11 uses `@interface` to declare an annotation type named `Stub`.

*Listing 6-11. Declaring the Stub Annotation Type*

```
public @interface Stub
{
}
```

Instances of annotation types that supply no data apart from a name—their bodies are empty—are known as *marker annotations* because they mark application elements for some purpose. As Listing 6-12 reveals, `@Stub` is used to mark empty methods (stubs).

**Listing 6-12. Annotating a Stubbed-Out Method**

```
public class Deck // Describes a deck of cards.
{
    @Stub
    public void shuffle()
    {
        // This method is empty and will presumably be filled in with appropriate
        // code at some later date.
    }
}
```

Listing 6-12's Deck class declares an empty shuffle() method. This fact is indicated by instantiating Stub and prefixing shuffle()'s method header with the resulting @Stub annotation.

**Note** Although marker interfaces (introduced in Chapter 4) appear to have been replaced by marker annotations, this is not the case, because marker interfaces have advantages over marker annotations. One advantage is that a marker interface specifies a type that is implemented by a marked class, which lets you catch problems at compile time. For example, when a class doesn't implement the Cloneable interface, its instances cannot be shallowly cloned via Object's clone() method. If Cloneable had been implemented as a marker annotation, this problem would not be detected until runtime.

Although marker annotations are useful (@Override and @Deprecated are good examples), you will typically want to enhance an annotation type so that you can store metadata via its instances. You accomplish this task by adding elements to the type.

An *element* is a method header that appears in the annotation type's body. It cannot have parameters or a throws clause, and its return type must be a primitive type (such as int), java.lang.String, java.lang.Class, an enum (discussed later in this chapter), an annotation type, or an array of the preceding types. However, it can have a default value.

Listing 6-13 adds three elements to Stub.

**Listing 6-13. Adding Three Elements to the Stub Annotation Type**

```
public @interface Stub
{
    int id(); // A semicolon must terminate an element declaration.
    String dueDate();
    String developer() default "unassigned";
}
```

The id() element specifies a 32-bit integer that identifies the stub. The dueDate() element specifies a String-based date that identifies when the method stub is to be implemented. Finally, developer() specifies the String-based name of the developer responsible for coding the method stub.



Unlike `id()` and `dueDate()`, `developer()` is declared with a default value, "unassigned". When you instantiate `Stub` and don't assign a value to `developer()` in that instance, as is the case with Listing 6-14, this default value is assigned to `developer()`.

*Listing 6-14. Initializing a Stub Instance's Elements*

```
public class Deck
{
    @Stub
    (
        id = 1,
        dueDate = "12/21/2012"
    )
    public void shuffle()
    {
    }
}
```

Listing 6-14 reveals one `@Stub` annotation that initializes its `id()` element to 1 and its `dueDate()` element to "12/21/2012". Each element name doesn't have a trailing `()`, and the comma-separated list of two element initializers appears between `(` and `)`.

Suppose you decide to replace `Stub`'s `id()`, `dueDate()`, and `developer()` elements with a single `String value()` element whose string specifies comma-separated ID, due date, and developer name values. Listing 6-15 shows you two ways to initialize `value`.

*Listing 6-15. Initializing Each Stub Instance's value() Element*

```
public class Deck
{
    @Stub(value = "1,12/21/2012,unassigned")
    public void shuffle()
    {
    }

    @Stub("2,12/21/2012,unassigned")
    public Card[] deal(int ncards)
    {
        return null;
    }
}
```

Listing 6-15 reveals special treatment for the `value()` element. When it's an annotation type's only element, you can omit `value()`'s name and `=` from the initializer. I used this fact to specify `@SuppressWarnings("deprecation")` in Listing 6-10.

## Using Meta-Annotations in Annotation Type Declarations

Each of the `Override`, `Deprecated`, and `SuppressWarnings` annotation types is itself annotated with *meta-annotations* (annotations that annotate annotation types). For example, Listing 6-16 shows you that the `SuppressWarnings` annotation type is annotated with two meta-annotations.

*Listing 6-16. The annotated SuppressWarnings Type Declaration*

```
@Target(value={TYPE, FIELD, METHOD, PARAMETER, CONSTRUCTOR, LOCAL_VARIABLE})
@Retention(value=SOURCE)
public @interface SuppressWarnings
```

The `Target` annotation type, which is located in the `java.lang.annotation` package, identifies the kinds of application elements to which an annotation type applies. `@Target` indicates that `@SuppressWarnings` annotations can be used to annotate types, fields, methods, parameters, constructors, and local variables.

Each of `TYPE`, `FIELD`, `METHOD`, `PARAMETER`, `CONSTRUCTOR`, and `LOCAL_VARIABLE` is a member of the `ElementType` enum, which is also located in the `java.lang.annotation` package. (I discuss enums later in this chapter.)

The `{` and `}` characters surrounding the comma-separated list of values assigned to `Target`'s `value()` element signify an array—`value()`'s return type is `String[]`. Although these braces are necessary (unless the array consists of one item), `value=` could be omitted when initializing `@Target` because `Target` declares only a `value()` element.

The `Retention` annotation type, which is located in the `java.lang.annotation` package, identifies the retention (also known as lifetime) of an annotation type's annotations. `@Retention` indicates that `@SuppressWarnings` annotations have a lifetime that is limited to source code—they don't exist after compilation.

`SOURCE` is one of the members of the `RetentionPolicy` enum (located in the `java.lang.annotation` package). The other members are `CLASS` and `RUNTIME`. These three members specify the following retention policies:

- **CLASS:** The compiler records annotations in the classfile, but the virtual machine doesn't retain them (to save memory space). This policy is the default.
- **RUNTIME:** The compiler records annotations in the classfile, and the virtual machine retains them so that they can be read via the Reflection API (see Chapter 8) at runtime.
- **SOURCE:** The compiler discards annotations after using them.

There are two problems with the `Stub` annotation type shown in Listings 6-11 and 6-13. First, the lack of an `@Target` meta-annotation means that you can annotate any application element `@Stub`. However, this annotation only makes sense when applied to methods and constructors. Check out Listing 6-17.

*Listing 6-17. Annotating Undesirable Application Elements*

```
@Stub("1,12/21/2012,unassigned")
public class Deck
{
    @Stub("2,12/21/2012,unassigned")
    private Card[] cardsRemaining = new Card[52];
```

```

@Stub("3,12/21/2012,unassigned")
public Deck()
{
}

@Stub("4,12/21/2012,unassigned")
public void shuffle()
{
}

@Stub("5,12/21/2012,unassigned")
public Card[] deal(@Stub("5,12/21/2012,unassigned") int ncards)
{
    return null;
}
}

```

Listing 6-17 uses `@Stub` to annotate the `Deck` class, the `cardsRemaining` field, and the `ncards` parameter as well as annotating the constructor and the two methods. The first three application elements are inappropriate to annotate because they are not stubs.

You can fix this problem by prefixing the `Stub` annotation type declaration with `@Target({ElementType.METHOD, ElementType.CONSTRUCTOR})` so that `Stub` only applies to methods and constructors. After doing this, the `javac` compiler tool will output the following error messages when you attempt to compile Listing 6-17:

```

Deck.java:1: error: annotation type not applicable to this kind of declaration
@Stub("1,12/21/2012,unassigned")
^
Deck.java:4: error: annotation type not applicable to this kind of declaration
    @Stub("2,12/21/2012,unassigned")
    ^
Deck.java:18: error: annotation type not applicable to this kind of declaration
    public Card[] deal(@Stub("5,12/21/2012,unassigned") int ncards)
                       ^
3 errors

```

The second problem is that the default `CLASS` retention policy makes it impossible to process `@Stub` annotations at runtime. You can fix this problem by prefixing the `Stub` type declaration with `@Retention(RetentionPolicy.RUNTIME)`.

Listing 6-18 presents the `Stub` annotation type with the desired `@Target` and `@Retention` meta-annotations.

*Listing 6-18. A Revamped Stub Annotation Type*

```

import java.lang.annotation.ElementType;
import java.lang.annotation.Retention;
import java.lang.annotation.RetentionPolicy;
import java.lang.annotation.Target;

```

```
@Target({ElementType.METHOD, ElementType.CONSTRUCTOR})
@Retention(RetentionPolicy.RUNTIME)
public @interface Stub
{
    String value();
}
```

**Note** Java also provides Documented and Inherited meta-annotation types in the `java.lang.annotation` package. Instances of `@Documented`-annotated annotation types are to be documented by javadoc and similar tools, whereas instances of `@Inherited`-annotated annotation types are automatically inherited. According to Inherited's Java documentation, if "the user queries the annotation type on a class declaration, and the class declaration has no annotation for this type, then the class's superclass will automatically be queried for the annotation type. This process will be repeated until an annotation for this type is found, or the top of the class hierarchy (`Object`) is reached. If no superclass has an annotation for this type, then the query will indicate that the class in question has no such annotation."

## Processing Annotations

It's not enough to declare an annotation type and use that type to annotate source code. Unless you do something specific with those annotations, they remain dormant. One way to accomplish something specific is to write an application that processes the annotations. Listing 6-19's `StubFinder` application does just that.

### Listing 6-19. The `StubFinder` Application

```
import java.lang.reflect.Method;

public class StubFinder
{
    public static void main(String[] args) throws Exception
    {
        if (args.length != 1)
        {
            System.err.println("usage: java StubFinder classfile");
            return;
        }
        Method[] methods = Class.forName(args[0]).getMethods();
        for (int i = 0; i < methods.length; i++)
            if (methods[i].isAnnotationPresent(Stub.class))
            {
                Stub stub = methods[i].getAnnotation(Stub.class);
                String[] components = stub.value().split(",");
                System.out.println("Stub ID = " + components[0]);
                System.out.println("Stub Date = " + components[1]);
            }
    }
}
```

```

        System.out.println("Stub Developer = " + components[2]);
        System.out.println();
    }
}

```

StubFinder loads a classfile whose name is specified as a command-line argument and outputs the metadata associated with each @Stub annotation that precedes each public method header. These annotations are instances of Listing 6-18's Stub annotation type.

StubFinder next uses a special class named Class and its `forName()` class method to load a classfile. Class also provides a `getMethods()` method that returns an array of `java.lang.reflect.Method` objects (see Chapter 8) describing the loaded class's public methods.

For each loop iteration, a Method object's `isAnnotationPresent()` method is called to determine if the method is annotated with the annotation described by the Stub class (referred to as `Stub.class`).

If `isAnnotationPresent()` returns true, Method's `getAnnotation()` method is called to return the annotation Stub instance. This instance's `value()` method is called to retrieve the string stored in the annotation.

Next, String's `split()` method is called to split the string's comma-separated list of ID, date, and developer values into an array of String objects. Each object is then output along with descriptive text. (You will be formally introduced to `split()` in Chapter 7.)

Class's `forName()` method is capable of throwing various exceptions that must be handled or explicitly declared as part of a method's header. For simplicity, I chose to append a `throws Exception` clause to the `main()` method's header.

**Caution** There are two problems with `throws Exception`. First, it is often better to handle the exception and present a suitable error message than to “pass the buck” by throwing it out of `main()`. Second, `Exception` is generic; it hides the names of the kinds of exceptions that are thrown. However, I find it convenient to specify `throws Exception` in a throwaway utility.

After compiling StubFinder (`javac StubFinder.java`), Stub (`javac Stub.java`), and Listing 6-15's Deck class (`javac Deck.java`), run StubFinder with Deck as its single command-line argument (`java StubFinder Deck`). You will observe the following output:

```

Stub ID = 1
Stub Date = 12/21/2012
Stub Developer = unassigned

Stub ID = 2
Stub Date = 12/21/2012
Stub Developer = unassigned

```

## Mastering Generics

Java 5 introduced *generics*, language features for declaring and using type-agnostic classes and interfaces. While working with Java's Collections Framework (which I discuss in Chapter 9), these features help you avoid `java.lang.ClassCastException`s.

**Note** Although the main use for generics is the Collections Framework, the standard class library also contains *generified* (retrofitted to make use of generics) classes that have nothing to do with this framework: `java.lang.Class`, `java.lang.ThreadLocal`, and `java.lang.ref.WeakReference` are three examples.

In this section, I will introduce you to generics. You will first learn how generics promote type safety in the context of the Collections Framework classes, and then you will explore generics in the contexts of generic types and generic methods. Finally, you will learn about generics in the context of arrays.

### Collections and the Need for Type Safety

Java's Collections Framework makes it possible to store objects in various kinds of containers (known as collections) and later retrieve those objects. For example, you can store objects in a list, a set, or a map. You can then retrieve a single object, or iterate over the collection and retrieve all objects.

Before Java 5 overhauled the Collections Framework to take advantage of generics, there was no way to prevent a collection from containing objects of mixed types. The compiler didn't check an object's type to see if it was suitable before it was added to a collection, and this lack of static type checking led to `ClassCastException`s.

Listing 6-20 demonstrates how easy it is to generate a `ClassCastException`.

*Listing 6-20. Lack of Type Safety Leading to a `ClassCastException` at Runtime*

```
import java.util.ArrayList;
import java.util.Iterator;
import java.util.List;

class Employee
{
    private String name;

    Employee(String name)
    {
        this.name = name;
    }
}
```

```

String getName()
{
    return name;
}
}

public class TypeSafety
{
    public static void main(String[] args)
    {
        List employees = new ArrayList();
        employees.add(new Employee("John Doe"));
        employees.add(new Employee("Jane Smith"));
        employees.add("Jack Frost");
        Iterator iter = employees.iterator();
        while (iter.hasNext())
        {
            Employee emp = (Employee) iter.next();
            System.out.println(emp.getName());
        }
    }
}

```

Listing 6-20's `main()` method first instantiates `java.util.ArrayList` and then uses this list collection object's reference to add a pair of `Employee` objects to the list. It then adds a `String` object, which violates the implied contract that `ArrayList` is supposed to store only `Employee` objects.

`main()` next obtains a `java.util.Iterator` instance for iterating over the list of `Employees`. As long as `Iterator`'s `hasNext()` method returns true, its `next()` method is called to return an object stored in the array list.

The `Object` that `next()` returns must be downcast to `Employee` so that the `Employee` object's `getName()` method can be called to return the employee's name. The string that this method returns is then output to the standard output device via `System.out.println()`.

The `(Employee)` cast checks the type of each object returned by `next()` to make sure that it is an `Employee`. Although this is true of the first two objects, it's not true of the third object. The attempt to cast "Jack Frost" to `Employee` results in a `ClassCastException`.

The `ClassCastException` occurs because of an assumption that a list is *homogenous*. In other words, a list stores only objects of a single type or a family of related types. In reality, the list is *heterogeneous* in that it can store any `Object`.

Listing 6-21's generics-based homogenous list avoids `ClassCastException`.

**Listing 6-21. Lack of Type Safety Leading to a Compiler Error**

```

import java.util.ArrayList;
import java.util.Iterator;
import java.util.List;

```

```

class Employee
{
    private String name;

    Employee(String name)
    {
        this.name = name;
    }

    String getName()
    {
        return name;
    }
}

public class TypeSafety
{
    public static void main(String[] args)
    {
        List<Employee> employees = new ArrayList<Employee>();
        employees.add(new Employee("John Doe"));
        employees.add(new Employee("Jane Smith"));
        employees.add("Jack Frost");
        Iterator<Employee> iter = employees.iterator();
        while (iter.hasNext())
        {
            Employee emp = iter.next();
            System.out.println(emp.getName());
        }
    }
}

```

Listing 6-21's refactored `main()` method illustrates the central feature of generics, which is the *parameterized type* (a class or interface name followed by an angle-bracket delimited type list identifying what kinds of objects are legal in that context).

For example, `java.util.List<Employee>` indicates only `Employee` objects can be stored in the `List`. As shown, the `<Employee>` designation must be repeated with `ArrayList`, as in `ArrayList<Employee>`, which is the collection implementation that stores the `Employees`.

Also, `Iterator<Employee>` indicates that `iterator()` returns an `Iterator` whose `next()` method returns only `Employee` objects. It's not necessary to cast `iter.next()`'s returned value to `Employee` because the compiler inserts the cast on your behalf.

If you attempt to compile this listing, the compiler will report an error when it encounters `employees.add("Jack Frost");`. The error message will tell you that the compiler cannot find an `add(java.lang.String)` method in the `java.util.List<Employee>` interface.

Unlike in the pre-generics `List` interface, which declares an `add(Object)` method, the generified `List` interface's `add()` method parameter reflects the interface's parameterized type name. For example, `List<Employee>` implies `add(Employee)`.



Listing 6-20 reveals that the unsafe code causing the `ClassCastException` (`employees.add("Jack Frost");`) and the code that triggers the exception (`((Employee) iter.next())`) are quite close. However, they are often farther apart in larger applications.

Rather than having to deal with angry clients while hunting down the unsafe code that ultimately led to the `ClassCastException`, you can rely on the compiler saving you this frustration and effort by reporting an error when it detects this code during compilation. ***Detecting type safety violations at compile time is the main benefit of using generics.***

## Generic Types

A *generic type* is a class or interface that introduces a family of parameterized types by declaring a *formal type parameter list* (a comma-separated list of *type parameter* names between angle brackets). This syntax is expressed as follows:

```
class identifier<formal_type_parameter_list> {}
interface identifier<formal_type_parameter_list> {}
```

For example, `List<E>` is a generic type, where `List` is an interface and type parameter `E` identifies the list's element type. Similarly, `Map<K, V>` is a generic type, where `Map` is an interface and type parameters `K` and `V` identify the map's key and value types.

**Note** When declaring a generic type, it's conventional to specify single uppercase letters as type parameter names. Furthermore, these names should be meaningful. For example, `E` indicates element, `T` indicates type, `K` indicates key, and `V` indicates value. If possible, you should avoid choosing a type parameter name that is meaningless where it is used. For example, `List<E>` means list of elements, but what does `List<S>` mean?

Parameterized types are instances of generic types. Each parameterized type replaces the generic type's type parameters with type names. For example, `List<Employee>` (List of Employee) and `List<String>` (List of String) are examples of parameterized types based on `List<E>`. Similarly, `Map<String, Employee>` is an example of a parameterized type based on `Map<K, V>`.

The type name that replaces a type parameter is known as an *actual type argument*. Five kinds of actual type arguments are supported by generics:

- **Concrete type:** The name of a class or interface is passed to the type parameter. For example, `List<Employee> employees;` specifies that the list elements are `Employee` instances.
- **Concrete parameterized type:** The name of a parameterized type is passed to the type parameter. For example, `List<List<String>> nameLists;` specifies that the list elements are lists of strings.
- **Array type:** An array is passed to the type parameter. For example, `List<String[]> countries;` specifies that the list elements are arrays of Strings, possibly city names.

- *Type parameter*: A type parameter is passed to the type parameter. For example, given class declaration `class X<E> { List<E> queue; }`, X's type parameter E is passed to List's type parameter E.
- *Wildcard*: The `?` is passed to the type parameter. For example, `List<?> list;` specifies that the list elements are unknown. You will learn about wildcards later in this chapter.

A generic type also identifies a *raw type*, which is a generic type without its type parameters. For example, `List<Employee>`'s raw type is `List`. Raw types are nongeneric and can hold any `Object`.

**Note** Java allows raw types to be intermixed with generic types to support the vast amount of legacy code that was written prior to the arrival of generics. However, the compiler outputs a warning message whenever it encounters a raw type in source code.

## Declaring and Using Your Own Generic Types

It's not difficult to declare your own generic types. In addition to specifying a formal type parameter list, your generic type specifies its type parameter(s) throughout its implementation. For example, Listing 6-22 declares a `Queue<E>` generic type.

*Listing 6-22. Declaring and Using a Queue<E> Generic Type*

```
public class Queue<E>
{
    private E[] elements;
    private int head, tail;

    @SuppressWarnings("unchecked")
    Queue(int size)
    {
        if (size < 2)
            throw new IllegalArgumentException("'" + size);
        elements = (E[]) new Object[size];
        head = 0;
        tail = 0;
    }

    void insert(E element) throws QueueFullException
    {
        if (isFull())
            throw new QueueFullException();
        elements[tail] = element;
        tail = (tail + 1) % elements.length;
    }
}
```

```
E remove() throws QueueEmptyException
{
    if (isEmpty())
        throw new QueueEmptyException();
    E element = elements[head];
    head = (head + 1) % elements.length;
    return element;
}

boolean isEmpty()
{
    return head == tail;
}

boolean isFull()
{
    return (tail + 1) % elements.length == head;
}

public static void main(String[] args)
    throws QueueFullException, QueueEmptyException
{
    Queue<String> queue = new Queue<String>(6);
    System.out.println("Empty: " + queue.isEmpty());
    System.out.println("Full: " + queue.isFull());
    System.out.println("Adding A");
    queue.insert("A");
    System.out.println("Adding B");
    queue.insert("B");
    System.out.println("Adding C");
    queue.insert("C");
    System.out.println("Adding D");
    queue.insert("D");
    System.out.println("Adding E");
    queue.insert("E");
    System.out.println("Empty: " + queue.isEmpty());
    System.out.println("Full: " + queue.isFull());
    System.out.println("Removing " + queue.remove());
    System.out.println("Empty: " + queue.isEmpty());
    System.out.println("Full: " + queue.isFull());
    System.out.println("Adding F");
    queue.insert("F");
    while (!queue.isEmpty())
        System.out.println("Removing " + queue.remove());
    System.out.println("Empty: " + queue.isEmpty());
    System.out.println("Full: " + queue.isFull());
}
}
```

```

class QueueEmptyException extends Exception
{
}

class QueueFullException extends Exception
{
}

```

Listing 6-22 declares `Queue`, `QueueEmptyException`, and `QueueFullException` classes. The latter two classes describe checked exceptions that are thrown from methods of the former class.

`Queue` implements a *queue*, a data structure that stores elements in first-in, first-out order. An element is inserted at the *tail* and removed at the *head*. The queue is empty when the head equals the tail and full when the tail is one less than the head. As a result, a queue of size  $n$  can store a maximum of  $n - 1$  elements.

Notice that `Queue<E>`'s `E` type parameter appears throughout the source code. For example, `E` appears in the `elements` array declaration to denote the array's element type. `E` is also specified as the type of `insert()`'s parameter and as `remove()`'s return type.

`E` also appears in `elements = (E[]) new Object[size];` (I will explain later why I specified this expression instead of specifying the more compact `elements = new E[size];` expression.)

The `E[]` cast results in the compiler warning about this cast being unchecked. The compiler is concerned that downcasting from `Object[]` to `E[]` might result in a violation of type safety because any kind of object can be stored in `Object[]`.

The compiler's concern isn't justified in this example. There is no way that a non-`E` object can appear in the `E[]` array. Because the warning is meaningless in this context, it is suppressed by prefixing the constructor with `@SuppressWarnings("unchecked")`.

**Caution** Be careful when suppressing an unchecked warning. You must first prove that a `ClassCastException` cannot occur, and then you can suppress the warning.

When you run this application, it generates the following output:

```

Empty: true
Full: false
Adding A
Adding B
Adding C
Adding D
Adding E
Empty: false
Full: true
Removing A
Empty: false
Full: false

```

```

Adding F
Removing B
Removing C
Removing D
Removing E
Removing F
Empty: true
Full: false

```

## Type Parameter Bounds

List<E>'s E type parameter and Map<K, V>'s K and V type parameters are examples of *unbounded type parameters*. You can pass any actual type argument to an unbounded type parameter.

It is sometimes necessary to restrict the kinds of actual type arguments that can be passed to a type parameter. For example, you might want to declare a class whose instances can only store instances of classes that subclass an abstract Shape class (such as Circle and Rectangle).

To restrict actual type arguments, you can specify an *upper bound*, a type that serves as an upper limit on the types that can be chosen as actual type arguments. The upper bound is specified via reserved word `extends` followed by a type name.

For example, `ShapesList<E extends Shape>` identifies Shape as an upper bound. You can specify `ShapesList<Circle>`, `ShapesList<Rectangle>`, and even `ShapesList<Shape>`, but not `ShapesList<String>` because String is not a subclass of Shape.

You can assign more than one upper bound to a type parameter, where the first bound is a class or interface and where each additional upper bound is an interface, by using the ampersand character (&) to separate bound names. Consider Listing 6-23.

*Listing 6-23. Assigning Multiple Upper Bounds to a Type Parameter*

```

abstract class Shape
{
}

class Circle extends Shape implements Comparable<Circle>
{
    private double x, y, radius;

    Circle(double x, double y, double radius)
    {
        this.x = x;
        this.y = y;
        this.radius = radius;
    }

    @Override
    public int compareTo(Circle circle)
    {
        if (radius < circle.radius)
            return -1;
    }
}

```

```

        else
        if (radius > circle.radius)
            return 1;
        else
            return 0;
    }

    @Override
    public String toString()
    {
        return "(" + x + ", " + y + ", " + radius + ")";
    }
}

class SortedShapesList<S extends Shape & Comparable<S>>
{
    @SuppressWarnings("unchecked")
    private S[] shapes = (S[]) new Shape[2];
    private int index = 0;

    void add(S shape)
    {
        shapes[index++] = shape;
        if (index < 2)
            return;
        System.out.println("Before sort: " + this);
        sort();
        System.out.println("After sort: " + this);
    }

    private void sort()
    {
        if (index == 1)
            return;
        if (shapes[0].compareTo(shapes[1]) > 0)
        {
            S shape = (S) shapes[0];
            shapes[0] = shapes[1];
            shapes[1] = shape;
        }
    }

    @Override
    public String toString()
    {
        return shapes[0].toString() + " " + shapes[1].toString();
    }
}

```

```

public class SortedShapesListDemo
{
    public static void main(String[] args)
    {
        SortedShapesList<Circle> ssl = new SortedShapesList<Circle>();
        ssl.add(new Circle(100, 200, 300));
        ssl.add(new Circle(10, 20, 30));
    }
}

```

Listing 6-23's `Circle` class extends `Shape` and implements the `java.lang.Comparable` interface, which is used to specify the *natural ordering* of `Circle` objects. The interface's `compareTo()` method implements this ordering by returning a value to reflect the order.

- A negative value is returned when the current object should precede the object passed to `compareTo()` in some fashion.
- A zero value is returned when the current and argument objects are the same.
- A positive value is returned when the current object should succeed the argument object.

`Circle`'s overriding `compareTo()` method compares two `Circle` objects based on their radii. This method orders a `Circle` instance with the smaller radius before a `Circle` instance with a larger radius.

The `SortedShapesList` class specifies `<S extends Shape & Comparable<S>>` as its parameter list. The actual type argument passed to the `S` parameter must subclass `Shape`, and it must also implement the `Comparable` interface.

**Note** A type parameter bound that includes the type parameter is known as a *recursive type bound*. For example, `Comparable<S>` in `S extends Shape & Comparable<S>` is a recursive type bound. Recursive type bounds are rare and typically show up in conjunction with the `Comparable` interface for specifying a type's natural ordering.

`Circle` satisfies both criteria: it subclasses `Shape` and implements `Comparable`. As a result, the compiler doesn't report an error when it encounters the `main()` method's `SortedShapesList<Circle> ssl = new SortedShapesList<Circle>();` statement.

An upper bound offers extra static type checking that guarantees that a parameterized type adheres to its bounds. This assurance means that the upper bound's methods can be called safely. For example, `sort()` can call `Comparable`'s `compareTo()` method.

If you run this application, you will discover the following output, which shows that the two `Circle` objects are sorted in ascending order of radius:

```

Before sort: (100.0, 200.0, 300.0) (10.0, 20.0, 30.0)
After sort: (10.0, 20.0, 30.0) (100.0, 200.0, 300.0)

```

**Note** Type parameters cannot have lower bounds. Angelika Langer explains the rationale for this restriction in her “Java Generics FAQs” at [www.angelikalanger.com/GenericsFAQ/FAQSections/TypeParameters.html#FAQ107](http://www.angelikalanger.com/GenericsFAQ/FAQSections/TypeParameters.html#FAQ107).

## Type Parameter Scope

A type parameter’s *scope* (visibility) is its generic type except where *masked* (hidden). This scope includes the formal type parameter list of which the type parameter is a member. For example, the scope of *S* in `SortedShapesList<S extends Shape & Comparable<S>>` is all of `SortedShapesList` and the formal type parameter list.

It is possible to mask a type parameter by declaring a same-named type parameter in a nested type’s formal type parameter list. For example, Listing 6-24 masks an enclosing class’s *T* type parameter.

*Listing 6-24. Masking a Type Parameter*

```
class EnclosingClass<T>
{
    static class EnclosedClass<T extends Comparable<T>>
    {
    }
}
```

`EnclosingClass`’s *T* type parameter is masked by `EnclosedClass`’s *T* type parameter, which specifies an upper bound where only those types that implement the `Comparable` interface can be passed to `EnclosedClass`. Referencing *T* from within `EnclosedClass` refers to the bounded *T* and not the unbounded *T* passed to `EnclosingClass`.

If masking is undesirable, it is best to choose a different name for the type parameter. For example, you might specify `EnclosedClass<U extends Comparable<U>>`. Although *U* is not as meaningful a name as *T*, this situation justifies this choice.

## The Need for Wildcards

Suppose that you have created a `List` of `String` and want to output this list. Because you might create a `List` of `Employee` and other kinds of lists, you want this method to output an arbitrary `List` of `Object`. You end up creating Listing 6-25.

*Listing 6-25. Attempting to Output a List of Object*

```
import java.util.ArrayList;
import java.util.List;

public class OutputList
{
    public static void main(String[] args)
```



```

{
    List<String> ls = new ArrayList<String>();
    ls.add("first");
    ls.add("second");
    ls.add("third");
    outputList(ls);
}

static void outputList(List<Object> list)
{
    for (int i = 0; i < list.size(); i++)
        System.out.println(list.get(i));
}
}

```

Now that you've accomplished your objective (or so you think), you compile Listing 6-25 via `javac OutputList.java`. Much to your surprise, you receive the following error message:

```

OutputList.java:12: error: method outputList in class OutputList cannot be applied to given types;
    outputList(ls);
    ^
   required: List<Object>
   found: List<String>
   reason: actual argument List<String> cannot be converted to List<Object> by method invocation
conversion
1 error

```

This error message results from being unaware of the fundamental rule of generic types: **for a given subtype  $x$  of type  $y$ , and given  $G$  as a raw type declaration,  $G<x>$  is not a subtype of  $G<y>$** .

To understand this rule, you must refresh your understanding of subtype polymorphism (see Chapter 4). Basically, a subtype is a specialized kind of its supertype. For example, `Circle` is a specialized kind of `Shape` and `String` is a specialized kind of `Object`. This polymorphic behavior also applies to related parameterized types with the same type parameters. For example, `List<Object>` is a specialized kind of `java.util.Collection<Object>`.

However, this polymorphic behavior doesn't apply to multiple parameterized types that differ only in regard to one type parameter being a subtype of another type parameter. For example, `List<String>` is not a specialized kind of `List<Object>`. The following example reveals why parameterized types differing only in type parameters are not polymorphic:

```

List<String> ls = new ArrayList<String>();
List<Object> lo = ls;
lo.add(new Employee());
String s = ls.get(0);

```

This example will not compile because it violates type safety. If it compiled, a `ClassCastException` instance would be thrown at runtime because of the implicit cast to `String` on the final line.

The first line instantiates a `List` of `String` and the second line upcasts its reference to a `List` of `Object`. The third line adds a new `Employee` object to the `List` of `Object`. The fourth line obtains the `Employee` object via `get()` and attempts to assign it to the `List` of `String` reference variable. However, `ClassCastException` is thrown because of the implicit cast to `String`—an `Employee` is not a `String`.

**Note** Although you cannot upcast `List<String>` to `List<Object>`, you can upcast `List<String>` to the raw type `List` in order to interoperate with legacy code.

The aforementioned error message reveals that `List` of `String` is not also `List` of `Object`. To call Listing 6-25's `outputList()` method without violating type safety, you can only pass an argument of `List<Object>` type, which limits the usefulness of this method.

However, generics offer a solution: the wildcard argument (`?`), which stands for any type. By changing `outputList()`'s parameter type from `List<Object>` to `List<?>`, you can call `outputList()` with a `List` of `String`, a `List` of `Employee`, and so on.

## Generic Methods

Suppose you need a method to copy a `List` of any kind of object to another `List`. Although you might consider coding a `void copyList(List<Object> src, List<Object> dest)` method, this method would have limited usefulness because it could only copy lists whose element type is `Object`. You couldn't copy a `List<Employee>`, for example.

If you want to pass source and destination lists whose elements are of arbitrary type (but their element types agree), you need to specify the wildcard character as a placeholder for that type. For example, you might consider writing the following `copyList()` class method that accepts collections of arbitrary-typed objects as its arguments:

```
static void copyList(List<?> src, List<?> dest)
{
    for (int i = 0; i < src.size(); i++)
        dest.add(src.get(i));
}
```

This method's parameter list is correct, but there is another problem: the compiler outputs the following error message when it encounters `dest.add(src.get(i));`:

```
CopyList.java:19: error: no suitable method found for add(Object)
    dest.add(src.get(i));
      ^
    method List.add(int,CAP#1) is not applicable
      (actual and formal argument lists differ in length)
    method List.add(CAP#1) is not applicable
      (actual argument Object cannot be converted to CAP#1 by method invocation conversion)
    where CAP#1 is a fresh type-variable:
      CAP#1 extends Object from capture of ?
1 error
```

This error message assumes that `copyList()` is part of a class named `CopyList`. Although it appears to be incomprehensible, the message basically means that the `dest.add(src.get(i))` method call violates type safety. Because `?` implies that any type of object can serve as a list's element type, it's possible that the destination list's element type is incompatible with the source list's element type.

For example, suppose you create a `List` of `String` as the source list and a `List` of `Employee` as the destination list. Attempting to add the source list's elements to the destination list, which expects `Employees`, violates type safety. If this copy operation were allowed, a `ClassCastException` instance would be thrown when trying to obtain the destination list's elements.

You could solve this problem in a limited way as follows:

```
static void copyList(List<? extends String> src,
                   List<? super String> dest)
{
    for (int i = 0; i < src.size(); i++)
        dest.add(src.get(i));
}
```

This method demonstrates a wildcard argument feature in which you can supply an upper bound or (unlike with a type parameter) a lower bound to limit the types that can be passed as actual type arguments to the generic type. Specifically, it shows an upper bound via `extends` followed by the upper bound type after the `?`, and a lower bound via `super` followed by the lower bound type after the `?`.

You interpret `? extends String` to mean that any actual type argument that is `String` or a subclass of this type can be passed, and you interpret `? super String` to imply that any actual type argument that is `String` or a superclass of this type can be passed. Because `String` cannot be subclassed, this means that you can only pass source lists of `String` and destination lists of `String` or `Object`.

The problem of copying lists of arbitrary element types to other lists can be solved through the use of a *generic method* (a class or instance method with a type-generalized implementation). Generic methods are syntactically expressed as follows:

```
<formal_type_parameter_list> return_type identifier(parameter_list)
```

The *formal\_type\_parameter\_list* is the same as when specifying a generic type: it consists of type parameters with optional bounds. A type parameter can appear as the method's *return\_type*, and type parameters can appear in the *parameter\_list*. The compiler infers the actual type arguments from the context in which the method is invoked.

You'll discover many examples of generic methods in the Collections Framework. For example, its `java.util.Collections` class provides a `public static <T extends Object & Comparable<? super T>> T min(Collection<? extends T> coll)` method for returning the minimum element in the given collection according to the natural ordering of its elements.

You can easily convert `copyList()` into a generic method by prefixing the return type with `<T>` and replacing each wildcard with `T`. The resulting method header is `<T> void copyList(List<T> src, List<T> dest)`, and Listing 6-26 presents its source code as part of an application that copies a `List` of `Circle` to another `List` of `Circle`.

*Listing 6-26. Declaring and Using a copyList() Generic Method*

```

import java.util.ArrayList;
import java.util.List;

class Circle
{
    private double x, y, radius;

    Circle(double x, double y, double radius)
    {
        this.x = x;
        this.y = y;
        this.radius = radius;
    }

    @Override
    public String toString()
    {
        return "(" + x + ", " + y + ", " + radius + ")";
    }
}

public class CopyList
{
    public static void main(String[] args)
    {
        List<String> ls = new ArrayList<String>();
        ls.add("A");
        ls.add("B");
        ls.add("C");
        outputList(ls);
        List<String> lsCopy = new ArrayList<String>();
        copyList(ls, lsCopy);
        outputList(lsCopy);
        List<Circle> lc = new ArrayList<Circle>();
        lc.add(new Circle(10.0, 20.0, 30.0));
        lc.add(new Circle(5.0, 4.0, 16.0));
        outputList(lc);
        List<Circle> lcCopy = new ArrayList<Circle>();
        copyList(lc, lcCopy);
        outputList(lcCopy);
    }

    static <T> void copyList(List<T> src, List<T> dest)
    {
        for (int i = 0; i < src.size(); i++)
            dest.add(src.get(i));
    }
}

```

```

static void outputList(List<?> list)
{
    for (int i = 0; i < list.size(); i++)
        System.out.println(list.get(i));
        System.out.println();
    }
}

```

The compiler uses a *type inference algorithm* to infer a generic method's type arguments from the context in which the method was invoked. For example, the compiler determines that `copyList(ls, lsCopy);` copies a List of String to another List of String. Similarly, it determines that `copyList(lc, lcCopy);` copies a List of Circle to another List of Circle. Without this algorithm, you would have to specify these arguments, as in `CopyList.<String>copyList(ls, lsCopy);` and `CopyList.<Circle>copyList(lc, lcCopy);`.

Compile Listing 6-26 (`javac CopyList.java`) and run this application (`java CopyList`). You should observe the following output:

```

A
B
C

A
B
C

(10.0, 20.0, 30.0)
(5.0, 4.0, 16.0)

(10.0, 20.0, 30.0)
(5.0, 4.0, 16.0)

```

## GENERIC CONSTRUCTORS

Generic and non-generic classes can declare *generic constructors* in which a constructor has a formal type parameter list. For example, you could declare the following non-generic class with a generic constructor:

```

public class GenericConstructorDemo
{
    <T> GenericConstructorDemo(T type)
    {
        System.out.println(type);
    }
}

```

```

public static void main(String[] args)
{
    GenericConstructorDemo gcd = new GenericConstructorDemo("ABC");
    gcd = new GenericConstructorDemo(new Integer(100));
}
}

```

Compile this class (`javac GenericConstructorDemo.java`) and run the resulting application (`java GenericConstructorDemo`). It outputs ABC on one line followed by 100 on the next line.

## Arrays and Generics

After presenting Listing 6-22's `Queue<E>` generic type, I mentioned that I would explain why I specified `elements = (E[]) new Object[size]`; instead of the more compact `elements = new E[size]` expression. Because of Java's generics implementation, it isn't possible to specify array-creation expressions that involve type parameters (such as `new E[size]` or `new List<E>[50]`) or actual type arguments (such as `new Queue<String>[15]`). If you attempt to do so, the compiler will report a generic array creation error message.

Before I present an example that demonstrates why allowing array-creation expressions that involve type parameters or actual type arguments is dangerous, you need to understand reification and covariance in the context of arrays, and erasure, which is at the heart of how generics are implemented.

*Reification* is representing the abstract as if it was concrete—for example, making a memory address available for direct manipulation by other language constructs. Java arrays are reified in that they're aware of their element types (an element type is stored internally) and can enforce these types at runtime. Attempting to store an invalid element in an array causes the virtual machine to throw an instance of the `java.lang.ArrayStoreException` class.

Listing 6-27 teaches you how array manipulation can lead to an `ArrayStoreException`.

*Listing 6-27. How an `ArrayStoreException` Arises*

```

class Point
{
    int x, y;
}

class ColoredPoint extends Point
{
    int color;
}

```

```

public class ReificationDemo
{
    public static void main(String[] args)
    {
        ColoredPoint[] cptArray = new ColoredPoint[1];
        Point[] ptArray = cptArray;
        ptArray[0] = new Point();
    }
}

```

Listing 6-27's `main()` method first instantiates a `ColoredPoint` array that can store one element. In contrast to this legal assignment (the types are compatible), specifying `ColoredPoint[] cptArray = new Point[1]`; is illegal (and won't compile) because it would result in a `ClassCastException` at runtime—the array knows that the assignment is illegal.

**Note** If it's not obvious, `ColoredPoint[] cptArray = new Point[1]`; is illegal because `Point` instances have fewer members (only `x` and `y`) than `ColoredPoint` instances (`x`, `y`, and `color`). Attempting to access a `Point` instance's nonexistent `color` field from its entry in the `ColoredPoint` array would result in a memory violation (because no memory has been assigned to `color`) and ultimately crash the virtual machine.

The second line (`Point[] ptArray = cptArray;`) is legal because of *covariance* (an array of supertype references is a supertype of an array of subtype references). In this case, an array of `Point` references is a supertype of an array of `ColoredPoint` references. The nonarray analogy is that a subtype is also a supertype. For example, a `java.lang.Throwable` instance is a kind of `Object` instance.

Covariance is dangerous when abused. For example, the third line (`ptArray[0] = new Point();`) results in `ArrayStoreException` at runtime because a `Point` instance is not a `ColoredPoint` instance. Without this exception, an attempt to access the nonexistent member `color` crashes the virtual machine.

Unlike with arrays, a generic type's type parameters are not reified. They're not available at runtime because they're thrown away after the source code is compiled. This "throwing away of type parameters" is a result of *erasure*, which also involves inserting casts to appropriate types when the code isn't type correct, and replacing type parameters by their upper bounds (such as `Object`).

**Note** The compiler performs erasure to let generic code interoperate with legacy (nongeneric) code. It transforms generic source code into nongeneric runtime code. One consequence of erasure is that you cannot use the `instanceof` operator with parameterized types apart from unbounded wildcard types. For example, it's illegal to specify `List<Employee> le = null; if (le instanceof ArrayList<Employee>) {}`. Instead, you must change the `instanceof` expression to `le instanceof ArrayList<?>` (unbounded wildcard) or `le instanceof ArrayList` (raw type, which is the preferred use).

Suppose you could specify an array-creation expression involving a type parameter or an actual type argument. Why would this be bad? For an answer, consider the following example, which should generate an `ArrayStoreException` instead of a `ClassCastException` but doesn't do so:

```
List<Employee>[] empListArray = new ArrayList<Employee>[1];
List<String> strList = new ArrayList<String>();
strList.add("string");
Object[] objArray = empListArray;
objArray[0] = strList;
Employee e = empListArray[0].get(0);
```

Assume that the first line, which creates a one-element array where this element stores a `List` of `Employee`, is legal. The second line creates a `List` of `String`, and the third line stores a single `String` object in this list.

The fourth line assigns `empListArray` to `objArray`. This assignment is legal because arrays are covariant and erasure converts `List<Employee>[]` to the `List` runtime type and `List` subtypes `Object`.

Because of erasure, the virtual machine doesn't throw `ArrayStoreException` when it encounters `objArray[0] = strList;`. After all, you're assigning a `List` reference to a `List[]` array at runtime. However, this exception would be thrown if generic types were reified because you'd then be assigning a `List<String>` reference to a `List<Employee>[]` array.

However, there is a problem. A `List<String>` instance has been stored in an array that can only hold `List<Employee>` instances. When the compiler-inserted cast operator attempts to cast `empListArray[0].get(0)`'s return value ("string") to `Employee`, the cast operator throws a `ClassCastException` object.

## Mastering Enums

An *enumerated type* is a type that specifies a named sequence of related constants as its legal values. The months in a calendar, the coins in a currency, and the days of the week are examples of enumerated types.

Java developers have traditionally used sets of named integer constants to represent enumerated types. Because this form of representation has proven to be problematic, Java 5 introduced the `enum` alternative.

In this section, I will introduce you to enums. After discussing the problems with traditional enumerated types, I will present the `enum` alternative. I will then introduce you to the `Enum` class, from which enums originate.

## The Trouble with Traditional Enumerated Types

Listing 6-28 declares a `Coin` enumerated type whose set of constants identifies different kinds of coins in a currency.



*Listing 6-28. An Enumerated Type Identifying Coins*

```
class Coin
{
    final static int PENNY = 0;
    final static int NICKEL = 1;
    final static int DIME = 2;
    final static int QUARTER = 3;
}
```

Listing 6-29 declares a Weekday enumerated type whose constants identify the days of the week.

*Listing 6-29. An Enumerated Type Identifying Weekdays*

```
class Weekday
{
    final static int SUNDAY = 0;
    final static int MONDAY = 1;
    final static int TUESDAY = 2;
    final static int WEDNESDAY = 3;
    final static int THURSDAY = 4;
    final static int FRIDAY = 5;
    final static int SATURDAY = 6;
}
```

Listing 6-28's and 6-29's approach to representing an enumerated type is problematic, where the biggest problem is the lack of compile-time type safety. For example, you can pass a coin to a method that requires a weekday and the compiler will not complain.

You can also compare coins to weekdays, as in `Coin.NICKEL == Weekday.MONDAY`, and specify even more meaningless expressions, such as `Coin.DIME + Weekday.FRIDAY - 1 / Coin.QUARTER`. The compiler doesn't complain because it only sees ints.

Applications that depend upon enumerated types are brittle. Because the type's constants are compiled into an application's classfiles, changing a constant's int value requires you to recompile dependent applications or risk them behaving erratically.

Another problem with enumerated types is that int constants cannot be translated into meaningful string descriptions. For example, what does the number 4 mean when debugging a faulty application? Being able to see THURSDAY instead of 4 would be more helpful.

**Note** You could circumvent the previous problem by using String constants. For example, you might specify `public final static String THURSDAY = "THURSDAY"`; Although the constant value is more meaningful, String-based constants can impact performance because you cannot use `==` to efficiently compare just any old strings (as you will discover in Chapter 7). Other problems related to String-based constants include hard-coding the constant's value ("THURSDAY") instead of the constant's name (THURSDAY) into source code, which makes it very difficult to change the constant's value at a later time; and misspelling a hard-coded constant ("THURZDAY"), which compiles correctly but is problematic at runtime.

## The Enum Alternative

Java 5 introduced enums as a better alternative to traditional enumerated types. An *enum* is an enumerated type that is expressed via reserved word `enum`. The following example uses `enum` to declare Listing 6-28's and 6-29's enumerated types:

```
enum Coin { PENNY, NICKEL, DIME, QUARTER }
enum Weekday { SUNDAY, MONDAY, TUESDAY, WEDNESDAY, THURSDAY, FRIDAY, SATURDAY }
```

Despite their similarity to the `int`-based enumerated types found in C++ and other languages, this example's enums are classes. Each constant is a `public static final` field that represents an instance of its enum class.

Because constants are final, and because you cannot call an enum's constructors to create more constants, you can use `==` to compare constants efficiently and (unlike string constant comparisons) safely. For example, you can specify `c == Coin.NICKEL`.

Enums promote compile-time type safety by preventing you from comparing constants in different enums. For example, the compiler will report an error when it encounters `Coin.PENNY == Weekday.SUNDAY`.

The compiler also frowns on passing a constant of the wrong enum kind to a method. For example, you cannot pass `Weekday.FRIDAY` to a method whose parameter type is `Coin`.

Applications depending on enums are not brittle because the enum's constants are not compiled into an application's classfiles. Also, the enum provides a `toString()` method for returning a more useful description of a constant's value.

Because enums are so useful, Java 5 enhanced the `switch` statement to support them. Listing 6-30 demonstrates this statement switching on one of the constants in the previous example's `Coin` enum.

*Listing 6-30. Using the Switch Statement with an Enum*

```
public class EnhancedSwitch
{
    enum Coin { PENNY, NICKEL, DIME, QUARTER }

    public static void main(String[] args)
    {
        Coin coin = Coin.NICKEL;
        switch (coin)
        {
            case PENNY : System.out.println("1 cent"); break;
            case NICKEL : System.out.println("5 cents"); break;
            case DIME : System.out.println("10 cents"); break;
            case QUARTER: System.out.println("25 cents"); break;
            default : assert false;
        }
    }
}
```

Listing 6-30 demonstrates switching on an enum's constants. This enhanced statement only allows you to specify the name of a constant as a case label. If you prefix the name with the enum, as in case `Coin.DIME`, the compiler reports an error.

## Enhancing an Enum

You can add fields, constructors, and methods to an enum—you can even have the enum implement interfaces. For example, Listing 6-31 adds a field, a constructor, and two methods to `Coin` to associate a denomination value with a `Coin` constant (such as 1 for penny and 5 for nickel) and convert pennies to the denomination.

*Listing 6-31. Enhancing the Coin Enum*

```
enum Coin
{
    PENNY(1),
    NICKEL(5),
    DIME(10),
    QUARTER(25);

    private final int denomValue;

    Coin(int denomValue)
    {
        this.denomValue = denomValue;
    }

    int denomValue()
    {
        return denomValue;
    }

    int toDenomination(int numPennies)
    {
        return numPennies / denomValue;
    }
}
```

Listing 6-31's constructor accepts a denomination value, which it assigns to a private blank final field named `denomValue`—all fields should be declared `final` because constants are immutable. Notice that this value is passed to each constant during its creation (`PENNY(1)`, for example).

**Caution** When the comma-separated list of constants is followed by anything other than an enum's closing brace, you must terminate the list with a semicolon or the compiler will report an error.

Furthermore, this listing's `denomValue()` method returns `denomValue`, and its `toDenomination()` method returns the number of coins of that denomination that are contained within the number of pennies passed to this method as its argument. For example, 3 nickels are contained in 16 pennies.

Listing 6-32 shows how to use the enhanced `Coin` enum.

*Listing 6-32. Exercising the Enhanced `Coin` Enum*

```
public class Coins
{
    public static void main(String[] args)
    {
        if (args.length == 1)
        {
            int numPennies = Integer.parseInt(args[0]);
            System.out.println(numPennies + " pennies is equivalent to:");
            int numQuarters = Coin.QUARTER.toDenomination(numPennies);
            System.out.println(numQuarters + " " + Coin.QUARTER.toString() +
                (numQuarters != 1 ? "s," : ","));
            numPennies -= numQuarters * Coin.QUARTER.denomValue();
            int numDimes = Coin.DIME.toDenomination(numPennies);
            System.out.println(numDimes + " " + Coin.DIME.toString() +
                (numDimes != 1 ? "s, " : ","));
            numPennies -= numDimes * Coin.DIME.denomValue();
            int numNickels = Coin.NICKEL.toDenomination(numPennies);
            System.out.println(numNickels + " " + Coin.NICKEL.toString() +
                (numNickels != 1 ? "s, " : ", and"));
            numPennies -= numNickels * Coin.NICKEL.denomValue();
            System.out.println(numPennies + " " + Coin.PENNY.toString() +
                (numPennies != 1 ? "s" : ""));
        }
        System.out.println();
        System.out.println("Denomination values:");
        for (int i = 0; i < Coin.values().length; i++)
            System.out.println(Coin.values()[i].denomValue());
    }
}
```

Listing 6-32 describes an application that converts its solitary “pennies” command-line argument to an equivalent amount expressed in quarters, dimes, nickels, and pennies. In addition to calling a `Coin` constant's `denomValue()` and `toDenomValue()` methods, the application calls `toString()` to output a string representation of the coin.

Another called enum method is `values()`. This method returns an array of all `Coin` constants that are declared in the `Coin` enum (`value()`'s return type, in this example, is `Coin[]`). This array is useful when you need to iterate over these constants. For example, Listing 6-32 calls this method to output each coin's denomination.

When you run this application with 119 as its command-line argument (`java Coins 119`), it generates the following output:

```
119 pennies is equivalent to:
4 QUARTERS,
1 DIME,
1 NICKEL, and
4 PENNYS
```

```
Denomination values:
1
5
10
25
```

The output shows that `toString()` returns a constant's name. It is sometimes useful to override this method to return a more meaningful value. For example, a method that extracts *tokens* (named character sequences) from a string might use a `Token` enum to list token names and, via an overriding `toString()` method, values—see Listing 6-33.

*Listing 6-33. Overriding `toString()` to Return a Token Constant's Value*

```
public enum Token
{
    IDENTIFIER("ID"),
    INTEGER("INT"),
    LPAREN("("),
    RPAREN(")"),
    COMMA(",");

    private final String tokValue;

    Token(String tokValue)
    {
        this.tokValue = tokValue;
    }

    @Override
    public String toString()
    {
        return tokValue;
    }

    public static void main(String[] args)
    {
        System.out.println("Token values:");
        for (int i = 0; i < Token.values().length; i++)
            System.out.println(Token.values()[i].name() + " = " +
                               Token.values()[i]);
    }
}
```

Listing 6-33's `main()` method calls `values()` to return the array of Token constants. For each constant, it calls the constant's `name()` method to return the constant's name, and implicitly calls `toString()` to return the constant's value. If you were to run this application, you would observe the following output:

```
Token values:
IDENTIFIER = ID
INTEGER = INT
LPAREN = (
RPAREN = )
COMMA = ,
```

Another way to enhance an enum is to assign a different behavior to each constant. You can accomplish this task by introducing an abstract method into the enum and overriding this method in an anonymous subclass of the constant. Listing 6-34's `TempConversion` enum demonstrates this technique.

*Listing 6-34. Using Anonymous Subclasses to Vary the Behaviors of Enum Constants*

```
public enum TempConversion
{
    C2F("Celsius to Fahrenheit")
    {
        @Override
        double convert(double value)
        {
            return value * 9.0 / 5.0 + 32.0;
        }
    },

    F2C("Fahrenheit to Celsius")
    {
        @Override
        double convert(double value)
        {
            return (value - 32.0) * 5.0 / 9.0;
        }
    };

    TempConversion(String desc)
    {
        this.desc = desc;
    }

    private String desc;

    @Override
    public String toString()
    {
        return desc;
    }
}
```

```

abstract double convert(double value);

public static void main(String[] args)
{
    System.out.println(C2F + " for 100.0 degrees = " + C2F.convert(100.0));
    System.out.println(F2C + " for 98.6 degrees = " + F2C.convert(98.6));
}
}

```

When you run this application, it generates the following output:

```

Celsius to Fahrenheit for 100.0 degrees = 212.0
Fahrenheit to Celsius for 98.6 degrees = 37.0

```

## The Enum Class

The compiler regards enum as syntactic sugar. When it encounters an enum type declaration (enum Coin {}), it generates a class whose name (Coin) is specified by the declaration, which also subclasses the abstract Enum class (in the java.lang package), the common base class of all Java language-based enumeration types.

If you examine Enum's Java documentation, you will discover that it overrides Object's clone(), equals(), finalize(), hashCode(), and toString() methods.

- clone() is overridden to prevent constants from being cloned so that there is never more than one copy of a constant; otherwise, constants could not be compared via ==.
- equals() is overridden to compare constants via their references—constants with the same identities (==) must have the same contents (equals()), and different identities imply different contents.
- finalize() is overridden to ensure that constants cannot be finalized.
- hashCode() is overridden because equals() is overridden.
- toString() is overridden to return the constant's name.

Except for toString(), all of the overriding methods are declared final so that they cannot be overridden in a subclass.

Enum also provides its own methods. These methods include the final compareTo(), (Enum implements Comparable), getDeclaringClass(), name(), and ordinal() methods.

- compareTo() compares the current constant with the constant passed as an argument to see which constant precedes the other constant in the enum and returns a value indicating their order. This method makes it possible to sort an array of unsorted constants.
- getDeclaringClass() returns the Class object corresponding to the current constant's enum. For example, the Class object for Coin is returned when calling Coin.PENNY.getDeclaringClass() for enum Coin { PENNY, NICKEL, DIME, QUARTER}. Also, TempConversion is returned when calling TempConversion.C2F.getDeclaringClass() for Listing 6-34's TempConversion enum. The compareTo()

method uses `Class`'s `getClass()` method and `Enum`'s `getDeclaringClass()` method to ensure that only constants belonging to the same enum are compared. Otherwise, a `ClassCastException` is thrown.

- `name()` returns the constant's name. Unless overridden to return something more descriptive, `toString()` also returns the constant's name.
- `ordinal()` returns a zero-based *ordinal*, an integer that identifies the position of the constant within the enum type. `compareTo()` compares ordinals.

`Enum` also provides the public static `<T extends Enum<T>> T valueOf(Class<T> enumType, String name)` method for returning the enum constant from the specified enum with the specified name.

- `enumType` identifies the `Class` object of the enum from which to return a constant.
- `name` identifies the name of the constant to return.

For example, `Coin penny = Enum.valueOf(Coin.class, "PENNY");` assigns the `Coin` constant whose name is `PENNY` to `penny`.

You will not discover a `values()` method in `Enum`'s Java documentation because the compiler *synthesizes* (manufactures) this method while generating the class.

## Extending the Enum Class

`Enum`'s generic type is `Enum<E extends Enum<E>>`. Although the formal type parameter list looks ghastly, it's not that hard to understand. But first, take a look at Listing 6-35.

*Listing 6-35. The Coin Class As It Appears from the Perspective of Its Classfile*

```
public final class Coin extends Enum<Coin>
{
    public static final Coin PENNY = new Coin("PENNY", 0);
    public static final Coin NICKEL = new Coin("NICKEL", 1);
    public static final Coin DIME = new Coin("DIME", 2);
    public static final Coin QUARTER = new Coin("QUARTER", 3);
    private static final Coin[] $VALUES = { PENNY, NICKEL, DIME, QUARTER };

    public static Coin[] values()
    {
        return Coin.$VALUES.clone();
    }

    public static Coin valueOf(String name)
    {
        return Enum.valueOf(Coin.class, "Coin");
    }

    private Coin(String name, int ordinal)
    {
        super(name, ordinal);
    }
}
```



Behind the scenes, the compiler converts `enum Coin { PENNY, NICKEL, DIME, QUARTER}` into a class declaration that is similar to Listing 6-35.

The following rules show you how to interpret `Enum<E extends Enum<E>>` in the context of `Coin extends Enum<Coin>`:

- Any subclass of `Enum` must supply an actual type argument to `Enum`. For example, `Coin`'s header specifies `Enum<Coin>`.
- The actual type argument must be a subclass of `Enum`. For example, `Coin` is a subclass of `Enum`.
- A subclass of `Enum` (such as `Coin`) must follow the idiom that it supplies its own name (`Coin`) as an actual type argument.

The third rule allows `Enum` to declare methods—`compareTo()`, `getDeclaringClass()`, and `valueOf()`—whose parameter and/or return types are specified in terms of the subclass (`Coin`) and not in terms of `Enum`. The rationale for doing this is to avoid having to specify casts. For example, you don't need to cast `valueOf()`'s return value to `Coin` in `Coin penny = Enum.valueOf(Coin.class, "PENNY");`.

**Note** You cannot compile Listing 6-35 because the compiler will not compile any class that extends `Enum`. It will also complain about `super(name, ordinal);`.

## EXERCISES

The following exercises are designed to test your understanding of Chapter 6's content.

1. What is an assertion?
2. When would you use assertions?
3. True or false: Specifying the `-ea` command-line option with no argument enables all assertions, including system assertions.
4. Define annotation.
5. What kinds of application elements can be annotated?
6. Identify the three compiler-supported annotation types.
7. How do you declare an annotation type?
8. What is a marker annotation?
9. What is an element?
10. How do you assign a default value to an element?
11. What is a meta-annotation?
12. Identify Java's four meta-annotation types.
13. Define generics.

14. Why would you use generics?
15. What is the difference between a generic type and a parameterized type?
16. Which one of the nonstatic member class, local class, and anonymous class inner class categories cannot be generic?
17. Identify the five kinds of actual type arguments.
18. True or false: You cannot specify the name of a primitive type (such as double or int) as an actual type argument.
19. What is a raw type?
20. When does the compiler report an unchecked warning message and why?
21. How do you suppress an unchecked warning message?
22. True or false: List<E>'s E type parameter is unbounded.
23. How do you specify a single upper bound?
24. What is a recursive type bound?
25. Why are wildcard type arguments necessary?
26. What is a generic method?
27. In Listing 6-36, which overloaded method does the methodCaller() generic method call?

*Listing 6-36. Which someOverloadedMethod() Is Called?*

```
import java.util.Date;

public class CallOverloadedNGMethodFromGMethod
{
    public static void someOverloadedMethod(Object o)
    {
        System.out.println("call to someOverloadedMethod(Object o)");
    }
    public static void someOverloadedMethod(Date d)
    {
        System.out.println("call to someOverloadedMethod(Date d)");
    }
    public static <T> void methodCaller(T t)
    {
        someOverloadedMethod(t);
    }
    public static void main(String[] args)
    {
        methodCaller(new Date());
    }
}
```

28. What is reification?
  29. True or false: Type parameters are reified.
  30. What is erasure?
  31. Define enumerated type.
  32. Identify three problems that can arise when you use enumerated types whose constants are `int`-based.
  33. What is an enum?
  34. How do you use the switch statement with an enum?
  35. In what ways can you enhance an enum?
  36. What is the purpose of the abstract Enum class?
  37. What is the difference between Enum's `name()` and `toString()` methods?
  38. True or false: Enum's generic type is `Enum<E extends Enum<E>>`.
  39. Declare a `ToDo` marker annotation type that annotates only type elements and that also uses the default retention policy.
  40. Rewrite the `StubFinder` application to work with Listing 6-13's `Stub` annotation type (with appropriate `@Target` and `@Retention` annotations) and Listing 6-14's `Deck` class.
  41. Implement a `Stack<E>` generic type in a manner that is similar to Listing 6-22's `Queue` class. `Stack` must declare `push()`, `pop()`, and `isEmpty()` methods (it could also declare an `isFull()` method, but that method is not necessary in this exercise); `push()` must throw a `StackFullException` instance when the stack is full; and `pop()` must throw a `StackEmptyException` instance when the stack is empty. (You must create your own `StackFullException` and `StackEmptyException` helper classes because they are not provided for you in the standard class library.) Declare a similar `main()` method, and insert two assertions into this method that validate your assumptions about the stack being empty immediately after being created and immediately after popping the last element.
  42. Declare a `Compass` enum with `NORTH`, `SOUTH`, `EAST`, and `WEST` members. Declare a `UseCompass` class whose `main()` method randomly selects one of these constants and then switches on that constant. Each of the switch statement's cases should output a message such as heading `north`.
- 

## Summary

An assertion is a statement that lets you express an assumption of application correctness via a Boolean expression. If this expression evaluates to true, execution continues with the next statement. Otherwise, an error that identifies the cause of failure is thrown.

There are many situations where assertions should be used. These situations organize into internal invariant, control-flow invariant, and design-by-contract categories. An invariant is something that doesn't change.

Although there are many situations where assertions should be used, there also are situations where they should be avoided. For example, you should not use assertions to check the arguments that are passed to public methods.

The compiler records assertions in the classfile. However, assertions are disabled at runtime because they can affect performance. You must enable the classfile's assertions before you can test assumptions about the behaviors of your classes.

Annotations are instances of annotation types and associate metadata with application elements. They are expressed in source code by prefixing their type names with @ symbols. For example, `@ReadOnly` is an annotation and `ReadOnly` is its type.

Java supplies a wide variety of annotation types, including the compiler-oriented `Override`, `Deprecated`, and `SuppressWarnings` types. However, you can also declare your own annotation types by using the `@interface` syntax.

Annotation types can be annotated with meta-annotations that identify the application elements they can target (such as constructors, methods, or fields), their retention policies, and other characteristics.

Annotations whose types are assigned a runtime retention policy via `@Retention` annotations can be processed at runtime using custom applications. (Java 5 introduced an `apt` tool for this purpose, but its functionality was largely integrated into the compiler starting with Java 6.)

Java 5 introduced generics, language features for declaring and using type-agnostic classes and interfaces. While working with Java's Collections Framework, these features help you avoid `ClassCastException`s.

A generic type is a class or interface that introduces a family of parameterized types by declaring a formal type parameter list. The type name that replaces a type parameter is known as an actual type argument.

There are five kinds of actual type arguments: concrete type, concrete parameterized type, array type, type parameter, and wildcard. Furthermore, a generic type also identifies a raw type, which is a generic type without its type parameters.

A generic method is a class or instance method with a type-generalized implementation, for example, `<T> void copyList(List<T> src, List<T> dest)`. The compiler infers the actual type argument from the context in which the method is invoked.

An enumerated type is a type that specifies a named sequence of related constants as its legal values. Java developers have traditionally used sets of named integer constants to represent enumerated types.

Because sets of named integer constants have proven to be problematic, Java 5 introduced the `enum` alternative. An `enum` is an enumerated type that is expressed in source code via reserved word `enum`.

You can add fields, constructors, and methods to an `enum`—you can even have the `enum` implement interfaces. Also, you can override `toString()` to provide a more useful description of a constant's value, and subclass constants to assign different behaviors.

The compiler regards `enum` as syntactic sugar for a class that subclasses `Enum`. This abstract class overrides various `Object` methods to provide default behaviors (usually for safety reasons), and provides additional methods for various purposes.

This chapter largely completes a tour of the Java language. In Chapter 7, I will begin to emphasize Java APIs by focusing on those basic APIs related to mathematics, string management, and more.

# Exploring the Basic APIs, Part 1

The standard class library's `java.lang` and other packages provide many basic APIs that can benefit your Android apps. For example, you can perform mathematics operations and manipulate strings.

## Exploring Math

The `java.lang.Math` class declares `double` constants `E` and `PI` that represent the natural logarithm base value (2.71828...) and the ratio of a circle's circumference to its diameter (3.14159...). `E` is initialized to 2.718281828459045 and `PI` is initialized to 3.141592653589793. `Math` also declares class methods that perform various mathematics operations. Table 7-1 describes many of these methods.

**Table 7-1.** *Math Methods*

Method	Description
<code>double abs(double d)</code>	Returns the absolute value of <code>d</code> . There are four special cases: <code>abs(-0.0) = +0.0</code> , <code>abs(+infinity) = +infinity</code> , <code>abs(-infinity) = +infinity</code> , and <code>abs(NaN) = NaN</code> .
<code>float abs(float f)</code>	Returns the absolute value of <code>f</code> . There are four special cases: <code>abs(-0.0) = +0.0</code> , <code>abs(+infinity) = +infinity</code> , <code>abs(-infinity) = +infinity</code> , and <code>abs(NaN) = NaN</code> .
<code>int abs(int i)</code>	Returns the absolute value of <code>i</code> . There is one special case: the absolute value of <code>Integer.MIN_VALUE</code> is <code>Integer.MIN_VALUE</code> .
<code>long abs(long l)</code>	Returns the absolute value of <code>l</code> . There is one special case: the absolute value of <code>Long.MIN_VALUE</code> is <code>Long.MIN_VALUE</code> .
<code>double acos(double d)</code>	Returns angle <code>d</code> 's arc cosine within the range 0 through <code>PI</code> . There are three special cases: <code>acos(anything &gt; 1) = NaN</code> , <code>acos(anything &lt; -1) = NaN</code> , and <code>acos(NaN) = NaN</code> .
<code>double asin(double d)</code>	Returns angle <code>d</code> 's arc sine within the range <code>-PI/2</code> through <code>PI/2</code> . There are three special cases: <code>asin(anything &gt; 1) = NaN</code> , <code>asin(anything &lt; -1) = NaN</code> , and <code>asin(NaN) = NaN</code> .

(continued)

Table 7-1. (continued)

Method	Description
double atan(double d)	Returns angle d's arc tangent within the range $-\pi/2$ through $\pi/2$ . There are five special cases: $\text{atan}(+0.0) = +0.0$ , $\text{atan}(-0.0) = -0.0$ , $\text{atan}(+\infty) = +\pi/2$ , $\text{atan}(-\infty) = -\pi/2$ , and $\text{atan}(\text{NaN}) = \text{NaN}$ .
double ceil(double d)	Returns the smallest value (closest to negative infinity) that is not less than d and is equal to an integer. There are six special cases: $\text{ceil}(+0.0) = +0.0$ , $\text{ceil}(-0.0) = -0.0$ , $\text{ceil}(\text{anything} > -1.0 \text{ and } < 0.0) = -0.0$ , $\text{ceil}(+\infty) = +\infty$ , $\text{ceil}(-\infty) = -\infty$ , and $\text{ceil}(\text{NaN}) = \text{NaN}$ .
double cos(double d)	Returns the cosine of angle d (expressed in radians). There are three special cases: $\text{cos}(+\infty) = \text{NaN}$ , $\text{cos}(-\infty) = \text{NaN}$ , and $\text{cos}(\text{NaN}) = \text{NaN}$ .
double exp(double d)	Returns Euler's number e to the power d. There are three special cases: $\text{exp}(+\infty) = +\infty$ , $\text{exp}(-\infty) = +0.0$ , and $\text{exp}(\text{NaN}) = \text{NaN}$ .
double floor(double d)	Returns the largest value (closest to positive infinity) that is not greater than d and is equal to an integer. There are five special cases: $\text{floor}(+0.0) = +0.0$ , $\text{floor}(-0.0) = -0.0$ , $\text{floor}(+\infty) = +\infty$ , $\text{floor}(-\infty) = -\infty$ , and $\text{floor}(\text{NaN}) = \text{NaN}$ .
double log(double d)	Returns the natural logarithm (base e) of d. There are six special cases: $\text{log}(+0.0) = -\infty$ , $\text{log}(-0.0) = -\infty$ , $\text{log}(\text{anything} < 0) = \text{NaN}$ , $\text{log}(+\infty) = +\infty$ , $\text{log}(-\infty) = \text{NaN}$ , and $\text{log}(\text{NaN}) = \text{NaN}$ .
double log10(double d)	Returns the base 10 logarithm of d. There are six special cases: $\text{log10}(+0.0) = -\infty$ , $\text{log10}(-0.0) = -\infty$ , $\text{log10}(\text{anything} < 0) = \text{NaN}$ , $\text{log10}(+\infty) = +\infty$ , $\text{log10}(-\infty) = \text{NaN}$ , and $\text{log10}(\text{NaN}) = \text{NaN}$ .
double max(double d1, double d2)	Returns the most positive (closest to positive infinity) of d1 and d2. There are four special cases: $\text{max}(\text{NaN}, \text{anything}) = \text{NaN}$ , $\text{max}(\text{anything}, \text{NaN}) = \text{NaN}$ , $\text{max}(+0.0, -0.0) = +0.0$ , and $\text{max}(-0.0, +0.0) = +0.0$ .
float max(float f1, float f2)	Returns the most positive (closest to positive infinity) of f1 and f2. There are four special cases: $\text{max}(\text{NaN}, \text{anything}) = \text{NaN}$ , $\text{max}(\text{anything}, \text{NaN}) = \text{NaN}$ , $\text{max}(+0.0, -0.0) = +0.0$ , and $\text{max}(-0.0, +0.0) = +0.0$ .
int max(int i1, int i2)	Returns the most positive (closest to positive infinity) of i1 and i2.
long max(long l1, long l2)	Returns the most positive (closest to positive infinity) of l1 and l2.
double min(double d1, double d2)	Returns the most negative (closest to negative infinity) of d1 and d2. There are four special cases: $\text{min}(\text{NaN}, \text{anything}) = \text{NaN}$ , $\text{min}(\text{anything}, \text{NaN}) = \text{NaN}$ , $\text{min}(+0.0, -0.0) = -0.0$ , and $\text{min}(-0.0, +0.0) = -0.0$ .
float min(float f1, float f2)	Returns the most negative (closest to negative infinity) of f1 and f2. There are four special cases: $\text{min}(\text{NaN}, \text{anything}) = \text{NaN}$ , $\text{min}(\text{anything}, \text{NaN}) = \text{NaN}$ , $\text{min}(+0.0, -0.0) = -0.0$ , and $\text{min}(-0.0, +0.0) = -0.0$ .
int min(int i1, int i2)	Returns the most negative (closest to negative infinity) of i1 and i2.
long min(long l1, long l2)	Returns the most negative (closest to negative infinity) of l1 and l2.
double random()	Returns a pseudorandom number between 0.0 (inclusive) and 1.0 (exclusive).

(continued)

Table 7-1. (continued)

Method	Description
<code>long round(double d)</code>	Returns the result of rounding <code>d</code> to a long integer. The result is equivalent to <code>(long) Math.floor(d + 0.5)</code> . There are seven special cases: <code>round(+0.0) = +0.0</code> , <code>round(-0.0) = +0.0</code> , <code>round(anything &gt; Long.MAX_VALUE) = Long.MAX_VALUE</code> , <code>round(anything &lt; Long.MIN_VALUE) = Long.MIN_VALUE</code> , <code>round(+infinity) = Long.MAX_VALUE</code> , <code>round(-infinity) = Long.MIN_VALUE</code> , and <code>round(NaN) = +0.0</code> .
<code>int round(float f)</code>	Returns the result of rounding <code>f</code> to an integer. The result is equivalent to <code>(int) Math.floor(f + 0.5)</code> . There are seven special cases: <code>round(+0.0) = +0.0</code> , <code>round(-0.0) = +0.0</code> , <code>round(anything &gt; Integer.MAX_VALUE) = Integer.MAX_VALUE</code> , <code>round(anything &lt; Integer.MIN_VALUE) = Integer.MIN_VALUE</code> , <code>round(+infinity) = Integer.MAX_VALUE</code> , <code>round(-infinity) = Integer.MIN_VALUE</code> , and <code>round(NaN) = +0.0</code> .
<code>double signum(double d)</code>	Returns the sign of <code>d</code> as <code>-1.0</code> ( <code>d</code> less than <code>0.0</code> ), <code>0.0</code> ( <code>d</code> equals <code>0.0</code> ), and <code>1.0</code> ( <code>d</code> greater than <code>0.0</code> ). There are five special cases: <code>signum(+0.0) = +0.0</code> , <code>signum(-0.0) = -0.0</code> , <code>signum(+infinity) = +1.0</code> , <code>signum(-infinity) = -1.0</code> , and <code>signum(NaN) = NaN</code> .
<code>float signum(float f)</code>	Returns the sign of <code>f</code> as <code>-1.0</code> ( <code>f</code> less than <code>0.0</code> ), <code>0.0</code> ( <code>f</code> equals <code>0.0</code> ), and <code>1.0</code> ( <code>f</code> greater than <code>0.0</code> ). There are five special cases: <code>signum(+0.0) = +0.0</code> , <code>signum(-0.0) = -0.0</code> , <code>signum(+infinity) = +1.0</code> , <code>signum(-infinity) = -1.0</code> , and <code>signum(NaN) = NaN</code> .
<code>double sin(double d)</code>	Returns the sine of angle <code>d</code> (expressed in radians). There are five special cases: <code>sin(+0.0) = +0.0</code> , <code>sin(-0.0) = -0.0</code> , <code>sin(+infinity) = NaN</code> , <code>sin(-infinity) = NaN</code> , and <code>sin(NaN) = NaN</code> .
<code>double sqrt(double d)</code>	Returns the square root of <code>d</code> . There are five special cases: <code>sqrt(+0.0) = +0.0</code> , <code>sqrt(-0.0) = -0.0</code> , <code>sqrt(anything &lt; 0) = NaN</code> , <code>sqrt(+infinity) = +infinity</code> , and <code>sqrt(NaN) = NaN</code> .
<code>double tan(double d)</code>	Returns the tangent of angle <code>d</code> (expressed in radians). There are five special cases: <code>tan(+0.0) = +0.0</code> , <code>tan(-0.0) = -0.0</code> , <code>tan(+infinity) = NaN</code> , <code>tan(-infinity) = NaN</code> , and <code>tan(NaN) = NaN</code> .
<code>double toDegrees(double angrad)</code>	Converts angle <code>angrad</code> from radians to degrees via expression <code>angrad * 180 / PI</code> . There are five special cases: <code>toDegrees(+0.0) = +0.0</code> , <code>toDegrees(-0.0) = -0.0</code> , <code>toDegrees(+infinity) = +infinity</code> , <code>toDegrees(-infinity) = -infinity</code> , and <code>toDegrees(NaN) = NaN</code> .
<code>double toRadians(double angdeg)</code>	Converts angle <code>angdeg</code> from degrees to radians via expression <code>angdeg / 180 * PI</code> . There are five special cases: <code>toRadians(+0.0) = +0.0</code> , <code>toRadians(-0.0) = -0.0</code> , <code>toRadians(+infinity) = +infinity</code> , <code>toRadians(-infinity) = -infinity</code> , and <code>toRadians(NaN) = NaN</code> .

Table 7-1 reveals a wide variety of useful math-oriented methods. For example, each `abs()` method returns its argument's *absolute value* (number without regard for sign).

`abs(double)` and `abs(float)` are useful for comparing double precision floating-point and floating-point values safely. For example, `0.3 == 0.1 + 0.1 + 0.1` evaluates to `false` because `0.1` has no exact representation. However, you can compare these expressions with `abs()` and a tolerance

value, which indicates an acceptable range of error. For example, `Math.abs(0.3 - (0.1 + 0.1 + 0.1)) < 0.1` returns true because the absolute difference between 0.3 and `0.1 + 0.1 + 0.1` is less than a 0.1 tolerance value.

`random()` (which returns a number that appears to be randomly chosen but is actually chosen by a predictable math calculation and hence is *pseudorandom*) is useful in simulations (as well as in games and wherever an element of chance is needed). However, its double precision floating-point range of 0.0 through (almost) 1.0 isn't practical. To make `random()` more useful, its return value must be transformed into a more useful range, perhaps integer values 0 through 49, or maybe -100 through 100. You will find the following `rnd()` method useful for making these transformations:

```
static int rnd(int limit)
{
    return (int) (Math.random() * limit);
}
```

`rnd()` transforms `random()`'s 0.0 to (almost) 1.0 double precision floating-point range to a 0 through `limit - 1` integer range. For example, `rnd(50)` returns an integer ranging from 0 through 49. Also, `-100 + rnd(201)` transforms 0.0 to (almost) 1.0 into -100 through 100 by adding a suitable offset and passing an appropriate limit value.

**Caution** Don't specify `(int) Math.random() * limit` because this expression always evaluates to 0. The expression first casts `random()`'s double precision floating-point fractional value (0.0 through 0.99999...) to integer 0 by truncating the fractional part and then multiplies 0 by `limit`, which results in 0.

The `sin()` and `cos()` methods implement the sine and cosine trigonometric functions—see [http://en.wikipedia.org/wiki/Trigonometric\\_functions](http://en.wikipedia.org/wiki/Trigonometric_functions). These functions have uses ranging from the study of triangles to modeling periodic phenomena (such as simple harmonic motion—see [http://en.wikipedia.org/wiki/Simple\\_harmonic\\_motion](http://en.wikipedia.org/wiki/Simple_harmonic_motion)).

You can use `sin()` and `cos()` to generate and display sine and cosine waves. Listing 7-1 presents the source code for an application that does just this.

*Listing 7-1. Graphing Sine and Cosine Waves*

```
public class Graph
{
    final static int ROWS = 11; // Must be odd
    final static int COLS = 23;

    public static void main(String[] args)
    {
        char[][] screen = new char[ROWS][COLS];
        for (int row = 0; row < screen.length; row++)
            for (int col = 0; col < screen[0].length; col++)
                screen[row][col] = ' ';
        double scaleX = COLS / 360.0;
```



```

for (int degree = 0; degree < 360; degree++)
{
    int row = ROWS / 2 +
        (int) Math.round(ROWS / 2 * Math.sin(Math.toRadians(degree)));
    int col = (int) (degree * scaleX);
    screen[row][col] = 'S';
    row = ROWS / 2 +
        (int) Math.round(ROWS / 2 * Math.cos(Math.toRadians(degree)));
    screen[row][col] = (screen[row][col] == 'S') ? '*' : 'C';
}
for (int row = ROWS - 1; row >= 0; row--)
{
    for (int col = 0; col < COLS; col++)
        System.out.print(screen[row][col]);
    System.out.println();
}
}
}

```

Listing 7-1 introduces a `Graph` class that first declares a pair of constants: `ROWS` and `COLS`. These constants specify the dimensions of an array on which the graphs are generated. `ROWS` must be assigned an odd integer; otherwise, an instance of the `java.lang.ArrayIndexOutOfBoundsException` class is thrown.

**Tip** It's a good idea to use constants wherever possible. The source code is easier to maintain because you only need to change the constant's value in one place instead of having to change each corresponding value throughout the source code.

`Graph` next declares its `main()` method, which first creates a two-dimensional screen array of characters and initializes this array to spaces. This array is used to simulate an old-style character-based screen for viewing the graphs.

`main()` next calculates a horizontal scale value for scaling each graph horizontally so that 360 horizontal (degree) positions fit into the number of columns specified by `COLS`.

Continuing, `main()` enters a for loop that, for each of the sine and cosine graphs, creates (row, column) coordinates for each degree value, and assigns a character to the screen array at those coordinates. The character is `S` for the sine graph, `C` for the cosine graph, and `*` when the cosine graph intersects the sine graph.

The row calculation invokes `toRadians()` to convert its degree argument to radians, which is required by the `sin()` and `cos()` methods. The value returned from `sin()` or `cos()` (-1.0 to 1.0) is then multiplied by `ROWS / 2` to scale this value to half the number of rows in the screen array. After rounding the result to the nearest long integer via the long `round(double d)` method, a cast is used to convert from long integer to integer, and this integer is added to `ROWS / 2` to offset the row coordinate so that it's relative to the array's middle row. The column calculation is simpler, multiplying the degree value by the horizontal scale factor.

The screen array is dumped to the standard output device via a pair of nested `for` loops. The outer `for` loop reverses the array output so that it appears right side up—row number 0 should output last.

Compile Listing 7-1 (`javac Graph.java`) and run the application (`java Graph`). You will observe the following output:

```
CC SSSS          CC
 CSSS SS        CC
 S*C  SS        CC
 S CC  SS       CC
SS CC  SS       CC
S  CC  S  CC  S
      C  SS  C  SS
      CC  SS CC  S
      CC  SCC  SS
      CC  CSS  SSS
      CCCC SSSS
```

Table 7-1 also reveals some curiosities beginning with `+infinity`, `-infinity`, `+0.0`, `-0.0`, and `NaN` (Not a Number).

Java's floating-point calculations are capable of returning `+infinity`, `-infinity`, `+0.0`, `-0.0`, and `NaN` because Java largely conforms to IEEE 754 ([http://en.wikipedia.org/wiki/IEEE\\_754](http://en.wikipedia.org/wiki/IEEE_754)), a standard for floating-point calculations. The following are the circumstances under which these special values arise:

- `+infinity` returns from attempting to divide a positive number by 0.0. For example, `System.out.println(1.0 / 0.0)`; outputs `Infinity`.
- `-infinity` returns from attempting to divide a negative number by 0.0. For example, `System.out.println(-1.0 / 0.0)`; outputs `-Infinity`.
- `NaN` returns from attempting to divide 0.0 by 0.0, attempting to calculate the square root of a negative number, and attempting other strange operations. For example, `System.out.println(0.0 / 0.0)`; and `System.out.println(Math.sqrt(-1.0))`; each output `NaN`.
- `+0.0` results from attempting to divide a positive number by `+infinity`. For example, `System.out.println(1.0 / (1.0 / 0.0))`; outputs `0.0` (`+0.0` without the `+` sign).
- `-0.0` results from attempting to divide a negative number by `+infinity`. For example, `System.out.println(-1.0 / (1.0 / 0.0))`; outputs `-0.0`.

After an operation yields `+infinity`, `-infinity`, or `NaN`, the rest of the expression usually equals that special value. For example, `System.out.println(1.0 / 0.0 * 20.0)`; outputs `Infinity`. Also, an expression that first yields `+infinity` or `-infinity` might devolve into `NaN`. For example, expression `1.0 / 0.0 * 0.0` first yields `+infinity` (`1.0 / 0.0`) and then yields `NaN` (`+infinity * 0.0`).

Another curiosity is `Integer.MAX_VALUE`, `Integer.MIN_VALUE`, `Long.MAX_VALUE`, and `Long.MIN_VALUE`. Each of these constants identifies the maximum or minimum value that can be represented by the class's associated primitive type. (You'll learn more about these classes later in this chapter.)

Finally, you might wonder why the `abs()`, `max()`, and `min()` overloaded methods don't include byte and short versions, as in `byte abs(byte b)` and `short abs(short s)`. There is no need for these methods because the limited ranges of bytes and short integers make them unsuitable in calculations. If you need such a method, check out Listing 7-2.

*Listing 7-2. Obtaining Absolute Values for Byte Integers and Short Integers*

```
public class AbsByteShort
{
    static byte abs(byte b)
    {
        return (b < 0) ? (byte) -b : b;
    }

    static short abs(short s)
    {
        return (s < 0) ? (short) -s : s;
    }

    public static void main(String[] args)
    {
        byte b = -2;
        System.out.println(abs(b)); // Output: 2
        short s = -3;
        System.out.println(abs(s)); // Output: 3
    }
}
```

Listing 7-2's `(byte)` and `(short)` casts are necessary because `-b` converts `b`'s value from a byte to an `int`, and `-s` converts `s`'s value from a short to an `int`. In contrast, these casts are not needed with `(b < 0)` and `(s < 0)`, which automatically cast `b`'s and `s`'s values to an `int` before comparing them with `int`-based 0.

**Note** Their absence from `Math` suggests that `byte` and `short` are not very useful in method declarations. However, these types are useful when declaring arrays whose elements store small values (such as a binary file's byte values). If you declared an array of `int` or `long` to store such values, you would end up wasting heap space (and might even run out of memory).

## StrictMath and strictfp

While searching through the `java.lang` package documentation, you will probably encounter a class named `StrictMath`. Apart from a longer name, this class appears to be identical to `Math`. The differences between these classes can be summed up as follows:

- `StrictMath`'s methods return exactly the same results on all platforms. In contrast, some of `Math`'s methods might return values that vary ever so slightly from platform to platform.
- Because `StrictMath` cannot utilize platform-specific features such as an extended-precision math coprocessor, an implementation of `StrictMath` might be less efficient than an implementation of `Math`.

For the most part, `Math`'s methods call their `StrictMath` counterparts. Two exceptions are `toDegrees()` and `toRadians()`. Although these methods have identical code bodies in both classes, `StrictMath`'s implementations include reserved word `strictfp` in the method headers:

```
public static strictfp double toDegrees(double angrad)
public static strictfp double toRadians(double angdeg)
```

Wikipedia's "strictfp" entry (<http://en.wikipedia.org/wiki/Strictfp>) mentions that `strictfp` restricts floating-point calculations to ensure portability. This reserved word accomplishes portability in the context of intermediate floating-point representations and overflows/underflows (generating a value too large or small to fit a representation).

Without `strictfp`, an intermediate calculation is not limited to the IEEE 754 32-bit and 64-bit floating-point representations that Java supports. Instead, the calculation can take advantage of a larger representation (perhaps 128 bits) on a platform that supports this representation.

An intermediate calculation that overflows or underflows when its value is represented in 32/64 bits might not overflow/underflow when its value is represented in more bits. Because of this discrepancy, portability is compromised. `strictfp` levels the playing field by requiring all platforms to use 32/64 bits for intermediate calculations.

When applied to a method, `strictfp` ensures that all floating-point calculations performed in that method are in strict compliance. However, `strictfp` can be used in a class header declaration (as in `public strictfp class FourierTransform`) to ensure that all floating-point calculations performed in that class are strict.

**Note** `Math` and `StrictMath` are declared `final` so that they cannot be extended. Also, they declare private empty noargument constructors so that they cannot be instantiated. Finally, `Math` and `StrictMath` are examples of *utility classes* because they exist as placeholders for utility constants and utility (static) methods.

## Exploring Number and Its Children

The abstract `java.lang.Number` class is the superclass of those classes representing numeric values that are convertible to the byte integer, double precision floating-point, floating-point, integer, long integer, and short integer primitive types. This class offers the following conversion methods:

- `byte byteValue()`
- `double doubleValue()`
- `float floatValue()`
- `int intValue()`
- `long longValue()`
- `short shortValue()`

You typically don't work with `Number` directly, unless you've created a collection or array of `Number` subclass objects and plan to iterate over this collection/array, calling one of the conversion methods on each stored instance. Instead, you would typically work with one of the following subclasses:

- `java.util.concurrent.atomic.AtomicInteger`
- `java.util.concurrent.atomic.AtomicLong`
- `java.math.BigDecimal`
- `java.math.BigInteger`
- `java.lang.Byte`
- `java.lang.Double`
- `java.lang.Float`
- `java.lang.Integer`
- `java.lang.Long`
- `java.lang.Short`

I'll shortly discuss all of these types except for `AtomicInteger` and `AtomicLong`, which I'll discuss in Chapter 10.

### BigDecimal

In Chapter 3, I introduced a `SavingsAccount` class with a `balance` field of type `int`. This field records the number of dollars in this account. Alternatively, it could represent the number of pennies that the account contains.

Perhaps you are wondering why I didn't declare `balance` to be of type `double` or `float`. That way, `balance` could store values such as 18.26 (18 dollars in the whole number part and 26 pennies in the fraction part). I didn't declare `balance` to be a `double` or `float` for the following reasons:

- Not all floating-point values that can represent monetary amounts (dollars and cents) can be stored exactly in memory. For example, 0.1 (which you might use to represent 10 cents), has no exact storage representation. If you executed `double total = 0.1; for (int i = 0; i < 50; i++) total += 0.1; System.out.println(total);`, you would observe 5.099999999999998 instead of the correct 5.1 as the output.
- The result of each floating-point calculation needs to be rounded to the nearest cent. Failure to do so introduces tiny errors that can cause the final result to differ from the correct result. Although `Math` supplies a pair of `round()` methods that you might consider using to round a calculation to the nearest cent, these methods round to the nearest integer (dollar).

Listing 7-3's `InvoiceCalc` application demonstrates both problems. However, the first problem isn't serious because it contributes very little to the inaccuracy. The more serious problem occurs from failing to round to the nearest cent after performing a calculation.

*Listing 7-3. Floating-Point-Based Invoice Calculations Leading to Confusing Results*

```
import java.text.NumberFormat;

public class InvoiceCalc
{
    final static double DISCOUNT_PERCENT = 0.1; // 10%
    final static double TAX_PERCENT = 0.05; // 5%

    public static void main(String[] args)
    {
        double invoiceSubtotal = 285.36;
        double discount = invoiceSubtotal * DISCOUNT_PERCENT;
        double subtotalBeforeTax = invoiceSubtotal - discount;
        double salesTax = subtotalBeforeTax * TAX_PERCENT;
        double invoiceTotal = subtotalBeforeTax + salesTax;
        NumberFormat currencyFormat = NumberFormat.getCurrencyInstance();
        System.out.println("Subtotal: " + currencyFormat.format(invoiceSubtotal));
        System.out.println("Discount: " + currencyFormat.format(discount));
        System.out.println("SubTotal after discount: " +
            currencyFormat.format(subtotalBeforeTax));
        System.out.println("Sales Tax: " + currencyFormat.format(salesTax));
        System.out.println("Total: " + currencyFormat.format(invoiceTotal));
    }
}
```

Listing 7-3 performs several invoice-related calculations that result in an incorrect final total. After performing these calculations, it obtains a currency-based formatter for formatting double precision floating-point values into string-based monetary amounts with a currency symbol (such as the dollar sign [\$]). The formatter is obtained by calling the `java.text.NumberFormat` class's `NumberFormat`

`getCurrencyInstance()` method (see Chapter 16). A value is then formatted into a currency string by passing this value as an argument to `NumberFormat`'s `String format(double value)` method.

When you run `InvoiceCalc`, you will discover the following output:

```
Subtotal: $285.36
Discount: $28.54
SubTotal after discount: $256.82
Sales Tax: $12.84
Total: $269.67
```

This output reveals the correct subtotal, discount, subtotal after discount, and sales tax. In contrast, it incorrectly gives 269.67 instead of 269.66 as the final total. The customer will probably not appreciate paying an extra penny, even though 269.67 is the correct value according to the floating-point calculations:

```
Subtotal: 285.36
Discount: 28.536
SubTotal after discount: 256.824
Sales Tax: 12.8412
Total: 269.6652
```

The problem arises from not rounding the result of each calculation to the nearest cent before performing the next calculation. As a result, the 0.024 in 256.824 and 0.0012 in 12.84 contribute to the final value, causing `NumberFormat`'s `format()` method to round this value to 269.67.

**Caution** Never use `float` or `double` to represent monetary values.

Java provides a solution to both problems in the form of a `BigDecimal` class. This immutable class (a `BigDecimal` instance cannot be modified) represents a signed decimal number (such as 23.653) of arbitrary *precision* (number of digits) with an associated *scale* (an integer that specifies the number of digits after the decimal point).

`BigDecimal` declares three convenience constants: `ONE`, `TEN`, and `ZERO`. Each constant is the `BigDecimal` equivalent of 1, 10, and 0 with a zero scale.

**Caution** `BigDecimal` declares several `ROUND_`-prefixed constants. These constants are largely obsolete and should be avoided, along with the public `BigDecimal divide(BigDecimal divisor, int scale, int roundingMode)` and public `BigDecimal setScale(int newScale, int roundingMode)` methods, which are still present so that dependent legacy code continues to compile.

`BigDecimal` also declares a variety of useful constructors and methods. A few of these constructors and methods are described in Table 7-2.

**Table 7-2.** *BigDecimal Constructors and Methods*

Method	Description
<code>BigDecimal(int val)</code>	Initializes the <code>BigDecimal</code> instance to <code>val</code> 's digits. Sets the scale to 0.
<code>BigDecimal(String val)</code>	Initializes the <code>BigDecimal</code> instance to the decimal equivalent of <code>val</code> . Sets the scale to the number of digits after the decimal point or 0 when no decimal point is specified. This constructor throws <code>java.lang.NullPointerException</code> when <code>val</code> is null and <code>java.lang.NumberFormatException</code> when <code>val</code> 's string representation is invalid (contains letters, for example).
<code>BigDecimal abs()</code>	Returns a new <code>BigDecimal</code> instance that contains the absolute value of the current instance's value. The resulting scale is the same as the current instance's scale.
<code>BigDecimal add(BigDecimal augend)</code>	Returns a new <code>BigDecimal</code> instance that contains the sum of the current value and the argument value. The resulting scale is the maximum of the current and argument scales. This method throws <code>NullPointerException</code> when <code>augend</code> is null.
<code>BigDecimal divide(BigDecimal divisor)</code>	Returns a new <code>BigDecimal</code> instance that contains the quotient of the current value divided by the argument value. The resulting scale is the difference of the current and argument scales. It might be adjusted when the result requires more digits. This method throws <code>NullPointerException</code> when <code>divisor</code> is null or <code>java.lang.ArithmeticException</code> when <code>divisor</code> represents 0 or the result cannot be represented exactly.
<code>BigDecimal max(BigDecimal val)</code>	Returns either <code>this</code> or <code>val</code> , whichever <code>BigDecimal</code> instance contains the larger value. This method throws <code>NullPointerException</code> when <code>val</code> is null.
<code>BigDecimal min(BigDecimal val)</code>	Returns either <code>this</code> or <code>val</code> , whichever <code>BigDecimal</code> instance contains the smaller value. This method throws <code>NullPointerException</code> when <code>val</code> is null.
<code>BigDecimal multiply(BigDecimal multiplicand)</code>	Returns a new <code>BigDecimal</code> instance that contains the product of the current value and the argument value. The resulting scale is the sum of the current and argument scales. This method throws <code>NullPointerException</code> when <code>multiplicand</code> is null.
<code>BigDecimal negate()</code>	Returns a new <code>BigDecimal</code> instance that contains the negative of the current value. The resulting scale is the same as the current scale.
<code>int precision()</code>	Returns the precision of the current <code>BigDecimal</code> instance.
<code>BigDecimal remainder(BigDecimal divisor)</code>	Returns a new <code>BigDecimal</code> instance that contains the remainder of the current value divided by the argument value. The resulting scale is the difference of the current scale and the argument scale. It might be adjusted when the result requires more digits. This method throws <code>NullPointerException</code> when <code>divisor</code> is null or <code>ArithmeticException</code> when <code>divisor</code> represents 0.
<code>int scale()</code>	Returns the scale of the current <code>BigDecimal</code> instance.

*(continued)*



**Table 7-2.** (continued)

Method	Description
<code>BigDecimal setScale(int newScale, RoundingMode roundingMode)</code>	Returns a new <code>BigDecimal</code> instance with the specified scale and rounding mode. If the new scale is greater than the old scale, additional zeros are added to the unscaled value. In this case, no rounding is necessary. If the new scale is smaller than the old scale, trailing digits are removed. If these trailing digits are not zero, the remaining unscaled value has to be rounded. For this rounding operation, the specified rounding mode is used. This method throws <code>NullPointerException</code> when <code>roundingMode</code> is null, and <code>ArithmeticException</code> when <code>roundingMode</code> is set to <code>RoundingMode.ROUND_UNNECESSARY</code> but rounding is necessary based on the current scale.
<code>BigDecimal subtract(BigDecimal subtrahend)</code>	Returns a new <code>BigDecimal</code> instance that contains the current value minus the argument value. The resulting scale is the maximum of the current and argument scales. This method throws <code>NullPointerException</code> when <code>subtrahend</code> is null.
<code>String toString()</code>	Returns a string representation of this <code>BigDecimal</code> instance. Scientific notation is used when necessary.

Table 7-2 refers to `java.math.RoundingMode`, which is an enum containing various rounding mode constants. These constants are described in Table 7-3.

**Table 7-3.** *RoundingMode Constants*

Constant	Description
<code>CEILING</code>	Rounds toward positive infinity.
<code>DOWN</code>	Rounds toward zero.
<code>FLOOR</code>	Rounds toward negative infinity.
<code>HALF_DOWN</code>	Rounds toward the “nearest neighbor” unless both neighbors are equidistant, in which case rounds down.
<code>HALF_EVEN</code>	Rounds toward the “nearest neighbor” unless both neighbors are equidistant, in which case rounds toward the even neighbor.
<code>HALF_UP</code>	Rounds toward the “nearest neighbor” unless both neighbors are equidistant, in which case rounds up. (This is the rounding mode commonly taught at school.)
<code>UNNECESSARY</code>	Rounding isn’t necessary because the requested operation produces the exact result.
<code>UP</code>	Positive values are rounded toward positive infinity and negative values are rounded toward negative infinity.

The best way to get comfortable with `BigDecimal` is to try it out. Listing 7-4 uses this class to correctly perform the invoice calculations that were presented in Listing 7-3.

*Listing 7-4. BigDecimal-Based Invoice Calculations Not Leading to Confusing Results*

```
import java.math.BigDecimal;
import java.math.RoundingMode;

public class InvoiceCalc
{
    public static void main(String[] args)
    {
        BigDecimal invoiceSubtotal = new BigDecimal("285.36");
        BigDecimal discountPercent = new BigDecimal("0.10");
        BigDecimal discount = invoiceSubtotal.multiply(discountPercent);
        discount = discount.setScale(2, RoundingMode.HALF_UP);
        BigDecimal subtotalBeforeTax = invoiceSubtotal.subtract(discount);
        subtotalBeforeTax = subtotalBeforeTax.setScale(2, RoundingMode.HALF_UP);
        BigDecimal salesTaxPercent = new BigDecimal("0.05");
        BigDecimal salesTax = subtotalBeforeTax.multiply(salesTaxPercent);
        salesTax = salesTax.setScale(2, RoundingMode.HALF_UP);
        BigDecimal invoiceTotal = subtotalBeforeTax.add(salesTax);
        invoiceTotal = invoiceTotal.setScale(2, RoundingMode.HALF_UP);
        System.out.println("Subtotal: " + invoiceSubtotal);
        System.out.println("Discount: " + discount);
        System.out.println("SubTotal after discount: " + subtotalBeforeTax);
        System.out.println("Sales Tax: " + salesTax);
        System.out.println("Total: " + invoiceTotal);
    }
}
```

Listing 7-4's `main()` method first creates `BigDecimal` objects `invoiceSubtotal` and `discountPercent` that are initialized to 285.36 and 0.10, respectively. It multiplies `invoiceSubtotal` by `discountPercent` and assigns the `BigDecimal` result to `discount`.

At this point, `discount` contains 28.5360. Apart from the trailing zero, this value is the same as that generated by `invoiceSubtotal * DISCOUNT_PERCENT` in Listing 7-3. The value that should be stored in `discount` is 28.54. To correct this problem before performing another calculation, `main()` calls `discount`'s `setScale()` method with these arguments:

- 2: Two digits after the decimal point
- `RoundingMode.HALF_UP`: The conventional approach to rounding

After setting the scale and proper rounding mode, `main()` subtracts `discount` from `invoiceSubtotal` and assigns the resulting `BigDecimal` instance to `subtotalBeforeTax`. `main()` calls `setScale()` on `subtotalBeforeTax` to properly round its value before moving on to the next calculation.

`main()` next creates a `BigDecimal` object named `salesTaxPercent` that is initialized to 0.05. It then multiplies `subtotalBeforeTax` by `salesTaxPercent`, assigning the result to `salesTax`, and calls `setScale()` on this `BigDecimal` object to properly round its value.

Moving on, `main()` adds `salesTax` to `subtotalBeforeTax`, saving the result in `invoiceTotal`, and rounds the result via `setScale()`. The values in these objects are sent to the standard output device via `System.out.println()`, which calls their `toString()` methods to return string representations of the `BigDecimal` values.

When you run this new version of InvoiceCalc, you will discover the following output:

```
Subtotal: 285.36
Discount: 28.54
SubTotal after discount: 256.82
Sales Tax: 12.84
Total: 269.66
```

**Caution** `BigDecimal` declares a `BigDecimal(double val)` constructor that you should avoid using if at all possible. This constructor initializes the `BigDecimal` instance to the value stored in `val`, making it possible for this instance to reflect an invalid representation when the `double` cannot be stored exactly. For example, `BigDecimal(0.1)` results in `0.1000000000000000055511151231257827021181583404541015625` being stored in the instance. In contrast, `BigDecimal("0.1")` stores `0.1` exactly.

## BigInteger

`BigDecimal` stores a signed decimal number as an unscaled value with a 32-bit integer scale. The unscaled value is stored in an instance of the `BigInteger` class.

`BigInteger` is an immutable class that represents a signed integer of arbitrary precision. It stores its value in *two's complement format* (all bits are flipped—1s to 0s and 0s to 1s—and 1 is added to the result to be compatible with the two's complement format used by Java's byte integer, short integer, integer, and long integer types).

**Note** Check out Wikipedia's "Two's complement" entry ([http://en.wikipedia.org/wiki/Two's\\_complement](http://en.wikipedia.org/wiki/Two's_complement)) to learn more about two's complement.

`BigInteger` declares three convenience constants: `ONE`, `TEN`, and `ZERO`. Each constant is the `BigInteger` equivalent of 1, 10, and 0.

`BigInteger` also declares a variety of useful constructors and methods. A few of these constructors and methods are described in Table 7-4.

**Table 7-4.** *BigInteger Constructors and Methods*

Method	Description
<code>BigInteger(byte[] val)</code>	Initializes the <code>BigInteger</code> instance to the integer that is stored in the <code>val</code> array, with <code>val[0]</code> storing the integer's most significant (leftmost) 8 bits. This constructor throws <code>NullPointerException</code> when <code>val</code> is null and <code>NumberFormatException</code> when <code>val.length</code> equals 0.
<code>BigInteger(String val)</code>	Initializes the <code>BigInteger</code> instance to the integer equivalent of <code>val</code> . This constructor throws <code>NullPointerException</code> when <code>val</code> is null and <code>NumberFormatException</code> when <code>val</code> 's string representation is invalid (contains letters, for example).
<code>BigInteger abs()</code>	Returns a new <code>BigInteger</code> instance that contains the absolute value of the current instance's value.
<code>BigInteger add(BigInteger augend)</code>	Returns a new <code>BigInteger</code> instance that contains the sum of the current value and the argument value. This method throws <code>NullPointerException</code> when <code>augend</code> is null.
<code>BigInteger divide(BigInteger divisor)</code>	Returns a new <code>BigInteger</code> instance that contains the quotient of the current value divided by the argument value. This method throws <code>NullPointerException</code> when <code>divisor</code> is null and <code>ArithmeticException</code> when <code>divisor</code> represents 0 or the result cannot be represented exactly.
<code>BigInteger max(BigInteger val)</code>	Returns either <code>this</code> or <code>val</code> , whichever <code>BigInteger</code> instance contains the larger value. This method throws <code>NullPointerException</code> when <code>val</code> is null.
<code>BigInteger min(BigInteger val)</code>	Returns either <code>this</code> or <code>val</code> , whichever <code>BigInteger</code> instance contains the smaller value. This method throws <code>NullPointerException</code> when <code>val</code> is null.
<code>BigInteger multiply(BigInteger multiplicand)</code>	Returns a new <code>BigInteger</code> instance that contains the product of the current value and the argument value. This method throws <code>NullPointerException</code> when <code>multiplicand</code> is null.
<code>BigInteger negate()</code>	Returns a new <code>BigInteger</code> instance that contains the negative of the current value.
<code>BigInteger remainder(BigInteger divisor)</code>	Returns a new <code>BigInteger</code> instance that contains the remainder of the current value divided by the argument value. This method throws <code>NullPointerException</code> when <code>divisor</code> is null and <code>ArithmeticException</code> when <code>divisor</code> represents 0.
<code>BigInteger subtract(BigInteger subtrahend)</code>	Returns a new <code>BigInteger</code> instance that contains the current value minus the argument value. This method throws <code>NullPointerException</code> when <code>subtrahend</code> is null.
<code>String toString()</code>	Returns a string representation of this <code>BigInteger</code> instance.

**Note** `BigInteger` also declares several bit-oriented methods, such as `BigInteger and(BigInteger val)`, `BigInteger flipBit(int n)`, and `BigInteger shiftLeft(int n)`. These methods are useful for when you need to perform low-level bit manipulation.

The best way to get comfortable with `BigInteger` is to try it out. Listing 7-5 uses this class in a `factorial()` method comparison context.

*Listing 7-5. Comparing factorial() Methods*

```
import java.math.BigInteger;

public class FactComp
{
    public static void main(String[] args)
    {
        System.out.println(factorial(12));
        System.out.println();
        System.out.println(factorial(20L));
        System.out.println();
        System.out.println(factorial(170.0));
        System.out.println();
        System.out.println(factorial(new BigInteger("170")));
        System.out.println();
        System.out.println(factorial(25.0));
        System.out.println();
        System.out.println(factorial(new BigInteger("25")));
    }

    static int factorial(int n)
    {
        if (n == 0)
            return 1;
        else
            return n * factorial(n - 1);
    }

    static long factorial(long n)
    {
        if (n == 0)
            return 1;
        else
            return n * factorial(n - 1);
    }

    static double factorial(double n)
    {
        if (n == 1.0)
            return 1.0;
    }
}
```



The first three values represent the highest factorials that can be returned by the `int`-based, `long`-based, and `double`-based `factorial()` methods. The fourth value represents the `BigInteger` equivalent of the highest `double` factorial.

Notice that the `double` method fails to accurately represent  $170!$  (! is the math symbol for factorial). Its precision is simply too small. Although the method attempts to round the smallest digit, rounding doesn't always work—the number ends in 7994 instead of 7998. Rounding is only accurate up to argument 25.0, as the last two output lines reveal.

**Note** RSA encryption ([http://en.wikipedia.org/wiki/RSA\\_\(algorithm\)](http://en.wikipedia.org/wiki/RSA_(algorithm))) offers another use for `BigInteger`.

## Primitive Type Wrapper Classes

`Byte`, `Double`, `Float`, `Integer`, `Long`, and `Short` along with `Boolean` and `Character` are known as *primitive type wrapper classes* or *value classes* because their instances wrap themselves around values of primitive types. Java provides these eight primitive type wrapper classes for two reasons:

- The Collections Framework (discussed in Chapter 9) provides lists, sets, and maps that can only store objects; they cannot store primitive-type values. You store a primitive-type value in a primitive type wrapper class instance and store the instance in the collection.
- These classes provide a good place to associate useful constants (such as `MAX_VALUE` and `MIN_VALUE`) and class methods (such as `Integer`'s `parseInt()` methods and `Character`'s `isDigit()`, `isLetter()`, and `toUpperCase()` methods) with the primitive types.

In this section, I will introduce you to each of these primitive type wrapper classes.

### Boolean

`Boolean` is the smallest of the primitive type wrapper classes. This class declares three constants, including `TRUE` and `FALSE`, which denote precreated `Boolean` objects. It also declares a pair of constructors for initializing a `Boolean` object:

- `Boolean(boolean value)` initializes the `Boolean` object to `value`.
- `Boolean(String s)` converts `s`'s text to a `true` or `false` value and stores this value in the `Boolean` object.

The second constructor compares `s`'s value with `true`. Because the comparison is case insensitive, any uppercase/lowercase combination of these four letters (such as `true`, `TRUE`, or `tRuE`) results in `true` being stored in the object. Otherwise, the constructor stores `false` in the object.

**Note** Boolean's constructors are complemented by `boolean booleanValue()`, which returns the wrapped Boolean value.

Boolean also declares or overrides the following methods:

- `int compareTo(Boolean b)` compares the current Boolean object with `b` to determine their relative order. The method returns 0 when the current object contains the same Boolean value as `b`, a positive value when the current object contains `true` and `b` contains `false`, and a negative value when the current object contains `false` and `b` contains `true`.
- `boolean equals(Object o)` compares the current Boolean object with `o` and returns `true` when `o` is not null, `o` is of type `Boolean`, and both objects contain the same Boolean value.
- `static boolean getBoolean(String name)` returns `true` when a system property (discussed later in this chapter) identified by `name` exists and is equal to `true`.
- `int hashCode()` returns a suitable hash code that allows Boolean objects to be used with hash-based collections (discussed in Chapter 9).
- `static boolean parseBoolean(String s)` parses `s`, returning `true` when `s` equals `"true"`, `"TRUE"`, `"True"`, or any other uppercase/lowercase combination. Otherwise, this method returns `false`. (*Parsing* breaks a sequence of characters into meaningful components, known as *tokens*.)
- `String toString()` returns `"true"` when the current Boolean instance contains `true`; otherwise, this method returns `"false"`.
- `static String toString(boolean b)` returns `"true"` when `b` contains `true`; otherwise, this method returns `"false"`.
- `static Boolean valueOf(boolean b)` returns `TRUE` when `b` contains `true` or `FALSE` when `b` contains `false`.
- `static Boolean valueOf(String s)` returns `TRUE` when `s` equals `"true"`, `"TRUE"`, `"True"`, or any other uppercase/lowercase combination. Otherwise, this method returns `FALSE`.

**Caution** Newcomers to the Boolean class often think that `getBoolean()` returns a Boolean object's true/false value. However, `getBoolean()` returns the value of a Boolean-based system property. I will discuss system properties later in this chapter. If you need to return a Boolean object's true/false value, use the `booleanValue()` method instead.



It's often better to use `TRUE` and `FALSE` than to create `Boolean` objects. For example, consider a method that returns a `Boolean` object containing `true` when the method's `double` argument is negative or `false` when this argument is zero or positive. You might declare your method like the following `isNegative()` method:

```
Boolean isNegative(double d)
{
    return new Boolean(d < 0);
}
```

Although this method is concise, it unnecessarily creates a `Boolean` object. When the method is called frequently, many `Boolean` objects are created that consume heap space. When heap space runs low, the garbage collector runs and slows down the application, which impacts performance.

The following example reveals a better way to code `isNegative()`:

```
Boolean isNegative(double d)
{
    return (d < 0) ? Boolean.TRUE : Boolean.FALSE;
}
```

This method avoids creating `Boolean` objects by returning either the precreated `TRUE` or `FALSE` object.

**Tip** You should strive to create as few objects as possible. Not only will your applications have smaller memory footprints, they'll perform better because the garbage collector will not run as often.

## Character

`Character` is the largest of the primitive type wrapper classes, containing many constants, a constructor, many methods, and a pair of nested classes (`Subset` and `UnicodeBlock`).

**Note** `Character`'s complexity derives from Java's support for Unicode (<http://en.wikipedia.org/wiki/Unicode>). For brevity, I ignore much of `Character`'s Unicode-related complexity, which is beyond the scope of this chapter.

`Character` declares a single `Character(char value)` constructor, which you use to initialize a `Character` object to `value`. This constructor is complemented by `char charValue()`, which returns the wrapped character value.

When you start writing applications, you might codify expressions such as `ch >= '0' && ch <= '9'` (test `ch` to see if it contains a digit) and `ch >= 'A' && ch <= 'Z'` (test `ch` to see if it contains an uppercase letter). You should avoid doing so for three reasons:

- It's too easy to introduce a bug into the expression. For example, `ch > '0' && ch <= '9'` introduces a subtle bug that doesn't include '0' in the comparison.
- The expressions are not very descriptive of what they are testing.
- The expressions are biased toward Latin digits (0–9) and letters (A–Z and a–z). They don't take into account digits and letters that are valid in other languages. For example, `'\u00b9'` is a character literal representing one of the digits in the Tamil language.

`Character` declares several comparison and conversion class methods that address these concerns. These methods include the following:

- `static boolean isDigit(char ch)` returns true when `ch` contains a digit (typically 0 through 9 but also digits in other alphabets).
- `static boolean isLetter(char ch)` returns true when `ch` contains a letter (typically A–Z or a–z but also letters in other alphabets).
- `static boolean isLetterOrDigit(char ch)` returns true when `ch` contains a letter or digit (typically A–Z, a–z, or 0–9 but also letters or digits in other alphabets).
- `static boolean isLowerCase(char ch)` returns true when `ch` contains a lowercase letter.
- `static boolean isUpperCase(char ch)` returns true when `ch` contains an uppercase letter.
- `static boolean isWhitespace(char ch)` returns true when `ch` contains a whitespace character (typically a space, a horizontal tab, a carriage return, or a line feed).
- `static char toLowerCase(char ch)` returns the lowercase equivalent of `ch`'s uppercase letter; otherwise, this method returns `ch`'s value.
- `static char toUpperCase(char ch)` returns the uppercase equivalent of `ch`'s lowercase letter; otherwise, this method returns `ch`'s value.

For example, `isDigit(ch)` is preferable to `ch >= '0' && ch <= '9'` because it avoids a source of bugs, is more readable, and returns true for non-Latin digits (such as `'\u00b9'`) and Latin digits.

## Float and Double

`Float` and `Double` store floating-point and double precision floating-point values in `Float` and `Double` objects, respectively. These classes declare the following constants:

- `MAX_VALUE` identifies the maximum value that can be represented as a `float` or `double`.
- `MIN_VALUE` identifies the minimum value that can be represented as a `float` or `double`.

- NaN represents 0.0F / 0.0F as a float and 0.0 / 0.0 as a double.
- NEGATIVE\_INFINITY represents -infinity as a float or double.
- POSITIVE\_INFINITY represents +infinity as a float or double.

Float and Double also declare the following constructors for initializing their objects:

- Float(float value) initializes the Float object to value.
- Float(double value) initializes the Float object to the float equivalent of value.
- Float(String s) converts s's text to a floating-point value and stores this value in the Float object.
- Double(double value) initializes the Double object to value.
- Double(String s) converts s's text to a double precision floating-point value and stores this value in the Double object.

Float's constructors are complemented by float floatValue(), which returns the wrapped floating-point value. Similarly, Double's constructors are complemented by double doubleValue(), which returns the wrapped double precision floating-point value.

Float declares several utility methods in addition to floatValue(). These methods include the following:

- static int floatToIntBits(float value) converts value to a 32-bit integer.
- static boolean isInfinite(float f) returns true when f's value is +infinity or -infinity. A related boolean isInfinite() method returns true when the current Float object's value is +infinity or -infinity.
- static boolean isNaN(float f) returns true when f's value is NaN. A related boolean isNaN() method returns true when the current Float object's value is NaN.
- static float parseFloat(String s) parses s, returning the floating-point equivalent of s's textual representation of a floating-point value or throwing NumberFormatException when this representation is invalid (contains letters, for example).

Double declares several utility methods as well as doubleValue(). These methods include the following:

- static long doubleToLongBits(double value) converts value to a long integer.
- static boolean isInfinite(double d) returns true when d's value is +infinity or -infinity. A related boolean isInfinite() method returns true when the current Double object's value is +infinity or -infinity.
- static boolean isNaN(double d) returns true when d's value is NaN. A related public boolean isNaN() method returns true when the current Double object's value is NaN.
- static double parseDouble(String s) parses s, returning the double precision floating-point equivalent of s's textual representation of a double precision floating-point value or throwing NumberFormatException when this representation is invalid.

The `floatToIntBits()` and `doubleToIntBits()` methods are used in implementations of the `equals()` and `hashCode()` methods that must take `float` and `double` fields into account. `floatToIntBits()` and `doubleToIntBits()` allow `equals()` and `hashCode()` to respond properly to the following situations:

- `equals()` must return `true` when `f1` and `f2` contain `Float.NaN` (or `d1` and `d2` contain `Double.NaN`). If `equals()` was implemented in a manner similar to `f1.floatValue() == f2.floatValue()` (or `d1.doubleValue() == d2.doubleValue()`), this method would return `false` because `NaN` is not equal to anything, including itself.
- `equals()` must return `false` when `f1` contains `+0.0` and `f2` contains `-0.0` (or vice versa), or `d1` contains `+0.0` and `d2` contains `-0.0` (or vice versa). If `equals()` was implemented in a manner similar to `f1.floatValue() == f2.floatValue()` (or `d1.doubleValue() == d2.doubleValue()`), this method would return `true` because `+0.0 == -0.0` returns `true`.

These requirements are needed for hash-based collections (discussed in Chapter 9) to work properly. Listing 7-6 shows how they impact `Float`'s and `Double`'s `equals()` methods.

*Listing 7-6. Demonstrating `Float`'s `equals()` Method in a `NaN` Context and `Double`'s `equals()` Method in a `+/-0.0` Context*

```
public class FloatDoubleDemo
{
    public static void main(String[] args)
    {
        Float f1 = new Float(Float.NaN);
        System.out.println(f1.floatValue());
        Float f2 = new Float(Float.NaN);
        System.out.println(f2.floatValue());
        System.out.println(f1.equals(f2));
        System.out.println(Float.NaN == Float.NaN);
        System.out.println();
        Double d1 = new Double(+0.0);
        System.out.println(d1.doubleValue());
        Double d2 = new Double(-0.0);
        System.out.println(d2.doubleValue());
        System.out.println(d1.equals(d2));
        System.out.println(+0.0 == -0.0);
    }
}
```

Compile Listing 7-6 (`javac FloatDoubleDemo.java`) and run this application (`java FloatDoubleDemo`). The following output proves that `Float`'s `equals()` method properly handles `NaN` and `Double`'s `equals()` method properly handles `+/-0.0`:

```
NaN
NaN
true
false
```

```
0.0
-0.0
false
true
```

**Tip** When you want to test a float or double value for equality with +infinity or -infinity (but not both), don't use `isInfinite()`. Instead, compare the value with `NEGATIVE_INFINITY` or `POSITIVE_INFINITY` via `==`. For example, `f == Float.NEGATIVE_INFINITY`.

You will find `parseFloat()` and `parseDouble()` useful in many contexts. For example, Listing 7-7 uses `parseDouble()` to parse command-line arguments into doubles.

*Listing 7-7. Parsing Command-Line Arguments into Double Precision Floating-Point Values*

```
public class Calc
{
    public static void main(String[] args)
    {
        if (args.length != 3)
        {
            System.err.println("usage: java Calc value1 op value2");
            System.err.println("op is one of +, -, x, or /");
            return;
        }
        try
        {
            double value1 = Double.parseDouble(args[0]);
            double value2 = Double.parseDouble(args[2]);
            if (args[1].equals("+"))
                System.out.println(value1 + value2);
            else
            if (args[1].equals("-"))
                System.out.println(value1 - value2);
            else
            if (args[1].equals("x"))
                System.out.println(value1 * value2);
            else
            if (args[1].equals("/"))
                System.out.println(value1 / value2);
            else
                System.err.println("invalid operator: " + args[1]);
        }
    }
}
```

```

    catch (NumberFormatException nfe)
    {
        System.err.println("Bad number format: " + nfe.getMessage());
    }
}
}

```

Specify `java Calc 10E+3 + 66.0` to try out the `Calc` application. This application responds by outputting `10066.0`. If you specified `java Calc 10E+3 + A` instead, you would observe `Bad number format: For input string: "A"` as the output, which is in response to the second `parseDouble()` method call's throwing of a `NumberFormatException` object.

Although `NumberFormatException` describes an unchecked exception, and although unchecked exceptions are often not handled because they represent coding mistakes, `NumberFormatException` doesn't fit this pattern in this example. The exception doesn't arise from a coding mistake; it arises from someone passing an illegal numeric argument to the application, which cannot be avoided through proper coding. Perhaps `NumberFormatException` should have been implemented as a checked exception.

## Integer, Long, Short, and Byte

`Integer`, `Long`, `Short`, and `Byte` store 32-bit, 64-bit, 16-bit, and 8-bit integer values in `Integer`, `Long`, `Short`, and `Byte` objects, respectively.

Each class declares `MAX_VALUE` and `MIN_VALUE` constants that identify the maximum and minimum values that can be represented by its associated primitive type. These classes also declare the following constructors for initializing their objects:

- `Integer(int value)` initializes the `Integer` object to `value`.
- `Integer(String s)` converts `s`'s text to a 32-bit integer value and stores this value in the `Integer` object.
- `Long(long value)` initializes the `Long` object to `value`.
- `Long(String s)` converts `s`'s text to a 64-bit integer value and stores this value in the `Long` object.
- `Short(short value)` initializes the `Short` object to `value`.
- `Short(String s)` converts `s`'s text to a 16-bit integer value and stores this value in the `Short` object.
- `Byte(byte value)` initializes the `Byte` object to `value`.
- `Byte(String s)` converts `s`'s text to an 8-bit integer value and stores this value in the `Byte` object.

`Integer`'s constructors are complemented by `int intValue()`, `Long`'s constructors are complemented by `long longValue()`, `Short`'s constructors are complemented by `short shortValue()`, and `Byte`'s constructors are complemented by `byte byteValue()`. These inherited methods return wrapped integers.

These classes declare various useful integer-oriented methods. For example, `Integer` declares the following class methods for converting a 32-bit integer to a `String` according to a specific representation (binary, hexadecimal, octal, and decimal):

- `static String toBinaryString(int i)` returns a `String` object containing `i`'s binary representation. For example, `Integer.toBinaryString(255)` returns a `String` object containing `11111111`.
- `static String toHexString(int i)` returns a `String` object containing `i`'s hexadecimal representation. For example, `Integer.toHexString(255)` returns a `String` object containing `ff`.
- `static String toOctalString(int i)` returns a `String` object containing `i`'s octal representation. For example, `Integer.toOctalString(64)` returns a `String` object containing `100`.
- `static String toString(int i)` returns a `String` object containing `i`'s decimal representation. For example, `Integer.toString(255)` returns a `String` object containing `255`.

It's often convenient to prepend zeros to a binary string so that you can align multiple binary strings in columns. For example, you might want to create an application that displays the following aligned output:

```
11110001
+
00000111
-----
11111000
```

Unfortunately, `Integer.toBinaryString()` doesn't let you accomplish this task. For example, `Integer.toBinaryString(7)` returns a `String` object containing `111` instead of `00000111`. Listing 7-8's `toAlignedBinaryString()` method addresses this oversight.

**Listing 7-8. Aligning Binary Strings**

```
public class AlignBinaryString
{
    public static void main(String[] args)
    {
        System.out.println(toAlignedBinaryString(7, 8));
        System.out.println(toAlignedBinaryString(255, 16));
        System.out.println(toAlignedBinaryString(255, 7));
    }

    static String toAlignedBinaryString(int i, int numBits)
    {
        String result = Integer.toBinaryString(i);
        if (result.length() > numBits)
            return null; // cannot fit result into numBits columns
        int numLeadingZeros = numBits - result.length();
        StringBuilder sb = new StringBuilder();
        for (int j = 0; j < numLeadingZeros; j++)
```

```

        sb.append('0');
    return sb.toString() + result;
}
}

```

The `toAlignedBinaryString()` method takes two arguments: the first argument specifies the 32-bit integer that is to be converted into a binary string, and the second argument specifies the number of bit columns in which to fit the string.

After calling `toBinaryString()` to return `i`'s equivalent binary string without leading zeros, `toAlignedBinaryString()` verifies that the string's digits can fit into the number of bit columns specified by `numBits`. If they don't fit, this method returns `null`.

Moving on, `toAlignedBinaryString()` calculates the number of leading "0"s to prepend to `result` and then uses a `for` loop to create a string of leading zeros. This method ends by returning the leading zeros string prepended to the result string.

When you run this application, it generates the following output:

```

00000111
0000000011111111
null

```

## Exploring String, StringBuffer, and StringBuilder

Many computer languages implement the concept of a *string*, a sequence of characters treated as a single unit (and not as individual characters). For example, the C language implements a string as an array of characters terminated by the null character (`'\0'`). In contrast, Java implements a string via the `java.lang.String` class.

`String` objects are immutable: you cannot modify a `String` object's string. The various `String` methods that appear to modify the `String` object actually return a new `String` object with modified string content instead. Because returning new `String` objects is often wasteful, Java provides the `java.lang.StringBuffer` and equivalent `java.lang.StringBuilder` classes as a workaround.

This section introduces you to `String`, `StringBuffer`, and `StringBuilder`.

### String

`String` represents a string as a sequence of characters. In contrast to strings in the C language, this sequence is not terminated by a null character. Instead, its length is stored separately.

You typically obtain a `String` by assigning a string literal to a variable of `String` type; for example, `String favLanguage = "Java";`. You can also obtain a `String` by calling a `String` constructor; for example, `String favLanguage = new String("Java");`.

After obtaining a `String`, you can invoke methods to accomplish various tasks. For example, you can obtain a string's length by invoking the `length()` method; for example, `favLanguage.length()`.

Table 7-5 describes some of `String`'s constructors and methods for initializing `String` objects and working with strings.



**Table 7-5. String Constructors and Methods**

Method	Description
<code>String(char[] data)</code>	Initializes this <code>String</code> object to the characters in the <code>data</code> array. Modifying <code>data</code> after initializing this <code>String</code> object has no effect on the object.
<code>String(String s)</code>	Initializes this <code>String</code> object to <code>s</code> 's string.
<code>char charAt(int index)</code>	Returns the character located at the zero-based index in this <code>String</code> object's string. Throws <code>java.lang.StringIndexOutOfBoundsException</code> when <code>index</code> is less than 0 or greater than or equal to the length of the string.
<code>String concat(String s)</code>	Returns a new <code>String</code> object containing this <code>String</code> object's string followed by the <code>s</code> argument's string.
<code>boolean endsWith(String suffix)</code>	Returns true when this <code>String</code> object's string ends with the characters in the <code>suffix</code> argument, when <code>suffix</code> is empty (contains no characters), or when <code>suffix</code> contains the same character sequence as this <code>String</code> object's string. This method performs a case-sensitive comparison ( <code>a</code> is not equal to <code>A</code> , for example) and throws <code>NullPointerException</code> when <code>suffix</code> is null.
<code>boolean equals(Object object)</code>	Returns true when <code>object</code> is of type <code>String</code> and this argument's string contains the same characters (and in the same order) as this <code>String</code> object's string.
<code>boolean equalsIgnoreCase(String s)</code>	Returns true when <code>s</code> and this <code>String</code> object contain the same characters (ignoring case). This method returns false when the character sequences differ or when null is passed to <code>s</code> .
<code>int indexOf(int c)</code>	Returns the zero-based index of the first occurrence (from the start of the string to the end of the string) of the character represented by <code>c</code> in this <code>String</code> object's string. Returns -1 when this character is not present.
<code>int indexOf(String s)</code>	Returns the zero-based index of the first occurrence (from the start of the string to the end of the string) of <code>s</code> 's character sequence in this <code>String</code> object's string. Returns -1 when <code>s</code> is not present. Throws <code>NullPointerException</code> when <code>s</code> is null.
<code>String intern()</code>	Searches an internal table of <code>String</code> objects for an object whose string is equal to this <code>String</code> object's string. This <code>String</code> object's string is added to the table when not present. Returns the object contained in the table whose string is equal to this <code>String</code> object's string. The same <code>String</code> object is always returned for strings that are equal.
<code>int lastIndexOf(int c)</code>	Returns the zero-based index of the last occurrence (from the start of the string to the end of the string) of the character represented by <code>c</code> in this <code>String</code> object's string. Returns -1 when this character is not present.
<code>int lastIndexOf(String s)</code>	Returns the zero-based index of the last occurrence (from the start of the string to the end of the string) of <code>s</code> 's character sequence in this <code>String</code> object's string. Returns -1 when <code>s</code> is not present. Throws <code>NullPointerException</code> when <code>s</code> is null.
<code>int length()</code>	Returns the number of characters in this <code>String</code> object's string.

*(continued)*

Table 7-5. (continued)

Method	Description
<code>String replace(char oldChar, char newChar)</code>	Returns a new <code>String</code> object whose string matches this <code>String</code> object's string except that all occurrences of <code>oldChar</code> have been replaced by <code>newChar</code> .
<code>String[] split(String expr)</code>	Splits this <code>String</code> object's string into an array of <code>String</code> objects using the <i>regular expression</i> (a string whose <i>pattern</i> [template] is used to search a string for substrings that match the pattern) specified by <code>expr</code> as the basis for the split. Throws <code>NullPointerException</code> when <code>expr</code> is null and <code>java.util.regex.PatternSyntaxException</code> when <code>expr</code> 's syntax is invalid.
<code>boolean startsWith(String prefix)</code>	Returns true when this <code>String</code> object's string starts with the characters in the <code>prefix</code> argument, when <code>prefix</code> is empty (contains no characters), or when <code>prefix</code> contains the same character sequence as this <code>String</code> object's string. This method performs a case-sensitive comparison (such as <code>a</code> is not equal to <code>A</code> ), and throws <code>NullPointerException</code> when <code>prefix</code> is null.
<code>String substring(int start)</code>	Returns a new <code>String</code> object whose string contains this <code>String</code> object's characters beginning with the character located at <code>start</code> . Throws <code>StringIndexOutOfBoundsException</code> when <code>start</code> is negative or greater than the length of this <code>String</code> object's string.
<code>char[] toCharArray()</code>	Returns a character array that contains the characters in this <code>String</code> object's string.
<code>String toLowerCase()</code>	Returns a new <code>String</code> object whose string contains this <code>String</code> object's characters where uppercase letters have been converted to lowercase. This <code>String</code> object is returned when it contains no uppercase letters to convert.
<code>String toUpperCase()</code>	Returns a new <code>String</code> object whose string contains this <code>String</code> object's characters where lowercase letters have been converted to uppercase. This <code>String</code> object is returned when it contains no lowercase letters to convert.
<code>String trim()</code>	Returns a new <code>String</code> object that contains this <code>String</code> object's string with <i>whitespace characters</i> (characters whose Unicode values are 32 or less) removed from the start and end of the string, or this <code>String</code> object when there is no leading/trailing whitespace.

Table 7-5 reveals a couple of interesting items about `String`. First, this class's `String(String s)` constructor doesn't initialize a `String` object to a string literal, as in `new String("Java")`. Instead, it behaves similarly to the C++ copy constructor by initializing the `String` object to the contents of another `String` object. This behavior suggests that a string literal is more than it appears to be.

In reality, a string literal is a `String` object. You can prove this to yourself by executing `System.out.println("abc".length());` and `System.out.println("abc" instanceof String);`. The first method call outputs 3, which is the length of the "abc" `String` object's string, and the second method call outputs true ("abc" is a `String` object).

**Note** String literals are stored in a classfile data structure known as the *constant pool*. When a class is loaded, a String object is created for each literal and is stored in an internal table of String objects.

The second interesting item is the `intern()` method, which *interns* (stores a unique copy of) a String object in an internal table of String objects. `intern()` makes it possible to compare strings via their references and `==` or `!=`. These operators are the fastest way to compare strings, which is especially valuable when sorting a huge number of strings.

Listing 7-9 demonstrates these concepts.

*Listing 7-9. Demonstrating a Couple of Interesting Things About Strings*

```
public class StringDemo
{
    public static void main(String[] args)
    {
        System.out.println("abc".length());
        System.out.println("abc" instanceof String);
        System.out.println("abc" == "a" + "bc");
        System.out.println("abc" == new String("abc"));
        System.out.println("abc" == new String("abc").intern());
    }
}
```

Compile Listing 7-9 (`javac StringDemo.java`) and run this application (`java StringDemo`). You should observe the following output:

```
3
true
true
false
true
```

By default, String objects denoted by literal strings ("abc") and string-valued constant expressions ("a" + "bc") are interned, which is why `System.out.println("abc" == "a" + "bc");` outputs `true`. However, String objects created via String constructors are not interned, which is why `System.out.println("abc" == new String("abc"));` outputs `false`. In contrast, `System.out.println("abc" == new String("abc").intern());` outputs `true`.

**Caution** Be careful with this string comparison technique (which only compares references) because you can easily introduce a bug when one of the strings being compared has not been interned. When in doubt, use the `equals()` or `equalsIgnoreCase()` method. For example, each of `"abc".equals(new String("abc"))` and `"abc".equalsIgnoreCase(new String("ABC"))` returns `true`.

Table 7-5 also reveals the `charAt()` method, which is useful for extracting a string's characters. Listing 7-10 offers a demonstration.

*Listing 7-10. Iterating Over a String*

```
public class StringDemo
{
    public static void main(String[] args)
    {
        String s = "abc";
        for (int i = 0; i < s.length(); i++)
            System.out.println(s.charAt(i));
    }
}
```

Compile Listing 7-10 and run this application. You will observe that `for (int i = 0; i < s.length(); i++) System.out.println(s.charAt(i));` returns each of `s`'s `a`, `b`, and `c` characters and outputs it on a separate line.

Finally, Table 7-5 presents `split()`, a method that I employed in Chapter 6's `StubFinder` application to split a string's comma-separated list of values into an array of `String` objects. This method uses a regular expression that identifies a sequence of characters around which the string is split. (I will discuss regular expressions in Chapter 13.)

**Note** `StringIndexOutOfBoundsException` and `ArrayIndexOutOfBoundsException` are sibling classes that share a common `java.lang.IndexOutOfBoundsException` superclass.

## StringBuffer and StringBuilder

`String` objects are immutable: you cannot modify a `String` object's string. The `String` methods that appear to modify the `String` object (such as `replace()`) actually return a new `String` object with modified string content instead. Because returning new `String` objects is often wasteful, Java provides the `StringBuffer` and `StringBuilder` classes as a workaround.

`StringBuffer` and `StringBuilder` are identical apart from the fact that `StringBuilder` offers better performance than `StringBuffer` but cannot be used in the context of multiple threads without explicit synchronization. (I discuss threads and synchronization later in this chapter.)

**Tip** Use `StringBuffer` in a multithreaded context (for safety) and `StringBuilder` in a single-threaded context (for performance).

`StringBuffer` and `StringBuilder` provide an internal character array for building a string efficiently. After creating a `StringBuffer`/`StringBuilder` object, you call various methods to append, delete, and insert the character representations of various values to, from, and into the array. You then call `toString()` to convert the array's content to a `String` object and return this object.

Table 7-6 describes some of `StringBuffer`'s constructors and methods for initializing `StringBuffer` objects and working with string buffers. `StringBuilder`'s constructors and methods are identical and won't be discussed.

**Table 7-6.** *StringBuffer Constructors and Methods*

Method	Description
<code>StringBuffer()</code>	Initializes this <code>StringBuffer</code> object to an empty array with an initial capacity of 16 characters.
<code>StringBuffer(int capacity)</code>	Initializes this <code>StringBuffer</code> object to an empty array with an initial capacity of <code>capacity</code> characters. This constructor throws <code>java.lang.NegativeArraySizeException</code> when <code>capacity</code> is negative.
<code>StringBuffer(String s)</code>	Initializes this <code>StringBuffer</code> object to an array containing <code>s</code> 's characters. This object's initial capacity is 16 plus the length of <code>s</code> . This constructor throws <code>NullPointerException</code> when <code>s</code> is <code>null</code> .
<code>StringBuffer append(boolean b)</code>	Appends "true" to this <code>StringBuffer</code> object's array when <code>b</code> is true and "false" to the array when <code>b</code> is false, and returns this <code>StringBuffer</code> object.
<code>StringBuffer append(char ch)</code>	Appends <code>ch</code> 's character to this <code>StringBuffer</code> object's array, and returns this <code>StringBuffer</code> object.
<code>StringBuffer append(char[] chars)</code>	Appends the characters in the <code>chars</code> array to this <code>StringBuffer</code> object's array, and returns this <code>StringBuffer</code> object. This method throws <code>NullPointerException</code> when <code>chars</code> is <code>null</code> .
<code>StringBuffer append(double d)</code>	Appends the string representation of <code>d</code> 's double precision floating-point value to this <code>StringBuffer</code> object's array, and returns this <code>StringBuffer</code> object.
<code>StringBuffer append(float f)</code>	Appends the string representation of <code>f</code> 's floating-point value to this <code>StringBuffer</code> object's array, and returns this <code>StringBuffer</code> object.
<code>StringBuffer append(int i)</code>	Appends the string representation of <code>i</code> 's integer value to this <code>StringBuffer</code> object's array, and returns this <code>StringBuffer</code> object.
<code>StringBuffer append(long l)</code>	Appends the string representation of <code>l</code> 's long integer value to this <code>StringBuffer</code> object's array, and returns this <code>StringBuffer</code> object.
<code>StringBuffer append(Object obj)</code>	Calls <code>obj</code> 's <code>toString()</code> method and appends the returned string's characters to this <code>StringBuffer</code> object's array. Appends "null" to the array when <code>null</code> is passed to <code>obj</code> . Returns this <code>StringBuffer</code> object.
<code>StringBuffer append(String s)</code>	Appends <code>s</code> 's string to this <code>StringBuffer</code> object's array. Appends "null" to the array when <code>null</code> is passed to <code>s</code> . Returns this <code>StringBuffer</code> object.
<code>int capacity()</code>	Returns the current capacity of this <code>StringBuffer</code> object's array.

(continued)

Table 7-6. (continued)

Method	Description
<code>char charAt(int index)</code>	Returns the character located at <code>index</code> in this <code>StringBuffer</code> object's array. This method throws <code>StringIndexOutOfBoundsException</code> when <code>index</code> is negative or greater than or equal to this <code>StringBuffer</code> object's length.
<code>void ensureCapacity(int min)</code>	Ensures that this <code>StringBuffer</code> object's capacity is at least that specified by <code>min</code> . If the current capacity is less than <code>min</code> , a new internal array is created with greater capacity. The new capacity is set to the larger of <code>min</code> and the current capacity multiplied by 2, with 2 added to the result. No action is taken when <code>min</code> is negative or zero.
<code>int length()</code>	Returns the number of characters stored in this <code>StringBuffer</code> object's array.
<code>StringBuffer reverse()</code>	Returns this <code>StringBuffer</code> object with its array contents reversed.
<code>void setCharAt(int index, char ch)</code>	Replaces the character at <code>index</code> with <code>ch</code> . This method throws <code>StringIndexOutOfBoundsException</code> when <code>index</code> is negative or greater than or equal to the length of this <code>StringBuffer</code> object's array.
<code>void setLength(int length)</code>	Sets the length of this <code>StringBuffer</code> object's array to <code>length</code> . If the <code>length</code> argument is less than the current length, the array's contents are truncated. If the <code>length</code> argument is greater than or equal to the current length, sufficient null characters ( <code>'\u0000'</code> ) are appended to the array. This method throws <code>StringIndexOutOfBoundsException</code> when <code>length</code> is negative.
<code>String substring(int start)</code>	Returns a new <code>String</code> object that contains all characters in this <code>StringBuffer</code> object's array starting with the character located at <code>start</code> . This method throws <code>StringIndexOutOfBoundsException</code> when <code>start</code> is less than 0 or greater than or equal to the length of this <code>StringBuffer</code> object's array.
<code>String toString()</code>	Returns a new <code>String</code> object whose string equals the contents of this <code>StringBuffer</code> object's array.

A `StringBuffer` or `StringBuilder` object's internal array is associated with the concepts of capacity and length. *Capacity* refers to the maximum number of characters that can be stored in the array before the array grows to accommodate additional characters. *Length* refers to the number of characters that are already stored in the array.

Listing 7-11 demonstrates `StringBuffer()`, various `append()` methods, and `toString()`.

**Listing 7-11. Demonstrating `StringBuffer`**

```
public class StringBufferDemo
{
    public static void main(String[] args)
    {
        StringBuffer sb = new StringBuffer("Hello,");
        sb.append(' ');
        sb.append("world. ");
        sb.append(args.length);
        sb.append(" argument(s) have been passed to this method.");
    }
}
```

```

    String s = sb.toString();
    System.out.println(s);
}
}

```

After creating a `StringBuffer` object initialized to the contents of the interned "Hello," `String` object, `main()` appends a character, another `String` object, an integer (identifying the number of command-line arguments passed to this application), and yet another `String` object to this buffer. It then converts the `StringBuffer`'s contents to a `String` object and prints this object's content on the standard output device.

Compile Listing 7-11 (`javac StringBufferDemo.java`) and run this application (`java StringBufferDemo`). You should observe the following output:

```
Hello, world. 0 argument(s) have been passed to this method.
```

Re-run this application with one or more command-line arguments and the number will change to reflect how many command-line arguments were passed.

Consider a scenario where you've written code to format an integer value into a string. As part of the formatter, you need to prepend a specific number of leading spaces to the integer. You decide to use the following initialization code and loop to build a `spacesPrefix` string with three leading spaces:

```

int numLeadingSpaces = 3; // default value
String spacesPrefix = "";
for (int j = 0; j < numLeadingSpaces; j++)
    spacesPrefix += "0";

```

This loop is inefficient because each of the iterations creates a `StringBuilder` object and a `String` object. The compiler transforms this code fragment into the following fragment:

```

int numLeadingSpaces = 3; // default value
String spacesPrefix = "";
for (int j = 0; j < numLeadingSpaces; j++)
    spacesPrefix = new StringBuilder().append(spacesPrefix).append("0").toString();

```

A more efficient way to code the previous loop involves creating a `StringBuilder/StringBuffer` object prior to entering the loop, calling the appropriate `append()` method in the loop, and calling `toString()` after the loop. The following code fragment demonstrates this more efficient scenario:

```

int numLeadingSpaces = 3; // default value
StringBuilder sb = new StringBuilder();
for (int j = 0; j < numLeadingSpaces; j++)
    sb.append('0');
String spacesPrefix = sb.toString();

```

**Caution** Avoid using the string concatenation operator in a lengthy loop because it results in the creation of many unnecessary `StringBuilder` and `String` objects.

## Exploring System

The `java.lang.System` utility class declares class methods that provide access to the current time (in milliseconds), system property values, environment variable values, and other kinds of system information. Furthermore, it declares class methods that support the system tasks of copying one array to another array, requesting garbage collection, and so on.

Table 7-7 describes some of `System`'s methods.

**Table 7-7.** *System Methods*

Method	Description
<code>void arraycopy(Object src, int srcPos, Object dest, int destPos, int length)</code>	Copies the number of elements specified by <code>length</code> from the <code>src</code> array starting at zero-based offset <code>srcPos</code> into the <code>dest</code> array starting at zero-based offset <code>destPos</code> . This method throws <code>NullPointerException</code> when <code>src</code> or <code>dest</code> is null, <code>IndexOutOfBoundsException</code> when copying causes access to data outside array bounds, and <code>java.lang.ArrayStoreException</code> when an element in the <code>src</code> array cannot be stored into the <code>dest</code> array because of a type mismatch.
<code>long currentTimeMillis()</code>	Returns the current system time in milliseconds since January 1, 1970 00:00:00 UTC (Coordinated Universal Time—see <a href="http://en.wikipedia.org/wiki/Coordinated_Universal_Time">http://en.wikipedia.org/wiki/Coordinated_Universal_Time</a> ).
<code>void gc()</code>	Informs the virtual machine that now would be a good time to run the garbage collector. This is only a hint; there is no guarantee that the garbage collector will run.
<code>String getEnv(String name)</code>	Returns the value of the environment variable identified by name.
<code>String getProperty(String name)</code>	Returns the value of the <i>system property</i> (platform-specific attribute, such as a version number) identified by name, or returns null when such a property doesn't exist. Examples of system properties that are useful in an Android context include <code>file.separator</code> , <code>java.class.path</code> , <code>java.home</code> , <code>java.io.tmpdir</code> , <code>java.library.path</code> , <code>line.separator</code> , <code>os.arch</code> , <code>os.name</code> , <code>path.separator</code> , and <code>user.dir</code> .
<code>void runFinalization()</code>	Informs the virtual machine that now would be a good time to perform any outstanding object finalizations. This is only a hint; there is no guarantee that outstanding object finalizations will be performed.

**Note** `System` declares `SecurityManager getSecurityManager()` and `void setSecurityManager(SecurityManager sm)` methods that are not supported by Android. On an Android device, the former method always returns null, and the latter method always throws an instance of the `java.lang.SecurityException` class. Regarding the latter method, its documentation states that “security managers do not provide a secure environment for executing untrusted code and are unsupported on Android. Untrusted code cannot be safely isolated within a single virtual machine on Android.”



Listing 7-12 demonstrates the `arraycopy()`, `currentTimeMillis()`, and `getProperty()` methods.

*Listing 7-12. Experimenting with System Methods*

```
public class SystemDemo
{
    public static void main(String[] args)
    {
        int[] grades = { 86, 92, 78, 65, 52, 43, 72, 98, 81 };
        int[] gradesBackup = new int[grades.length];
        System.arraycopy(grades, 0, gradesBackup, 0, grades.length);
        for (int i = 0; i < gradesBackup.length; i++)
            System.out.println(gradesBackup[i]);
        System.out.println("Current time: " + System.currentTimeMillis());
        String[] propNameNames =
        {
            "file.separator",
            "java.class.path",
            "java.home",
            "java.io.tmpdir",
            "java.library.path",
            "line.separator",
            "os.arch",
            "os.name",
            "path.separator",
            "user.dir"
        };
        for (int i = 0; i < propNameNames.length; i++)
            System.out.println(propNameNames[i] + ": " +
                System.getProperty(propNameNames[i]));
    }
}
```

Listing 7-12's `main()` method begins by demonstrating `arraycopy()`. It uses this method to copy the contents of a `grades` array to a `gradesBackup` array.

**Tip** The `arraycopy()` method is the fastest portable way to copy one array to another. Also, when you write a class whose methods return a reference to an internal array, you should use `arraycopy()` to create a copy of the array and then return the copy's reference. That way, you prevent clients from directly manipulating (and possibly screwing up) the internal array.

`main()` next calls `currentTimeMillis()` to return the current time as a milliseconds value. Because this value is not human-readable, you might want to use the `java.util.Date` class (discussed in Chapter 16). The `Date()` constructor calls `currentTimeMillis()` and its `toString()` method converts this value to a readable date and time.

`main()` concludes by demonstrating `getProperty()` in a for loop. This loop iterates over all of Table 7-7's property names, outputting each name and value.

Compile Listing 7-12 (`javac SystemDemo.java`) and run this application (`java SystemDemo`). When I run this application on my platform, it generates the following output:

```

86
92
78
65
52
43
72
98
81
Current time: 1353115138889
file.separator: \
java.class.path: .;C:\Program Files (x86)\QuickTime\QTSystem\QTJava.zip
java.home: C:\Program Files\Java\jre7
java.io.tmpdir: C:\Users\Owner\AppData\Local\Temp\
java.library.path: C:\Windows\system32;C:\Windows\Sun\Java\bin;C:\Windows\system32;C:\Windows;c:\
Program Files (x86)\AMD APP\bin\x86_64;c:\Program Files (x86)\AMD APP\bin\x86;C:\Program Files\
Common Files\Microsoft Shared\Windows Live;C:\Program Files (x86)\Common Files\Microsoft Shared\
Windows Live;C:\Windows\system32;C:\Windows;C:\Windows\System32\Wbem;C:\Windows\System32\
WindowsPowerShell\v1.0\;C:\Program Files (x86)\ATI Technologies\ATI.ACE\Core-Static;C:\Program Files
(x86)\Windows Live\Shared;C:\Program Files\java\jdk1.7.0_06\bin;C:\Program Files (x86)\Borland\
BCC55\bin;C:\android;C:\android\tools;C:\android\platform-tools;C:\Program Files (x86)\apache-
ant-1.8.2\bin;C:\Program Files (x86)\QuickTime\QTSystem\;.
line.separator:

os.arch: amd64
os.name: Windows 7
path.separator: ;
user.dir: C:\prj\dev\ljfad2\ch08\code\SystemDemo

```

**Note** `line.separator` stores the actual line separator character/characters, not its/their representation (such as `\r\n`), which is why a blank line appears after `line.separator`.

## Exploring Threads

Applications execute via *threads*, which are independent paths of execution through an application's code. When multiple threads are executing, each thread's path can differ from other thread paths. For example, a thread might execute one of a switch statement's cases, and another thread might execute another of this statement's cases.

**Note** Applications use threads to improve performance. Some applications can get by with only the *default main thread* (the thread that executes the `main()` method) to carry out their tasks, but other applications need additional threads to perform time-intensive tasks in the background, so that they remain responsive to their users.

The virtual machine gives each thread its own method-call stack to prevent threads from interfering with each other. Separate stacks let threads keep track of their next instructions to execute, which can differ from thread to thread. The stack also provides a thread with its own copy of method parameters, local variables, and return value.

Java supports threads via its `Threads` API. This API largely consists of one interface (`Runnable`) and four classes (`Thread`, `ThreadGroup`, `ThreadLocal`, and `InheritableThreadLocal`) in the `java.lang` package. After exploring `Runnable` and `Thread` (and mentioning `ThreadGroup` during this exploration), I explore synchronization, `ThreadLocal`, and `InheritableThreadLocal`.

**Note** Java 5 introduced the `java.util.concurrent` package as a high-level alternative to the low-level `Threads` API. (I will discuss this package in Chapter 10.) Although `java.util.concurrent` is the preferred API for working with threads, you should also be somewhat familiar with `Threads` because it's helpful in simple threading scenarios. Also, you might have to analyze someone else's source code that depends on `Threads`.

## Runnable and Thread

Java's `Runnable` interface identifies those objects that supply code for threads to execute via this interface's solitary `run()` method—a thread receives no arguments and returns no value. In the following code fragment, an anonymous class implements `Runnable`:

```
Runnable r = new Runnable()
{
    @Override
    public void run()
    {
        // perform some work
    }
};
```

Java's `Thread` class provides a consistent interface to the underlying operating system's threading architecture. (The operating system is typically responsible for creating and managing threads.) A single operating system thread is associated with a `Thread` object.

Thread declares several constructors for initializing Thread objects. Some of these constructors take Runnable arguments. For example, `Thread(Runnable runnable)` initializes a new Thread object to the specified runnable whose code is to be executed, which the following code fragment demonstrates:

```
Thread t = new Thread(r);
```

Other constructors don't take Runnable arguments. For example, `Thread()` doesn't initialize Thread to a Runnable argument. You must extend Thread and override its `run()` method to supply the code to run, which the following code fragment accomplishes:

```
class MyThread extends Thread
{
    @Override
    public void run()
    {
    }
}
```

In the absence of an explicit name argument, each constructor assigns a unique default name (starting with Thread-) to the Thread object. Names make it possible to differentiate threads. In contrast to the previous two constructors, which choose default names, `Thread(String threadName)` lets you specify your own thread name.

Thread also declares methods for starting and managing threads. Table 7-8 describes many of the more useful methods.

**Table 7-8. Thread Methods**

Method	Description
<code>static Thread currentThread()</code>	Returns the Thread object associated with the thread that calls this method.
<code>String getName()</code>	Returns the name associated with this Thread object.
<code>Thread.State getState()</code>	Returns the state of the thread associated with this Thread object. The state is identified by the Thread.State enum as one of BLOCKED (waiting to acquire a lock, discussed later), NEW (created but not started), RUNNABLE (executing), TERMINATED (the thread has died), TIMED_WAITING (waiting for a specified amount of time to elapse), or WAITING (waiting indefinitely).
<code>void interrupt()</code>	Sets the interrupt status flag in this Thread object. If the associated thread is blocked or is waiting, clear this flag and wake up the thread by throwing an instance of the <code>java.lang.InterruptedException</code> class.
<code>static boolean interrupted()</code>	Returns true when the thread associated with this Thread object has a pending interrupt request. Clears the interrupt status flag.
<code>boolean isAlive()</code>	Returns true to indicate that this Thread object's associated thread is alive and not dead. A thread's life span ranges from just before it is actually started within the <code>start()</code> method to just after it leaves the <code>run()</code> method, at which point it dies.

(continued)

**Table 7-8.** (continued)

Method	Description
<code>boolean isDaemon()</code>	Returns true when the thread associated with this <code>Thread</code> object is a <i>daemon thread</i> , a thread that acts as a helper to a <i>user thread</i> (nondaemon thread) and dies automatically when the application's last nond daemon thread dies so the application can exit.
<code>boolean isInterrupted()</code>	Returns true when the thread associated with this <code>Thread</code> object has a pending interrupt request.
<code>void join()</code>	The thread that calls this method on this <code>Thread</code> object waits for the thread associated with this object to die. This method throws <code>InterruptedException</code> when this <code>Thread</code> object's <code>interrupt()</code> method is called.
<code>void join(long millis)</code>	The thread that calls this method on this <code>Thread</code> object waits for the thread associated with this object to die, or until <code>millis</code> milliseconds have elapsed, whichever happens first. This method throws <code>InterruptedException</code> when this <code>Thread</code> object's <code>interrupt()</code> method is called.
<code>void setDaemon(boolean isDaemon)</code>	Marks this <code>Thread</code> object's associated thread as a daemon thread when <code>isDaemon</code> is true. This method throws <code>java.lang.IllegalThreadStateException</code> when the thread has not yet been created and started.
<code>void setName(String threadName)</code>	Assigns <code>threadName</code> 's value to this <code>Thread</code> object as the name of its associated thread.
<code>static void sleep(long time)</code>	Pauses the thread associated with this <code>Thread</code> object for time milliseconds. This method throws <code>InterruptedException</code> when this <code>Thread</code> object's <code>interrupt()</code> method is called while the thread is sleeping.
<code>void start()</code>	Creates and starts this <code>Thread</code> object's associated thread. This method throws <code>IllegalThreadStateException</code> when the thread was previously started and is running or has died.

Listing 7-13 introduces you to the `Threads` API via a `main()` method that demonstrates `Runnable`, `Thread(Runnable runnable)`, `currentThread()`, `getName()`, and `start()`.

**Listing 7-13.** A Pair of Counting Threads

```
public class CountingThreads
{
    public static void main(String[] args)
    {
        Runnable r = new Runnable()
        {
            @Override
            public void run()
            {
                String name = Thread.currentThread().getName();
                int count = 0;
            }
        };
    }
}
```

```

        while (true)
            System.out.println(name + ": " + count++);
    }
};
Thread thdA = new Thread(r);
Thread thdB = new Thread(r);
thdA.start();
thdB.start();
}
}

```

According to Listing 7-13, the default main thread that executes `main()` first instantiates an anonymous class that implements `Runnable`. It then creates two `Thread` objects, initializing each object to the `Runnable`, and calls `Thread`'s `start()` method to create and start both threads. After completing these tasks, the main thread exits `main()` and dies.

Each of the two started threads executes the `Runnable`'s `run()` method. It calls `Thread`'s `currentThread()` method to obtain its associated `Thread` instance, uses this instance to call `Thread`'s `getName()` method to return its name, initializes `count` to 0, and enters an infinite loop where it outputs `name` and `count`, and increments `count` on each iteration.

**Tip** To stop an application that doesn't end, press the `Ctrl` and `C` keys simultaneously on a Windows platform or do the equivalent on a non-Windows platform.

I observed both threads alternating in their execution when I ran this application on the 64-bit Windows 7 platform. Partial output from one run appears here:

```

Thread-0: 0
Thread-0: 1
Thread-1: 0
Thread-0: 2
Thread-1: 1
Thread-0: 3
Thread-1: 2
Thread-0: 4
Thread-1: 3
Thread-0: 5
Thread-1: 4
Thread-0: 6
Thread-1: 5
Thread-0: 7
Thread-1: 6
Thread-1: 7
Thread-1: 8
Thread-1: 9
Thread-1: 10
Thread-1: 11
Thread-1: 12

```

**Note** I executed `java CountThreads >output.txt` to capture the output to `output.txt` and then presented part of this file's content above. Capturing output to a file may significantly affect the output that would otherwise be observed if output wasn't captured. Because I present captured thread output throughout this section, bear this in mind when executing the application on your platform. Also, note that your platform's threading architecture may impact the observable results. I've tested each thread example on the 64-bit Windows 7 platform.

Also, although the output shows that the first thread (Thread-0) starts executing, never assume that the thread associated with the Thread object whose `start()` method is called first will execute first.

When a computer has enough processors and/or processor cores, the computer's operating system assigns a separate thread to each processor or core so the threads execute simultaneously. When a computer doesn't have enough processors and/or cores, various threads must wait their turns to use the shared processors/cores.

The operating system uses a *scheduler* ([http://en.wikipedia.org/wiki/Scheduling\\_\(computing\)](http://en.wikipedia.org/wiki/Scheduling_(computing))) to determine when a waiting thread executes. The following list identifies three different schedulers:

- Linux 2.6 through 2.6.22 uses the *O(1) Scheduler* ([http://en.wikipedia.org/wiki/O\(1\)\\_scheduler](http://en.wikipedia.org/wiki/O(1)_scheduler)).
- Linux 2.6.23 uses the *Completely Fair Scheduler* ([http://en.wikipedia.org/wiki/Completely\\_Fair\\_Scheduler](http://en.wikipedia.org/wiki/Completely_Fair_Scheduler)).
- Windows NT-based operating systems (NT, XP, Vista, and 7) use a *multilevel feedback queue scheduler* ([http://en.wikipedia.org/wiki/Multilevel\\_feedback\\_queue](http://en.wikipedia.org/wiki/Multilevel_feedback_queue)). This scheduler has been adjusted in Windows Vista and Windows 7 to optimize performance.

A multilevel feedback queue and many other thread schedulers take *priority* (thread relative importance) into account. They often combine *preemptive scheduling* (higher priority threads *preempt*—interrupt and run instead of—lower priority threads) with *round robin scheduling* (equal priority threads are given equal slices of time, which are known as *time slices*, and take turns executing).

**Note** Two terms that are commonly encountered when exploring threads are parallelism and concurrency. According to Oracle's "Multithreading Guide" (<http://docs.oracle.com/cd/E19455-01/806-5257/6je9h032b/index.html>), *parallelism* is "a condition that arises when at least two threads are **executing** simultaneously." In contrast, *concurrency* is "a condition that exists when at least two threads are **making progress**. [It is a] more generalized form of parallelism that can include time-slicing as a form of virtual parallelism."

Thread supports priority via its void `setPriority(int priority)` method (set the priority of this Thread object's thread to `priority`, which ranges from `Thread.MIN_PRIORITY` to `Thread.MAX_PRIORITY`—`Thread.NORMAL_PRIORITY` identifies the default priority) and `int getPriority()` method (return the current priority).

**Caution** Using the `setPriority()` method can impact an application's portability across platforms because different schedulers can handle a priority change in different ways. For example, one platform's scheduler might delay lower priority threads from executing until higher priority threads finish. This delaying can lead to *indefinite postponement* or *starvation* because lower priority threads “starve” while waiting indefinitely for their turn to execute, and this can seriously hurt the application's performance. Another platform's scheduler might not indefinitely delay lower priority threads, improving application performance.

Listing 7-14 refactors Listing 7-13's `main()` method to give each thread a nondefault name and to put each thread to sleep after outputting name and count.

*Listing 7-14. A Pair of Counting Threads Revisited*

```
public class CountingThreads
{
    public static void main(String[] args)
    {
        Runnable r = new Runnable()
        {
            @Override
            public void run()
            {
                String name = Thread.currentThread().getName();
                int count = 0;
                while (true)
                {
                    System.out.println(name + ": " + count++);
                    try
                    {
                        Thread.sleep(100);
                    }
                    catch (InterruptedException ie)
                    {
                    }
                }
            }
        };
        Thread thdA = new Thread(r);
        thdA.setName("A");
        Thread thdB = new Thread(r);
        thdB.setName("B");
    }
}
```



```

        thdA.start();
        thdB.start();
    }
}

```

Listing 7-14 reveals that threads A and B execute `Thread.sleep(100)`; to sleep for 100 milliseconds. This sleep results in each thread executing more frequently, as the following partial output reveals:

```

A: 0
B: 0
A: 1
B: 1
B: 2
A: 2
B: 3
A: 3
B: 4
A: 4
B: 5
A: 5
B: 6
A: 6
B: 7
A: 7

```

A thread will occasionally start another thread to perform a lengthy calculation, download a large file, or perform some other time-consuming activity. After finishing its other tasks, the thread that started the *worker thread* is ready to process the results of the worker thread and waits for the worker thread to finish and die.

It's possible to wait for the worker thread to die by using a while loop that repeatedly calls `Thread's isAlive()` method on the worker thread's `Thread` object and sleeps for a certain length of time when this method returns true. However, Listing 7-15 demonstrates a less verbose alternative: the `join()` method.

**Listing 7-15. Joining the Default Main Thread with a Background Thread**

```

public class JoinDemo
{
    public static void main(String[] args)
    {
        Runnable r = new Runnable()
        {
            @Override
            public void run()
            {
                System.out.println("Worker thread is simulating " +
                    "work by sleeping for 5 seconds.");

                try
                {
                    Thread.sleep(5000);
                }
            }
        }
    }
}

```

```

        catch (InterruptedException ie)
        {
        }
        System.out.println("Worker thread is dying");
    }
};
Thread thd = new Thread(r);
thd.start();
System.out.println("Default main thread is doing work.");
try
{
    Thread.sleep(2000);
}
catch (InterruptedException ie)
{
}
System.out.println("Default main thread has finished its work.");
System.out.println("Default main thread is waiting for worker thread " +
    "to die.");

try
{
    thd.join();
}
catch (InterruptedException ie)
{
}
System.out.println("Main thread is dying");
}
}

```

Listing 7-15 demonstrates the default main thread starting a worker thread, performing some work, and then waiting for the worker thread to die by calling `join()` via the worker thread's `thd` object. When you run this application, you will discover output similar to the following (message order might differ somewhat):

```

Default main thread is doing work.
Worker thread is simulating work by sleeping for 5 seconds.
Default main thread has finished its work.
Default main thread is waiting for worker thread to die.
Worker thread is dying
Main thread is dying

```

Every `Thread` object belongs to some `ThreadGroup` object; `Thread` declares a `ThreadGroup` `getThreadGroup()` method that returns this object. You should ignore thread groups because they are not that useful. If you need to logically group `Thread` objects, you should use an array or collection instead.

**Caution** Various `ThreadGroup` methods are flawed. For example, `int enumerate(Thread[] threads)` will not include all active threads in its enumeration when its `threads` array argument is too small to store their `Thread` objects. Although you might think that you could use the return value from the `int activeCount()` method to properly size this array, there is no guarantee that the array will be large enough because `activeCount()`'s return value fluctuates with the creation and death of threads.

However, you should still know about `ThreadGroup` because of its contribution in handling exceptions that are thrown while a thread is executing. Listing 7-16 sets the stage for learning about exception handling by presenting a `run()` method that attempts to divide an integer by 0, which results in a thrown `ArithmeticException` instance.

*Listing 7-16. Throwing an Exception from the `run()` Method*

```
public class ExceptionThread
{
    public static void main(String[] args)
    {
        Runnable r = new Runnable()
        {
            @Override
            public void run()
            {
                int x = 1 / 0; // Line 10
            }
        };
        Thread thd = new Thread(r);
        thd.start();
    }
}
```

Run this application and you will see an exception trace that identifies the thrown `ArithmeticException`.

```
Exception in thread "Thread-0" java.lang.ArithmeticException: / by zero
    at ExceptionThread$1.run(ExceptionThread.java:10)
    at java.lang.Thread.run(Unknown Source)
```

When an exception is thrown out of the `run()` method, the thread terminates and the following activities take place:

- The virtual machine looks for an instance of `Thread.UncaughtExceptionHandler` installed via `Thread's void setUncaughtExceptionHandler(Thread.UncaughtExceptionHandler eh)` method. When this handler is found, it passes execution to the instance's `void uncaughtException(Thread t, Throwable e)` method, where `t` identifies the `Thread` object of the thread that threw the exception, and `e` identifies the thrown exception or error—perhaps a `java.lang.OutOfMemoryError` instance was thrown. If this method throws an exception/error, the exception/error is ignored by the virtual machine.

- Assuming that `setUncaughtExceptionHandler()` was not called to install a handler, the virtual machine passes control to the associated `ThreadGroup` object's `uncaughtException(Thread t, Throwable e)` method. Assuming that `ThreadGroup` was not extended and that its `uncaughtException()` method was not overridden to handle the exception, `uncaughtException()` passes control to the parent `ThreadGroup` object's `uncaughtException()` method when a parent `ThreadGroup` is present. Otherwise, it checks to see if a default uncaught exception handler has been installed (via `Thread`'s static void `setDefaultUncaughtExceptionHandler(Thread.UncaughtExceptionHandler handler)` method). If a default uncaught exception handler has been installed, its `uncaughtException()` method is called with the same two arguments. Otherwise, `uncaughtException()` checks its `Throwable` argument to determine if it is an instance of `java.lang.ThreadDeath`. If so, nothing special is done. Otherwise, as Listing 7-16's exception message shows, a message containing the thread's name, as returned from the thread's `getName()` method, and a stack backtrace, using the `Throwable` argument's `printStackTrace()` method, is printed to the standard error stream.

Listing 7-17 demonstrates `Thread`'s `setUncaughtExceptionHandler()` and `setDefaultUncaughtExceptionHandler()` methods.

*Listing 7-17. Demonstrating Uncaught Exception Handlers*

```
public class ExceptionThread
{
    public static void main(String[] args)
    {
        Runnable r = new Runnable()
        {
            @Override
            public void run()
            {
                int x = 1 / 0;
            }
        };
        Thread thd = new Thread(r);
        Thread.UncaughtExceptionHandler uceh;
        uceh = new Thread.UncaughtExceptionHandler()
        {
            @Override
            public void uncaughtException(Thread t, Throwable e)
            {
                System.out.println("Caught throwable " + e + " for thread "
                    + t);
            }
        };
        thd.setUncaughtExceptionHandler(uceh);
        uceh = new Thread.UncaughtExceptionHandler()
```

```

    {
        @Override
        public void uncaughtException(Thread t, Throwable e)
        {
            System.out.println("Default uncaught exception handler");
            System.out.println("Caught throwable " + e + " for thread "
                + t);
        }
    };
    thd.setDefaultUncaughtExceptionHandler(uceh);
    thd.start();
}
}

```

When you run this application, you will observe the following output:

```
Caught throwable java.lang.ArithmeticException: / by zero for thread Thread[Thread-0,5,main]
```

You will not also see the default uncaught exception handler's output because the default handler is not called. To see that output, you must comment out `thd.setUncaughtExceptionHandler(uceh);`. If you also comment out `thd.setDefaultUncaughtExceptionHandler(uceh);`, you will see Listing 7-16's output.

**Caution** Thread declares several deprecated methods, including `stop()` (stop an executing thread). These methods have been deprecated because they are unsafe. Do *not* use these deprecated methods. (I will show you how to safely stop a thread later in this chapter.) Also, you should avoid the static `void yield()` method, which is intended to switch execution from the current thread to another thread, because it can affect portability and hurt application performance. Although `yield()` might switch to another thread on some platforms (which can improve performance), `yield()` might only return to the current thread on other platforms (which hurts performance because the `yield()` call has only wasted time).

## Synchronization

Throughout its execution, each thread is isolated from other threads because it has been given its own method-call stack. However, threads can still interfere with each other when they access and manipulate shared data. This interference can corrupt the shared data, and this corruption can cause an application to fail.

For example, consider a checking account in which a husband and wife have joint access. Suppose that the husband and wife decide to empty this account at the same time without knowing that the other is doing the same thing. Listing 7-18 demonstrates this scenario.

*Listing 7-18. A Problematic Checking Account*

```
public class CheckingAccount
{
    private int balance;

    public CheckingAccount(int initialBalance)
    {
        balance = initialBalance;
    }

    public boolean withdraw(int amount)
    {
        if (amount <= balance)
        {
            try
            {
                Thread.sleep((int) (Math.random() * 200));
            }
            catch (InterruptedException ie)
            {
            }
            balance -= amount;
            return true;
        }
        return false;
    }

    public static void main(String[] args)
    {
        final CheckingAccount ca = new CheckingAccount(100);
        Runnable r = new Runnable()
        {
            public void run()
            {
                String name = Thread.currentThread().getName();
                for (int i = 0; i < 10; i++)
                    System.out.println (name + " withdraws $10: " +
                                         ca.withdraw(10));
            }
        };
        Thread thdHusband = new Thread(r);
        thdHusband.setName("Husband");
        Thread thdWife = new Thread(r);
        thdWife.setName("Wife");
        thdHusband.start();
        thdWife.start();
    }
}
```

This application lets more money be withdrawn than is available in the account. For example, the following output reveals \$110 being withdrawn when only \$100 is available:

```

Wife withdraws $10: true
Husband withdraws $10: true
Husband withdraws $10: true
Wife withdraws $10: true
Wife withdraws $10: true
Husband withdraws $10: true
Wife withdraws $10: true
Wife withdraws $10: true
Wife withdraws $10: true
Husband withdraws $10: true
Husband withdraws $10: false
Husband withdraws $10: false
Husband withdraws $10: false
Husband withdraws $10: false
Husband withdraws $10: false
Husband withdraws $10: false
Wife withdraws $10: true
Wife withdraws $10: false
Wife withdraws $10: false
Wife withdraws $10: false

```

The reason why more money is withdrawn than is available for withdrawal is that a race condition exists between the husband and wife threads.

**Note** A *race condition* is a scenario in which multiple threads are accessing shared data and the final result of these accesses is dependent on the timing of how the threads are scheduled. Race conditions can lead to bugs that are hard to find and results that are unpredictable.

In this example, there is a race condition between checking the amount for withdrawal to ensure that it is less than what appears in the balance and deducting the amount from the balance. The race condition exists because these actions are not *atomic* (indivisible) operations. (Although atoms are divisible, atomic is commonly used to refer to something being indivisible.)

**Note** The `Thread.sleep()` method call that sleeps for a variable amount of time (up to a maximum of 199 milliseconds) is present so that you can observe more money being withdrawn than is available for withdrawal. Without this method call, you might have to execute the application hundreds of times (or more) to witness this problem, because the scheduler might rarely pause a thread between the amount `<= balance` expression and the `balance -= amount; expression` statement; the code executes rapidly.

Consider the following scenario:

- The Husband thread executes `withdraw()`'s `amount <= balance` expression, which returns `true`. The scheduler then suspends the Husband thread and executes the Wife thread.
- The Wife thread executes `withdraw()`'s `amount <= balance` expression, which returns `true`.
- The Wife thread performs the withdrawal. The scheduler suspends the Wife thread and resumes the Husband thread.
- The Husband thread performs the withdrawal.

This problem can be corrected by *synchronizing* access to `withdraw()` so that only one thread at a time can execute inside this method. You can synchronize access to this method by adding reserved word `synchronized` to the method header prior to the method's return type, for example, `synchronized boolean withdraw(int amount)`.

When you run the modified `CheckingAccount` application, you should observe output similar to the following:

```
Husband withdraws $10: true
Wife withdraws $10: true
Husband withdraws $10: true
Wife withdraws $10: true
Husband withdraws $10: true
Wife withdraws $10: true
Husband withdraws $10: true
Wife withdraws $10: true
Husband withdraws $10: true
Husband withdraws $10: false
Husband withdraws $10: false
Husband withdraws $10: false
Husband withdraws $10: false
Husband withdraws $10: false
Wife withdraws $10: true
Wife withdraws $10: false
Wife withdraws $10: false
Wife withdraws $10: false
Wife withdraws $10: false
Wife withdraws $10: false
```

The need for synchronization is often subtle. For example, Listing 7-19's ID utility class declares a `getNextID()` method that returns a unique long-based ID, perhaps to be used when generating unique filenames. Although you might not think so, this method can cause data corruption and return duplicate values on a 32-bit machine.



Listing 7-19. A Utility Class for Returning Unique IDs

```
class ID
{
    private static long nextID = 0;
    static long getNextID()
    {
        return nextID++;
    }
}
```

Data corruption occurs because 32-bit virtual machine implementations require two steps to update a 64-bit long integer and adding 1 to `nextID` is not atomic: the scheduler could interrupt a thread that has only updated half of `nextID`, which corrupts the contents of this variable.

**Note** Variables of type `long` and `double` are subject to corruption when being written to in an unsynchronized context on 32-bit virtual machines. This problem doesn't occur with variables of type `boolean`, `byte`, `char`, `float`, `int`, or `short`; each type occupies 32 bits or less.

Duplicate values are returned because postincrement (`++`) reads and writes the `nextID` field in two steps, thread A reads `nextID` but does not increment its value before being interrupted by the scheduler, and thread B executes and reads the same value.

Both problems can be corrected by synchronizing access to `nextID` so that only one thread can execute this method's code. All that is required is to add `synchronized` to the method header prior to the method's return type; for example, `static synchronized int getNextID()`.

As I will demonstrate later, you can also synchronize access to a block of statements by specifying the following syntax:

```
synchronized(object)
{
    /* statements */
}
```

According to this syntax, *object* is an arbitrary object reference.

## Mutual Exclusion, Monitors, and Locks

Whether you are synchronizing access to a method or a block of statements, no thread can enter the synchronized region until a thread that's already executing inside that region leaves it. This property of synchronization is known as *mutual exclusion*.

Mutual exclusion is implemented in terms of monitors and locks. A *monitor* is a concurrency construct for controlling access to a *critical section*, a region of code that must execute atomically. It is identified at the source code level as a synchronized method or a synchronized block.

A *lock* is a token that a thread must acquire before a monitor allows that thread to execute inside a monitor's critical section. The token is released automatically when the thread exits the monitor, to give another thread an opportunity to acquire the token and enter the monitor.

**Note** A thread that has acquired a lock doesn't release this lock when it calls one of Thread's `sleep()` methods.

A thread entering a synchronized instance method acquires the lock associated with the object on which the method is called. A thread entering a synchronized class method acquires the lock associated with the class's `java.lang.Class` object. Finally, a thread entering a synchronized block acquires the lock associated with the block's controlling object.

**Tip** Thread declares a static `boolean holdsLock(Object o)` method that returns `true` when the calling thread holds the monitor lock on object `o`. You will find this method handy in assertion statements, such as `assert Thread.holdsLock(o);`.

## Visibility

For performance reasons, each thread can have its own copy of a shared variable stored in a local *cache* (localized high-speed memory). Without synchronization, one thread's write to its copy will not be visible to other thread's copies. Ideally, when a thread updates a shared variable, this update should be made to the copy stored in main memory so that other threads can see these updates.

Synchronization also has the property of *visibility* in which shared variable values in main memory are copied to cache memory upon entry to a critical section and copied from cache memory to main memory upon exit from a critical section. Visibility addresses the vagaries of memory caching and compiler optimizations that might otherwise prevent one thread from observing another thread's update of a shared variable.

Visibility makes it possible to communicate between threads. For example, you might design your own mechanism for stopping a thread (because you cannot use Thread's `unsafe stop()` methods for this task). Listing 7-20 shows how you might accomplish this task.

*Listing 7-20. Attempting to Stop a Thread*

```
public class ThreadStopping
{
    public static void main(String[] args)
    {
        class StoppableThread extends Thread
        {
            private boolean stopped = false;
```

```

        @Override
        public void run()
        {
            while(!stopped)
                System.out.println("running");
        }

        void stopThread()
        {
            stopped = true;
        }
    }
    StoppableThread thd = new StoppableThread();
    thd.start();
    try
    {
        Thread.sleep(1000); // sleep for 1 second
    }
    catch (InterruptedException ie)
    {
    }
    thd.stopThread();
}
}

```

Listing 7-20 introduces a `main()` method with a local class named `StoppableThread` that subclasses `Thread`. `StoppableThread` declares a `stopped` field initialized to `false`, a `stopThread()` method that sets this field to `true`, and a `run()` method whose infinite loop checks `stopped` on each loop iteration to see if its value has changed to `true`.

After instantiating `StoppableThread`, the default main thread starts the thread associated with this `Thread` object. It then sleeps for one second and calls `StoppableThread`'s `stop()` method before dying. When you run this application on a single-processor/single-core machine, you will probably observe the application stopping. You might not see this stoppage when the application runs on a multiprocessor machine or a uniprocessor machine with multiple cores where each processor or core probably has its own cache with its own copy of `stopped`. When one thread modifies its copy of this field, the other thread's copy of `stopped` isn't changed.

Listing 7-21 refactors Listing 7-20 to guarantee that the application will run correctly on all kinds of machines.

**Listing 7-21. Guaranteed Stoppage on a Multiprocessor/Multicore Machine**

```

public class ThreadStopping
{
    public static void main(String[] args)
    {
        class StoppableThread extends Thread
        {
            private boolean stopped = false;

```

```

    @Override
    public void run()
    {
        while(!isStopped())
            System.out.println("running");
    }

    synchronized void stopThread()
    {
        stopped = true;
    }

    private synchronized boolean isStopped()
    {
        return stopped;
    }
}
StoppableThread thd = new StoppableThread();
thd.start();
try
{
    Thread.sleep(1000); // sleep for 1 second
}
catch (InterruptedException ie)
{
}
thd.stopThread();
}
}

```

Listing 7-21's `stopThread()` and `isStopped()` methods are synchronized to support visibility so that the default main thread that calls `stopThread()` and the started thread that executes inside `run()` can communicate. When a thread enters one of these methods, it's guaranteed to access a single shared copy of the `stopped` field (not a cached copy).

Synchronization gives us mutual exclusion and visibility. Because you don't need mutual exclusion in this example (there is no race condition), you can refactor Listing 7-21 to take advantage of Java's `volatile` reserved word, which supports visibility only, and which Listing 7-22 demonstrates.

*Listing 7-22. The volatile Alternative to Synchronization*

```

public class ThreadStopping
{
    public static void main(String[] args)
    {
        class StoppableThread extends Thread
        {
            private volatile boolean stopped = false;

            @Override
            public void run()

```

```

        {
            while(!stopped)
                System.out.println("running");
        }

        void stopThread()
        {
            stopped = true;
        }
    }
    StoppableThread thd = new StoppableThread();
    thd.start();
    try
    {
        Thread.sleep(1000); // sleep for 1 second
    }
    catch (InterruptedException ie)
    {
    }
    thd.stopThread();
}
}

```

Listing 7-22 declares `stopped` to be `volatile`. Threads that access this field will always access a single shared copy (not cached copies on multiprocessor/multicore machines).

When a field is declared `volatile`, it cannot also be declared `final`. If you're depending on the *semantics* (meaning) of volatility, you still get those from a `final` field. For more information, check out Brian Goetz's "Java theory and practice: Fixing the Java Memory Model, Part 2" article ([www.ibm.com/developerworks/library/j-jtp03304/](http://www.ibm.com/developerworks/library/j-jtp03304/)).

**Caution** Use `volatile` only in a thread communication context. Also, you can only use this reserved word in the context of field declarations. Although you can declare `double` and `long` fields `volatile`, you should avoid doing so on 32-bit virtual machines because it takes two operations to access a `double` or `long` variable's value, and mutual exclusion (via synchronization) is required to access their values safely.

## Waiting and Notification

The `java.lang.Object` class provides `wait()`, `notify()`, and `notifyAll()` methods to support a form of thread communication where a thread voluntarily waits for some *condition* (a prerequisite for continued execution) to arise, at which time another thread notifies the waiting thread that it can continue. `wait()` causes its calling thread to wait on an object's monitor, and `notify()` and `notifyAll()` wake up one or all threads waiting on the monitor.

**Caution** Because the `wait()`, `notify()`, and `notifyAll()` methods depend on a lock, they cannot be called from outside of a synchronized method or synchronized block. If you fail to heed this warning, you will encounter a thrown instance of the `java.lang.IllegalMonitorStateException` class. Also, a thread that has acquired a lock releases this lock when it calls one of `Object`'s `wait()` methods.

A classic example of thread communication involving conditions is the relationship between a producer thread and a consumer thread. The producer thread produces data items to be consumed by the consumer thread. Each produced data item is stored in a shared variable.

Imagine that the threads are running at different speeds. The producer might produce a new data item and record it in the shared variable before the consumer retrieves the previous data item for processing. Also, the consumer might retrieve the contents of the shared variable before a new data item is produced.

To overcome those problems, the producer thread must wait until it is notified that the previously produced data item has been consumed, and the consumer thread must wait until it is notified that a new data item has been produced. Listing 7-23 shows you how to accomplish this task via `wait()` and `notify()`.

*Listing 7-23. The Producer-Consumer Relationship, Version 1*

```
public class PC
{
    public static void main(String[] args)
    {
        Shared s = new Shared();
        new Producer(s).start();
        new Consumer(s).start();
    }
}

class Shared
{
    private char c = '\u0000';
    private boolean writeable = true;

    synchronized void setSharedChar(char c)
    {
        while (!writeable)
        {
            try
            {
                wait();
            }
            catch (InterruptedException e) {}
        }
        this.c = c;
    }
}
```

```
        writeable = false;
        notify();
    }

    synchronized char getSharedChar()
    {
        while (writeable)
            try
            {
                wait();
            }
            catch (InterruptedException e) {}
        writeable = true;
        notify();
        return c;
    }
}

class Producer extends Thread
{
    private Shared s;

    Producer(Shared s)
    {
        this.s = s;
    }

    @Override
    public void run()
    {
        for (char ch = 'A'; ch <= 'Z'; ch++)
        {
            s.setSharedChar(ch);
            System.out.println(ch + " produced by producer.");
        }
    }
}

class Consumer extends Thread
{
    private Shared s;

    Consumer(Shared s)
    {
        this.s = s;
    }

    @Override
    public void run()
    {
        char ch;
        do
```

```

    {
        ch = s.getSharedChar();
        System.out.println(ch + " consumed by consumer.");
    }
    while (ch != 'Z');
}
}

```

This application creates a `Shared` object and two threads that get a copy of the object's reference. The producer calls the object's `setSharedChar()` method to save each of 26 uppercase letters; the consumer calls the object's `getSharedChar()` method to acquire each letter.

The `writable` instance field tracks two conditions: the producer waiting on the consumer to consume a data item and the consumer waiting on the producer to produce a new data item. It helps coordinate execution of the producer and consumer. The following scenario, where the consumer executes first, illustrates this coordination:

1. The consumer executes `s.getSharedChar()` to retrieve a letter.
2. Inside of that synchronized method, the consumer calls `wait()` because `writable` contains `true`. The consumer now waits until it receives notification from the producer.
3. The producer eventually executes `s.setSharedChar(ch);`.
4. When the producer enters that synchronized method (which is possible because the consumer released the lock inside of the `wait()` method prior to waiting), the producer discovers `writable`'s value to be `true` and doesn't call `wait()`.
5. The producer saves the character, sets `writable` to `false` (which will cause the producer to wait on the next `setSharedChar()` call when the consumer has not consumed the character by that time), and calls `notify()` to awaken the consumer (assuming the consumer is waiting).
6. The producer exits `setSharedChar(char c)`.
7. The consumer wakes up (and reacquires the lock), sets `writable` to `true` (which will cause the consumer to wait on the next `getSharedChar()` call when the producer has not produced a character by that time), notifies the producer to awaken that thread (assuming the producer is waiting), and returns the shared character.

Although the synchronization works correctly, you might observe output (on some platforms) that shows multiple producing messages before multiple consuming messages. For example, you might see `A produced by producer.`, followed by `B produced by producer.`, followed by `A consumed by consumer.`, at the beginning of the application's output.

This strange output order is caused by the call to `setSharedChar()` followed by its companion `System.out.println()` method call not being atomic, and by the call to `getSharedChar()` followed by its companion `System.out.println()` method call not being atomic. The output order can be



corrected by wrapping each of these method call pairs in a synchronized block that synchronizes on the Shared object referenced by s. Listing 7-24 presents this enhancement.

*Listing 7-24. The Producer-Consumer Relationship, Version 2*

```
public class PC
{
    public static void main(String[] args)
    {
        Shared s = new Shared();
        new Producer(s).start();
        new Consumer(s).start();
    }
}

class Shared
{
    private char c = '\u0000';
    private boolean writeable = true;

    synchronized void setSharedChar(char c)
    {
        while (!writeable)
            try
            {
                wait();
            }
            catch (InterruptedException e) {}
        this.c = c;
        writeable = false;
        notify();
    }

    synchronized char getSharedChar()
    {
        while (writeable)
            try
            {
                wait();
            }
            catch (InterruptedException e) {}
        writeable = true;
        notify();
        return c;
    }
}

class Producer extends Thread
{
    private Shared s;
```

```

Producer(Shared s)
{
    this.s = s;
}

@Override
public void run()
{
    for (char ch = 'A'; ch <= 'Z'; ch++)
    {
        synchronized(s)
        {
            s.setSharedChar(ch);
            System.out.println(ch + " produced by producer.");
        }
    }
}
}
class Consumer extends Thread
{
    private Shared s;

    Consumer(Shared s)
    {
        this.s = s;
    }

    @Override
    public void run()
    {
        char ch;
        do
        {
            synchronized(s)
            {
                ch = s.getSharedChar();
                System.out.println(ch + " consumed by consumer.");
            }
        }
        while (ch != 'Z');
    }
}
}

```

Compile Listing 7-24 (`javac PC.java`) and run this application (`java PC`). Its output should always appear in the same alternating order as shown next (only the first few lines are shown for brevity):

```

A produced by producer.
A consumed by consumer.
B produced by producer.
B consumed by consumer.
C produced by producer.

```

C consumed by consumer.  
 D produced by producer.  
 D consumed by consumer.

**Caution** Never call `wait()` outside of a loop. The loop tests the condition (`!writeable` or `writeable` in the previous example) before and after the `wait()` call. Testing the condition before calling `wait()` ensures *liveness*. If this test was not present, and if the condition held and `notify()` had been called prior to `wait()` being called, it is unlikely that the waiting thread would ever wake up. Retesting the condition after calling `wait()` ensures *safety*. If retesting didn't occur, and if the condition didn't hold after the thread had awakened from the `wait()` call (perhaps another thread called `notify()` accidentally when the condition didn't hold), the thread would proceed to destroy the lock's protected invariants.

## Deadlock

Too much synchronization can be problematic. If you are not careful, you might encounter a situation where locks are acquired by multiple threads, neither thread holds its own lock but holds the lock needed by some other thread, and neither thread can enter and later exit its critical section to release its held lock because some other thread holds the lock to that critical section. Listing 7-25's atypical example demonstrates this scenario, which is known as *deadlock*.

*Listing 7-25. A Pathological Case of Deadlock*

```
public class DeadlockDemo
{
    private Object lock1 = new Object();
    private Object lock2 = new Object();

    public void instanceMethod1()
    {
        synchronized(lock1)
        {
            synchronized(lock2)
            {
                System.out.println("first thread in instanceMethod1");
                // critical section guarded first by
                // lock1 and then by lock2
            }
        }
    }

    public void instanceMethod2()
    {
        synchronized(lock2)
        {
            synchronized(lock1)
            {
                System.out.println("second thread in instanceMethod2");
            }
        }
    }
}
```

```

        // critical section guarded first by
        // lock2 and then by lock1
    }
}

public static void main(String[] args)
{
    final DeadlockDemo dld = new DeadlockDemo();
    Runnable r1 = new Runnable()
    {
        @Override
        public void run()
        {
            while(true)
            {
                dld.instanceMethod1();
                try
                {
                    Thread.sleep(50);
                }
                catch (InterruptedException ie)
                {
                }
            }
        }
    };
    Thread thdA = new Thread(r1);
    Runnable r2 = new Runnable()
    {
        @Override
        public void run()
        {
            while(true)
            {
                dld.instanceMethod2();
                try
                {
                    Thread.sleep(50);
                }
                catch (InterruptedException ie)
                {
                }
            }
        }
    };
    Thread thdB = new Thread(r2);
    thdA.start();
    thdB.start();
}
}

```

Listing 7-25's thread A and thread B call `instanceMethod1()` and `instanceMethod2()`, respectively, at different times. Consider the following execution sequence:

1. Thread A calls `instanceMethod1()`, obtains the lock assigned to the `lock1`-referenced object, and enters its outer critical section (but has not yet acquired the lock assigned to the `lock2`-referenced object).
2. Thread B calls `instanceMethod2()`, obtains the lock assigned to the `lock2`-referenced object, and enters its outer critical section (but has not yet acquired the lock assigned to the `lock1`-referenced object).
3. Thread A attempts to acquire the lock associated with `lock2`. The virtual machine forces the thread to wait outside of the inner critical section because thread B holds that lock.
4. Thread B attempts to acquire the lock associated with `lock1`. The virtual machine forces the thread to wait outside of the inner critical section because thread A holds that lock.
5. Neither thread can proceed because the other thread holds the needed lock. You have a deadlock situation and the program (at least in the context of the two threads) freezes up.

Although the previous example clearly identifies a deadlock state, it's often not that easy to detect deadlock. For example, your code might contain the following circular relationship among various classes (in several source files):

- Class A's synchronized method calls class B's synchronized method.
- Class B's synchronized method calls class C's synchronized method.
- Class C's synchronized method calls class A's synchronized method.

If thread A calls class A's synchronized method and thread B calls class C's synchronized method, thread B will block when it attempts to call class A's synchronized method and thread A is still inside of that method. Thread A will continue to execute until it calls class C's synchronized method, and then block. Deadlock is the result.

**Note** Neither the Java language nor the virtual machine provides a way to prevent deadlock, and so the burden falls on you. The simplest way to prevent deadlock from happening is to avoid having either a synchronized method or a synchronized block call another synchronized method/block. Although this advice prevents deadlock from happening, it is impractical because one of your synchronized methods/blocks might need to call a synchronized method in a Java API, and the advice is overkill because the synchronized method/block being called might not call any other synchronized method/block, so deadlock would not occur.

## Thread-Local Variables

You will sometimes want to associate per-thread data (such a user ID) with a thread. Although you can accomplish this task with a local variable, you can only do so while the local variable exists. You could use an instance field to keep this data around longer, but then you would have to deal with synchronization. Thankfully, Java supplies `ThreadLocal` as a simple (and very handy) alternative.

Each instance of the `ThreadLocal` class describes a *thread-local variable*, which is a variable that provides a separate storage slot to each thread that accesses the variable. You can think of a thread-local variable as a multislot variable in which each thread can store a different value in the same variable. Each thread sees only its value and is unaware of other threads having their own values in this variable.

`ThreadLocal` is generically declared as `ThreadLocal<T>`, where `T` identifies the type of value that is stored in the variable. This class declares the following constructor and methods:

- `ThreadLocal()` creates a new thread-local variable.
- `T get()` returns the value in the calling thread's storage slot. If an entry doesn't exist when the thread calls this method, `get()` calls `initialValue()`.
- `T initialValue()` creates the calling thread's storage slot and stores an initial (default) value in this slot. The initial value defaults to null. You must subclass `ThreadLocal` and override this protected method to provide a more suitable initial value.
- `void remove()` removes the calling thread's storage slot. If this method is followed by `get()` with no intervening `set()`, `get()` calls `initialValue()`.
- `void set(T value)` sets the value of the calling thread's storage slot to `value`.

Listing 7-26 shows how to use `ThreadLocal` to associate different user IDs with two threads.

*Listing 7-26. Different User IDs for Different Threads*

```
public class ThreadLocalDemo
{
    private static volatile ThreadLocal<String> userID =
        new ThreadLocal<String>();

    public static void main(String[] args)
    {
        Runnable r = new Runnable()
        {
            @Override
            public void run()
            {
                String name = Thread.currentThread().getName();
                if (name.equals("A"))
                    userID.set("foxtrot");
                else
                    userID.set("charlie");
                System.out.println(name + " " + userID.get());
            }
        };
    }
};
```

```

    Thread thdA = new Thread(r);
    thdA.setName("A");
    Thread thdB = new Thread(r);
    thdB.setName("B");
    thdA.start();
    thdB.start();
}
}
}

```

After instantiating `ThreadLocal` and assigning the reference to a volatile class field named `userID` (the field is volatile because it is accessed by different threads, which might execute on a multiprocessor/multicore machine), the default main thread creates two more threads that store different `String` objects in `userID` and output their objects.

When you run this application, you will observe the following output (possibly not in this order):

```

A foxtrot
B charlie

```

Values stored in thread-local variables are not related. When a new thread is created, it gets a new storage slot containing `initialValue()`'s value. Perhaps you would prefer to pass a value from a *parent thread*, a thread that creates another thread, to a *child thread*, the created thread. You accomplish this task with `InheritableThreadLocal`.

`InheritableThreadLocal` is a subclass of `ThreadLocal`. As well as declaring an `InheritableThreadLocal()` constructor, this class declares the following protected method:

- `T childValue(T parentValue)` calculates the child's initial value as a function of the parent's value at the time the child thread is created. This method is called from the parent thread before the child thread is started. The method returns the argument passed to `parentValue` and should be overridden when another value is desired.

Listing 7-27 shows how to use `InheritableThreadLocal` to pass a parent thread's `Integer` object to a child thread.

**Listing 7-27. Passing an Object from Parent Thread to Child Thread**

```

public class InheritableThreadLocalDemo
{
    private static volatile InheritableThreadLocal<Integer> intVal =
        new InheritableThreadLocal<Integer>();

    public static void main(String[] args)
    {
        Runnable rP = new Runnable()
        {
            @Override
            public void run()
            {
                intVal.set(new Integer(10));
                Runnable rC = new Runnable()

```

```

        {
            @Override
            public void run()
            {
                Thread thd;
                thd = Thread.currentThread();
                String name = thd.getName();
                System.out.println(name + " " +
                                   intval.get());
            }
        };
        Thread thdChild = new Thread(rC);
        thdChild.setName("Child");
        thdChild.start();
    }
};
new Thread(rP).start();
}
}
}

```

After instantiating `InheritableThreadLocal` and assigning it to a volatile class field named `intval`, the default main thread creates a parent thread, which stores an `Integer` object containing 10 in `intval`. The parent thread creates a child thread, which accesses `intval` and retrieves its parent thread's `Integer` object.

When you run this application, you will observe the following output:

```
Child 10
```

**Note** For more insight into `ThreadLocal` and how it is implemented, check out Patson Luk's "A Painless Introduction to Java's `ThreadLocal` Storage" blog post (<http://java.dzone.com/articles/painless-introduction-javas-threadlocal-storage>).

## EXERCISES

The following exercises are designed to test your understanding of Chapter 7's content.

1. What constants does `Math` declare?
2. Why is `Math.abs(Integer.MIN_VALUE)` equal to `Integer.MIN_VALUE`?
3. What does `Math.random()` method accomplish? Why is expression `(int) Math.random() * limit` incorrect?
4. Identify the five special values that can arise during floating-point calculations.
5. How do `Math` and `StrictMath` differ?
6. What is the purpose of `strictfp`?



7. What is `BigDecimal` and why might you use this class?
8. Which `RoundingMode` constant describes the form of rounding commonly taught at school?
9. What is `BigInteger`?
10. What is a primitive type wrapper class?
11. Identify Java's primitive type wrapper classes.
12. Why does Java provide primitive type wrapper classes?
13. True or false: `Byte` is the smallest of the primitive type wrapper classes.
14. Why should you use `Character` class methods instead of expressions such as `ch >= '0' && ch <= '9'` to determine whether or not a character is a digit, a letter, and so on?
15. How do you determine whether or not `double` variable `d` contains `+infinity` or `-infinity`?
16. Identify the class that is the superclass of `Byte`, `Character`, and the other primitive type wrapper classes.
17. True or false: A string literal is a `String` object.
18. What is the purpose of `String`'s `intern()` method?
19. How do `String` and `StringBuffer` differ?
20. How do `StringBuffer` and `StringBuilder` differ?
21. What `System` method do you invoke to copy an array to another array?
22. What `System` method do you invoke to obtain the current time in milliseconds?
23. Define thread.
24. What is the purpose of the `Runnable` interface?
25. What is the purpose of the `Thread` class?
26. True or false: A `Thread` object associates with multiple threads.
27. Define race condition.
28. What is synchronization?
29. How is synchronization implemented?
30. How does synchronization work?
31. True or false: Variables of type `long` or `double` are not atomic on 32-bit virtual machines.
32. What is the purpose of reserved word `volatile`?
33. True or false: `Object`'s `wait()` methods can be called from outside of a synchronized method or block.
34. Define deadlock.
35. What is the purpose of the `ThreadLocal` class?
36. How does `InheritableThreadLocal` differ from `ThreadLocal`?

37. A *prime number* is a positive integer greater than 1 that is evenly divisible only by 1 and itself. Create a `PrimeNumberTest` application that determines if its solitary integer argument is prime or not prime, and outputs a suitable message. For example, `java PrimeNumberTest 289` should output the message `289 is not prime`. A simple way to check for primality is to loop from 2 through the square root of the integer argument, and use the remainder operator in the loop to determine if the argument is divided evenly by the loop index. For example, because `6 % 2` yields a remainder of 0 (2 divides evenly into 6), integer 6 is not a prime number.
38. Create a `MultiPrint` application that takes two arguments: text and an integer value that represents a count. This application should print count copies of the text, one copy per line.
39. Rewrite the following inefficient loop to use `StringBuffer`. The resulting loop should minimize object creation:

```
String[] imageNames = new String[NUM_IMAGES];
for (int i = 0; i < imageNames.length; i++)
    imageNames[i] = new String("image" + i + ".png");
```

40. Create a `DigitsToWords` application that accepts a single integer-based command-line argument. This application converts this argument to an `int` value (via `Integer.parseInt(args[0])`) and then passes the result to a `String convertDigitsToWords(int integer)` class method that returns a string containing a textual representation of that number. For example, 1 converts to one, 16 converts to sixteen, 69 converts to sixty-nine, 123 converts to one hundred and twenty-three, and 2938 converts to two thousand nine hundred and thirty-eight. Throw `java.lang.IllegalArgumentException` when the value passed to `integer` is less than 0 or greater than 9999. Use the `StringBuffer` class to serve as a repository for the generated text. Usage example: `java DigitsToWords 2938`.
  41. Create an `EVDump` application that dumps all environment variables (not system properties) to the standard output.
  42. Modify Listing 7-13's `CountingThreads` application by marking the two started threads as daemon threads. What happens when you run the resulting application?
  43. Modify Listing 7-13's `CountingThreads` application by adding logic to stop both counting threads when the user presses the Return/Enter key. The default main thread of the new `StopCountingThreads` application should call `System.in.read()` before terminating, and assign `true` to a variable named `stopped` after this method call returns. At each loop iteration start, each counting thread should test this variable to see if it contains `true`, and only continue the loop when the variable contains `false`.
-

## Summary

The standard class library offers many basic APIs via its `java.lang` and other packages. For example, the `Math` class supplements the basic math operations (+, -, \*, /, and %) with advanced operations (such as trigonometry). The companion `StrictMath` class ensures that all of these operations yield the same values on all platforms.

The abstract `java.lang.Number` class is the superclass of those classes representing numeric values that are convertible to the byte integer, double precision floating-point, floating-point, integer, long integer, and short integer primitive types.

Money must never be represented by floating-point and double precision floating-point variables because not all monetary values can be represented exactly. In contrast, `Number`'s `BigDecimal` subclass lets you accurately represent and manipulate these values.

`BigDecimal` relies on `Number`'s `BigInteger` subclass for representing its unscaled value. A `BigInteger` instance describes an integer value that can be of arbitrary length (subject to the limits of the virtual machine's memory).

`Number`'s `Boolean`, `Byte`, `Character`, `Double`, `Float`, `Integer`, `Long`, and `Short` subclasses are known as *primitive type wrapper classes* or *value classes* because their instances wrap themselves around values of primitive types.

Java provides these eight primitive type wrapper classes so that primitive type values can be stored in collections, such as lists, sets, and maps. Furthermore, these classes provide a good place to associate useful constants and class methods with the primitive types.

`String` represents a string as a sequence of characters. Because `String` instances are immutable, Java provides `StringBuffer` and `StringBuilder` for building strings more efficiently. The former class is used in multithreaded contexts; the latter (and more performant) class is for single-threaded use.

Applications execute via threads that serve as independent paths of execution through an application's code. The virtual machine gives each thread its own method-call stack to prevent threads from interfering with each other.

Java supports threads via its `Threads` API. This API largely consists of one interface (`Runnable`) and four classes (`Thread`, `ThreadGroup`, `ThreadLocal`, and `InheritableThreadLocal`) in the `java.lang` package. `ThreadGroup` is not as useful as these other types.

Throughout its execution, each thread is isolated from other threads because it has been given its own method-call stack. However, threads can still interfere with each other when they access and manipulate shared data. This interference can corrupt the shared data, causing an application to fail.

Corruption can be avoided by using synchronization so that only one thread at a time can execute inside a critical section, a region of code that must execute atomically. It is identified at the source code level as a synchronized method or a synchronized block.

You synchronize access at the method level by adding reserved word `synchronized` to the method header prior to the method's return type. You can also synchronize access to a block of statements by specifying a synchronized block via the following syntax: `synchronized(object) { /* statements */ }`.

Synchronization supports mutual exclusion and is implemented in terms of monitors and locks. A monitor controls access to a critical section and a lock must be acquired by a thread before the monitor will allow the thread to execute inside the monitor's critical section.

Synchronization also supports visibility in which a thread always sees the main memory value and not a cached value of a shared variable. There exists an alternative to synchronization when only visibility is required. This alternative is reserved word `volatile`.

Object's `wait()`, `notify()`, and `notifyAll()` methods support a form of thread communication where a thread voluntarily waits for some condition to arise, at which time another thread notifies the waiting thread that it can continue. `wait()` causes its calling thread to wait on an object's monitor, and `notify()` and `notifyAll()` wake up one or all threads waiting on the monitor.

Too much synchronization can be problematic. If you are not careful, you might encounter a situation where locks are acquired by multiple threads, neither thread holds its own lock but holds the lock needed by some other thread, and neither thread can enter and later exit its critical section to release its held lock because some other thread holds the lock to that critical section. This scenario is known as deadlock.

You will sometimes want to associate per-thread data with a thread. Although you can accomplish this task with a local variable, you can only do so while the local variable exists. You could use an instance field to keep this data around longer, but then you would have to deal with synchronization. Java supplies the `ThreadLocal` class as a simple (and very handy) alternative.

Each `ThreadLocal` instance describes a thread-local variable that provides a separate storage slot to each thread that accesses the variable. Think of a thread-local variable as a multislot variable in which each thread can store a different value in the same variable. Each thread sees only its value and is unaware of other threads having their own values in this variable.

Values stored in thread-local variables are not related. When a new thread is created, it gets a new storage slot containing `initialValue()`'s value. However, you can pass a value from a parent thread to a child thread by working with the `InheritableThreadLocal` class.

Chapter 8 continues to explore the basic APIs by focusing on `Random`, `References`, `Reflection`, `StringTokenizer`, and `Timer` and `TimerTask`.

# Exploring the Basic APIs, Part 2

There are more basic APIs in the `java.lang` package and also in `java.lang.ref`, `java.lang.reflect`, and `java.util` to consider for your Android apps. For example, you can add timers to your games.

## Exploring Random

In Chapter 7, I formally introduced you to the `java.lang.Math` class's `random()` method. If you were to investigate this method's source code from the perspective of Java 7, you would encounter the following implementation:

```
private static Random randomNumberGenerator;

private static synchronized Random initRNG() {
    Random rnd = randomNumberGenerator;
    return (rnd == null) ? (randomNumberGenerator = new Random()) : rnd;
}

public static double random() {
    Random rnd = randomNumberGenerator;
    if (rnd == null) rnd = initRNG();
    return rnd.nextDouble();
}
```

This code excerpt shows you that `Math`'s `random()` method is implemented in terms of a class named `Random`, which is located in the `java.util` package. `Random` instances generate sequences of random numbers and are known as *random number generators*.

**Note** These numbers are not truly random because they are generated from a mathematical algorithm. As a result, they are often referred to as *pseudorandom numbers*. However, it is often convenient to drop the “pseudo” prefix and refer to them as random numbers. Also, delaying object creation (`new Random()`, for example) until the first time the object is needed is known as *lazy initialization*.

`Random` generates its sequence of random numbers by starting with a special 48-bit value that is known as a *seed*. This value is subsequently modified by a mathematical algorithm, which is known as a *linear congruential generator*.

**Note** Check out Wikipedia’s “Linear congruential generator” entry ([http://en.wikipedia.org/wiki/Linear\\_congruential\\_generator](http://en.wikipedia.org/wiki/Linear_congruential_generator)) to learn about this algorithm for generating random numbers.

`Random` declares a pair of constructors:

- `Random()` creates a new random number generator. This constructor sets the seed of the random number generator to a value that is very likely to be distinct from any other call to this constructor.
- `Random(long seed)` creates a new random number generator using its `seed` argument. This argument is the initial value of the internal state of the random number generator, which is maintained by the protected `int next(int bits)` method.

Because `Random()` doesn’t take a `seed` argument, the resulting random number generator always generates a different sequence of random numbers. This explains why `Math.random()` generates a different sequence each time an application starts running.

**Tip** `Random(long seed)` gives you the opportunity to reuse the same seed value, allowing the same sequence of random numbers to be generated. You will find this capability useful when debugging a faulty application that involves random numbers.

`Random(long seed)` calls the void `setSeed(long seed)` method to set the seed to the specified value. If you call `setSeed()` after instantiating `Random`, the random number generator is reset to the state that it was in immediately after calling `Random(long seed)`.

The previous code excerpt demonstrates `Random`’s double `nextDouble()` method, which returns the next pseudorandom, uniformly distributed double precision floating-point value between 0.0 and 1.0 in this random number generator’s sequence.

`Random` also declares the following methods for returning other kinds of values:

- `boolean nextBoolean()` returns the next pseudorandom, uniformly distributed Boolean value in this random number generator’s sequence. Values `true` and `false` are generated with (approximately) equal probability.

- `void nextBytes(byte[] bytes)` generates pseudorandom byte integer values and stores them in the bytes array. The number of generated bytes is equal to the length of the bytes array.
- `float nextFloat()` returns the next pseudorandom, uniformly distributed floating-point value between 0.0 and 1.0 in this random number generator's sequence.
- `double nextGaussian()` returns the next pseudorandom, *Gaussian* (“normally”) distributed double precision floating-point value with mean 0.0 and standard deviation 1.0 in this random number generator's sequence.
- `int nextInt()` returns the next pseudorandom, uniformly distributed integer value in this random number generator's sequence. All 4,294,967,296 possible integer values are generated with (approximately) equal probability.
- `int nextInt(int n)` returns a pseudorandom, uniformly distributed integer value between 0 (inclusive) and the specified value (exclusive) drawn from this random number generator's sequence. All *n* possible integer values are generated with (approximately) equal probability.
- `long nextLong()` returns the next pseudorandom, uniformly distributed long integer value in this random number generator's sequence. Because `Random` uses a seed with only 48 bits, this method will not return all possible 64-bit long integer values.

The `java.util.Collections` class declares a pair of `shuffle()` methods for shuffling the contents of a list. In contrast, the `java.util.Arrays` class doesn't declare a `shuffle()` method for shuffling the contents of an array. Listing 8-1 addresses this omission.

**Listing 8-1. Shuffling an Array of Integers**

```
import java.util.Random;

public class Shuffler
{
    public static void main(String[] args)
    {
        Random r = new Random();
        int[] array = { 0, 1, 2, 3, 4, 5, 6, 7, 8, 9 };
        for (int i = 0; i < array.length; i++)
        {
            int n = r.nextInt(array.length);
            // swap array[i] with array[n]
            int temp = array[i];
            array[i] = array[n];
            array[n] = temp;
        }
        for (int i = 0; i < array.length; i++)
            System.out.print(array[i] + " ");
        System.out.println();
    }
}
```

Listing 8-1 presents a simple recipe for shuffling an array of integers—this recipe could be generalized. For each array entry from the start of the array to the end of the array, this entry is swapped with another entry whose index is chosen by `int nextInt(int n)`.

When you run this application, you will observe a shuffled sequence of integers that is similar to the following sequence that I observed:

```
9 0 5 6 2 3 8 4 1 7
```

## Exploring References

Chapter 3 introduced you to garbage collection in which you learned that the garbage collector removes an object from the heap when there are no more references to the object. This statement isn't completely true, as you will shortly discover.

Chapter 4 introduced you to `Object`'s `finalize()` method in which you learned that the garbage collector calls this method before removing an object from the heap. The `finalize()` method gives the object an opportunity to perform cleanup.

This section continues from where Chapters 3 and 4 left off by introducing you to Java's References API. After acquainting you with some basic terminology, it introduces you to the API's `Reference` and `ReferenceQueue` classes, followed by the API's `SoftReference`, `WeakReference`, and `PhantomReference` classes. These classes let applications interact with the garbage collector in limited ways.

**Note** As well as this section, you will find Brian Goetz's "Java theory and practice: Plugging memory leaks with soft references" ([www.ibm.com/developerworks/java/library/j-jtp01246/index.html](http://www.ibm.com/developerworks/java/library/j-jtp01246/index.html)) and "Java theory and practice: Plugging memory leaks with weak references" ([www.ibm.com/developerworks/java/library/j-jtp11225/index.html](http://www.ibm.com/developerworks/java/library/j-jtp11225/index.html)) tutorials to be helpful in understanding the References API.

## Basic Terminology

When an application runs, its execution reveals a *root set of references*, which is a collection of local variables, parameters, class fields, and instance fields that currently exist and that contain (possibly null) references to objects. This root set changes over time as the application runs. For example, parameters disappear after a method returns.

Many garbage collectors identify this root set when they run. They use the root set to determine if an object is *reachable* (referenced, also known as *live*) or *unreachable* (not referenced). The garbage collector cannot collect reachable objects. Instead, it can only collect objects that, starting from the root set of references, cannot be reached.

**Note** Reachable objects include objects that are indirectly reachable from root-set variables, which means objects that are reachable through live objects that are directly reachable from those variables. An object that is unreachable by any path from any root-set variable is eligible for garbage collection.



Beginning with Java 1.2, reachable objects are classified as strongly reachable, softly reachable, weakly reachable, and phantom reachable. Unlike strongly reachable objects, softly, weakly, and phantom reachable objects can be garbage collected.

Going from strongest to weakest, the different levels of reachability reflect the life cycle of an object. They are defined as follows:

- An object is *strongly reachable* when it can be reached from some thread without traversing any Reference objects. A newly created object (such as the object referenced by `d` in `Double d = new Double(1.0);`) is strongly reachable by the thread that created it.
- An object is *softly reachable* when it's not strongly reachable but can be reached by traversing a *soft reference* (a reference to the object where the reference is stored in a `SoftReference` object). The strongest reference to this object is a soft reference. When the soft references to a softly reachable object are cleared, the object becomes eligible for finalization (discussed in Chapter 4).
- An object is *weakly reachable* when it's neither strongly reachable nor softly reachable but can be reached by traversing a *weak reference* (a reference to the object where the reference is stored in a `WeakReference` object). The strongest reference to this object is a weak reference. When the weak references to a weakly reachable object are cleared, the object becomes eligible for finalization. (Apart from the garbage collector being more eager to clean up the weakly reachable object, a weak reference is exactly like a soft reference.)
- An object is *phantom reachable* when it's neither strongly, softly, nor weakly reachable, it has been finalized, and it's referred to by some *phantom reference* (a reference to the object where the reference is stored in a `PhantomReference` object). The strongest reference to this object is a phantom reference.
- Finally, an object is unreachable and therefore eligible for removal from memory during the next garbage collection cycle when it's not reachable in any of the above ways.

The object whose reference is stored in a `SoftReference`, `WeakReference`, or `PhantomReference` object is known as a *referent*.

## Reference and ReferenceQueue

The References API consists of five classes located in the `java.lang.ref` package. Central to this package are `Reference` and `ReferenceQueue`

- `Reference` is the abstract superclass of this package's concrete `SoftReference`, `WeakReference`, and `PhantomReference` subclasses.
- `ReferenceQueue` is a concrete class whose instances describe queue data structures. When you associate a `ReferenceQueue` instance with a `Reference` subclass object (`Reference` object, for short), the `Reference` object is added to the queue when the referent to which its encapsulated reference refers becomes garbage.

**Note** You associate a `ReferenceQueue` object with a `Reference` object by passing the `ReferenceQueue` object to an appropriate `Reference` subclass constructor.

`Reference` is declared as generic type `Reference<T>` where `T` identifies the referent's type. This class provides the following methods:

- `void clear()` assigns null to the stored reference; the `Reference` object on which this method is called isn't *enqueued* (inserted) into its associated reference queue (when there is an associated reference queue). (The garbage collector clears references directly; it doesn't call `clear()`. Instead, this method is called by applications.)
- `boolean enqueue()` adds the `Reference` object on which this method is called to the associated reference queue. This method returns true when this `Reference` object has become enqueued; otherwise, this method returns false—this `Reference` object was already enqueued or was not associated with a queue when created. (The garbage collector enqueues `Reference` objects directly; it doesn't call `enqueue()`. Instead, this method is called by applications.)
- `T get()` returns this `Reference` object's stored reference. The return value is null when the stored reference has been cleared, either by the application or by the garbage collector.
- `boolean isEnqueued()` returns true when this `Reference` object has been enqueued, either by the application or by the garbage collector. Otherwise, this method returns false—this `Reference` object was not associated with a queue when created.

**Note** `Reference` also declares constructors. Because these constructors are package-private, only classes in the `java.lang.ref` package can subclass `Reference`. This restriction is necessary because instances of `Reference`'s subclasses must work closely with the garbage collector.

`ReferenceQueue` is declared as generic type `ReferenceQueue<T>` where `T` identifies the referent's type. This class declares the following constructor and methods:

- `ReferenceQueue()` initializes a new `ReferenceQueue` instance.
- `Reference<? extends T> poll()` polls this queue to check for an available `Reference` object. When one is available, the object is removed from the queue and returned. Otherwise, this method returns immediately with a null value.
- `Reference<? extends T> remove()` removes the next `Reference` object from the queue and returns this object. This method waits indefinitely for a `Reference` object to become available and throws `java.lang.InterruptedException` when this wait is interrupted.

- `Reference<T> remove(long timeout)` removes the next `Reference` object from the queue and returns this object. This method waits until a `Reference` object becomes available or until `timeout` milliseconds have elapsed—passing 0 to `timeout` causes the method to wait indefinitely. If `timeout`'s value expires, the method returns null. This method throws `java.lang.IllegalArgumentException` when `timeout`'s value is negative or `InterruptedException` when this wait is interrupted.

## SoftReference

The `SoftReference` class describes a `Reference` object whose referent is softly reachable. As well as inheriting `Reference`'s methods and overriding `get()`, this generic class provides the following constructors for initializing a `SoftReference` object:

- `SoftReference(T r)` encapsulates `r`'s reference. The `SoftReference` object behaves as a soft reference to `r`. No `ReferenceQueue` object is associated with this `SoftReference` object.
- `SoftReference(T r, ReferenceQueue<? super T> rq)` encapsulates `r`'s reference. The `SoftReference` object behaves as a soft reference to `r`. The `ReferenceQueue` object identified by `rq` is associated with this `SoftReference` object. Passing null to `rq` indicates a soft reference without a queue.

`SoftReference` is useful for implementing caches of objects that are expensive timewise to create (such as a database connection) and/or occupy significant amounts of heap space, such as large images. I'll present an example when I discuss the Collection Framework's `java.util.HashMap` class (in Chapter 9).

## WeakReference

The `WeakReference` class describes a `Reference` object whose referent is weakly reachable. As well as inheriting `Reference`'s methods, this generic class provides the following constructors for initializing a `WeakReference` object:

- `WeakReference(T r)` encapsulates `r`'s reference. The `WeakReference` object behaves as a weak reference to `r`. No `ReferenceQueue` object is associated with this `WeakReference` object.
- `WeakReference(T r, ReferenceQueue<? super T> rq)` encapsulates `r`'s reference. The `WeakReference` object behaves as a weak reference to `r`. The `ReferenceQueue` object identified by `rq` is associated with this `WeakReference` object. Passing null to `rq` indicates a weak reference without a queue.

`WeakReference` is useful for preventing memory leaks related to hashmaps and is used to implement the Collection Framework's `java.util.WeakHashMap` class. I'll have more to say about this topic when I discuss `WeakHashMap` (in Chapter 9).

## PhantomReference

The `PhantomReference` class describes a `Reference` object whose referent is phantom reachable. As well as inheriting `Reference`'s methods and overriding `get()`, this generic class provides a single constructor for initializing a `PhantomReference` object:

- `PhantomReference(T r, ReferenceQueue<? super T> rq)` encapsulates `r`'s reference. The `PhantomReference` object behaves as a phantom reference to `r`. The `ReferenceQueue` object identified by `rq` is associated with this `PhantomReference` object. Passing `null` to `rq` makes no sense because `get()` is overridden to return `null` and the `PhantomReference` object will never be enqueued.

Although you cannot access a `PhantomReference` object's referent (its `get()` method returns `null`), this class is useful because enqueueing the `PhantomReference` object signals that the referent has been finalized and its memory space has been reclaimed. For example, you can learn that a large object has been removed from memory and then load another large object into memory without having to worry about an out-of-memory error.

Another use for `PhantomReference` is to avoid the following problem: an object's `finalize()` method can resurrect the object by creating a new strong reference to the object. Because of this resurrection potential, the garbage collector requires at least two garbage collection cycles to determine if the object can be garbage collected. When the first cycle detects that the object is eligible for garbage collection, it calls `finalize()`. Because this method might perform resurrection (see Chapter 4), which makes the unreachable object reachable, a second garbage collection cycle is needed to determine if resurrection has happened. This extra cycle slows down garbage collection and has the potential to result in an out-of-memory error. If `finalize()` isn't overridden, the garbage collector doesn't need to call that method and considers the object to be finalized. Hence, the garbage collector requires only one cycle.

You can avoid the need for `finalize()` and its performance implications/out-of-memory error potential by using `PhantomReference`. Resurrection cannot happen because the reference queue's `get()` method returns `null`. Listing 8-2 shows how you might use `PhantomReference` to detect the finalization of a large object.

### *Listing 8-2. Detecting a Large Object's Finalization*

```
import java.lang.ref.PhantomReference;
import java.lang.ref.ReferenceQueue;

class LargeObject
{
    private byte[] memory = new byte[1024 * 1024 * 50]; // 50 megabytes
}

public class PhantomReferenceDemo
{
    public static void main(String[] args)
    {
        ReferenceQueue<LargeObject> rq = new ReferenceQueue<LargeObject>();
        PhantomReference<LargeObject> pr;
        pr = new PhantomReference<LargeObject>(new LargeObject(), rq);
    }
}
```

```

while (rq.poll() == null)
{
    System.out.println("waiting for first large object to be finalized");
    new LargeObject(); // Create another (unreferenced) LargeObject.
}
System.out.println("first large object finalized");
System.out.println("pr.get() returns " + pr.get());
}
}
}

```

Listing 8-2 declares a `LargeObject` class whose private memory array occupies 50MB. If your virtual machine throws `java.lang.OutOfMemoryError` when you run this application, you might need to reduce the array's size.

The `main()` method first creates a `ReferenceQueue` object describing a queue onto which a `PhantomReference` object that initially contains a `LargeObject` reference will be enqueued. It then creates the `PhantomReference` object, passing a reference to a newly created `LargeObject` instance and a reference to the previously created `ReferenceQueue` object to the constructor.

`main()` now enters a polling loop, which first calls `poll()` to detect the finalization of the `LargeObject` instance. As long as this method returns null, meaning that the `LargeObject` instance is still unfinalized, the loop outputs a message and creates a new unreferenced `LargeObject` instance.

At some point, the garbage collector will run. It will clear the `PhantomReference` object's `LargeObject` reference and finalize the `LargeObject` object. The `PhantomReference` object is then enqueued onto the `rq`-referenced `ReferenceQueue`; `poll()` returns the `PhantomReference` object.

`main()` now exits the loop, outputs a message confirming the large object's finalization, and outputs `pr.get()`'s return value, which is null—proving that you cannot access a `PhantomReference` object's referent.

Compile Listing 8-2 (`javac PhantomReferenceDemo.java`) and run the application (`java PhantomReferenceDemo`). You should discover output that's similar to the following output:

```

waiting for first large object to be finalized
waiting for first large object to be finalized
waiting for first large object to be finalized
waiting for first large object to be finalized
waiting for first large object to be finalized
waiting for first large object to be finalized
waiting for first large object to be finalized
waiting for first large object to be finalized
waiting for first large object to be finalized
waiting for first large object to be finalized
waiting for first large object to be finalized
waiting for first large object to be finalized
waiting for first large object to be finalized
waiting for first large object to be finalized
waiting for first large object to be finalized
waiting for first large object to be finalized
waiting for first large object to be finalized
waiting for first large object to be finalized

```

```

waiting for first large object to be finalized
waiting for first large object to be finalized
waiting for first large object to be finalized
waiting for first large object to be finalized
waiting for first large object to be finalized
waiting for first large object to be finalized
waiting for first large object to be finalized
first large object finalized
pr.get() returns null

```

**Note** For a more useful example of `PhantomReference`, check out Keith D Gregory's "Java Reference Objects" blog post ([www.kdgregory.com/index.php?page=java.refobjj](http://www.kdgregory.com/index.php?page=java.refobjj)).

## Exploring Reflection

Chapter 4 presented two forms of runtime type identification (RTTI). Java's Reflection API offers a third RTTI form in which applications can dynamically load and learn about loaded classes and other reference types. The API also lets applications instantiate classes, call methods, access fields, and perform other tasks reflectively. This form of RTTI is known as *reflection* or *introspection*.

**Caution** Reflection should not be used indiscriminately. Application performance suffers because it takes longer to perform operations with reflection than without reflection. Also, reflection-oriented code can be harder to read, and the absence of compile-time type checking can result in runtime failures.

Chapter 6 presented a `StubFinder` application that used part of the Reflection API to load a class and identify all of the loaded class's public methods that are annotated with `@Stub` annotations. This tool is one example where using reflection is beneficial. Another example is the *class browser*, a tool that enumerates the members of a class.

**Note** You'll occasionally use the Reflection API in your Android app projects. For example, reflection simplifies the task of coding an app to use newer APIs when available. For more information, check out "Backward compatibility for Android applications" (<http://android-developers.blogspot.ca/2009/04/backward-compatibility-for-android.html>).

## The Class Entry Point

The `java.lang` package's `Class` class is the entry point into the Reflection API, whose types are stored mainly in the `java.lang.reflect` package. `Class` is generically declared as `Class<T>`, where `T` identifies the class, interface, enum, or annotation type that's being modeled by the `Class` object. `T` can be replaced by `?` (as in `Class<?>`) when the type being modeled is unknown.

Table 8-1 describes some of `Class`'s methods.

**Table 8-1. Class Methods**

Method	Description
<code>static Class&lt;?&gt; forName(String typename)</code>	Returns the <code>Class</code> object associated with <code>typename</code> , which must include the type's qualified package name when the type is part of a package ( <code>java.lang.String</code> , for example). If the class or interface type has not been loaded into memory, this method takes care of <i>loading</i> (reading the classfile's contents into memory), <i>linking</i> (taking these contents and combining them into the runtime state of the virtual machine so that they can be executed), and <i>initializing</i> (setting class fields to default values, running class initializers, and performing other class initialization) before returning the <code>Class</code> object. This method throws <code>java.lang.ClassNotFoundException</code> when the type cannot be found, <code>java.lang.LinkageError</code> when an error occurs during linkage, and <code>java.lang.ExceptionInInitializerError</code> when an exception occurs during a class's static initialization.
<code>Annotation[] getAnnotations()</code>	Returns an array (that's possibly empty) containing all annotations that are declared for the class represented by this <code>Class</code> object.
<code>Class&lt;?&gt;[] getClasses()</code>	Returns an array containing <code>Class</code> objects representing all public classes and interfaces that are members of the class represented by this <code>Class</code> object. This includes public class and interface members inherited from superclasses and public class and interface members declared by the class. This method returns a zero-length array when this <code>Class</code> object has no public member classes or interfaces. This method also returns a zero-length array when this <code>Class</code> object represents a primitive type, an array class, or <code>void</code> .
<code>Constructor[] getConstructors()</code>	Returns an array containing <code>java.lang.reflect.Constructor</code> objects representing all the public constructors of the class represented by this <code>Class</code> object. A zero-length array is returned when the represented class has no public constructors, this <code>Class</code> object represents an array class, or this <code>Class</code> object represents a primitive type or <code>void</code> .
<code>Annotation[] getDeclaredAnnotations()</code>	Returns an array containing all annotations that are directly declared on the class represented by this <code>Class</code> object; inherited annotations are not included. The returned array might be empty.
<code>Class&lt;?&gt;[] getDeclaredClasses()</code>	Returns an array of <code>Class</code> objects representing all classes and interfaces declared as members of the class represented by this <code>Class</code> object. This includes public, protected, default (package) access, and private classes and interfaces. This method returns a zero-length array when the class declares no classes or interfaces as members, or when this <code>Class</code> object represents a primitive type, an array class, or <code>void</code> .

(continued)

Table 8-1. (continued)

Method	Description
Constructor[] getDeclaredConstructors()	Returns an array of <code>Constructor</code> objects representing all constructors declared by the class represented by this <code>Class</code> object. These are public, protected, default (package) access, and private constructors. The returned array's elements are not sorted and are not in any order. If the class has a default constructor, it's included in the returned array. This method returns a zero-length array when this <code>Class</code> object represents an interface, a primitive type, an array class, or void.
Field[] getDeclaredFields()	Returns an array of <code>java.lang.reflect.Field</code> objects representing all fields declared by the class or interface represented by this <code>Class</code> object. This array includes public, protected, default (package) access, and private fields, but excludes inherited fields. The returned array's elements are not sorted and are not in any order. This method returns a zero-length array when the class/interface declares no fields, or when this <code>Class</code> object represents a primitive type, an array class, or void.
Method[] getDeclaredMethods()	Returns an array of <code>java.lang.reflect.Method</code> objects representing all methods declared by the class or interface represented by this <code>Class</code> object. This array includes public, protected, default (package) access, and private methods, but excludes inherited methods. The elements in the returned array are not sorted and are not in any order. This method returns a zero-length array when the class or interface declares no methods, or when this <code>Class</code> object represents a primitive type, an array class, or void.
Field[] getFields()	Returns an array containing <code>Field</code> objects representing all public fields of the class or interface represented by this <code>Class</code> object, including those public fields inherited from superclasses and superinterfaces. The elements in the returned array are not sorted and are not in any order. This method returns a zero-length array when this <code>Class</code> object represents a class or interface that has no accessible public fields, or when this <code>Class</code> object represents an array class, a primitive type, or void.
Method[] getMethods()	Returns an array containing <code>Method</code> objects representing all public methods of the class or interface represented by this <code>Class</code> object, including those public methods inherited from superclasses and superinterfaces. Array classes return all the public member methods inherited from the <code>java.lang.Object</code> class. The elements in the returned array are not sorted and are not in any order. This method returns a zero-length array when this <code>Class</code> object represents a class or interface that has no public methods, or when this <code>Class</code> object represents a primitive type or void. The class initialization method <code>&lt;clinit&gt;()</code> (see Chapter 3) isn't included in the returned array.

(continued)



**Table 8-1.** (continued)

Method	Description
<code>int getModifiers()</code>	<p>Returns the Java language modifiers for this class or interface, encoded in an integer. The modifiers consist of the virtual machine's constants for <code>public</code>, <code>protected</code>, <code>private</code>, <code>final</code>, <code>static</code>, <code>abstract</code>, and <code>interface</code>; they should be decoded using the methods of class <code>java.lang.reflect.Modifier</code>.</p> <p>If the underlying class is an array class, its <code>public</code>, <code>private</code>, and <code>protected</code> modifiers are the same as those of its component type. If this <code>Class</code> object represents a primitive type or <code>void</code>, its <code>public</code> modifier is always true, and its <code>protected</code> and <code>private</code> modifiers are always false. If this <code>Class</code> object represents an array class, a primitive type, or <code>void</code>, its <code>final</code> modifier is always true and its <code>interface</code> modifier is always false. The values of its other modifiers are not determined by this specification.</p>
<code>String getName()</code>	Returns the name of the class represented by this <code>Class</code> object.
<code>Package getPackage()</code>	Returns a <code>java.lang.Package</code> object that describes the package in which the class represented by this <code>Class</code> object is located, or returns null when the class is a member of the unnamed package.
<code>Class&lt;? super T&gt; getSuperclass()</code>	Returns the <code>Class</code> object representing the superclass of the entity (class, interface, primitive type, or <code>void</code> ) represented by this <code>Class</code> object. When the <code>Class</code> object on which this method is called represents the <code>Object</code> class, an interface, a primitive type, or <code>void</code> , null is returned. When this object represents an array class, the <code>Class</code> object representing the <code>Object</code> class is returned.
<code>boolean isAnnotation()</code>	Returns true when this <code>Class</code> object represents an annotation type. If this method returns true, <code>isInterface()</code> also returns true because all annotation types are also interfaces.
<code>boolean isEnum()</code>	Returns true if and only if this class was declared as an enum in the source code.
<code>boolean isInterface()</code>	Returns true when this <code>Class</code> object represents an interface.
<code>T newInstance()</code>	Creates and returns a new instance of the class represented by this <code>Class</code> object. The class is instantiated as if by a <code>new</code> expression with an empty argument list. The class is initialized when it has not already been initialized. This method throws <code>java.lang.IllegalAccessException</code> when the class or its noargument constructor isn't accessible; <code>java.lang.InstantiationException</code> when this <code>Class</code> object represents an abstract class, an interface, an array class, a primitive type, or <code>void</code> , or when the class doesn't have a noargument constructor (or when instantiation fails for some other reason); and <code>ExceptionInInitializerError</code> when initialization fails because the object threw an exception during initialization.

Table 8-1 identifies the Constructor, Field, Method, and Modifier members of the `java.lang.reflect` package. It also identifies other reflection-oriented types that belong to other packages. For example, Annotation (the superinterface of Override, SuppressWarnings, and all other annotation types) is a member of `java.lang.annotation` and Package is a member of `java.lang`.

## Obtaining a Class Object

Table 8-1's description of the `forName()` method reveals one way to obtain a Class object. This method loads, links, and initializes a class or interface that isn't in memory and returns a Class object representing the class or interface. Listing 8-3 demonstrates `forName()` and additional methods described in this table.

*Listing 8-3. Using Reflection to Decompile a Type*

```
import java.lang.reflect.Constructor;
import java.lang.reflect.Field;
import java.lang.reflect.Method;
import java.lang.reflect.Modifier;

public class Decompiler
{
    public static void main(String[] args)
    {
        if (args.length != 1)
        {
            System.err.println("usage: java Decompiler classname");
            return;
        }
        try
        {
            decompileClass(Class.forName(args[0]), 0);
        }
        catch (ClassNotFoundException cnfe)
        {
            System.err.println("could not locate " + args[0]);
        }
    }

    static void decompileClass(Class<?> clazz, int indentLevel)
    {
        indent(indentLevel * 3);
        System.out.print(Modifier.toString(clazz.getModifiers()) + " ");
        if (clazz.isEnum())
            System.out.println("enum " + clazz.getName());
        else
            if (clazz.isInterface())
            {
                if (clazz.isAnnotation())
                    System.out.print("@");
                System.out.println(clazz.getName());
            }
    }
}
```

```

else
    System.out.println(clazz);
indent(indentLevel * 3);
System.out.println("{}");
Field[] fields = clazz.getDeclaredFields();
for (int i = 0; i < fields.length; i++)
{
    indent(indentLevel * 3);
    System.out.println("  " + fields[i]);
}
Constructor[] constructors = clazz.getDeclaredConstructors();
if (constructors.length != 0 && fields.length != 0)
    System.out.println();
for (int i = 0; i < constructors.length; i++)
{
    indent(indentLevel * 3);
    System.out.println("  "+constructors[i]);
}
Method[] methods = clazz.getDeclaredMethods();
if (methods.length != 0 &&
    (fields.length != 0 || constructors.length != 0))
    System.out.println();
for (int i = 0; i < methods.length; i++)
{
    indent(indentLevel * 3);
    System.out.println("  "+methods[i]);
}
Method[] methodsAll = clazz.getMethods();
if (methodsAll.length != 0 &&
    (fields.length != 0 || constructors.length != 0 ||
    methods.length != 0))
    System.out.println();
if (methodsAll.length != 0)
{
    indent(indentLevel * 3);
    System.out.println("  ALL PUBLIC METHODS");
    System.out.println();
}
for (int i = 0; i < methodsAll.length; i++)
{
    indent(indentLevel * 3);
    System.out.println("  "+methodsAll[i]);
}
Class<?>[] members = clazz.getDeclaredClasses();
if (members.length != 0 && (fields.length != 0 ||
    constructors.length != 0 || methods.length != 0 ||
    methodsAll.length != 0))
    System.out.println();
for (int i = 0; i < members.length; i++)
    if (clazz != members[i])

```

```

        {
            decompileClass(members[i], indentLevel + 1);
            if (i != members.length - 1)
                System.out.println();
        }
        indent(indentLevel * 3);
        System.out.println("");
    }

    static void indent(int numSpaces)
    {
        for (int i = 0; i < numSpaces; i++)
            System.out.print(' ');
    }
}

```

Listing 8-3 presents the source code to a decompiler tool that uses reflection to obtain information about the command-line argument, which must be a Java reference type (a class, for example). The decompiler outputs the type and name information for a class's fields, constructors, methods, and nested types. It also outputs the members of interfaces, enums, and annotation types.

After verifying that one command-line argument has been passed to this application, `main()` calls `forName()` to return a `Class` object representing the class or interface identified by this argument.

`forName()` throws an instance of the checked `ClassNotFoundException` class when it cannot locate the class's classfile (perhaps the classfile was erased before executing the application). It also throws `LinkageError` when a class's classfile is malformed and `ExceptionInInitializerError` when a class's static initialization fails.

**Note** `ExceptionInInitializerError` is often thrown as the result of a class initializer throwing an unchecked exception. For example, the class initializer in the following `FailedInitialization` class results in `ExceptionInInitializerError` because `someMethod()` throws `java.lang.NullPointerException`:

```

public class FailedInitialization
{
    static
    {
        someMethod(null);
    }

    public static void someMethod(String s)
    {
        int len = s.length(); // s contains null
        System.out.println(s + "'s length is " + len + " characters");
    }
}

```

Assuming that `forName()` is successful, the returned object's reference is passed to `decompileClass()`, which decompiles the type. (`decompileClass()` is recursive in that it invokes itself for every encountered nested type.)

The `decompileClass()` method invokes `Class`'s `getModifiers()`, `isEnum()`, `getName()`, `isInterface()`, `isAnnotation()`, `getDeclaredFields()`, `getDeclaredConstructors()`, `getDeclaredMethods()`, `getMethods()`, and `getDeclaredClasses()` methods to return different pieces of information about the loaded class or interface, which is subsequently output.

Much of the printing code focuses on making the output look nice as if it was a source code listing. The code manages indentation and only allows a newline character to be output to separate one section from another; a newline character isn't output unless content appears before and after the newline.

Compile Listing 8-3 (`javac Decompiler.java`) and run this application with `java.lang.Byte` as the solitary command-line argument (`java Decompiler java.lang.Byte`). You will observe the following output, which provides insight into how `Byte` is implemented:

```
public final class java.lang.Byte
{
    public static final byte java.lang.Byte.MIN_VALUE
    public static final byte java.lang.Byte.MAX_VALUE
    public static final java.lang.Class java.lang.Byte.TYPE
    private final byte java.lang.Byte.value
    public static final int java.lang.Byte.SIZE
    private static final long java.lang.Byte.serialVersionUID

    public java.lang.Byte(byte)
    public java.lang.Byte(java.lang.String) throws java.lang.NumberFormatException

    public boolean java.lang.Byte.equals(java.lang.Object)
    public java.lang.String java.lang.Byte.toString()
    public static java.lang.String java.lang.Byte.toString(byte)
    public int java.lang.Byte.hashCode()
    public int java.lang.Byte.compareTo(java.lang.Byte)
    public int java.lang.Byte.compareTo(java.lang.Object)
    public byte java.lang.Byte.byteValue()
    public short java.lang.Byte.shortValue()
    public int java.lang.Byte.intValue()
    public long java.lang.Byte.longValue()
    public float java.lang.Byte.floatValue()
    public double java.lang.Byte.doubleValue()
    public static java.lang.Byte java.lang.Byte.valueOf(byte)
    public static java.lang.Byte java.lang.Byte.valueOf(java.lang.String) throws java.lang.
NumberFormatException
    public static java.lang.Byte java.lang.Byte.valueOf(java.lang.String,int) throws java.lang.
NumberFormatException
    public static int java.lang.Byte.compare(byte,byte)
    public static java.lang.Byte java.lang.Byte.decode(java.lang.String) throws java.lang.
NumberFormatException
    public static byte java.lang.Byte.parseByte(java.lang.String) throws java.lang.
NumberFormatException
    public static byte java.lang.Byte.parseByte(java.lang.String,int) throws java.lang.
NumberFormatException
```

## ALL PUBLIC METHODS

```

public boolean java.lang.Byte.equals(java.lang.Object)
public java.lang.String java.lang.Byte.toString()
public static java.lang.String java.lang.Byte.toString(byte)
public int java.lang.Byte.hashCode()
public int java.lang.Byte.compareTo(java.lang.Byte)
public int java.lang.Byte.compareTo(java.lang.Object)
public byte java.lang.Byte.byteValue()
public short java.lang.Byte.shortValue()
public int java.lang.Byte.intValue()
public long java.lang.Byte.longValue()
public float java.lang.Byte.floatValue()
public double java.lang.Byte.doubleValue()
public static java.lang.Byte java.lang.Byte.valueOf(byte)
public static java.lang.Byte java.lang.Byte.valueOf(java.lang.String) throws java.lang.
NumberFormatException
public static java.lang.Byte java.lang.Byte.valueOf(java.lang.String,int) throws java.lang.
NumberFormatException
public static int java.lang.Byte.compare(byte,byte)
public static java.lang.Byte java.lang.Byte.decode(java.lang.String) throws java.lang.
NumberFormatException
public static byte java.lang.Byte.parseByte(java.lang.String) throws java.lang.
NumberFormatException
public static byte java.lang.Byte.parseByte(java.lang.String,int) throws java.lang.
NumberFormatException
public final void java.lang.Object.wait() throws java.lang.InterruptedException
public final void java.lang.Object.wait(long,int) throws java.lang.InterruptedException
public final native void java.lang.Object.wait(long) throws java.lang.InterruptedException
public final native java.lang.Class java.lang.Object.getClass()
public final native void java.lang.Object.notify()
public final native void java.lang.Object.notifyAll()

```

```

private static class java.lang.Byte$ByteCache
{
    static final java.lang.Byte[] java.lang.Byte$ByteCache.cache

    private java.lang.Byte$ByteCache()

```

## ALL PUBLIC METHODS

```

public final void java.lang.Object.wait() throws java.lang.InterruptedException
public final void java.lang.Object.wait(long,int) throws java.lang.InterruptedException
public final native void java.lang.Object.wait(long) throws java.lang.InterruptedException
public boolean java.lang.Object.equals(java.lang.Object)
public java.lang.String java.lang.Object.toString()
public native int java.lang.Object.hashCode()
public final native java.lang.Class java.lang.Object.getClass()
public final native void java.lang.Object.notify()
public final native void java.lang.Object.notifyAll()
}
}

```

Another way to obtain a `Class` object is to call `Object`'s `getClass()` method on an object reference; for example, `Employee e = new Employee(); Class<? extends Employee> clazz = e.getClass();`. The `getClass()` method doesn't throw an exception because the class from which the object was created is already present in memory.

There is one more way to obtain a `Class` object, and that is to employ a *class literal*, which is an expression consisting of a class name, followed by a period separator that's followed by reserved word `class`. Examples of class literals include `Class<Employee> clazz = Employee.class;` and `Class<String> clazz = String.class.`

Perhaps you're wondering about how to choose between `forName()`, `getClass()`, and a class literal. To help you make your choice, the following list compares each competitor:

- `forName()` is very flexible in that you can dynamically specify any reference type by its package-qualified name. If the type isn't in memory, it's loaded, linked, and initialized. However, lack of compile-time type safety can lead to runtime failures.
- `getClass()` returns a `Class` object describing the type of its referenced object. When called on a superclass variable containing a subclass instance, a `Class` object representing the subclass type is returned. Because the class is in memory, type safety is assured.
- A class literal returns a `Class` object representing its specified class. Class literals are compact and the compiler enforces type safety by refusing to compile the source code when it cannot locate the literal's specified class.

**Note** You can use class literals with primitive types, including `void`. Examples include `int.class`, `double.class`, and `void.class`. The returned `Class` object represents the class identified by a primitive type wrapper class's `TYPE` field or `java.lang.Void.TYPE`. For example, each of `int.class == java.lang.Integer.TYPE` and `void.class == Void.TYPE` evaluates to `true`.

You can also use class literals with primitive type-based arrays. Examples include `int[].class` and `double[].class`. For these examples, the returned `Class` objects represent `Class<int[]>` and `Class<double[]>`.

## Instantiating a Dynamically Loaded Class

One of Table 8-1's methods not demonstrated in Listing 8-3 is `newInstance()`, which is useful for instantiating a dynamically loaded class provided that the class has a noargument constructor. The following code fragment demonstrates this:

```
try
{
    Class<?> clazz = Class.forName("codecs.AVI");
    Codec codec = (Codec) clazz.newInstance();
    VideoPlayer player = new VideoPlayer(codec);
    player.play("movie.avi");
}
```

```

catch (ClassNotFoundException cnfe)
{
    cnfe.printStackTrace();
}
catch (IllegalAccessException iae)
{
    iae.printStackTrace();
}
catch (InstantiationException ie)
{
    ie.printStackTrace();
}

```

This code fragment uses `Class.forName()` to attempt to load a hypothetical Audio Video Interleave (AVI) compressor/decompressor (codec), which is stored as `AVI.class` in the `codecs` package. If successful, the codec is instantiated via the `newInstance()` method. A hypothetical `VideoPlayer` class is instantiated and its instance is initialized to the codec, and the player is told to play the contents of `movie.avi`, which was encoded via this codec.

`forName()` throws `ClassNotFoundException` when it cannot find `AVI.class`. `newInstance()` throws `IllegalAccessException` when it cannot locate a noargument constructor in `AVI.class` and `InstantiationException` when instantiation fails (perhaps the classfile describes an interface or an abstract class).

## Constructor, Field, and Method

Table 8-1's method descriptions refer to `Constructor`, `Field`, and `Method`. Instances of these classes represent a class's constructors and a class's or an interface's fields and methods.

`Constructor` represents a constructor and is generically declared as `Constructor<T>` where `T` identifies the class in which the constructor represented by `Constructor` is declared. `Constructor` declares various methods including the following methods:

- `Annotation[] getDeclaredAnnotations()` returns an array of all annotations declared on the constructor. The returned array has zero length when there are no annotations.
- `Class<T> getDeclaringClass()` returns a `Class` object that represents the class in which the constructor is declared.
- `Class[]<?> getExceptionTypes()` returns an array of `Class` objects representing the types of exceptions listed in the constructor's `throws` clause. The returned array has zero length when there is no `throws` clause.
- `String getName()` returns the constructor's name.
- `Class[]<?> getParameterTypes()` returns an array of `Class` objects representing the constructor's parameter types, in declaration order. The returned array has zero length when the constructor declares no parameters.



**Tip** If you want to instantiate a class via a constructor that takes arguments, you cannot use `Class`'s `newInstance()` method. Instead, you must use `Constructor`'s `newInstance(Object... initargs)` method to perform this task. Unlike `Class`'s `newInstance()` method, which bypasses the compile-time exception checking that would otherwise be performed by the compiler, `Constructor`'s `newInstance()` method avoids this problem by wrapping any exception thrown by the constructor in an instance of the `java.lang.reflect.InvocationTargetException` class.

`Field` represents a field and declares various methods including the following getter methods:

- `Object getObject(Object object)` returns the value of the field for the specified object.
- `boolean getBoolean(Object object)` returns the value of the Boolean field for the specified object.
- `byte getByte(Object object)` returns the value of the byte integer field for the specified object.
- `char getChar(Object object)` returns the value of the character field for the specified object.
- `double getDouble(Object object)` returns the value of the double precision floating-point field for the specified object.
- `float getFloat(Object object)` returns the value of the floating-point field for the specified object.
- `int getInt(Object object)` returns the value of the integer field for the specified object.
- `long getLong(Object object)` returns the value of the long integer field for the specified object.
- `short getShort(Object object)` returns the value of the short integer field for the specified object.

`get()` returns the value of any type of field. In contrast, the other listed methods return the values of specific types of fields. These methods throw a `NullPointerException` instance when `object` is `null` and the field is an instance field, an `IllegalArgumentException` instance when `object` is not an instance of the class or interface declaring the underlying field (or not an instance of a subclass or interface implementor), and an `IllegalAccessException` instance when the underlying field cannot be accessed (perhaps the field is private).

Listing 8-4 demonstrates `Field`'s `getInt(Object)` and `getDouble(Object)` methods along with their `void setInt(Object obj, int i)` and `void setDouble(Object obj, double d)` counterparts.

*Listing 8-4. Reflectively Getting and Setting the Values of Instance and Class Fields*

```
import java.lang.reflect.Field;

class X
{
    public int i = 10;
    public static final double PI = 3.14;
}

public class FieldAccessDemo
{
    public static void main(String[] args)
    {
        try
        {
            Class<?> clazz = Class.forName("X");
            X x = (X) clazz.newInstance();
            Field f = clazz.getField("i");
            System.out.println(f.getInt(x));           // Output: 10
            f.setInt(x, 20);
            System.out.println(f.getInt(x));           // Output: 20
            f = clazz.getField("PI");
            System.out.println(f.getDouble(null));    // Output: 3.14
            f.setDouble(x, 20);
            System.out.println(f.getDouble(null));    // Never executed
        }
        catch (Exception e)
        {
            System.err.println(e);
        }
    }
}
```

Listing 8-4 declares classes `X` and `FieldAccessDemo`. I've included `X`'s source code with `FieldAccessDemo`'s source code for convenience. However, you can imagine this source code being stored in a separate source file.

`FieldAccessDemo`'s `main()` method first attempts to load `X` and then tries to instantiate this class via `newInstance()`. If successful, the instance is assigned to reference variable `x`.

`main()` next invokes `Class`'s `Field` `getField(String name)` method to return a `Field` instance that represents the public field identified by name, which happens to be `i` (in the first case) and `PI` (in the second case). This method throws `java.lang.NoSuchFieldException` when the named field doesn't exist.

Continuing, `main()` invokes `Field`'s `getInt()` and `setInt()` methods (with an object reference) to get the instance field's initial value, change this value to another value, and get the new value. The initial and new values are output.

At this point, `main()` demonstrates class field access in a similar manner. However, it passes `null` to `getInt()` and `setInt()` because an object reference isn't required to access a class field. Because `PI` is declared `final`, the call to `setInt()` results in a thrown instance of the `IllegalAccessException` class.

**Note** I've specified `catch(Exception e)` to avoid having to specify multiple catch blocks.

Method represents a method and declares various methods, including the following methods:

- `int getModifiers()` returns a 32-bit integer whose bit fields identify the method's reserved word modifiers (such as `public`, `abstract`, or `static`). These bit fields must be interpreted via the `Modifier` class. For example, you might specify `(method.getModifiers() & Modifier.ABSTRACT) == Modifier.ABSTRACT` to find out if the method (represented by the `Method` object whose reference is stored in `method`) is abstract—this expression evaluates to true when the method is abstract.
- `Class<?> getReturnType()` returns a `Class` object that represents the method's return type.
- `Object invoke(Object receiver, Object... args)` calls the method on the object identified by `receiver` (which is ignored when the method is a class method), passing the variable number of arguments identified by `args` to the called method. The `invoke()` method throws `NullPointerException` when `receiver` is null and the method being invoked is an instance method, `IllegalAccessException` when the method isn't accessible (perhaps it's private), `IllegalArgumentException` when an incorrect number of arguments are passed to the method (and other reasons), and `InvocationTargetException` when an exception is thrown from the called method.
- `boolean isVarArgs()` returns true when the method is declared to receive a variable number of arguments.

Listing 8-5 demonstrates `Method`'s `invoke(Object, Object...)` method.

*Listing 8-5. Reflectively Invoking Instance and Class Methods*

```
import java.lang.reflect.Method;

class X
{
    public void objectMethod(String arg)
    {
        System.out.println("Instance method: " + arg);
    }

    public static void classMethod()
    {
        System.out.println("Class method");
    }
}
```

```

public class MethodInvocationDemo
{
    public static void main(String[] args)
    {
        try
        {
            Class<?> clazz = Class.forName("X");
            X x = (X) clazz.newInstance();
            Class[] argTypes = { String.class };
            Method method = clazz.getMethod("objectMethod", argTypes);
            Object[] data = { "Hello" };
            method.invoke(x, data); // Output: Instance method: Hello
            method = clazz.getMethod("classMethod", (Class<?>[]) null);
            method.invoke(null, (Object[]) null); // Output: Class method
        }
        catch (Exception e)
        {
            System.err.println(e);
        }
    }
}

```

Listing 8-5 declares classes `X` and `MethodInvocationDemo`. `MethodInvocationDemo`'s `main()` method first attempts to load `X` and then tries to instantiate this class via `newInstance()`. When successful, the instance is assigned to reference variable `x`.

`main()` next creates a one-element `Class` array that describes the types of `objectMethod()`'s parameter list. This array is used in the subsequent call to `Class`'s `getMethod(String name, Class<?>... parameterTypes)` method to return a `Method` object for invoking a public method named `objectMethod` with this parameter list. This method throws `java.lang.NoSuchMethodException` when the named method doesn't exist.

Continuing, `main()` creates an `Object` array that specifies the data to be passed to the method's parameters; in this case, the array consists of a single `String` argument. It then reflectively invokes `objectMethod()` by passing this array along with the object reference stored in `x` to the `invoke()` method.

At this point, `main()` shows you how to reflectively invoke a class method. The `(Class<?>[])` and `(Object[])` casts are used to suppress warning messages that have to do with variable numbers of arguments and null references. Notice that the first argument passed to `invoke()` is null when invoking a class method.

## Accessible Objects

The `java.lang.reflect.AccessibleObject` class is the superclass of `Constructor`, `Field`, and `Method`. This superclass provides annotation-related methods; and methods for reporting a constructor's, field's, or method's accessibility (is it private?) and making an inaccessible constructor, field, or method accessible. `AccessibleObject`'s methods include the following:

- `<T extends Annotation> T getAnnotation(Class<T> annotationType)` returns the constructor's, field's, or method's annotation of the specified type when such an annotation is present; otherwise, null returns.

- `boolean isAccessible()` returns true when the constructor, field, or method is accessible.
- `boolean isAnnotationPresent(Class<? extends Annotation> annotationType)` returns true when an annotation of the type specified by `annotationType` has been declared on the constructor, field, or method. This method takes inherited annotations into account.
- `void setAccessible(boolean flag)` attempts to make an inaccessible constructor, field, or method accessible when `flag` is true.

## Package

Table 8-1's method descriptions also referred to `Package`, a class that provides information about a package (see Chapter 5 for an introduction to packages). This information includes version details about the implementation and specification of a Java package, the name of the package, and an indication of whether or not the package has been *sealed* (all classes that are part of the package are archived in the same JAR file).

Table 8-2 describes some of `Package`'s methods.

**Table 8-2.** *Package Methods*

Method	Description
<code>String getImplementationTitle()</code>	Returns the title of this package's implementation, which might be null. The format of the title is unspecified.
<code>String getImplementationVendor()</code>	Returns the name of the vendor or organization that provides this package's implementation. This name might be null. The format of the name is unspecified.
<code>String getImplementationVersion()</code>	Returns the version number of this package's implementation, which might be null. This version string must be a sequence of positive decimal integers separated by periods and might have leading zeros.
<code>String getName()</code>	Returns the name of this package in standard dot notation; for example, <code>java.lang</code> .
<code>static Package getPackage(String packageName)</code>	Returns the <code>Package</code> object that is associated with the package identified as <code>packageName</code> or null when the package identified as <code>packageName</code> cannot be found. This method throws <code>NullPointerException</code> when <code>packageName</code> is null.
<code>static Package[] getPackages()</code>	Returns an array of all <code>Package</code> objects that are accessible to this method's caller.
<code>String getSpecificationTitle()</code>	Returns the title of this package's specification, which might be null. The format of the title is unspecified.
<code>String getSpecificationVendor()</code>	Returns the name of the vendor or organization that provides the specification that is implemented by this package. This name might be null. The format of the name is unspecified.

(continued)

**Table 8-2.** (continued)

Method	Description
String getSpecificationVersion()	Returns the version number of the specification of this package's implementation, which might be null. This version string must be a sequence of positive decimal integers separated by periods, and might have leading zeros.
boolean isCompatibleWith(String desired)	Checks this package to determine if it is compatible with the specified version string, by comparing this package's specification version with the desired version. Returns true when this package's specification version number is greater than or equal to the desired version number (this package is compatible); otherwise, returns false. This method throws <code>NullPointerException</code> when <code>desired</code> is null and <code>java.lang.NumberFormatException</code> when this package's version number or the desired version number is not in dotted form.
boolean isSealed()	Returns true when this package has been sealed; otherwise, returns false.

I have created a `PackageInfo` application that demonstrates most of Table 8-2's `Package` methods. Listing 8-6 presents this application's source code.

**Listing 8-6. Obtaining Information About a Package**

```
public class PackageInfo
{
    public static void main(String[] args)
    {
        if (args.length == 0)
        {
            System.err.println("usage: java PackageInfo packageName [version]");
            return;
        }
        Package pkg = Package.getPackage(args[0]);
        if (pkg == null)
        {
            System.err.println(args[0] + " not found");
            return;
        }
        System.out.println("Name: " + pkg.getName());
        System.out.println("Implementation title: " +
            pkg.getImplementationTitle());
        System.out.println("Implementation vendor: " +
            pkg.getImplementationVendor());
        System.out.println("Implementation version: " +
            pkg.getImplementationVersion());
        System.out.println("Specification title: " +
            pkg.getSpecificationTitle());
        System.out.println("Specification vendor: " +
            pkg.getSpecificationVendor());
    }
}
```

```

System.out.println("Specification version: " +
    pkg.getSpecificationVersion());
System.out.println("Sealed: " + pkg.isSealed());
if (args.length > 1)
    System.out.println("Compatible with " + args[1] + ": " +
        pkg.isCompatibleWith(args[1]));
}
}

```

After compiling Listing 8-6 (`javac PackageInfo.java`), specify at least a package name on the command line. For example, `java PackageInfo java.lang` returns the following output under Java 7:

```

Name: java.lang
Implementation title: Java Runtime Environment
Implementation vendor: Oracle Corporation
Implementation version: 1.7.0_06
Specification title: Java Platform API Specification
Specification vendor: Oracle Corporation
Specification version: 1.7
Sealed: false

```

`PackageInfo` also lets you determine if the package's specification is compatible with a specific version number. A package is compatible with its predecessors.

For example, `java PackageInfo java.lang 1.6` outputs `Compatible with 1.6: true`, whereas `java PackageInfo java.lang 1.8` outputs `Compatible with 1.8: false`.

You can also use `PackageInfo` with your own packages, which you learned to create in Chapter 5. For example, that chapter presented a logging package.

Copy `PackageInfo.class` into the directory containing the logging package directory (which contains the compiled classfiles), and execute the following command:

```
java PackageInfo logging
```

`PackageInfo` responds by displaying the following output:

```
logging not found
```

This error message is presented because `getPackage()` requires at least one classfile to be loaded from the package before it returns a `Package` object describing that package.

The only way to eliminate the previous error message is to load a class from the package. Accomplish this task by merging the following code fragment into Listing 8-6.

```

if (args.length == 3)
try
{
    Class.forName(args[2]);
}

```

```

catch (ClassNotFoundException cnfe)
{
    System.err.println("cannot load " + args[2]);
    return;
}

```

This code fragment, which must precede `Package pkg = Package.getPackage(args[0]);`, loads the classfile named by the revised `PackageInfo` application's third command-line argument.

Run the new `PackageInfo` application via `java PackageInfo logging 1.5 logging.File` and you will observe the following output, provided that `File.class` exists (you need to compile this package before specifying this command line)—this command line identifies logging's `File` class as the class to load:

```

Name: logging
Implementation title: null
Implementation vendor: null
Implementation version: null
Specification title: null
Specification vendor: null
Specification version: null
Sealed: false
Exception in thread "main" java.lang.NumberFormatException: Empty version string
    at java.lang.Package.isCompatibleWith(Unknown Source)
    at PackageInfo.main(PackageInfo.java:41)

```

It's not surprising to see all of these null values because no package information has been added to the logging package. Also, `NumberFormatException` is thrown from `isCompatibleWith()` because the logging package doesn't contain a specification version number in dotted form (it is null).

Perhaps the simplest way to place package information into the logging package is to create a `logging.jar` file in a similar manner to the example shown in Chapter 5. But first, you must create a small text file that contains the package information. You can choose any name for the file. Listing 8-7 reveals my choice of `manifest.mf`.

*Listing 8-7. manifest.mf Containing the Package Information*

```

Implementation-Title: Logging Implementation
Implementation-Vendor: Jeff Friesen
Implementation-Version: 1.0a
Specification-Title: Logging Specification
Specification-Vendor: Jeff "JavaJeff" Friesen
Specification-Version: 1.0
Sealed: true

```

**Note** Make sure to press the Return/Enter key at the end of the final line (`Sealed: true`). Otherwise, you will probably observe `Sealed: false` in the output because this entry will not be stored in the logging package by the JDK's `jar` tool; `jar` is a bit quirky.



Execute the following command line to create a JAR file that includes logging and its files, and whose *manifest*, a special file named MANIFEST.MF that stores information about the contents of a JAR file, contains the contents of Listing 8-7:

```
jar cfm logging.jar manifest.mf logging
```

Alternatively, specify one of the following slightly longer command lines, which are equivalent to the former command line:

```
jar cfm logging.jar manifest.mf logging\*.class  
jar cfm logging.jar manifest.mf logging/*.class
```

Either command line creates a JAR file named logging.jar (via the c [create] and f [file] options). It also merges the contents of manifest.mf (via the m [manifest] option) into MANIFEST.MF, which is stored in the package's/JAR's file META-INF directory.

**Note** To learn more about a JAR file's manifest, read the “JAR Manifest” section of the JDK documentation's “JAR File Specification” page ([http://docs.oracle.com/javase/7/docs/technotes/guides/jar/jar.html#JAR\\_Manifest](http://docs.oracle.com/javase/7/docs/technotes/guides/jar/jar.html#JAR_Manifest)).

Assuming that the jar tool presents no error messages, execute the following Windows-oriented command line (or a command line suitable for your platform) to run PackageInfo and extract the package information from the logging package:

```
java -cp logging.jar;. PackageInfo logging 1.0 logging.File
```

The -cp command-line option lets you specify the classpath, which consists of logging.jar and the current directory (represented by the dot [.] character). Fail to specify the dot and java outputs an error message complaining that it cannot locate PackageInfo.class.

This time, you should see the following output:

```
Name: logging  
Implementation title: Logging Implementation  
Implementation vendor: Jeff Friesen (IV)  
Implementation version: 1.0a  
Specification title: Logging Specification  
Specification vendor: Jeff Friesen (SV)  
Specification version: 1.0  
Sealed: true  
Compatible with 1.0: true
```

## Array

The `java.lang.reflect` package also includes an `Array` class whose class methods make it possible to reflectively create and access Java arrays. Listing 8-8 provides a demonstration.

*Listing 8-8. Reflectively Creating and Accessing an Array*

```
import java.lang.reflect.Array;

public class ArrayDemo
{
    public static void main(String[] args)
    {
        String[] argsCopy = (String[]) Array.newInstance(String.class, args.length);
        for (int i = 0; i < args.length; i++)
            Array.set(argsCopy, i, args[i]);
        for (int i = 0; i < args.length; i++)
            System.out.println(Array.get(argsCopy, i));
    }
}
```

Listing 8-8 first invokes `Array`'s `Object newInstance(Class<?> componentType, int length)` class method to create an array that can store `String` objects. It then copies all passed `String` arguments to this array, invoking `Array`'s `void set(Object array, int index, Object value)` class method to store each object. Finally, it retrieves each stored object by invoking `Array`'s `Object get(Object array, int index)` class method.

Compile Listing 8-8 (`javac ArrayDemo.java`) and run this application. For example, consider the following command:

```
java ArrayDemo a b c
```

This command generates the following output:

```
a
b
c
```

## Exploring StringTokenizer

You'll occasionally want to extract a string's individual components. For example, you have the string `"int x = 4;"` and want to extract `int`, `x`, `=`, `4`, and `;` separately. Alternatively, you might have a comma-separated values (CSV) file where each line consists of multiple data items separated by commas and you want to read each value separately.

The task of breaking up a string into its individual components is known as *parsing* or *tokenizing*. The components themselves are known as *tokens*. (Technically, a token is a category, such as identifier, and the component is known as a *lexeme*, such as `int`.)

Java 1.0 introduced the `java.util.StringTokenizer` class to let applications tokenize strings. `StringTokenizer` lets you specify a string to be tokenized and a set of *delimiters* that separate successive tokens. This class declares three constructors for specifying these items:

- `StringTokenizer(String str)` constructs a string tokenizer for the specified string. The tokenizer uses the default delimiter set, which is “\t\n\r\f”: the space character, the tab character, the newline character, the carriage-return character, and the form-feed character. Delimiter characters themselves won’t be treated as tokens. This constructor throws `NullPointerException` when you pass null to `str`.
- `StringTokenizer(String str, String delim)` constructs a string tokenizer for the specified string. The characters in the `delim` argument are the delimiters for separating tokens. Delimiter characters themselves won’t be treated as tokens. This constructor throws `NullPointerException` when you pass null to `str`. Although it doesn’t throw an exception when you pass null to `delim`, trying to invoke other methods on the resulting `StringTokenizer` instance may result in `NullPointerException`.
- `StringTokenizer(String str, String delim, boolean returnDelims)` constructs a string tokenizer for the specified string. All characters in the `delim` argument are the delimiters for separating tokens. When the `returnDelims` flag is true, the delimiter characters are also returned as tokens. Each delimiter is returned as a string of length one. When `returnDelims` is false, the delimiter characters are skipped and only serve as separators between tokens. This constructor throws `NullPointerException` when you pass null to `str`. Although it doesn’t throw an exception when you pass null to `delim`, invoking other methods on the resulting `StringTokenizer` instance may result in `NullPointerException`.

Additionally, `StringTokenizer` declares the following methods, which indicate that `StringTokenizer` instances maintain a current position for locating the next token:

- `int countTokens()` returns the number of times that this tokenizer’s `nextToken()` method can be called before it generates an exception. The current position is not advanced.
- `boolean hasMoreElements()` returns the same value as the `hasMoreTokens()` method. It exists because `StringTokenizer` implements the `java.util.Enumeration` interface (discussed in Chapter 9).
- `boolean hasMoreTokens()` returns true when more tokens are available from this tokenizer’s string; otherwise, it returns false. When this method returns true, a subsequent call to the noargument `nextToken()` method will successfully return a token.
- `Object nextElement()` returns the same value as the noargument `nextToken()` method, except that its return value is of type `Object` rather than `String`. It exists because `StringTokenizer` implements the `Enumeration` interface, and throws `java.util.NoSuchElementException` when there are no more tokens.
- `String nextToken()` returns the next token from this string tokenizer. It throws `NoSuchElementException` when there are no more tokens.

- `String nextToken(String delim)` returns the next token from this string tokenizer. First, the set of characters considered to be delimiters by this `StringTokenizer` object is changed to be the characters specified by `delim`. Then, the next token in the string after the current position is returned. The current position is advanced beyond the recognized token. The new delimiter set remains the default after this call. This method throws `NoSuchElementException` when there are no more tokens and `NullPointerException` when you pass null to `delim`.

You would typically use `StringTokenizer` in a loop context, as follows:

```
StringTokenizer st = new StringTokenizer("this is a test");
while (st.hasMoreTokens())
    System.out.println(st.nextToken());
```

This loop generates the following output:

```
this
is
a
test
```

Alternatively, you could specify the following loop context:

```
StringTokenizer st = new StringTokenizer("this is a test");
Enumeration e = (Enumeration) st;
while (e.hasMoreElements())
    System.out.println(e.nextElement());
```

This loop generates the following output:

```
this
is
a
test
```

Of course, you would have to cast `nextElement()`'s `Object` return type to `String` before assigning the result to a `String` variable.

**Note** `StringTokenizer` implements `Enumeration` so that you can create common code for enumerating tokens and legacy vector/hashtable (see Chapter 9) content.

Although you'll find `StringTokenizer` easy to use in your Android apps or non-Android Java programs, Java provides a more powerful alternative in the form of regular expressions (discussed in Chapter 13). To give you a taste for the power of regular expressions, you can easily bypass the previous loops for obtaining tokens by employing the following code fragment:

```
String[] values = "this is a test".split("\\s");
```

The `String` class declares `String[] split(String regex)` and `String[] split(String regex, int limit)` methods that let you split a string into components that are separated by delimiters identified by the specified regular expression (`regex`). For example, `\\s` represents the `\s` regular expression (backslashes must be doubled when placed in string literals), which stands for whitespace character. The string is split around whitespace character delimiters.

If you were to specify the following loop,

```
for (int i = 0; i < values.length; i++)
    System.out.println(values[i]);
```

you would observe the following output:

```
this
is
a
test
```

## Exploring Timer and TimerTask

It's often necessary to schedule a *task* (a unit of work) for *one-shot execution* (the task runs only once) or for repeated execution at regular intervals. For example, you might schedule an alarm clock task to run only once (perhaps to wake you up in the morning) or schedule a nightly backup task to run at regular intervals. With either kind of task, you might want the task to run at a specific time in the future or after an initial delay.

You can use the `Threads` API (see Chapter 7) to accomplish task scheduling. However, Java 1.3 introduced a more convenient and simpler alternative in the form of `java.util.Timer` and `java.util.TimerTask` classes.

**Note** Android apps can use `Timer` and `TimerTask` but these classes must work with Android's `android.os.Handler` class or the `android.app.Activity` class's `void runOnUiThread(Runnable action)` method when the timer needs to update the user interface, which must occur on the user interface thread. For more information, check out [stackoverflow's "Android timer? How?"](http://stackoverflow.com/questions/4597690/android-timer-how) topic (<http://stackoverflow.com/questions/4597690/android-timer-how>).

Timer provides a facility for scheduling `TimerTasks` for future execution on a background thread. Timer tasks may be scheduled for one-shot execution or for repeated execution at regular intervals. Before delving into the internals of these classes, check out Listing 8-9.

*Listing 8-9. Displaying the Current Millisecond Value at Approximately 1-Second Intervals*

```
import java.util.Timer;
import java.util.TimerTask;

public class TimerDemo
{
    public static void main(String[] args)
    {
        TimerTask task = new TimerTask()
        {
            @Override
            public void run()
            {
                System.out.println(System.currentTimeMillis());
            }
        };
        Timer timer = new Timer();
        timer.schedule(task, 0, 1000);
    }
}
```

Listing 8-9 describes an application that outputs the current time (in milliseconds) approximately every second. It first instantiates a `TimerTask` subclass (in this case, an anonymous class is used) whose overriding `run()` method outputs the time. It then instantiates `Timer` and invokes its `schedule()` method with this task as the first argument. The second and third arguments indicate that the task is scheduled for repeated execution after no initial delay and every 1000 milliseconds.

Compile Listing 8-9 (`javac TimerDemo.java`) and run this application (`java TimerDemo`). You should observe output that's similar to the following truncated output:

```
1380933893664
1380933894666
1380933895668
1380933896668
1380933897670
1380933898672
```

## Timer in Depth

Corresponding to each `Timer` object is a single background thread that's used to execute all of the timer tasks sequentially. This thread is known as the *task-execution thread*.

**Note** Timer scales to large numbers of concurrently scheduled timer tasks (thousands should present no problem). Internally, it uses a *binary heap* to represent its timer task queue so the cost to schedule a timer task is  $O(\log n)$ , where  $n$  is the number of concurrently scheduled timer tasks. Check out Wikipedia’s “Big O notation” topic ([http://en.wikipedia.org/wiki/Big\\_O\\_notation](http://en.wikipedia.org/wiki/Big_O_notation)) to learn more about  $O()$ .

Timer declares the following constructors:

- `Timer()` creates a new timer whose task-execution thread doesn’t run as a daemon thread.
- `Timer(boolean isDaemon)` creates a new timer whose task-execution thread may be specified to run as a daemon (pass `true` to `isDaemon`). A daemon thread is called for scenarios where the timer will be used to schedule repeating “maintenance activities”, which must be performed for as long as the application is running, but shouldn’t prolong the application’s lifetime.
- `Timer(String name)` creates a new timer whose task-execution thread has the specified name. The task-execution thread doesn’t run as a daemon thread. This constructor throws `NullPointerException` when `name` is `null`.
- `Timer(String name, boolean isDaemon)` creates a new timer whose task-execution thread has the specified name and which may run as a daemon thread. This constructor throws `NullPointerException` when `name` is `null`.

Timer also declares the following methods:

- `void cancel()` terminates this timer, discarding any currently scheduled timer tasks. This method doesn’t interfere with a currently executing timer task (when it exists). After a timer has been terminated, its execution thread terminates gracefully and no more timer tasks may be scheduled on it. (Calling `cancel()` from within the `run()` method of a timer task that was invoked by this timer absolutely guarantees that the ongoing task execution is the last task execution that will ever be performed by this timer.) This method may be called repeatedly; the second and subsequent calls have no effect.
- `int purge()` removes all canceled timer tasks from this timer’s queue, and returns the number of timer tasks that have been removed. Calling `purge()` has no effect on the behavior of the timer, but eliminates references to the canceled timer tasks from the queue. When there are no external references to these timer tasks, they become eligible for garbage collection. (Most applications won’t need to call this method, which is designed for use by the rare application that cancels a large number of timer tasks. Calling `purge()` trades time for space: this method’s runtime may be proportional to  $n + c * \log n$ , where  $n$  is the number of timer tasks in the queue and  $c$  is the number of canceled timer tasks.) It’s permissible to call `purge()` from within a timer task scheduled on this timer.
- `void schedule(TimerTask task, Date time)` schedules `task` for execution at `time`. When `time` is in the past, `task` is scheduled for immediate execution. This method throws `IllegalArgumentException` when `time.getTime()` is negative;

`java.lang.IllegalStateException` when task was already scheduled or canceled, the timer was canceled, or the task-execution thread terminated; and `NullPointerException` when task or time is null. (You'll learn about `java.util.Date` in Chapter 16.)

- `void schedule(TimerTask task, Date firstTime, long period)` schedules task for repeated fixed-delay execution, beginning at `firstTime`. Subsequent executions take place at approximately regular intervals, separated by `period` milliseconds. In *fixed-delay execution*, each execution is scheduled relative to the actual execution time of the previous execution. When an execution is delayed for any reason (such as garbage collection), subsequent executions are also delayed. In the long run, the frequency of execution will generally be slightly lower than the reciprocal of `period` (assuming the system clock underlying `Object.wait(long)` is accurate). As a consequence, when the scheduled `firstTime` value is in the past, task is scheduled for immediate execution. Fixed-delay execution is appropriate for recurring tasks that require “smoothness.” In other words, this form of execution is appropriate for tasks where it's more important to keep the frequency accurate in the short run than in the long run. This includes most animation tasks, such as blinking a cursor at regular intervals. It also includes tasks wherein regular activity is performed in response to human input, such as automatically repeating a character for as long as a key is held down. This method throws `IllegalArgumentException` when `firstTime.getTime()` is negative or `period` is negative or zero; `IllegalStateException` when task was already scheduled or canceled, the timer was canceled, or the task-execution thread terminated; and `NullPointerException` when task or `firstTime` is null.
- `void schedule(TimerTask task, long delay)` schedules task for execution after `delay` milliseconds. This method throws `IllegalArgumentException` when `delay` is negative or `delay + System.currentTimeMillis()` is negative; `IllegalStateException` when task was already scheduled or canceled, the timer was canceled, or the task-execution thread terminated; and `NullPointerException` when task is null.
- `void schedule(TimerTask task, long delay, long period)` schedules task for repeated fixed-delay execution, beginning after `delay` milliseconds. Subsequent executions take place at approximately regular intervals separated by `period` milliseconds. This method throws `IllegalArgumentException` when `delay` is negative, `delay + System.currentTimeMillis()` is negative, or `period` is negative or zero; `IllegalStateException` when task was already scheduled or canceled, the timer was canceled, or the task-execution thread terminated; and `NullPointerException` when task is null.
- `void scheduleAtFixedRate(TimerTask task, Date firstTime, long period)` schedules task for repeated fixed-rate execution, beginning at time. Subsequent executions take place at approximately regular intervals, separated by `period` milliseconds. In *fixed-rate execution*, each execution is scheduled relative to the scheduled execution time of the initial execution. When an execution is delayed for any reason (such as garbage collection), two or more executions will occur in rapid succession to “catch up.” In the long run, the frequency of execution



will be exactly the reciprocal of period (assuming the system clock underlying `Object.wait(long)` is accurate). As a consequence, when the scheduled `firstTime` is in the past, any “missed” executions will be scheduled for immediate “catch up” execution. Fixed-rate execution is appropriate for recurring activities that are sensitive to absolute time (such as ringing a chime every hour on the hour, or running scheduled maintenance every day at a particular time). It’s also appropriate for recurring activities where the total time to perform a fixed number of executions is important, such as a countdown timer that ticks once every second for ten seconds. Finally, fixed-rate execution is appropriate for scheduling multiple repeating timer tasks that must remain synchronized with respect to one another. This method throws `IllegalArgumentException` when `firstTime.getTime()` is negative, or `period` is negative or zero; `IllegalStateException` when `task` was already scheduled or canceled, the timer was canceled, or the task-execution thread terminated; and `NullPointerException` when `task` or `firstTime` is `null`.

- `void scheduleAtFixedRate(TimerTask task, long delay, long period)` schedules `task` for repeated fixed-rate execution, beginning after `delay` milliseconds. Subsequent executions take place at approximately regular intervals, separated by `period` milliseconds. This method throws `IllegalArgumentException` when `delay` is negative, `delay + System.currentTimeMillis()` is negative, or `period` is negative or zero; `IllegalStateException` when `task` was already scheduled or canceled, the timer was canceled, or the task-execution thread terminated; and `NullPointerException` when `task` is `null`.

After the last live reference to a `Timer` object goes away and all outstanding timer tasks have completed execution, the timer’s task-execution thread terminates gracefully (and becomes subject to garbage collection). However, this can take arbitrarily long to occur. (By default, the task-execution thread doesn’t run as a daemon thread, so it’s capable of preventing an application from terminating.) When an application wants to terminate a timer’s task-execution thread rapidly, the application should invoke `Timer`’s `cancel()` method.

When the timer’s task-execution thread terminates unexpectedly, for example, because its `stop()` method was invoked (you should never call any of `Thread`’s `stop()` methods because they’re inherently unsafe), any further attempt to schedule a timer task on the timer results in `IllegalStateException`, as if `Timer`’s `cancel()` method had been invoked.

## TimerTask in Depth

Timer tasks are instances of classes that subclass the abstract `TimerTask` class, which implements the `Runnable` interface and offers the following methods:

- `boolean cancel()` cancels this timer task. When the timer task has been scheduled for one-shot execution and hasn’t yet run or when it hasn’t yet been scheduled, it will never run. When the timer task has been scheduled for repeated execution, it will never run again. (When the timer task is running when this call occurs, the timer task will run to completion, but will never run again.) Calling `cancel()` from within the `run()` method of a repeating timer task

absolutely guarantees that the timer task won't run again. This method may be called repeatedly; the second and subsequent calls have no effect. This method returns true when this timer task is scheduled for one-shot execution and hasn't yet run or when this timer task is scheduled for repeated execution. It returns false when the timer task was scheduled for one-shot execution and has already run, when the timer task was never scheduled, or when the timer task was already canceled. (Loosely speaking, this method returns true when it prevents one or more scheduled executions from taking place.)

- `void run()` provides the timer task's code. You must override this abstract method to perform a useful activity.
- `long scheduledExecutionTime()` returns the scheduled execution time of the most recent actual execution of this timer task. (When this method is invoked while timer task execution is in progress, the return value is the scheduled execution time of the ongoing timer task execution.) This method is typically invoked from within a task's `run()` method to determine whether the current execution of the timer task is sufficiently timely to warrant performing the scheduled activity. For example, you would specify code similar to `if (System.currentTimeMillis() - scheduledExecutionTime() >= MAX_TARDINESS) return;` at the start of the `run()` method to abort the current timer task execution when it's not timely. This method is typically not used in conjunction with fixed-delay execution repeating timer tasks because their scheduled execution times are allowed to drift over time and are thus not terribly significant. `scheduledExecutionTime()` returns the time at which the most recent execution of this timer task was scheduled to occur, in the format returned by `Date.getTime()`. The return value is undefined when the timer task has yet to commence its first execution.

Timer tasks should complete quickly. When a timer task takes too long to complete, it “hogs” the timer's task-execution thread, delaying the execution of subsequent timer tasks, which may “bunch up” and execute in rapid succession if and when the offending timer task finally completes.

## One-Shot Execution and Repeated Execution with Cancellation

Listing 8-9 demonstrates a timer executing a timer task indefinitely. You can also execute a timer task exactly once or execute it repeatedly until you want to cancel the task. I've created a simple `TimerDemo` application that demonstrates `Timer` and `TimerTask` in one-shot execution and repeated execution with cancellation contexts. Check out Listing 8-10.

*Listing 8-10. Demonstrating One-Shot Execution and Repeated Execution with Cancellation*

```
import java.util.Timer;
import java.util.TimerTask;

public class TimerDemo
{
    public static void main(String[] args)
    {
        Timer t = new Timer(true);
```

```

t.schedule(new TimerTask()
    {
        @Override
        public void run()
        {
            System.out.println("one-shot timer task executing");
        }
    }, 2000); // Execute one-shot timer task after 2-second delay.
System.out.println("main thread is sleeping for 4 seconds");
try { Thread.sleep(4000); } catch (InterruptedException ie) {}
System.out.println("main thread has woken up");
t = new Timer();
t.schedule(new TimerTask()
    {
        int i; // initializes to 0 by default
        @Override
        public void run()
        {
            System.out.println("repeated timer task is running");
            if (++i == 6)
            {
                System.out.println("canceling repeated timer task");
                cancel();
                System.out.println("canceled");
                System.exit(0);
            }
        }
    }, 2000, 500);
System.out.println("main thread is terminating");
}
}

```

Listing 8-10's main thread first creates a timer whose task-execution thread is daemon, and then schedules a one-shot timer task to execute two seconds later. The main thread then sleeps for four seconds to give you an opportunity to observe the timer task's execution via an output message.

After the main thread awakens, it creates a second timer whose task-execution thread isn't daemon, and then schedules a repeating timer task to run two seconds later and repeat every half-second. The main thread then terminates.

Because the second timer's task-execution thread isn't daemon, the application doesn't terminate. Instead, the timer repeatedly executes its timer task six times before the final timer task execution cancels itself and invokes `System.exit(0)`; to terminate the application. Without `System.exit(0)`, the application would never end because the timer's nondaemon task-execution thread is still running and waiting to execute subsequently scheduled timer tasks.

Compile Listing 8-10 (`javac TimerDemo.java`) and run this application (`java TimerDemo`). You should observe the following output:

```

main thread is sleeping for 4 seconds
one-shot timer task executing
main thread has woken up

```

```
main thread is terminating
repeated timer task is running
repeated timer task is running
repeated timer task is running
repeated timer task is running
repeated timer task is running
repeated timer task is running
repeated timer task is running
canceling repeated timer task
canceled
```

## EXERCISES

The following exercises are designed to test your understanding of Chapter 8's content.

1. What does the `Random` class accomplish?
2. Define root set of references.
3. True or false: The garbage collector can collect reachable and unreachable objects.
4. Identify the different levels of reachability.
5. What is the different between a soft reference and a weak reference?
6. Identify the classes that comprise the `References` API.
7. Which reference class would you use to implement caches of objects that are expensive timewise to create?
8. Which reference class would you use as a replacement for the `finalize()` method?
9. What are some of the capabilities offered by the `Reflection` API?
10. `Reflection` should not be used indiscriminately. Why not?
11. Identify the class that is the entry point into the `Reflection` API.
12. True or false: All of the `Reflection` API is contained in the `java.lang.reflect` package?
13. What are the three ways to obtain a `Class` object?
14. True or false: You can use class literals with primitive types.
15. How do you instantiate a dynamically loaded class?
16. What method do you invoke to obtain a constructor's parameter types?
17. What does `Class`'s `Field getField(String name)` method do when it cannot locate the named field?
18. How do you determine if a method is declared to receive a variable number of arguments?
19. True or false: You can reflectively make a private method accessible.
20. What is the purpose of `Package`'s `isSealed()` method?
21. True or false: `getPackage()` requires at least one classfile to be loaded from the package before it returns a `Package` object describing that package.

22. How do you reflectively create and access a Java array?
23. What is the purpose of the `StringTokenizer` class?
24. Identify the standard class library's convenient and simpler alternative to the `Threads` API for scheduling task execution.
25. True or false: `Timer()` creates a new timer whose task-execution thread runs as a daemon thread.
26. Define fixed-delay execution.
27. Which methods do you call to schedule a task for fixed-delay execution?
28. Define fixed-rate execution.
29. What is the difference between `Timer`'s `cancel()` method and `TimerTask`'s `cancel()` method?
30. Create a `Guess` application that uses `Random` to generate a random integer from 0 to 25. Then, the application repeatedly asks the user to guess which integer was chosen by entering a letter from a through z. The application continues by comparing the entered letter with the random integer (which is offset by lowercase letter a) to learn if the user's choice was too low, too high, or just right; and outputs an appropriate message.
31. Create a `Classify` application that uses `Class`'s `forName()` method to load its single command-line argument, which will represent a package-qualified annotation type, enum, interface, or class (the default). Use a chained if-else statement along with the appropriate `Class` methods and `System.out.println()` to identify the type and output `Annotation`, `Enum`, `Interface`, or `Class`.
32. Create a `Tokenize` application that uses `StringTokenizer` to extract the month, day, year, hour, minute, and second fields from the string `03-12-2014 03:05:20`, which are then output.
33. Create a `BackAndForth` application that uses `Timer` and `TimerTask` to repeatedly move an asterisk forward 20 steps and then backward 20 steps. The asterisk is output via `System.out.print()`.

---

## Summary

The `Math` class's `random()` method is implemented in terms of the `Random` class, whose instances are known as random number generators. `Random` generates a sequence of random numbers by starting with a special 48-bit seed. This value is subsequently modified via a mathematical algorithm that is known as a linear congruential generator.

`Random` declares a pair of constructors, a `setSeed()` method for setting the random number generator's seed, and several "next"-prefixed methods that return the next number in the sequence as a `Boolean` value, an integer, a long integer, a floating-point value, or a double precision floating-point value. There is even a method for generating a sequence of random bytes.

When an application runs, its execution reveals a root set of references, which changes during the application's execution. Garbage collectors use the root set to determine if an object is reachable or unreachable. The garbage collector cannot collect reachable objects. Instead, it can only collect objects that, starting from the root set of references, cannot be reached.

Reachable objects are classified as strongly reachable, softly reachable, weakly reachable, and phantom reachable. Unlike strongly reachable objects, softly, weakly, and phantom reachable objects can be garbage collected. References to softly, weakly, and phantom reachable objects are encapsulated by `SoftReference`, `WeakReference`, and `PhantomReference` objects.

`SoftReference`, `WeakReference`, and `PhantomReference` extend the `Reference` class. When you associate a `ReferenceQueue` instance with one of these `Reference` subclass objects, the `Reference` subclass object is added to the queue when the object to which its encapsulated reference refers (this object is known as a referent) becomes garbage.

Java's Reflection API offers a third RTTI form in which applications can dynamically load and learn about loaded classes and other reference types. The API also lets applications instantiate classes, call methods, access fields, and perform other tasks reflectively. This form of RTTI is known as reflection or introspection.

The `java.lang` package's `Class` class is the entry point into the Reflection API, whose types are stored mainly in the `java.lang.reflect` package. You can obtain a `Class` object by invoking `Class.forName()` method, by invoking `Object.getClass()` method, or by using a class literal, which is the name of a class followed by a `.class` suffix.

The `java.lang.reflect` package declares `Constructor`, `Field`, and `Method` classes that represent constructors, fields, and methods. Each of these classes extends the `AccessibleObject` class, which provides methods for determining if the constructor, field, or method is accessible; and for changing the constructor's, field's, or method's accessibility.

The `Package` class provides access to package information. This information includes version information about the implementation and specification of a Java package, the package's name, and an indication of whether the package is sealed or not. Also, the `Array` class provides class methods that make it possible to reflectively create and access Java arrays.

You'll occasionally want to extract a string's individual components. The task of breaking up a string into its individual components is known as parsing or tokenizing. The components themselves are known as tokens. Java 1.0 introduced the `StringTokenizer` class to let applications tokenize strings.

`StringTokenizer` provides constructors for specifying the string to be tokenized and the set of delimiters that separate successive tokens. The number of tokens can be obtained by invoking the `countTokens()` method.

The `hasMoreElements()` and `hasMoreTokens()` methods tell you whether there are more tokens to extract. The `nextToken()` and `nextElement()` methods return the next token. One of the `nextToken()` methods also lets you specify a new set of delimiters.

It's often necessary to schedule a task for one-shot execution in which the task runs only once or for repeated execution at regular intervals. You can use the `Threads` API to accomplish task scheduling. However, Java 1.3 introduced a more convenient and simpler alternative in the form of `Timer` and `TimerTask` classes.

`Timer` provides a facility for scheduling `TimerTasks` for future execution on a background thread. `Timer` tasks may be scheduled for one-shot execution or for repeated execution at regular intervals. Corresponding to each `Timer` object is a single background thread that's used to execute all of the timer tasks sequentially.

This chapter completes my tour of Java's basic APIs. Chapter 9 explores Java's Collections Framework and classic collections APIs.

# Exploring the Collections Framework

Applications often must manage collections of objects. Although you can use arrays for this purpose, they are not always a good choice. For example, arrays have fixed sizes, making it tricky to determine an optimal size when you need to store a variable number of objects. Also, arrays can be indexed by integers only, making them unsuitable for mapping arbitrary objects to other objects.

The standard class library provides the Collections Framework and legacy utility APIs to manage collections on behalf of applications. In this chapter, I first present this framework and then introduce you to these legacy APIs (in case you encounter them in legacy code). As you will discover, some of the legacy APIs are still useful.

**Note** Java's Concurrency Utilities API suite (discussed in Chapter 10) extends the Collections Framework.

## Exploring Collections Framework Fundamentals

The *Collections Framework* is a group of types (mainly located in the `java.util` package) that offers a standard architecture for representing and manipulating *collections*, which are groups of objects stored in instances of classes designed for this purpose. This framework's architecture is divided into three sections:

- *Core interfaces*: The framework provides core interfaces for manipulating collections independently of their implementations.
- *Implementation classes*: The framework provides classes that offer different core interface implementations to address performance and other requirements.
- *Utility classes*: The framework provides utility classes with methods for sorting arrays, obtaining synchronized collections, and more.

The core interfaces include `java.lang.Iterable`, `Collection`, `List`, `Set`, `SortedSet`, `NavigableSet`, `Queue`, `Deque`, `Map`, `SortedMap`, and `NavigableMap`. `Collection` extends `Iterable`; `List`, `Set`, and `Queue` each extend `Collection`; `SortedSet` extends `Set`; `NavigableSet` extends `SortedSet`; `Deque` extends `Queue`; `SortedMap` extends `Map`; and `NavigableMap` extends `SortedMap`.

Figure 9-1 illustrates the core interfaces hierarchy (arrows point to parent interfaces).

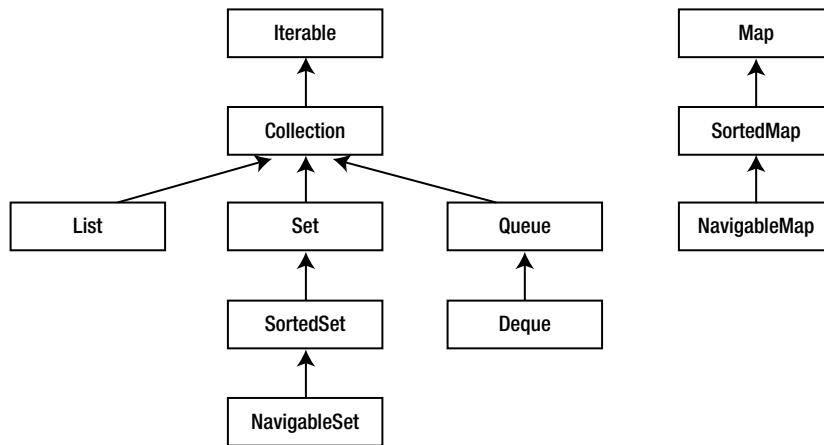

**Figure 9-1.** The Collections Framework is based on a hierarchy of core interfaces

The framework's implementation classes include `ArrayList`, `LinkedList`, `TreeSet`, `HashSet`, `LinkedHashSet`, `EnumSet`, `PriorityQueue`, `ArrayDeque`, `TreeMap`, `HashMap`, `LinkedHashMap`, `IdentityHashMap`, `WeakHashMap`, and `EnumMap`. The name of each concrete class ends in a core interface name, identifying the core interface on which it is based.

**Note** Additional implementation classes are part of the concurrency utilities.

The framework's implementation classes also include the abstract `AbstractCollection`, `AbstractList`, `AbstractSequentialList`, `AbstractSet`, `AbstractQueue`, and `AbstractMap` classes. These classes offer skeletal implementations of the core interfaces to facilitate the creation of concrete implementation classes.

Finally, the framework provides two utility classes: `Arrays` and `Collections`.

## Comparable vs. Comparator

A collection implementation stores its elements in some *order* (arrangement). This order may be unsorted, or it may be sorted according to some criterion (such as alphabetical, numerical, or chronological).

A sorted collection implementation defaults to storing its elements according to their *natural ordering*. For example, the natural ordering of `java.lang.String` objects is *lexicographic* or *dictionary* (also known as alphabetical) order.



A collection cannot rely on `equals()` to dictate natural ordering because this method can only determine if two elements are equivalent. Instead, element classes must implement the `java.lang.Comparable<T>` interface and its `int compareTo(T o)` method.

**Note** According to `Comparable`'s Oracle-based Java documentation, this interface is considered to be part of the Collections Framework even though it is a member of the `java.lang` package.

A sorted collection uses `compareTo()` to determine the natural ordering of this method's element argument `o` in a collection. `compareTo()` compares argument `o` with the current element (which is the element on which `compareTo()` was called) and does the following:

- It returns a negative value when the current element should precede `o`.
- It returns a zero value when the current element and `o` are the same.
- It returns a positive value when the current element should succeed `o`.

When you need to implement `Comparable`'s `compareTo()` method, there are some rules that you must follow. The following rules are similar to those shown in Chapter 4 for implementing the `equals()` method:

- `compareTo()` *must be reflexive*: For any nonnull reference value `x`, `x.compareTo(x)` must return 0.
- `compareTo()` *must be symmetric*: For any nonnull reference values `x` and `y`, `x.compareTo(y) == -y.compareTo(x)` must hold.
- `compareTo()` *must be transitive*: For any nonnull reference values `x`, `y`, and `z`, if `x.compareTo(y) > 0` is true, and if `y.compareTo(z) > 0` is true, then `x.compareTo(z) > 0` must also be true.

Also, `compareTo()` should throw `java.lang.NullPointerException` when the null reference is passed to this method. However, you don't need to check for null because this method throws `NullPointerException` when it attempts to access a null reference's nonexistent members.

**Note** Before Java 5 and its introduction of generics, `compareTo()`'s argument was of type `java.lang.Object` and had to be cast to the appropriate type before the comparison could be made. The cast operator would throw a `java.lang.ClassCastException` instance when the argument's type was not compatible with the cast.

You might occasionally need to store in a collection objects that are sorted in some order that differs from their natural ordering. In this case, you would supply a comparator to provide that ordering.

A *comparator* is an object whose class implements the `Comparator` interface. This interface, whose generic type is `Comparator<T>`, provides the following pair of methods:

- `int compare(T o1, T o2)` compares both arguments for order. This method returns 0 when `o1` equals `o2`, a negative value when `o1` is less than `o2`, and a positive value when `o1` is greater than `o2`.
- `boolean equals(Object o)` returns true when `o` “equals” this `Comparator` in that `o` is also a `Comparator` and imposes the same ordering. Otherwise, this method returns false.

**Note** `Comparator` declares `equals()` because this interface places an extra condition on this method’s contract. *Additionally, this method can return true only if the specified object is also a comparator and it imposes the same ordering as this comparator. You don’t have to override `equals()`, but doing so may improve performance by allowing programs to determine that two distinct comparators impose the same order.*

Chapter 6 provided an example that illustrated implementing `Comparable`, and you will discover another example later in this chapter. Also, in this chapter, I will present examples of implementing `Comparator`.

## Iterable and Collection

Most of the core interfaces are rooted in `Iterable` and its `Collection` subinterface. Their generic types are `Iterable<T>` and `Collection<E>`.

`Iterable` describes any object that can return its contained objects in some sequence. This interface declares an `Iterator<T> iterator()` method that returns an `Iterator` instance for iterating over all of the contained objects.

`Collection` represents a collection of objects that are known as *elements*. This interface provides methods that are common to the `Collection` subinterfaces on which many collections are based. Table 9-1 describes these methods.

**Table 9-1. Collection Methods**

Method	Description
boolean add(E e)	<p>Adds element <i>e</i> to this collection. Returns true if this collection was modified as a result; otherwise, returns false. (Attempting to add <i>e</i> to a collection that doesn't permit duplicates and already contains a same-valued element results in <i>e</i> not being added.) This method throws <code>java.lang.UnsupportedOperationException</code> when <code>add()</code> is not supported, <code>ClassCastException</code> when <i>e</i>'s class is not appropriate for this collection, <code>java.lang.IllegalArgumentException</code> when some property of <i>e</i> prevents it from being added to this collection, <code>NullPointerException</code> when <i>e</i> contains the null reference and this collection doesn't support null elements, and <code>java.lang.IllegalStateException</code> when the element cannot be added at this time because of insertion restrictions.</p> <p><code>IllegalStateException</code> signals that a method has been invoked at an illegal or inappropriate time. In other words, the Java/Android environment or application is not in an appropriate state for the requested operation. It is often thrown when you try to add an element to a <i>bounded queue</i> (a queue with a maximum length) and the queue is full.</p>
boolean addAll(Collection<? extends E> c)	<p>Adds all elements of collection <i>c</i> to this collection. Returns true if this collection was modified as a result; otherwise, returns false. This method throws <code>UnsupportedOperationException</code> when this collection doesn't support <code>addAll()</code>, <code>ClassCastException</code> when the class of one of <i>c</i>'s elements is inappropriate for this collection, <code>IllegalArgumentException</code> when some property of an element prevents it from being added to this collection, <code>NullPointerException</code> when <i>c</i> contains the null reference or when one of its elements is null and this collection doesn't support null elements, and <code>IllegalStateException</code> when not all the elements can be added at this time because of insertion restrictions.</p>
void clear()	<p>Removes all elements from this collection. This method throws <code>UnsupportedOperationException</code> when this collection doesn't support <code>clear()</code>.</p>
boolean contains(Object o)	<p>Returns true when this collection contains <i>o</i>; otherwise, returns false. This method throws <code>ClassCastException</code> when the class of <i>o</i> is inappropriate for this collection and <code>NullPointerException</code> when <i>o</i> contains the null reference and this collection doesn't support null elements.</p>
boolean containsAll(Collection<?> c)	<p>Returns true when this collection contains all of the elements that are contained in the collection specified by <i>c</i>; otherwise, returns false. This method throws <code>ClassCastException</code> when the class of one of <i>c</i>'s elements is inappropriate for this collection and <code>NullPointerException</code> when <i>c</i> contains the null reference or when one of its elements is null and this collection doesn't support null elements.</p>

(continued)

Table 9-1. (continued)

Method	Description
<code>boolean equals(Object o)</code>	Compares <code>o</code> with this collection and returns true when <code>o</code> equals this collection; otherwise, returns false.
<code>int hashCode()</code>	Returns this collection's hash code. Equal collections have equal hash codes.
<code>boolean isEmpty()</code>	Returns true when this collection contains no elements; otherwise, returns false.
<code>Iterator&lt;E&gt; iterator()</code>	Returns an <code>Iterator</code> instance for iterating over all of the elements contained in this collection. There are no guarantees concerning the order in which the elements are returned (unless this collection is an instance of some class that provides a guarantee). This <code>Iterable</code> method is redeclared in <code>Collection</code> for convenience.
<code>boolean remove(Object o)</code>	Removes the element identified as <code>o</code> from this collection. Returns true when the element is removed; otherwise, returns false. This method throws <code>UnsupportedOperationException</code> when this collection doesn't support <code>remove()</code> , <code>ClassCastException</code> when the class of <code>o</code> is inappropriate for this collection, and <code>NullPointerException</code> when <code>o</code> contains the null reference and this collection doesn't support null elements.
<code>boolean removeAll(Collection&lt;?&gt; c)</code>	Removes all of the elements from this collection that are also contained in collection <code>c</code> . Returns true when this collection is modified by this operation; otherwise, returns false. This method throws <code>UnsupportedOperationException</code> when this collection doesn't support <code>removeAll()</code> , <code>ClassCastException</code> when the class of one of <code>c</code> 's elements is inappropriate for this collection, and <code>NullPointerException</code> when <code>c</code> contains the null reference or when one of its elements is null and this collection doesn't support null elements.
<code>boolean retainAll(Collection&lt;?&gt; c)</code>	Retains all of the elements in this collection that are also contained in collection <code>c</code> . Returns true when this collection is modified by this operation; otherwise, returns false. This method throws <code>UnsupportedOperationException</code> when this collection doesn't support <code>retainAll()</code> , <code>ClassCastException</code> when the class of one of <code>c</code> 's elements is inappropriate for this collection, and <code>NullPointerException</code> when <code>c</code> contains the null reference or when one of its elements is null and this collection doesn't support null elements.
<code>int size()</code>	Returns the number of elements contained in this collection, or <code>java.lang.Integer.MAX_VALUE</code> when there are more than <code>Integer.MAX_VALUE</code> elements contained in the collection.

(continued)

Table 9-1. (continued)

Method	Description
<code>Object[] toArray()</code>	<p>Returns an array containing all of the elements stored in this collection. If this collection makes any guarantees as to what order its elements are returned in by its iterator, this method returns the elements in the same order.</p> <p>The returned array is “safe” in that no references to it are maintained by this collection. (In other words, this method allocates a new array even when this collection is backed by an array.) The caller can safely modify the returned array.</p>
<code>&lt;T&gt; T[] toArray(T[] a)</code>	<p>Returns an array containing all of the elements in this collection; the runtime type of the returned array is that of the specified array. If the collection fits in the specified array, it’s returned in the array. Otherwise, a new array is allocated with the runtime type of the specified array and the size of this collection. This method throws <code>NullPointerException</code> when <code>null</code> is passed to <code>a</code>, and <code>java.lang.ArrayStoreException</code> when <code>a</code>’s runtime type is not a supertype of the runtime type of every element in this collection.</p>

Table 9-1 reveals three exceptional things about various `Collection` methods. First, some methods can throw instances of the `UnsupportedOperationException` class. For example, `add()` throws `UnsupportedOperationException` when you attempt to add an object to an *immutable* (unmodifiable) collection (discussed later in this chapter).

Second, some of `Collection`’s methods can throw instances of the `ClassCastException` class. For example, `remove()` throws `ClassCastException` when you attempt to remove an entry (also known as mapping) from a tree-based map whose keys are `Strings`, but specify a non-`String` key instead.

Finally, `Collection`’s `add()` and `addAll()` methods throw `IllegalArgumentException` instances when some *property* (attribute) of the element to be added prevents it from being added to this collection. For example, a third-party collection class’s `add()` and `addAll()` methods might throw this exception when they detect negative `Integer` values.

**Note** Perhaps you’re wondering why `remove()` is declared to accept any `Object` argument instead of accepting only objects whose types are those of the collection. In other words, why is `remove()` not declared as `boolean remove(E e)`? Also, why are `containsAll()`, `removeAll()`, and `retainAll()` not declared with an argument of type `Collection<? extends E>` to ensure that the collection argument only contains elements of the same type as the collection on which these methods are called? The answer to these questions is the need to maintain backward compatibility. The Collections Framework was introduced before Java 5 and its introduction of generics. To let legacy code written before version 5 continue to compile, these four methods were declared with weaker type constraints.

## Iterator and the Enhanced For Loop Statement

By extending `Iterable`, `Collection` inherits that interface's `iterator()` method, which makes it possible to iterate over a collection. `iterator()` returns an instance of a class that implements the `Iterator` interface, whose generic type is expressed as `Iterator<E>` and which declares the following three methods:

- `boolean hasNext()` returns `true` when this `Iterator` instance has more elements to return; otherwise, this method returns `false`.
- `E next()` returns the next element from the collection associated with this `Iterator` instance, or throws `NoSuchElementException` when there are no more elements to return.
- `void remove()` removes the last element returned by `next()` from the collection associated with this `Iterator` instance. This method can be called only once per `next()` call. The behavior of an `Iterator` instance is unspecified when the underlying collection is modified while iteration is in progress in any way other than by calling `remove()`. This method throws `UnsupportedOperationException` when it is not supported by this `Iterator`, and `IllegalStateException` when `remove()` has been called without a previous call to `next()` or when multiple `remove()` calls occur with no intervening `next()` calls.

The following example shows you how to iterate over a collection after calling `iterator()` to return an `Iterator` instance:

```
Collection<String> col = ... // This code doesn't compile because of the ...
// Add elements to col.
Iterator iter = col.iterator();
while (iter.hasNext())
    System.out.println(iter.next());
```

The `while` loop repeatedly calls the iterator's `hasNext()` method to determine whether or not iteration should continue, and (if it should continue) the `next()` method to return the next element from the associated collection.

Because this idiom is commonly used, Java 5 introduced syntactic sugar to the `for` loop statement to simplify iteration in terms of the idiom. This sugar makes this statement appear like the `foreach` statement found in languages such as Perl and is revealed in the following simplified equivalent of the previous example:

```
Collection<String> col = ... // This code doesn't compile because of the ...
// Add elements to col.
for (String s: col)
    System.out.println(s);
```

This sugar hides `col.iterator()`, a method call that returns an `Iterator` instance for iterating over `col`'s elements. It also hides calls to `Iterator`'s `hasNext()` and `next()` methods on this instance. You interpret this sugar to read as follows: “for each `String` object in `col`, assign this object to `s` at the start of the loop iteration.”

**Note** The enhanced for loop statement is also useful in an arrays context, in which it hides the array index variable. Consider the following example:

```
String[] verbs = { "run", "walk", "jump" };
for (String verb: verbs)
    System.out.println(verb);
```

This example, which reads as “for each `String` object in the `verbs` array, assign that object to `verb` at the start of the loop iteration,” is equivalent to the following example:

```
String[] verbs = { "run", "walk", "jump" };
for (int i = 0; i < verbs.length; i++)
    System.out.println(verbs[i]);
```

The enhanced for loop statement is limited in that you cannot use this statement where access to the iterator is required to remove an element from a collection. Also, it’s not usable where you must replace elements in a collection/array during a traversal, and it cannot be used where you must iterate over multiple collections or arrays in parallel.

## Autoboxing and Unboxing

Developers who believe that Java should support only reference types have complained about Java’s support for primitive types. One area where the dichotomy of Java’s type system is clearly seen is the Collections Framework: you can store objects but not primitive-type-based values in collections.

Although you cannot directly store a primitive-type-based value in a collection, you can indirectly store this value by first wrapping it in an object created from a primitive type wrapper class such as `Integer` and then storing this primitive type wrapper class instance in the collection—see the following example:

```
Collection<Integer> col = ...; // This code doesn't compile because of the ...
int x = 27;
col.add(new Integer(x));      // Indirectly store int value 27 via an Integer object.
```

The reverse situation is also tedious. When you want to retrieve the `int` from `col`, you must invoke `Integer`’s `intValue()` method (which, if you recall, is inherited from `Integer`’s `java.lang.Number` superclass). Continuing on from this example, you would specify `int y = col.iterator().next().intValue();` to assign the stored 32-bit integer to `y`.

To alleviate this tedium, Java 5 introduced autoboxing and unboxing, a pair of complementary syntactic sugar-based language features that make primitive-type values appear more like objects. (This “sleight of hand” isn’t complete because you cannot specify expressions such as `27.doubleValue()`.)

*Autoboxing* automatically *boxes* (wraps) a primitive-type value in an object of the appropriate primitive type wrapper class whenever a primitive-type value is specified but a reference is required. For example, you could change the example's third line to `col.add(x)`; and have the compiler box `x` into an `Integer` object.

*Unboxing* automatically *unboxes* (unwraps) a primitive-type value from its wrapper object whenever a reference is specified but a primitive-type value is required. For example, you could specify `int y = col.iterator().next()`; and have the compiler unbox the returned `Integer` object to `int` value 27 prior to the assignment.

Although autoboxing and unboxing were introduced to simplify working with primitive-type values in a collections context, these language features can be used in other contexts; and this arbitrary use can lead to a problem that is difficult to understand without knowledge of what is happening behind the scenes. Consider the following example:

```
Integer i1 = 127;
Integer i2 = 127;
System.out.println(i1 == i2); // Output: true
System.out.println(i1 < i2); // Output: false
System.out.println(i1 > i2); // Output: false
System.out.println(i1 + i2); // Output: 254
i1 = 30000;
i2 = 30000;
System.out.println(i1 == i2); // Output: false
System.out.println(i1 < i2); // Output: false
System.out.println(i1 > i2); // Output: false
i2 = 30001;
System.out.println(i1 < i2); // Output: true
System.out.println(i1 + i2); // Output: 60001
```

With one exception, this example's output is as expected. The exception is the `i1 == i2` comparison where each of `i1` and `i2` contains 30000. Instead of returning `true`, as is the case where each of `i1` and `i2` contains 127, `i1 == i2` returns `false`. What is causing this problem?

Examine the generated code and you will discover that `Integer i1 = 127;` is converted to `Integer i1 = Integer.valueOf(127);` and `Integer i2 = 127;` is converted to `Integer i2 = Integer.valueOf(127);`. According to `valueOf()`'s Java documentation, this method takes advantage of caching to improve performance.

**Note** `valueOf()` is also used when adding a primitive-type value to a collection. For example, `col.add(27)` is converted to `col.add(Integer.valueOf(27))`.

`Integer` maintains an internal cache of unique `Integer` objects over a small range of values. The low bound of this range is -128, and the high bound defaults to 127. However, you can change the high bound by assigning a different value to system property `java.lang.Integer.IntegerCache.high` (via the `java.lang.System` class's `String setProperty(String name, String value)` method—I demonstrated this method's `String getProperty(String name)` counterpart in Chapter 7).



**Note** Each of `java.lang.Byte`, `java.lang.Long`, and `java.lang.Short` also maintains an internal cache of unique `Byte`, `Long`, and `Short` objects, respectively.

Because of the cache, each `Integer.valueOf(127)` call returns the same `Integer` object reference, which is why `i1 == i2` (which compares references) evaluates to `true`. Because 30000 lies outside of the default range, each `Integer.valueOf(30000)` call returns a reference to a new `Integer` object, which is why `i1 == i2` evaluates to `false`.

In contrast to `==` and `!=`, which don't unbox the boxed values prior to the comparison, operators such as `<`, `>`, and `+` unbox these values before performing their operations. As a result, `i1 < i2` is converted to `i1.intValue() < i2.intValue()` and `i1 + i2` is converted to `i1.intValue() + i2.intValue()`.

**Caution** Don't assume that autoboxing and unboxing are used in the context of the `==` and `!=` operators.

## Exploring Lists

A *list* is an ordered collection, which is also known as a *sequence*. Elements can be stored in and accessed from specific locations via integer indexes. Some of these elements may be duplicates or null (when the list's implementation allows null elements). Lists are described by the `List` interface, whose generic type is `List<E>`.

`List` extends `Collection` and redeclares its inherited methods, partly for convenience. It also redeclares `iterator()`, `add()`, `remove()`, `equals()`, and `hashCode()` to place extra conditions on their contracts. For example, `List`'s contract for `add()` specifies that it appends an element to the end of the list rather than adding the element to the collection.

`List` also declares Table 9-2's list-specific methods.

**Table 9-2.** List-Specific Methods

Method	Description
<code>void add(int index, E e)</code>	Inserts element <code>e</code> into this list at position <code>index</code> . Shifts the element currently at this position (if any) and any subsequent elements to the right. This method throws <code>UnsupportedOperationException</code> when this list doesn't support <code>add()</code> , <code>ClassCastException</code> when <code>e</code> 's class is inappropriate for this list, <code>IllegalArgumentException</code> when some property of <code>e</code> prevents it from being added to this list, <code>NullPointerException</code> when <code>e</code> contains the null reference and this list doesn't support null elements, and <code>java.lang.IndexOutOfBoundsException</code> when <code>index</code> is less than 0 or <code>index</code> is greater than <code>size()</code> .
<code>boolean addAll(int index, Collection&lt;? extends E&gt; c)</code>	Inserts all of <code>c</code> 's elements into this list starting at position <code>index</code> and in the order that they are returned by <code>c</code> 's iterator. Shifts the element currently at this position (if any) and any subsequent elements to the right. This method throws <code>UnsupportedOperationException</code> when this list doesn't support <code>addAll()</code> , <code>ClassCastException</code> when the class of one of <code>c</code> 's elements is inappropriate for this list, <code>IllegalArgumentException</code> when some property of an element prevents it from being added to this list, <code>NullPointerException</code> when <code>c</code> contains the null reference or when one of its elements is null and this list doesn't support null elements, and <code>IndexOutOfBoundsException</code> when <code>index</code> is less than 0 or <code>index</code> is greater than <code>size()</code> .
<code>E get(int index)</code>	Returns the element stored in this list at position <code>index</code> . This method throws <code>IndexOutOfBoundsException</code> when <code>index</code> is less than 0 or <code>index</code> is greater than or equal to <code>size()</code> .
<code>int indexOf(Object o)</code>	Returns the index of the first occurrence of element <code>o</code> in this list, or -1 when this list doesn't contain the element. This method throws <code>ClassCastException</code> when <code>o</code> 's class is inappropriate for this list and <code>NullPointerException</code> when <code>o</code> contains the null reference and this list doesn't support null elements.
<code>int lastIndexOf(Object o)</code>	Returns the index of the last occurrence of element <code>o</code> in this list, or -1 when this list doesn't contain the element. This method throws <code>ClassCastException</code> when <code>o</code> 's class is inappropriate for this list and <code>NullPointerException</code> when <code>o</code> contains the null reference and this list doesn't support null elements.
<code>ListIterator&lt;E&gt; listIterator()</code>	Returns a list iterator over the elements in this list. The elements are returned in the same order as they appear in the list.
<code>ListIterator&lt;E&gt; listIterator(int index)</code>	Returns a list iterator over the elements in this list starting with the element located at <code>index</code> . The elements are returned in the same order as they appear in the list. This method throws <code>IndexOutOfBoundsException</code> when <code>index</code> is less than 0 or <code>index</code> is greater than <code>size()</code> .

*(continued)*

Table 9-2. (continued)

Method	Description
<code>E remove(int index)</code>	Removes the element at position <code>index</code> from this list, shifts any subsequent elements to the left, and returns this element. This method throws <code>UnsupportedOperationException</code> when this list doesn't support <code>remove()</code> and <code>IndexOutOfBoundsException</code> when <code>index</code> is less than 0 or <code>index</code> is greater than or equal to <code>size()</code> .
<code>E set(int index, E e)</code>	Replaces the element at position <code>index</code> in this list with element <code>e</code> and returns the element previously stored at this position. This method throws <code>UnsupportedOperationException</code> when this list doesn't support <code>set()</code> , <code>ClassCastException</code> when <code>e</code> 's class is inappropriate for this list, <code>IllegalArgumentException</code> when some property of <code>e</code> prevents it from being added to this list, <code>NullPointerException</code> when <code>e</code> contains the null reference and this list doesn't support null elements, and <code>IndexOutOfBoundsException</code> when <code>index</code> is less than 0 or <code>index</code> is greater than or equal to <code>size()</code> .
<code>List&lt;E&gt; subList(int fromIndex, int toIndex)</code>	Returns a view (discussed later) of the portion of this list between <code>fromIndex</code> (inclusive) and <code>toIndex</code> (exclusive). (If <code>fromIndex</code> and <code>toIndex</code> are equal, the returned list is empty.) The returned list is backed by this list, so nonstructural changes in the returned list are reflected in this list and vice versa. The returned list supports all of the optional list methods (those methods that can throw <code>UnsupportedOperationException</code> ) supported by this list. This method throws <code>IndexOutOfBoundsException</code> when <code>fromIndex</code> is less than 0, <code>toIndex</code> is greater than <code>size()</code> , or <code>fromIndex</code> is greater than <code>toIndex</code> .

Table 9-2 refers to the `ListIterator` interface, which is more flexible than its `Iterator` superinterface in that `ListIterator` provides methods for iterating over a list in either direction, modifying the list during iteration, and obtaining the iterator's current position in the list.

**Note** The `Iterator` and `ListIterator` instances that are returned by the `iterator()` and `listIterator()` methods in the `ArrayList` and `LinkedList` `List` implementation classes are *fail-fast*: when a list is structurally modified (by calling the implementation's `add()` method to add a new element, for example) after the iterator is created, in any way except through the iterator's own `add()` and `remove()` methods, the iterator throws `ConcurrentModificationException`. Therefore, in the face of concurrent modification, the iterator fails quickly and cleanly, rather than risking arbitrary, nondeterministic behavior at an undetermined time in the future.

ListIterator declares the following methods:

- `void add(E e)` inserts `e` into the list being iterated over. This element is inserted immediately before the next element that would be returned by `next()`, if any, and after the next element that would be returned by `previous()`, if any. This method throws `UnsupportedOperationException` when this list iterator doesn't support `add()`, `ClassCastException` when `e`'s class is inappropriate for the list, and `IllegalArgumentException` when some property of `e` prevents it from being added to the list.
- `boolean hasNext()` returns true when this list iterator has more elements when traversing the list in the forward direction.
- `boolean hasPrevious()` returns true when this list iterator has more elements when traversing the list in the reverse direction.
- `E next()` returns the next element in the list and advances the cursor position. This method throws `NoSuchElementException` when there is no next element.
- `int nextIndex()` returns the index of the element that would be returned by a subsequent call to `next()`, or the size of the list when at the end of the list.
- `E previous()` returns the previous element in the list and moves the cursor position backward. This method throws `NoSuchElementException` when there is no previous element.
- `int previousIndex()` returns the index of the element that would be returned by a subsequent call to `previous()` or -1 when at the beginning of the list.
- `void remove()` removes from the list the last element that was returned by `next()` or `previous()`. This call can be made only once per call to `next()` or `previous()`. Furthermore, it can be made only when `add()` has not been called after the last call to `next()` or `previous()`. This method throws `UnsupportedOperationException` when this list iterator doesn't support `remove()` and `IllegalStateException` when neither `next()` nor `previous()` has been called or `remove()` or `add()` has already been called after the last call to `next()` or `previous()`.
- `void set(E e)` replaces the last element returned by `next()` or `previous()` with element `e`. This call can be made only when neither `remove()` nor `add()` has been called after the last call to `next()` or `previous()`. This method throws `UnsupportedOperationException` when this list iterator doesn't support `set()`, `ClassCastException` when `e`'s class is inappropriate for the list, `IllegalArgumentException` when some property of `e` prevents it from being added to the list, and `IllegalStateException` when neither `next()` nor `previous()` has been called or `remove()` or `add()` has already been called after the last call to `next()` or `previous()`.

A `ListIterator` instance doesn't have the concept of a current element. Instead, it has the concept of a *cursor* for navigating through a list. The `nextIndex()` and `previousIndex()` methods return the *cursor position*, which always lies between the element that would be returned by a call to

`previous()` and the element that would be returned by a call to `next()`. A list iterator for a list of length  $n$  has  $n+1$  possible cursor positions as illustrated by each caret (^) in the following:

```

                Element(0)  Element(1)  Element(2)  ... Element(n-1)
cursor positions:  ^          ^          ^          ^          ^

```

**Note** You can mix calls to `next()` and `previous()` as long as you are careful. Keep in mind that the first call to `previous()` returns the same element as the last call to `next()`. Furthermore, the first call to `next()` following a sequence of calls to `previous()` returns the same element as the last call to `previous()`.

Table 9-2's description of the `subList()` method refers to the concept of a *view*, which is a list that is backed by another list. Changes that are made to the view are reflected in this backing list. The view can cover the entire list or, as `subList()`'s name implies, only part of the list.

The `subList()` method is useful for performing *range-view* operations over a list in a compact manner. For example, `list.subList(fromIndex, toIndex).clear();` removes a range of elements from `list` where the first element is at `fromIndex` and the last element is at `toIndex - 1`.

**Caution** A view's meaning becomes undefined when changes are made to the backing list. Therefore, you should only use `subList()` temporarily whenever you need to perform a sequence of range operations on the backing list.

## ArrayList

The `ArrayList` class provides a list implementation that is based on an internal array. As a result, access to the list's elements is fast. However, because elements must be moved to open a space for insertion or to close a space after deletion, insertions and deletions of elements is slow.

`ArrayList` supplies three constructors:

- `ArrayList()` creates an empty array list with an initial *capacity* (storage space) of 10 elements. Once this capacity is reached, a larger array is allocated, elements from the current array are copied into the larger array, and the larger array becomes the new current array. This process repeats as additional elements are added to the array list.
- `ArrayList(Collection<? extends E> c)` creates an array list containing `c`'s elements in the order in which they are returned by `c`'s iterator. `NullPointerException` is thrown when `c` contains the null reference.
- `ArrayList(int initialCapacity)` creates an empty array list with an initial capacity of `initialCapacity` elements. `IllegalArgumentException` is thrown when `initialCapacity` is negative.

Listing 9-1 demonstrates an array list.

*Listing 9-1. A Demonstration of an Array-Based List*

```
import java.util.ArrayList;
import java.util.List;

public class ArrayListDemo
{
    public static void main(String[] args)
    {
        List<String> ls = new ArrayList<String>();
        String[] weekDays = {"Sun", "Mon", "Tue", "Wed", "Thu", "Fri", "Sat"};
        for (String weekDay: weekDays)
            ls.add(weekDay);
        dump("ls:", ls);
        ls.set(ls.indexOf("Wed"), "Wednesday");
        dump("ls:", ls);
        ls.remove(ls.lastIndexOf("Fri"));
        dump("ls:", ls);
    }

    static void dump(String title, List<String> ls)
    {
        System.out.print(title + " ");
        for (String s: ls)
            System.out.print(s + " ");
        System.out.println();
    }
}
```

ArrayListDemo creates an array list and an array of short weekday names. It then populates this list with these names, dumps the list to standard output, changes one of the list entries, dumps the list again, removes a list entry, and dumps the list one last time. The dump() method's enhanced for loop statement uses iterator(), hasNext(), and next() behind the scenes.

When you run this application, it generates the following output:

```
ls: Sun Mon Tue Wed Thu Fri Sat
ls: Sun Mon Tue Wednesday Thu Fri Sat
ls: Sun Mon Tue Wednesday Thu Sat
```

## LinkedList

The LinkedList class provides a list implementation that is based on linked nodes. Because links must be traversed, access to the list's elements is slow. However, because only node references need to be changed, insertions and deletions of elements are fast.

## WHAT IS A NODE?

A *node* is a fixed sequence of value and link memory locations. Unlike an array, where each slot stores a single value of the same primitive type or reference supertype, a node can store multiple values of different types. It can also store *links* (references to other nodes).

Consider the following simple Node class:

```
class Node
{
    String name; // value field
    Node next;  // link field
}
```

Node describes simple nodes where each node consists of a single name value field and a single next link field. Notice that `next` is of the same type as the class in which it is declared. This arrangement lets a node instance store a reference to another node instance (which is the next node) in this field. The resulting nodes are linked together.

The following code fragment creates two Node objects and links the second Node object to the first Node object. This fragment also demonstrates how to traverse this linked list by following each Node object's `next` field. Node traversal stops when the traversal code discovers that `next` contains the null reference, which signifies the end of the list:

```
Node first = new Node();
first.name = "First node"; // You would normally provide getter and setter methods.
Node last = new Node();
last.name = "Last node";
last.next = null;
first.next = last;
Node temp = first;
while (temp != null)
{
    System.out.println(temp.name);
    temp = temp.next;
}
```

The code first builds a linked list of two Nodes and then assigns `first` to local variable `temp` in order to traverse the list without losing the reference to the first node that is stored in `first`. While `temp` is not null, the loop outputs the name field. It also navigates to the next Node object in the list via the `temp = temp.next;` statement.

If you convert this code into an application and run the application, you will discover the following output:

```
First node
Last node
```

LinkedList supplies two constructors:

- `LinkedList()` creates an empty linked list.
- `LinkedList(Collection<? extends E> c)` creates a linked list containing `c`'s elements in the order in which they are returned by `c`'s iterator. `NullPointerException` is thrown when `c` contains the null reference.

Listing 9-2 demonstrates a linked list.

*Listing 9-2. A Demonstration of a List of Linked Nodes*

```
import java.util.LinkedList;
import java.util.List;
import java.util.ListIterator;

public class LinkedListDemo
{
    public static void main(String[] args)
    {
        List<String> ls = new LinkedList<String>();
        String[] weekDays = {"Sun", "Mon", "Tue", "Wed", "Thu", "Fri", "Sat"};
        for (String weekDay: weekDays)
            ls.add(weekDay);
        dump("ls:", ls);
        ls.add(1, "Sunday");
        ls.add(3, "Monday");
        ls.add(5, "Tuesday");
        ls.add(7, "Wednesday");
        ls.add(9, "Thursday");
        ls.add(11, "Friday");
        ls.add(13, "Saturday");
        dump("ls:", ls);
        ListIterator<String> li = ls.listIterator(ls.size());
        while (li.hasPrevious())
            System.out.print(li.previous() + " ");
        System.out.println();
    }

    static void dump(String title, List<String> ls)
    {
        System.out.print(title + " ");
        for (String s: ls)
            System.out.print(s + " ");
        System.out.println();
    }
}
```

`LinkedListDemo` creates a linked list and an array of short weekday names. It then populates this list with these names, dumps the list to standard output, inserts longer weekday names after their shorter name counterparts, dumps the list again, and outputs the list in reverse order by using a list iterator with its cursor initialized past the list's end and repeatedly calling its `previous()` method.



When you run this application, it generates the following output:

```
Is: Sun Mon Tue Wed Thu Fri Sat
```

```
Is: Sun Sunday Mon Monday Tue Tuesday Wed Wednesday Thu Thursday Fri Friday Sat Saturday
Saturday Sat Friday Fri Thursday Thu Wednesday Wed Tuesday Tue Monday Mon Sunday Sun
```

## Exploring Sets

A *set* is a collection that contains no duplicate elements. In other words, a set contains no pair of elements *e1* and *e2* such that *e1.equals(e2)* returns true. Furthermore, a set can contain at most one null element. Sets are described by the Set interface, whose generic type is Set<E>.

Set extends Collection and redeclares its inherited methods, for convenience and also to add stipulations to the contracts for add(), equals(), and hashCode() to address how they behave in a set context. Also, Set's documentation states that all constructors of implementation classes must create sets that contain no duplicate elements.

Set doesn't introduce new methods.

## TreeSet

The TreeSet class provides a set implementation that is based on a tree data structure. As a result, elements are stored in sorted order. However, accessing these elements is somewhat slower than with the other Set implementations (which are not sorted) because links must be traversed.

**Note** Check out Wikipedia's "Tree (data structure)" entry ([http://en.wikipedia.org/wiki/Tree\\_\(data\\_structure\)](http://en.wikipedia.org/wiki/Tree_(data_structure))) to learn about trees.

TreeSet supplies four constructors:

- TreeSet() creates a new, empty tree set that is sorted according to the natural ordering of its elements. All elements inserted into the set must implement the Comparable interface.
- TreeSet(Collection<? extends E> c) creates a new tree set containing c's elements, sorted according to the natural ordering of its elements. All elements inserted into the new set must implement the Comparable interface. This constructor throws ClassCastException when c's elements don't implement Comparable or are not mutually comparable and NullPointerException when c contains the null reference.
- TreeSet(Comparator<? super E> comparator) creates a new, empty tree set that is sorted according to the specified comparator. Passing null to comparator implies that natural ordering will be used.
- TreeSet(SortedSet<E> ss) creates a new tree set containing the same elements and using the same ordering as ss. (I discuss sorted sets later in this chapter.) This constructor throws NullPointerException when ss contains the null reference.

Listing 9-3 demonstrates a tree set.

*Listing 9-3. A Demonstration of a Tree Set with String Elements Sorted According to Their Natural Ordering*

```
import java.util.Set;
import java.util.TreeSet;

public class TreeSetDemo
{
    public static void main(String[] args)
    {
        Set<String> ss = new TreeSet<String>();
        String[] fruits = {"apples", "pears", "grapes", "bananas", "kiwis"};
        for (String fruit: fruits)
            ss.add(fruit);
        dump("ss:", ss);
    }

    static void dump(String title, Set<String> ss)
    {
        System.out.print(title + " ");
        for (String s: ss)
            System.out.print(s + " ");
        System.out.println();
    }
}
```

TreeSetDemo creates a tree set and an array of fruit names. It then populates this set with these names and dumps the set to standard output. Because `String` implements `Comparable`, it's legal for this application to insert the contents of the `fruits` array into a tree set that was created via the `TreeSet()` constructor.

When you run this application, it generates the following output:

```
ss: apples bananas grapes kiwis pears
```

## HashSet

The `HashSet` class provides a set implementation that is backed by a hashtable data structure (implemented as a `HashMap` instance, discussed later, which provides a quick way to determine if an element has already been stored in this structure). Although this class provides no ordering guarantees for its elements, `HashSet` is much faster than `TreeSet`. Furthermore, `HashSet` permits the null reference to be stored in its instances.

**Note** Check out Wikipedia's "Hash table" entry ([http://en.wikipedia.org/wiki/Hash\\_table](http://en.wikipedia.org/wiki/Hash_table)) to learn about hashtables.

HashSet supplies four constructors:

- `HashSet()` creates a new, empty hashset where the backing `HashMap` instance has an initial capacity of 16 and a load factor of 0.75. You will learn what these items mean when I discuss `HashMap` later in this chapter.
- `HashSet(Collection<? extends E> c)` creates a new hashset containing `c`'s elements. The backing `HashMap` has an initial capacity sufficient to contain `c`'s elements and a load factor of 0.75. This constructor throws `NullPointerException` when `c` contains the null reference.
- `HashSet(int initialCapacity)` creates a new, empty hashset where the backing `HashMap` instance has the capacity specified by `initialCapacity` and a load factor of 0.75. This constructor throws `IllegalArgumentException` when `initialCapacity`'s value is less than 0.
- `HashSet(int initialCapacity, float loadFactor)` creates a new, empty hashset where the backing `HashMap` instance has the capacity specified by `initialCapacity` and the load factor specified by `loadFactor`. This constructor throws `IllegalArgumentException` when `initialCapacity` is less than 0 or when `loadFactor` is less than or equal to 0.

Listing 9-4 demonstrates a hashset.

*Listing 9-4. A Demonstration of a Hashset with String Elements Unordered*

```
import java.util.HashSet;
import java.util.Set;

public class HashSetDemo
{
    public static void main(String[] args)
    {
        Set<String> ss = new HashSet<String>();
        String[] fruits = {"apples", "pears", "grapes", "bananas", "kiwis",
                          "pears", null};
        for (String fruit: fruits)
            ss.add(fruit);
        dump("ss:", ss);
    }

    static void dump(String title, Set<String> ss)
    {
        System.out.print(title + " ");
        for (String s: ss)
            System.out.print(s + " ");
        System.out.println();
    }
}
```

`HashSetDemo` creates a hashset and an array of fruit names. It then populates this set with these names and dumps the set to standard output. Unlike with `TreeSet`, `HashSet` permits `null` to be added (`NullPointerException` isn't thrown), which is why Listing 9-4 includes `null` in `HashSetDemo`'s `fruits` array.

When you run this application, it generates unordered output such as the following:

```
ss: null grapes bananas kiwis pears apples
```

Suppose you want to add instances of your classes to a `HashSet`. As with `String`, your classes must override `equals()` and `hashCode()`; otherwise, duplicate class instances can be stored in the `HashSet`. For example, Listing 9-5 presents the source code to an application whose `Planet` class overrides `equals()` but fails to also override `hashCode()`.

*Listing 9-5. A Custom Planet Class Not Overriding hashCode()*

```
import java.util.HashSet;
import java.util.Set;

public class CustomClassAndHashSet
{
    public static void main(String[] args)
    {
        Set<Planet> sp = new HashSet<Planet>();
        sp.add(new Planet("Mercury"));
        sp.add(new Planet("Venus"));
        sp.add(new Planet("Earth"));
        sp.add(new Planet("Mars"));
        sp.add(new Planet("Jupiter"));
        sp.add(new Planet("Saturn"));
        sp.add(new Planet("Uranus"));
        sp.add(new Planet("Neptune"));
        sp.add(new Planet("Fomalhaut b"));
        Planet p1 = new Planet("51 Pegasi b");
        sp.add(p1);
        Planet p2 = new Planet("51 Pegasi b");
        sp.add(p2);
        System.out.println(p1.equals(p2));
        System.out.println(sp);
    }
}

class Planet
{
    private String name;

    Planet(String name)
    {
        this.name = name;
    }

    @Override
    public boolean equals(Object o)
    {
        if (!(o instanceof Planet))
            return false;
    }
}
```

```

    Planet p = (Planet) o;
    return p.name.equals(name);
}

String getName()
{
    return name;
}

@Override
public String toString()
{
    return name;
}
}

```

Listing 9-5's Planet class declares a single name field of type String. Although it might seem pointless to declare Planet with a single String field because I could refactor this listing to remove Planet and work with String, I might want to introduce additional fields to Planet (perhaps to store a planet's mass and other characteristics) in the future.

When you run this application, it generates unordered output such as the following:

```

true
[Neptune, Mars, Mercury, Fomalhaut b, Venus, 51 Pegasi b, 51 Pegasi b, Jupiter, Saturn, Earth, Uranus]

```

This output reveals two 51 Pegasi b elements in the hashset. Although these elements are equal from the perspective of the overriding equals() method (the first output line, true, proves this point), overriding equals() isn't enough to avoid duplicate elements being stored in a hashset: you must also override hashCode().

The easiest way to override hashCode() in Listing 9-5's Planet class is to have the overriding method call the name field's hashCode() method and return its value. (This technique only works with a class whose single reference field's class provides a valid hashCode() method.) Listing 9-6 presents this overriding hashCode() method.

*Listing 9-6. A Custom Planet Class Overriding hashCode()*

```

import java.util.HashSet;
import java.util.Set;

public class CustomClassAndHashSet
{
    public static void main(String[] args)
    {
        Set<Planet> sp = new HashSet<Planet>();
        sp.add(new Planet("Mercury"));
        sp.add(new Planet("Venus"));
        sp.add(new Planet("Earth"));
        sp.add(new Planet("Mars"));
        sp.add(new Planet("Jupiter"));
        sp.add(new Planet("Saturn"));
    }
}

```

```
    sp.add(new Planet("Uranus"));
    sp.add(new Planet("Neptune"));
    sp.add(new Planet("Fomalhaut b"));
    Planet p1 = new Planet("51 Pegasi b");
    sp.add(p1);
    Planet p2 = new Planet("51 Pegasi b");
    sp.add(p2);
    System.out.println(p1.equals(p2));
    System.out.println(sp);
}
}
```

```
class Planet
{
    private String name;

    Planet(String name)
    {
        this.name = name;
    }

    @Override
    public boolean equals(Object o)
    {
        if (!(o instanceof Planet))
            return false;
        Planet p = (Planet) o;
        return p.name.equals(name);
    }

    String getName()
    {
        return name;
    }

    @Override
    public int hashCode()
    {
        return name.hashCode();
    }

    @Override
    public String toString()
    {
        return name;
    }
}
```

Compile Listing 9-6 (`javac CustomClassAndHashSet.java`) and run the application (`java CustomClassAndHashSet`). You will observe output (similar to that shown below) that reveals no duplicate elements:

```
true
[Saturn, Earth, Uranus, Fomalhaut b, 51 Pegasi b, Venus, Jupiter, Mercury, Mars, Neptune]
```

**Note** `LinkedHashSet` is a subclass of `HashSet` that uses a linked list to store its elements. As a result, `LinkedHashSet`'s iterator returns elements in the order in which they were inserted. For example, if Listing 9-4 had specified `Set<String> ss = new LinkedHashSet<String>()`, the application's output would have been `ss: apples pears grapes bananas kiwis null`. Also, `LinkedHashSet` offers slower performance than `HashSet` and faster performance than `TreeSet`.

## EnumSet

In Chapter 6, I introduced you to traditional enumerated types and their enum replacement. (An *enum* is an enumerated type that is expressed via reserved word `enum`.) The following example demonstrates the traditional enumerated type:

```
static final int SUNDAY = 1;
static final int MONDAY = 2;
static final int TUESDAY = 4;
static final int WEDNESDAY = 8;
static final int THURSDAY = 16;
static final int FRIDAY = 32;
static final int SATURDAY = 64;
```

Although the enum has many advantages over the traditional enumerated type, the traditional enumerated type is less awkward to use when combining constants into a set, for example, `static final int DAYS_OFF = SUNDAY | MONDAY;`

`DAYS_OFF` is an example of an integer-based, fixed-length *bitset*, which is a set of bits where each bit indicates that its associated member belongs to the set when the bit is set to 1 and is absent from the set when the bit is set to 0.

**Note** An `int`-based bitset cannot contain more than 32 members because `int` has a size of 32 bits. Similarly, a `long`-based bitset cannot contain more than 64 members because `long` has a size of 64 bits.

This bitset is formed by bitwise inclusive ORing the traditional enumerated type's integer constants together via the bitwise inclusive OR operator (`|`): you could also use `+`. Each constant must be a unique power of two (starting with one) because otherwise it's impossible to distinguish between the members of this bitset.

To determine if a constant belongs to the bitset, create an expression that involves the bitwise AND operator (&). For example, `((DAYS_OFF & MONDAY) == MONDAY)` bitwise ANDs `DAYS_OFF` (3) with `MONDAY` (2), which results in 2. This value is compared via `==` with `MONDAY` (2), and the result of the expression is true: `MONDAY` is a member of the `DAYS_OFF` bitset.

You can accomplish the same task with an enum by instantiating an appropriate Set implementation class and calling the `add()` method multiple times to store the constants in the set. Listing 9-7 illustrates this more awkward alternative.

*Listing 9-7. Creating the Set Equivalent of DAYS\_OFF*

```
import java.util.Set;
import java.util.TreeSet;

enum Weekday
{
    SUNDAY, MONDAY, TUESDAY, WEDNESDAY, THURSDAY, FRIDAY, SATURDAY
}

public class DaysOff
{
    public static void main(String[] args)
    {
        Set<Weekday> daysOff = new TreeSet<Weekday>();
        daysOff.add(Weekday.SUNDAY);
        daysOff.add(Weekday.MONDAY);
        System.out.println(daysOff);
    }
}
```

When you run this application, it generates the following output:

```
[SUNDAY, MONDAY]
```

**Note** The constants' ordinals and not their names are stored in the tree set, which is why the names appear unordered (S before M) even though the constants are stored in sorted order of their ordinals.

As well as being more awkward to use (and verbose) than the bitset, the Set alternative requires more memory to store each constant and isn't as fast. Because of these problems, EnumSet was introduced.

The EnumSet class provides a Set implementation that is based on a bitset. Its elements are constants that must come from the same enum, which is specified when the enum set is created. Null elements are not permitted; any attempt to store a null element results in a thrown `NullPointerException`.



Listing 9-8 demonstrates EnumSet.

*Listing 9-8. Creating the EnumSet Equivalent of DAYS\_OFF*

```
import java.util.EnumSet;
import java.util.Iterator;
import java.util.Set;

enum Weekday
{
    SUNDAY, MONDAY, TUESDAY, WEDNESDAY, THURSDAY, FRIDAY, SATURDAY
}

public class EnumSetDemo
{
    public static void main(String[] args)
    {
        Set<Weekday> daysOff = EnumSet.of(Weekday.SUNDAY, Weekday.MONDAY);
        Iterator<Weekday> iter = daysOff.iterator();
        while (iter.hasNext())
            System.out.println(iter.next());
    }
}
```

EnumSetDemo takes advantage of the fact that EnumSet, whose generic type is EnumSet<E> extends Enum<E>, provides various class methods for conveniently constructing enum sets. For example, <E extends Enum<E>> EnumSet<E> of(E e1, E e2) returns an EnumSet instance consisting of elements e1 and e2. In this example, those elements are Weekday.SUNDAY and Weekday.MONDAY.

When you run this application, it generates the following output:

```
SUNDAY
MONDAY
```

**Note** As well as providing several overloaded of() methods, EnumSet provides other methods for conveniently creating enum sets. For example, allOf() returns an EnumSet instance that contains all of an enum's constants, where this method's solitary argument is a *class literal* (an expression consisting of a class's name followed by a dot followed by reserved word `class`) that identifies the enum:

```
Set<Weekday> allWeekDays = EnumSet.allOf(Weekday.class);
```

Similarly, range() returns an EnumSet instance containing a range of an enum's elements (with the range's limits as specified by this method's two arguments):

```
for (WeekDay wd: EnumSet.range(WeekDay.MONDAY, WeekDay.FRIDAY))
    System.out.println(wd);
```

## Exploring Sorted Sets

`TreeSet` is an example of a *sorted set*, which is a set that maintains its elements in ascending order, sorted according to their natural ordering or according to a comparator that is supplied when the sorted set is created. Sorted sets are described by the `SortedSet` interface.

`SortedSet`, whose generic type is `SortedSet<E>`, extends `Set`. With two exceptions, the methods it inherits from `Set` behave identically on sorted sets as on other sets:

- The `Iterator` instance returned from `iterator()` traverses the sorted set in ascending element order.
- The array returned by `toArray()` contains the sorted set's elements in order.

**Note** Although not guaranteed, the `toString()` methods of `SortedSet` implementations in the Collections Framework (such as `TreeSet`) return a string containing all of the sorted set's elements in order.

`SortedSet`'s documentation requires that an implementation provide the four standard constructors that I presented in my discussion of `TreeSet`. Furthermore, implementations of this interface must implement the methods that are described in Table 9-3.

**Table 9-3.** *SortedSet-Specific Methods*

Method	Description
<code>Comparator&lt;? super E&gt; comparator()</code>	Returns the comparator used to order the elements in this set or null when this set uses the natural ordering of its elements.
<code>E first()</code>	Returns the first (lowest) element currently in this set, or throws a <code>NoSuchElementException</code> instance when this set is empty.
<code>SortedSet&lt;E&gt; headSet(E toElement)</code>	Returns a view of that portion of this set whose elements are strictly less than <code>toElement</code> . The returned set is backed by this set, so changes in the returned set are reflected in this set and vice versa. The returned set supports all optional set operations that this set supports. This method throws <code>ClassCastException</code> when <code>toElement</code> is not compatible with this set's comparator (or, when the set has no comparator, when <code>toElement</code> doesn't implement <code>Comparable</code> ), <code>NullPointerException</code> when <code>toElement</code> is null and this set doesn't permit null elements, and <code>IllegalArgumentException</code> when this set has a restricted range and <code>toElement</code> lies outside of this range's bounds.
<code>E last()</code>	Returns the last (highest) element currently in this set, or throws a <code>NoSuchElementException</code> instance when this set is empty.

(continued)

Table 9-3. (continued)

Method	Description
SortedSet<E> subSet(E fromElement, E toElement)	Returns a view of the portion of this set whose elements range from fromElement, inclusive, to toElement, exclusive. (When fromElement and toElement are equal, the returned set is empty.) The returned set is backed by this set, so changes in the returned set are reflected in this set and vice versa. The returned set supports all optional set operations that this set supports. This method throws ClassCastException when fromElement and toElement cannot be compared to one another using this set's comparator (or, when the set has no comparator, using natural ordering), NullPointerException when fromElement or toElement is null and this set doesn't permit null elements, and IllegalArgumentException when fromElement is greater than toElement or when this set has a restricted range and fromElement or toElement lies outside of this range's bounds.
SortedSet<E> tailSet(E fromElement)	Returns a view of that portion of this set whose elements are greater than or equal to fromElement. The returned set is backed by this set, so changes in the returned set are reflected in this set and vice versa. The returned set supports all optional set operations that this set supports. This method throws ClassCastException when fromElement is not compatible with this set's comparator (or, when the set has no comparator, when fromElement doesn't implement Comparable), NullPointerException when fromElement is null and this set doesn't permit null elements, and IllegalArgumentException when this set has a restricted range and fromElement lies outside of the range's bounds.

The set-based range views returned from `headSet()`, `subSet()`, and `tailSet()` are analogous to the list-based range view returned from `List`'s `subList()` method except that a set-based range view remains valid even when the backing sorted set is modified. As a result, a set-based range view can be used for a lengthy period of time.

**Note** Unlike a list-based range view whose endpoints are elements in the backing list, the endpoints of a set-based range view are absolute points in element space, allowing a set-based range view to serve as a window onto a portion of the set's element space. Any changes made to the set-based range view are written back to the backing sorted set and vice versa.

Each range view returned by `headSet()`, `subSet()`, or `tailSet()` is *half open* because it doesn't include its high endpoint (`headSet()` and `subSet()`) or its low endpoint (`tailSet()`). For the first two methods, the high endpoint is specified by argument `toElement`; for the last method, the low endpoint is specified by argument `fromElement`.

**Note** You could also regard the returned range view as being *half closed* because it includes only one of its endpoints.

Listing 9-9 demonstrates a sorted set based on a tree set.

*Listing 9-9. A Sorted Set of Fruit and Vegetable Names*

```
import java.util.SortedSet;
import java.util.TreeSet;

public class SortedSetDemo
{
    public static void main(String[] args)
    {
        SortedSet<String> sss = new TreeSet<String>();
        String[] fruitAndVeg =
        {
            "apple", "potato", "turnip", "banana", "corn", "carrot", "cherry",
            "pear", "mango", "strawberry", "cucumber", "grape", "banana",
            "kiwi", "radish", "blueberry", "tomato", "onion", "raspberry",
            "lemon", "pepper", "squash", "melon", "zucchini", "peach", "plum",
            "turnip", "onion", "nectarine"
        };
        System.out.println("Array size = " + fruitAndVeg.length);
        for (String fruitVeg: fruitAndVeg)
            sss.add(fruitVeg);
        dump("sss:", sss);
        System.out.println("Sorted set size = " + sss.size());
        System.out.println("First element = " + sss.first());
        System.out.println("Last element = " + sss.last());
        System.out.println("Comparator = " + sss.comparator());
        dump("hs:", sss.headSet("n"));
        dump("ts:", sss.tailSet("n"));
        System.out.println("Count of p-named fruits & vegetables = " +
            sss.subSet("p", "q").size());
        System.out.println("Incorrect count of c-named fruits & vegetables = " +
            sss.subSet("carrot", "cucumber").size());
        System.out.println("Correct count of c-named fruits & vegetables = " +
            sss.subSet("carrot", "cucumber\0").size());
    }

    static void dump(String title, SortedSet<String> sss)
    {
        System.out.print(title + " ");
        for (String s: sss)
            System.out.print(s + " ");
        System.out.println();
    }
}
```

SortedSetDemo creates a sorted set and an array of fruit and vegetable names and then proceeds to populate the set from this array. After dumping out the set's contents, it outputs information about the set, including head and tail views of portions of the set.

When you run this application, it generates the following output:

```

Array size = 29
sss: apple banana blueberry carrot cherry corn cucumber grape kiwi lemon mango melon nectarine
onion peach pear pepper plum potato radish raspberry squash strawberry tomato turnip zucchini
Sorted set size = 26
First element = apple
Last element = zucchini
Comparator = null
hs: apple banana blueberry carrot cherry corn cucumber grape kiwi lemon mango melon
ts: nectarine onion peach pear pepper plum potato radish raspberry squash strawberry tomato
turnip zucchini
Count of p-named fruits & vegetables = 5
Incorrect count of c-named fruits & vegetables = 3
Correct count of c-named fruits & vegetables = 4

```

This output reveals that the sorted set's size is less than the array's size because a set cannot contain duplicate elements: the duplicate banana, turnip, and onion elements are not stored in the sorted set.

The `comparator()` method returns `null` because the sorted set was not created with a comparator. Instead, the sorted set relies on the natural ordering of `String` elements to store them in sorted order.

The `headSet()` and `tailSet()` methods are called with argument `"n"` to return, respectively, a set of elements whose names begin with a letter that is strictly less than `n`, and a letter that is greater than or equal to `n`.

Finally, the output shows you that you must be careful when passing an upper limit to `subSet()`. As you can see, `ss.subSet("carrot", "cucumber")` doesn't include cucumber in the returned range view because cucumber is `subSet()`'s high endpoint.

To include cucumber in the range view, you need to form a *closed range* or *closed interval* (both endpoints are included). With `String` objects, you accomplish this task by appending `\0` to the string. For example, `ss.subSet("carrot", "cucumber\0")` includes cucumber because it is less than `cucumber\0`.

This same technique can be applied wherever you need to form an *open range* or *open interval* (neither endpoint is included). For example, `ss.subSet("carrot\0", "cucumber")` doesn't include carrot because it is less than `carrot\0`. Furthermore, it doesn't include high endpoint cucumber.

**Note** When you want to create closed and open ranges for elements created from your own classes, you need to provide some form of `predecessor()` and `successor()` methods that return an element's predecessor and successor.

You need to be careful when designing classes that work with sorted sets. For example, the class must implement `Comparable` when you plan to store the class's instances in a sorted set where these elements are sorted according to their natural ordering. Consider Listing 9-10.

*Listing 9-10. A Custom Employee Class Not Implementing Comparable*

```
import java.util.SortedSet;
import java.util.TreeSet;

public class CustomClassAndSortedSet
{
    public static void main(String[] args)
    {
        SortedSet<Employee> sse = new TreeSet<Employee>();
        sse.add(new Employee("Sally Doe"));
        sse.add(new Employee("Bob Doe")); // ClassCastException thrown here
        sse.add(new Employee("John Doe"));
        System.out.println(sse);
    }
}

class Employee
{
    private String name;

    Employee(String name)
    {
        this.name = name;
    }

    @Override
    public String toString()
    {
        return name;
    }
}
```

When you run this application, it generates the following output:

```
Exception in thread "main" java.lang.ClassCastException: Employee cannot be cast to
java.lang.Comparable
    at java.util.TreeMap.compare(Unknown Source)
    at java.util.TreeMap.put(Unknown Source)
    at java.util.TreeSet.add(Unknown Source)
    at CustomClassAndSortedSet.main(CustomClassAndSortedSet.java:9)
```

The `ClassCastException` instance is thrown during the second `add()` method call because the sorted set implementation, an instance of `TreeSet`, is unable to call the second `Employee` element's `compareTo()` method, because `Employee` doesn't implement `Comparable`.

The solution to this problem is to have the class implement `Comparable`, which is exactly what is revealed in Listing 9-11.

*Listing 9-11. Making Employee Elements Comparable*

```

import java.util.SortedSet;
import java.util.TreeSet;

public class CustomClassAndSortedSet
{
    public static void main(String[] args)
    {
        SortedSet<Employee> sse = new TreeSet<Employee>();
        sse.add(new Employee("Sally Doe"));
        sse.add(new Employee("Bob Doe"));
        Employee e1 = new Employee("John Doe");
        Employee e2 = new Employee("John Doe");
        sse.add(e1);
        sse.add(e2);
        System.out.println(sse);
        System.out.println(e1.equals(e2));
    }
}

class Employee implements Comparable<Employee>
{
    private String name;

    Employee(String name)
    {
        this.name = name;
    }

    @Override
    public int compareTo(Employee e)
    {
        return name.compareTo(e.name);
    }

    @Override
    public String toString()
    {
        return name;
    }
}

```

Listing 9-11's `main()` method differs from Listing 9-10 in that it also creates two `Employee` objects initialized to "John Doe," adds these objects to the sorted set, and compares these objects for equality via `equals()`. Furthermore, Listing 9-11 declares `Employee` to implement `Comparable`, introducing a `compareTo()` method into `Employee`.

When you run this application, it generates the following output:

```

[Bob Doe, John Doe, Sally Doe]
false

```

This output shows that only one "John Doe" Employee object is stored in the sorted set. After all, a set cannot contain duplicate elements. However, the false value (resulting from the equals() comparison) also shows that the sorted set's natural ordering is inconsistent with equals(), which violates SortedSet's contract:

*The ordering maintained by a sorted set (whether or not an explicit comparator is provided) must be consistent with equals() if the sorted set is to correctly implement the Set interface. This is so because the Set interface is defined in terms of the equals() operation, but a sorted set performs all element comparisons using its compareTo() (or compare()) method, so two elements that are deemed equal by this method are, from the standpoint of the sorted set, equal.*

Because the application works correctly, why should SortedSet's contract matter? Although the contract doesn't appear to matter with respect to the TreeSet implementation of SortedSet, perhaps it will matter in the context of a third-party class that implements this interface.

Listing 9-12 shows you how to correct this problem and make Employee instances work with any implementation of a sorted set.

*Listing 9-12. A Contract-Compliant Employee Class*

```
import java.util.SortedSet;
import java.util.TreeSet;

public class CustomClassAndSortedSet
{
    public static void main(String[] args)
    {
        SortedSet<Employee> sse = new TreeSet<Employee>();
        sse.add(new Employee("Sally Doe"));
        sse.add(new Employee("Bob Doe"));
        Employee e1 = new Employee("John Doe");
        Employee e2 = new Employee("John Doe");
        sse.add(e1);
        sse.add(e2);
        System.out.println(sse);
        System.out.println(e1.equals(e2));
    }
}

class Employee implements Comparable<Employee>
{
    private String name;

    Employee(String name)
    {
        this.name = name;
    }

    @Override
    public int compareTo(Employee e)
    {
        return name.compareTo(e.name);
    }
}
```



```

@Override
public boolean equals(Object o)
{
    if (!(o instanceof Employee))
        return false;
    Employee e = (Employee) o;
    return e.name.equals(name);
}

@Override
public String toString()
{
    return name;
}
}

```

Listing 9-12 corrects the `SortedSet` contract violation by overriding `equals()`. Run the resulting application and you will observe `[Bob Doe, John Doe, Sally Doe]` as the first line of output and `true` as the second line: the sorted set's natural ordering is now consistent with `equals()`.

**Note** Although it's important to override `hashCode()` whenever you override `equals()`, I didn't override `hashCode()` (although I overrode `equals()`) in Listing 9-12's `Employee` class to emphasize that tree-based sorted sets ignore `hashCode()`.

## Exploring Navigable Sets

`TreeSet` is an example of a *navigable set*, which is a sorted set that can be iterated over in descending order as well as ascending order and which can report closest matches for given search targets. Navigable sets are described by the `NavigableSet` interface, whose generic type is `NavigableSet<E>`, which extends `SortedSet`, and which is described in Table 9-4.

**Table 9-4.** *NavigableSet-Specific Methods*

Method	Description
<code>E ceiling(E e)</code>	Returns the least element in this set greater than or equal to <code>e</code> , or <code>null</code> when there is no such element. This method throws <code>ClassCastException</code> when <code>e</code> cannot be compared with the elements currently in the set and <code>NullPointerException</code> when <code>e</code> is <code>null</code> and this set doesn't permit <code>null</code> elements.
<code>Iterator&lt;E&gt; descendingIterator()</code>	Returns an iterator over the elements in this set, in descending order. Equivalent in effect to <code>descendingSet().iterator()</code> .
<code>NavigableSet&lt;E&gt; descendingSet()</code>	Returns a reverse order view of the elements contained in this set. The descending set is backed by this set, so changes to the set are reflected in the descending set and vice versa. If either set is modified (except through the iterator's own <code>remove()</code> operation) while iterating over the set, the results of the iteration are undefined.

(continued)

Table 9-4. (continued)

Method	Description
<code>E floor(E e)</code>	Returns the greatest element in this set less than or equal to <code>e</code> or null when there is no such element. This method throws <code>ClassCastException</code> when <code>e</code> cannot be compared with the elements currently in the set and <code>NullPointerException</code> when <code>e</code> is null and this set doesn't permit null elements.
<code>NavigableSet&lt;E&gt; headSet(E toElement, boolean inclusive)</code>	Returns a view of the portion of this set whose elements are less than (or equal to, when <code>inclusive</code> is true) <code>toElement</code> . The returned set is backed by this set, so changes in the returned set are reflected in this set and vice versa. The returned set supports all optional set operations that this set supports. This method throws <code>ClassCastException</code> when <code>toElement</code> is not compatible with this set's comparator (or, when the set has no comparator, when <code>toElement</code> doesn't implement <code>Comparable</code> ), <code>NullPointerException</code> when <code>toElement</code> is null and this set doesn't permit null elements, and <code>IllegalArgumentException</code> when this set has a restricted range and <code>toElement</code> lies outside of this range's bounds.
<code>E higher(E e)</code>	Returns the least element in this set strictly greater than the given element or null when there is no such element. This method throws <code>ClassCastException</code> when <code>e</code> cannot be compared with the elements currently in the set and <code>NullPointerException</code> when <code>e</code> is null and this set doesn't permit null elements.
<code>E lower(E e)</code>	Returns the greatest element in this set strictly less than the given element or null when there is no such element. This method throws <code>ClassCastException</code> when <code>e</code> cannot be compared with the elements currently in the set and <code>NullPointerException</code> when <code>e</code> is null and this set doesn't permit null elements.
<code>E pollFirst()</code>	Returns and removes the first (lowest) element from this set, or returns null when this set is empty.
<code>E pollLast()</code>	Returns and removes the last (highest) element from this set, or returns null when this set is empty.
<code>NavigableSet&lt;E&gt; subSet(E fromElement, boolean fromInclusive, E toElement, boolean toInclusive)</code>	Returns a view of the portion of this set whose elements range from <code>fromElement</code> to <code>toElement</code> . (When <code>fromElement</code> and <code>toElement</code> are equal, the returned set is empty unless <code>fromInclusive</code> and <code>toInclusive</code> are both true.) The returned set is backed by this set, so changes in the returned set are reflected in this set and vice versa. The returned set supports all optional set operations that this set supports. This method throws <code>ClassCastException</code> when <code>fromElement</code> and <code>toElement</code> cannot be compared to one another using this set's comparator (or, when the set has no comparator, using natural ordering), <code>NullPointerException</code> when <code>fromElement</code> or <code>toElement</code> is null and this set doesn't permit null elements, and <code>IllegalArgumentException</code> when <code>fromElement</code> is greater than <code>toElement</code> or when this set has a restricted range and <code>fromElement</code> or <code>toElement</code> lies outside of this range's bounds.

(continued)

**Table 9-4.** (continued)

Method	Description
<code>NavigableSet&lt;E&gt; tailSet(E fromElement, boolean inclusive)</code>	Returns a view of the portion of this set whose elements are greater than (or equal to, when <code>inclusive</code> is true) <code>fromElement</code> . The returned set is backed by this set, so changes in the returned set are reflected in this set and vice versa. The returned set supports all optional set operations that this set supports. This method throws <code>ClassCastException</code> when <code>fromElement</code> is not compatible with this set's comparator (or, when the set has no comparator, when <code>fromElement</code> doesn't implement <code>Comparable</code> ), <code>NullPointerException</code> when <code>fromElement</code> is null and this set doesn't permit null elements, and <code>IllegalArgumentException</code> when this set has a restricted range and <code>fromElement</code> lies outside of this range's bounds.

Listing 9-13 demonstrates a navigable set based on a tree set.

**Listing 9-13.** *Navigating a Set of Integers*

```
import java.util.Iterator;
import java.util.NavigableSet;
import java.util.TreeSet;

public class NavigableSetDemo
{
    public static void main(String[] args)
    {
        NavigableSet<Integer> ns = new TreeSet<Integer>();
        int[] ints = { 82, -13, 4, 0, 11, -6, 9 };
        for (int i: ints)
            ns.add(i);
        System.out.print("Ascending order: ");
        Iterator iter = ns.iterator();
        while (iter.hasNext())
            System.out.print(iter.next() + " ");
        System.out.println();
        System.out.print("Descending order: ");
        iter = ns.descendingIterator();
        while (iter.hasNext())
            System.out.print(iter.next() + " ");
        System.out.println("\n");
        outputClosestMatches(ns, 4);
        outputClosestMatches(ns.descendingSet(), 12);
    }

    static void outputClosestMatches(NavigableSet<Integer> ns, int i)
    {
        System.out.println("Element < " + i + " is " + ns.lower(i));
        System.out.println("Element <= " + i + " is " + ns.floor(i));
        System.out.println("Element > " + i + " is " + ns.higher(i));
        System.out.println("Element >= " + i + " is " + ns.ceiling(i));
        System.out.println();
    }
}
```

Listing 9-13 creates a navigable set of Integer elements. It takes advantage of autoboxing to ensure that ints are converted to Integers.

When you run this application, it generates the following output:

```
Ascending order: -13 -6 0 4 9 11 82
Descending order: 82 11 9 4 0 -6 -13
```

```
Element < 4 is 0
Element <= 4 is 4
Element > 4 is 9
Element >= 4 is 4
```

```
Element < 12 is 82
Element <= 12 is 82
Element > 12 is 11
Element >= 12 is 11
```

The first four output lines beginning with `Element` pertain to an ascending-order set where the element being matched (4) is a member of the set. The second four `Element`-prefixed lines pertain to a descending-order set where the element being matched (12) is not a member.

As well as letting you conveniently locate set elements via its closest-match methods (`ceiling()`, `floor()`, `higher()`, and `lower()`), `NavigableSet` lets you return set views containing all elements within certain ranges, as demonstrated by the following examples:

- `ns.subSet(-13, true, 9, true)`: Returns all elements from -13 through 9.
- `ns.tailSet(-6, false)`: Returns all elements greater than -6.
- `ns.headSet(4, true)`: Returns all elements less than or equal to 4.

Finally, you can return and remove from the set the first (lowest) element by calling `pollFirst()` and the last (highest) element by calling `pollLast()`. For example, `ns.pollFirst()` removes and returns -13, and `ns.pollLast()` removes and returns 82.

## Exploring Queues

A *queue* is a collection in which elements are stored and retrieved in a specific order. Most queues are categorized as one of the following:

- *First-In, First-Out (FIFO) queue*: Elements are inserted at the queue's *tail* and removed at the queue's *head*.
- *Last-In, First-Out (LIFO) queue*: Elements are inserted and removed at one end of the queue such that the last element inserted is the first element retrieved. This kind of queue behaves as a *stack*.
- *Priority queue*: Elements are inserted according to their natural ordering or according to a comparator that is supplied to the queue implementation.

`Queue`, whose generic type is `Queue<E>`, extends `Collection`, redeclaring `add()` to adjust its contract (insert the specified element into this queue if it's possible to do so immediately without violating capacity restrictions), and inheriting the other methods from `Collection`. Table 9-5 describes `add()` and the other `Queue`-specific methods.

Table 9-5 reveals two sets of methods: in one set, a method (such as `add()`) throws an exception when an operation fails; in the other set, a method (such as `offer()`) returns a special value (`false` or `null`) in the presence of failure. The methods that return a special value are useful in the context of capacity-restricted `Queue` implementations where failure is a normal occurrence.

**Table 9-5.** *Queue-Specific Methods*

Method	Description
<code>boolean add(E e)</code>	Inserts element <code>e</code> into this queue if it is possible to do so immediately without violating capacity restrictions. Returns <code>true</code> on success; otherwise, throws <code>IllegalStateException</code> when the element cannot be added at this time because no space is currently available. This method also throws <code>ClassCastException</code> when <code>e</code> 's class prevents <code>e</code> from being added to this queue, <code>NullPointerException</code> when <code>e</code> contains the null reference and this queue doesn't permit null elements to be added, and <code>IllegalArgumentException</code> when some property of <code>e</code> prevents it from being added to this queue.
<code>E element()</code>	Returns but doesn't also remove the element at the head of this queue. This method throws <code>NoSuchElementException</code> when this queue is empty.
<code>boolean offer(E e)</code>	Inserts element <code>e</code> into this queue if it is possible to do so immediately without violating capacity restrictions. Returns <code>true</code> on success; otherwise, returns <code>false</code> when the element cannot be added at this time because no space is currently available. This method throws <code>ClassCastException</code> when <code>e</code> 's class prevents <code>e</code> from being added to this queue, <code>NullPointerException</code> when <code>e</code> contains the null reference and this queue doesn't permit null elements to be added, and <code>IllegalArgumentException</code> when some property of <code>e</code> prevents it from being added to this queue.
<code>E peek()</code>	Returns but doesn't also remove the element at the head of this queue. This method returns <code>null</code> when this queue is empty.
<code>E poll()</code>	Returns and also removes the element at the head of this queue. This method returns <code>null</code> when this queue is empty.
<code>E remove()</code>	Returns and also removes the element at the head of this queue. This method throws <code>NoSuchElementException</code> when this queue is empty. This is the only difference between <code>remove()</code> and <code>poll()</code> .

**Note** The `offer()` method is generally preferable to `add()` when using a capacity-restricted queue because `offer()` doesn't throw `IllegalStateException`.

Java supplies many Queue implementation classes, where most of these classes are members of the `java.util.concurrent` package: `LinkedBlockingQueue` and `SynchronousQueue` are examples. In contrast, the `java.util` package provides `LinkedList` and `PriorityQueue` as its Queue implementation classes.

**Caution** Many Queue implementation classes don't allow null elements to be added. However, some classes (such as `LinkedList`) permit null elements. You should avoid adding a null element because null is used as a special return value by the `peek()` and `poll()` methods to indicate that a queue is empty.

## PriorityQueue

The `PriorityQueue` class provides an implementation of a *priority queue*, which is a queue that orders its elements according to their natural ordering or by a comparator provided when the queue is instantiated. Priority queues don't permit null elements and don't permit insertion of non-Comparable objects when relying on natural ordering.

The element at the head of the priority queue is the least element with respect to the specified ordering. When multiple elements are tied for least element, one of those elements is arbitrarily chosen as the least element. Similarly, the element at the tail of the priority queue is the greatest element, which is arbitrarily chosen when there is a tie.

Priority queues are unbounded but have a capacity that governs the size of the internal array that is used to store the priority queue's elements. The capacity value is at least as large as the queue's length, and grows automatically as elements are added to the priority queue.

`PriorityQueue` (whose generic type is `PriorityQueue<E>`) supplies six constructors:

- `PriorityQueue()` creates a `PriorityQueue` instance with an initial capacity of 11 elements and which orders its elements according to their natural ordering.
- `PriorityQueue(Collection<? extends E> c)` creates a `PriorityQueue` instance containing `c`'s elements. If `c` is a `SortedSet` or `PriorityQueue` instance, this priority queue will be ordered according to the same ordering. Otherwise, this priority queue will be ordered according to the natural ordering of its elements. This constructor throws `ClassCastException` when `c`'s elements cannot be compared to one another according to the priority queue's ordering and `NullPointerException` when `c` or any of its elements contain the null reference.
- `PriorityQueue(int initialCapacity)` creates a `PriorityQueue` instance with the specified `initialCapacity` and which orders its elements according to their natural ordering. This constructor throws `IllegalArgumentException` when `initialCapacity` is less than 1.
- `PriorityQueue(int initialCapacity, Comparator<? super E> comparator)` creates a `PriorityQueue` instance with the specified `initialCapacity` and which orders its elements according to the specified comparator. Natural ordering is used when `comparator` contains the null reference. This constructor throws `IllegalArgumentException` when `initialCapacity` is less than 1.

- `PriorityQueue(PriorityQueue<? extends E> pq)` creates a `PriorityQueue` instance containing `pq`'s elements. This priority queue will be ordered according to the same ordering as `pq`. This constructor throws `ClassCastException` when `pq`'s elements cannot be compared to one another according to `pq`'s ordering and `NullPointerException` when `pq` or any of its elements contains the null reference.
- `PriorityQueue(SortedSet<? extends E> ss)` creates a `PriorityQueue` instance containing `ss`'s elements. This priority queue will be ordered according to the same ordering as `ss`. This constructor throws `ClassCastException` when `ss`'s elements cannot be compared to one another according to `ss`'s ordering and `NullPointerException` when `ss` or any of its elements contains the null reference.

Listing 9-14 demonstrates a priority queue.

*Listing 9-14. Adding Randomly Generated Integers to a Priority Queue*

```
import java.util.PriorityQueue;
import java.util.Queue;

public class PriorityQueueDemo
{
    public static void main(String[] args)
    {
        Queue<Integer> qi = new PriorityQueue<Integer>();
        for (int i = 0; i < 15; i++)
            qi.add((int) (Math.random() * 100));
        while (!qi.isEmpty())
            System.out.print(qi.poll() + " ");
        System.out.println();
    }
}
```

After creating a priority queue, `PriorityQueueDemo`'s main thread adds 15 randomly generated integers (ranging from 0 through 99) to this queue. It then enters a while loop that repeatedly polls the priority queue for the next element and outputs that element until the queue is empty.

When you run this application, it outputs a line of 15 integers in ascending numerical order from left to right. For example, I observed the following output from one run:

```
30 43 53 61 61 66 66 67 76 78 80 83 87 90 97
```

Because `poll()` returns null when there are no more elements, I could have coded this loop as follows:

```
Integer i;
while ((i = qi.poll()) != null)
    System.out.print(i + " ");
```

Suppose you want to reverse the order of the previous example's output so that the largest element appears on the left and the smallest element appears on the right. As Listing 9-15 demonstrates, you can achieve this task by passing a comparator to the appropriate `PriorityQueue` constructor.

*Listing 9-15. Using a Comparator with a Priority Queue*

```
import java.util.Comparator;
import java.util.PriorityQueue;
import java.util.Queue;

public class PriorityQueueDemo
{
    final static int NELEM = 15;

    public static void main(String[] args)
    {
        Comparator<Integer> cmp;
        cmp = new Comparator<Integer>()
        {
            @Override
            public int compare(Integer e1, Integer e2)
            {
                return e2 - e1;
            }
        };
        Queue<Integer> qi = new PriorityQueue<Integer>(NELEM, cmp);
        for (int i = 0; i < NELEM; i++)
            qi.add((int) (Math.random() * 100));
        while (!qi.isEmpty())
            System.out.print(qi.poll() + " ");
        System.out.println();
    }
}
```

Listing 9-15 is similar to Listing 9-14, but there are some differences. First, I have declared a constant named `NELEM` so that I can easily change both the priority queue's initial capacity and the number of elements inserted into the priority queue by specifying the new value in one place.

Second, Listing 9-15 declares and instantiates an anonymous class that implements `Comparator`. Its `compareTo()` method subtracts element `e2` from element `e1` to achieve descending numerical order. The compiler handles the task of unboxing `e2` and `e1` by converting `e2 - e1` to `e2.intValue() - e1.intValue()`.

Finally, Listing 9-15 passes an initial capacity of `NELEM` elements and the instantiated comparator to the `PriorityQueue(int initialCapacity, Comparator<? super E> comparator)` constructor. The priority queue will use this comparator to order these elements.

Run this application and you will now see a single output line of 15 integers shown in descending numerical order from left to right. For example, I observed this output line:

```
97 72 70 70 67 64 56 43 36 22 9 5 3 2 1
```



## Exploring Deques

A *deque* (pronounced deck) is a double-ended queue in which element insertion or removal occurs at its *head* or *tail*. Deques can be used as queues or stacks.

Deque, whose generic type is `Deque<E>`, extends `Queue` in which the inherited `add(E e)` method inserts `e` at the deque's tail. Table 9-6 describes Deque-specific methods.

**Table 9-6.** Deque-Specific Methods

Method	Description
<code>void addFirst(E e)</code>	Inserts <code>e</code> at the head of this deque if it is possible to do so immediately without violating capacity restrictions. When using a capacity-restricted deque, it is generally preferable to use method <code>offerFirst()</code> . This method throws <code>IllegalStateException</code> when <code>e</code> cannot be added at this time because of capacity restrictions, <code>ClassCastException</code> when <code>e</code> 's class prevents <code>e</code> from being added to this deque, <code>NullPointerException</code> when <code>e</code> contains the null reference and this deque doesn't permit null elements to be added, and <code>IllegalArgumentException</code> when some property of <code>e</code> prevents it from being added to this deque.
<code>void addLast(E e)</code>	Inserts <code>e</code> at the tail of this deque if it is possible to do so immediately without violating capacity restrictions. When using a capacity-restricted deque, it is generally preferable to use method <code>offerLast()</code> . This method throws <code>IllegalStateException</code> when <code>e</code> cannot be added at this time because of capacity restrictions, <code>ClassCastException</code> when <code>e</code> 's class prevents <code>e</code> from being added to this deque, <code>NullPointerException</code> when <code>e</code> contains the null reference and this deque doesn't permit null elements to be added, and <code>IllegalArgumentException</code> when some property of <code>e</code> prevents it from being added to this deque.
<code>Iterator&lt;E&gt; descendingIterator()</code>	Returns an iterator over the elements in this deque in reverse sequential order. The elements will be returned in order from last (tail) to first (head). The inherited <code>Iterator&lt;E&gt; iterator()</code> method returns elements from the head to the tail.
<code>E element()</code>	Retrieves but doesn't remove the first element of this deque (at the head). This method differs from <code>peek()</code> only in that it throws <code>NoSuchElementException</code> when this deque is empty. This method is equivalent to <code>getFirst()</code> .
<code>E getFirst()</code>	Retrieves but doesn't remove the first element of this deque. This method differs from <code>peekFirst()</code> only in that it throws <code>NoSuchElementException</code> when this deque is empty.
<code>E getLast()</code>	Retrieves but doesn't remove the last element of this deque. This method differs from <code>peekLast()</code> only in that it throws <code>NoSuchElementException</code> when this deque is empty.

(continued)

Table 9-6. (continued)

Method	Description
<code>boolean offer(E e)</code>	Inserts <code>e</code> at the tail of this deque if it is possible to do so immediately without violating capacity restrictions, returning <code>true</code> upon success and <code>false</code> when no space is currently available. When using a capacity-restricted deque, this method is generally preferable to the <code>add()</code> method, which can fail to insert an element only by throwing an exception. This method throws <code>ClassCastException</code> when <code>e</code> 's class prevents <code>e</code> from being added to this deque, <code>NullPointerException</code> when <code>e</code> contains the null reference and this deque doesn't permit null elements to be added, and <code>IllegalArgumentException</code> when some property of <code>e</code> prevents it from being added to this deque. This method is equivalent to <code>offerLast()</code> .
<code>boolean offerFirst(E e)</code>	Inserts <code>e</code> at the head of this deque unless it would violate capacity restrictions. When using a capacity-restricted deque, this method is generally preferable to the <code>addFirst()</code> method, which can fail to insert an element only by throwing an exception. This method throws <code>ClassCastException</code> when <code>e</code> 's class prevents <code>e</code> from being added to this deque, <code>NullPointerException</code> when <code>e</code> contains the null reference and this deque doesn't permit null elements to be added, and <code>IllegalArgumentException</code> when some property of <code>e</code> prevents it from being added to this deque.
<code>boolean offerLast(E e)</code>	Inserts <code>e</code> at the tail of this deque unless it would violate capacity restrictions. When using a capacity-restricted deque, this method is generally preferable to the <code>addLast()</code> method, which can fail to insert an element only by throwing an exception. This method throws <code>ClassCastException</code> when <code>e</code> 's class prevents <code>e</code> from being added to this deque, <code>NullPointerException</code> when <code>e</code> contains the null reference and this deque doesn't permit null elements to be added, and <code>IllegalArgumentException</code> when some property of <code>e</code> prevents it from being added to this deque.
<code>E peek()</code>	Retrieves but doesn't remove the first element of this deque (at the head), or returns null when this deque is empty. This method is equivalent to <code>peekFirst()</code> .
<code>E peekFirst()</code>	Retrieves but doesn't remove the first element of this deque (at the head), or returns null when this deque is empty.
<code>E peekLast()</code>	Retrieves but doesn't remove the last element of this deque (at the tail), or returns null when this deque is empty.
<code>E poll()</code>	Retrieves and removes the first element of this deque (at the head), or returns null when this deque is empty. This method is equivalent to <code>pollFirst()</code> .

(continued)

Table 9-6. (continued)

Method	Description
E pollFirst()	Retrieves and removes the first element of this deque (at the head), or returns null when this deque is empty.
E pollLast()	Retrieves and removes the last element of this deque (at the tail), or returns null when this deque is empty.
E pop()	Pops an element from the stack represented by this deque. In other words, removes and returns the first element of this deque. This method is equivalent to removeFirst().
void push(E e)	Pushes e onto the stack represented by this deque (in other words, at the head of this deque) if it is possible to do so immediately without violating capacity restrictions, returning true upon success and throwing IllegalStateException when no space is currently available. This method also throws ClassCastException when e's class prevents e from being added to this deque, NullPointerException when e contains the null reference and this deque doesn't permit null elements to be added, and IllegalArgumentException when some property of e prevents it from being added to this deque. This method is equivalent to addFirst().
E remove()	Retrieves and removes the first element of this deque (at the head). This method differs from poll() only in that it throws NoSuchElementException when this deque is empty. This method is equivalent to removeFirst().
E removeFirst()	Retrieves and removes the first element of this deque. This method differs from pollFirst() only in that it throws NoSuchElementException when this deque is empty.
boolean removeFirstOccurrence(Object o)	Removes the first occurrence of o from this deque. If the deque doesn't contain o, it is unchanged. Returns true when this deque contained o (or equivalently, when this deque changed as a result of the call). This method throws ClassCastException when o's class prevents o from being added to this deque and NullPointerException when o contains the null reference and this deque doesn't permit null elements to be added. The inherited boolean remove(Object o) method is equivalent to this method.
E removeLast()	Retrieves and removes the last element of this deque. This method differs from pollLast() only in that it throws NoSuchElementException when this deque is empty.
boolean removeLastOccurrence(Object o)	Removes the last occurrence of o from this deque. If the deque doesn't contain o, it is unchanged. Returns true when this deque contained o (or equivalently, when this deque changed as a result of the call). This method throws ClassCastException when o's class prevents o from being added to this deque and NullPointerException when o contains the null reference and this deque doesn't permit null elements to be added.

As Table 9-6 reveals, Deque declares methods to access elements at both ends of the deque. Methods are provided to insert, remove, and examine the element. Each of these methods exists in two forms: one throws an exception when the operation fails, the other returns a special value (either null or false, depending on the operation). The latter form of the insert operation is designed specifically for use with capacity-restricted Deque implementations; in most implementations, insert operations cannot fail.

Figure 9-2 reveals a table from Deque's Java documentation that nicely summarizes both forms of the insert, remove, and examine methods for both the head and the tail.

	First Element (Head)		Last Element (Tail)	
	<i>Throws exception</i>	<i>Special value</i>	<i>Throws exception</i>	<i>Special value</i>
<b>Insert</b>	<code>addFirst(e)</code>	<code>offerFirst(e)</code>	<code>addLast(e)</code>	<code>offerLast(e)</code>
<b>Remove</b>	<code>removeFirst()</code>	<code>pollFirst()</code>	<code>removeLast()</code>	<code>pollLast()</code>
<b>Examine</b>	<code>getFirst()</code>	<code>peekFirst()</code>	<code>getLast()</code>	<code>peekLast()</code>

**Figure 9-2.** Deque declares 12 methods for inserting, removing, and examining elements at the head or tail of a deque

When a deque is used as a queue, you observe FIFO behavior. Elements are added at the end of the deque and removed from the beginning. The methods inherited from the Queue interface are precisely equivalent to the Deque methods as indicated in Table 9-7.

**Table 9-7.** Queue and Equivalent Deque Methods

Queue Method	Equivalent Deque Method
<code>add(e)</code>	<code>addLast(e)</code>
<code>offer(e)</code>	<code>offerLast(e)</code>
<code>remove()</code>	<code>removeFirst()</code>
<code>poll()</code>	<code>pollFirst()</code>
<code>element()</code>	<code>getFirst()</code>
<code>peek()</code>	<code>peekFirst()</code>

Finally, deques can also be used as LIFO stacks. When a deque is used as a stack, elements are pushed and popped from the beginning of the deque. Because a stack's `push(e)` method would be equivalent to Deque's `addFirst(e)` method, its `pop()` method would be equivalent to Deque's `removeFirst()` method, and its `peek()` method would be equivalent to Deque's `peekFirst()` method, Deque declares the `E peek()`, `E pop()`, and `void push(E e)` stack-oriented convenience methods.

## ArrayDeque

The `ArrayDeque` class provides a resizable-array implementation of the `Deque` interface. It prohibits null elements from being added to a deque, and its `iterator()` method returns fail-fast iterators.

`ArrayDeque` supplies three constructors:

- `ArrayDeque()` creates an empty array deque with an initial capacity of 16 elements.
- `ArrayDeque(Collection<? extends E> c)` creates an array deque containing `c`'s elements in the order in which they are returned by `c`'s iterator. (The first element returned by `c`'s iterator becomes the first element or front of the deque.) `NullPointerException` is thrown when `c` contains the null reference.
- `ArrayDeque(int numElements)` creates an empty array deque with an initial capacity sufficient to hold `numElements` elements. No exception is thrown when the argument passed to `numElements` is less than or equal to zero.

Listing 9-16 demonstrates an array deque.

### *Listing 9-16. Using an Array Deque as a Stack*

```
import java.util.ArrayDeque;
import java.util.Deque;

public class ArrayDequeDemo
{
    public static void main(String[] args)
    {
        Deque<String> stack = new ArrayDeque<String>();
        String[] weekdays = { "Sunday", "Monday", "Tuesday", "Wednesday",
                               "Thursday", "Friday", "Saturday" };
        for (String weekday: weekdays)
            stack.push(weekday);
        while (stack.peek() != null)
            System.out.println(stack.pop());
    }
}
```

`ArrayDequeDemo` creates a deque for use as a stack and an array of weekday names. It then pushes these names on this stack and pops them, outputting the names in reverse order.

When you run this application, it generates the following output:

```
Saturday
Friday
Thursday
Wednesday
Tuesday
Monday
Sunday
```

## Exploring Maps

A *map* is a group of key/value pairs (also known as *entries*). Because the *key* identifies an entry, a map cannot contain duplicate keys. Furthermore, each key can map to at most one value. Maps are described by the `Map` interface, which has no parent interface, and whose generic type is `Map<K,V>` (K is the key's type; V is the value's type).

Table 9-8 describes `Map`'s methods.

**Table 9-8.** *Map Methods*

Method	Description
<code>void clear()</code>	Removes all elements from this map, leaving it empty. This method throws <code>UnsupportedOperationException</code> when <code>clear()</code> is not supported.
<code>boolean containsKey(Object key)</code>	Returns true when this map contains an entry for the specified key; otherwise, returns false. This method throws <code>ClassCastException</code> when key is of an inappropriate type for this map and <code>NullPointerException</code> when key contains the null reference and this map doesn't permit null keys.
<code>boolean containsValue(Object value)</code>	Returns true when this map maps one or more keys to value. This method throws <code>ClassCastException</code> when value is of an inappropriate type for this map and <code>NullPointerException</code> when value contains the null reference and this map doesn't permit null values.
<code>Set&lt;Map.Entry&lt;K,V&gt;&gt; entrySet()</code>	Returns a <code>Set</code> view of the entries contained in this map. Because this map backs the view, changes that are made to the map are reflected in the set and vice versa.
<code>boolean equals(Object o)</code>	Compares o with this map for equality. Returns true when o is also a map and the two maps represent the same entries; otherwise, returns false.
<code>V get(Object key)</code>	Returns the value to which key is mapped or null when this map contains no entry for key. If this map permits null values, then a return value of null doesn't necessarily indicate that the map contains no entry for key; it is also possible that the map explicitly maps key to the null reference. The <code>containsKey()</code> method may be used to distinguish between these two cases. This method throws <code>ClassCastException</code> when key is of an inappropriate type for this map and <code>NullPointerException</code> when key contains the null reference and this map doesn't permit null keys.
<code>int hashCode()</code>	Returns the hash code for this map. A map's hash code is defined to be the sum of the hash codes for the entries in the map's <code>entrySet()</code> view.
<code>boolean isEmpty()</code>	Returns true when this map contains no entries; otherwise, returns false.
<code>Set&lt;K&gt; keySet()</code>	Returns a <code>Set</code> view of the keys contained in this map. Because this map backs the view, changes that are made to the map are reflected in the set and vice versa.

(continued)

**Table 9-8.** (continued)

Method	Description
<code>V put(K key, V value)</code>	Associates value with key in this map. If the map previously contained an entry for key, the old value is replaced by value. This method returns the previous value associated with key or null when there was no entry for key. (The null return value can also indicate that the map previously associated the null reference with key, if the implementation supports null values.) This method throws <code>UnsupportedOperationException</code> when <code>put()</code> is not supported, <code>ClassCastException</code> when key's or value's class is not appropriate for this map, <code>IllegalArgumentException</code> when some property of key or value prevents it from being stored in this map, and <code>NullPointerException</code> when key or value contains the null reference and this map doesn't permit null keys or values.
<code>void putAll(Map&lt;? extends K, ? extends V&gt; m)</code>	Copies all entries from map m to this map. The effect of this call is equivalent to that of calling <code>put(k, v)</code> on this map once for each mapping from key k to value v in map m. This method throws <code>UnsupportedOperationException</code> when <code>putAll()</code> is not supported, <code>ClassCastException</code> when the class of a key or value in map m is not appropriate for this map, <code>IllegalArgumentException</code> when some property of a key or value in map m prevents it from being stored in this map, and <code>NullPointerException</code> when m contains the null reference or when m contains null keys or values and this map doesn't permit null keys or values.
<code>V remove(Object key)</code>	Removes key's entry from this map when it is present. This method returns the value to which this map previously associated with key or null when the map contained no mapping for key. If this map permits null values, then a return value of null doesn't necessarily indicate that the map contained no entry for key; it is also possible that the map explicitly mapped key to null. This map will not contain an entry for key once the call returns. This method throws <code>UnsupportedOperationException</code> when <code>remove()</code> is not supported, <code>ClassCastException</code> when the class of key is not appropriate for this map, and <code>NullPointerException</code> when key contains the null reference and this map doesn't permit null keys.
<code>int size()</code>	Returns the number of key/value entries in this map. If the map contains more than <code>Integer.MAX_VALUE</code> entries, this method returns <code>Integer.MAX_VALUE</code> .
<code>Collection&lt;V&gt; values()</code>	Returns a <code>Collection</code> view of the values contained in this map. Because this map backs the view, changes that are made to the map are reflected in the collection and vice versa.

Unlike List, Set, and Queue, Map doesn't extend Collection. However, it is possible to view a map as a Collection instance by calling Map's `keySet()`, `values()`, and `entrySet()` methods, which respectively return a Set of keys, a Collection of values, and a Set of key/value pair entries.

**Note** The `values()` method returns Collection instead of Set because multiple keys can map to the same value, and `values()` would then return multiple copies of the same value.

The Collection views returned by these methods (recall that a Set is a Collection because Set extends Collection) provide the only means to iterate over a Map. For example, suppose you declare Listing 9-17's Color enum with its three Color constants, RED, GREEN, and BLUE.

*Listing 9-17. A Colorful enum*

```
enum Color
{
    RED(255, 0, 0),
    GREEN(0, 255, 0),
    BLUE(0, 0, 255);

    private int r, g, b;

    private Color(int r, int g, int b)
    {
        this.r = r;
        this.g = g;
        this.b = b;
    }

    @Override
    public String toString()
    {
        return "r = " + r + ", g = " + g + ", b = " + b;
    }
}
```

The following example declares a map of String keys and Color values, adds several entries to the map, and iterates over the keys and values:

```
Map<String, Color> colorMap = ...; // ... represents the creation of a Map implementation
colorMap.put("red", Color.RED);
colorMap.put("blue", Color.BLUE);
colorMap.put("green", Color.GREEN);
colorMap.put("RED", Color.RED);
for (String colorKey: colorMap.keySet())
    System.out.println(colorKey);
Collection<Color> colorValues = colorMap.values();
for (Iterator<Color> it = colorValues.iterator(); it.hasNext();)
    System.out.println(it.next());
```



When running this code fragment against a hashmap implementation (discussed later) of `colorMap`, you should observe output similar to the following:

```
red
blue
green
RED
r = 255, g = 0, b = 0
r = 0, g = 0, b = 255
r = 0, g = 255, b = 0
r = 255, g = 0, b = 0
```

The first four output lines identify the map's keys; the second four output lines identify the map's values.

The `entrySet()` method returns a `Set` of `Map.Entry` objects. Each of these objects describes a single entry as a key/value pair and is an instance of a class that implements the `Map.Entry` interface, where `Entry` is a nested interface of `Map`. Table 9-9 describes `Map.Entry`'s methods.

**Table 9-9.** *Map.Entry Methods*

Method	Description
<code>boolean equals(Object o)</code>	Compares <code>o</code> with this entry for equality. Returns true when <code>o</code> is also a map entry and the two entries have the same key and value.
<code>K getKey()</code>	Returns this entry's key. This method optionally throws <code>IllegalStateException</code> when this entry has previously been removed from the backing map.
<code>V getValue()</code>	Returns this entry's value. This method optionally throws <code>IllegalStateException</code> when this entry has previously been removed from the backing map.
<code>int hashCode()</code>	Returns this entry's hash code.
<code>V setValue(V value)</code>	Replaces this entry's value with <code>value</code> . The backing map is updated with the new value. This method throws <code>UnsupportedOperationException</code> when <code>setValue()</code> is not supported, <code>ClassCastException</code> when <code>value</code> 's class prevents it from being stored in the backing map, <code>NullPointerException</code> when <code>value</code> contains the null reference and the backing map doesn't permit null, <code>IllegalArgumentException</code> when some property of <code>value</code> prevents it from being stored in the backing map, and (optionally) <code>IllegalStateException</code> when this entry has previously been removed from the backing map.

The following example shows you how you might iterate over the previous example's map entries:

```
for (Map.Entry<String, Color> colorEntry: colorMap.entrySet())
    System.out.println(colorEntry.getKey() + ": " + colorEntry.getValue());
```

When running this example against the previously mentioned hashmap implementation, you would observe the following output:

```
red: r = 255, g = 0, b = 0
blue: r = 0, g = 0, b = 255
green: r = 0, g = 255, b = 0
RED: r = 255, g = 0, b = 0
```

## TreeMap

The `TreeMap` class provides a map implementation that is based on a red-black tree. As a result, entries are stored in sorted order of their keys. However, accessing these entries is somewhat slower than with the other `Map` implementations (which are not sorted) because links must be traversed.

**Note** Check out Wikipedia's "Red-black tree" entry ([http://en.wikipedia.org/wiki/Red-black\\_tree](http://en.wikipedia.org/wiki/Red-black_tree)) to learn about red-black trees.

`TreeMap` supplies four constructors:

- `TreeMap()` creates a new, empty tree map that is sorted according to the natural ordering of its keys. All keys inserted into the map must implement the `Comparable` interface.
- `TreeMap(Comparator<? super K> comparator)` creates a new, empty tree map that is sorted according to the specified comparator. Passing `null` to `comparator` implies that natural ordering will be used.
- `TreeMap(Map<? extends K, ? extends V> m)` creates a new tree map containing `m`'s entries, sorted according to the natural ordering of its keys. All keys inserted into the new map must implement the `Comparable` interface. This constructor throws `ClassCastException` when `m`'s keys don't implement `Comparable` or are not mutually comparable and `NullPointerException` when `m` contains the null reference.
- `TreeMap(SortedMap<K, ? extends V> sm)` creates a new tree map containing the same entries and using the same ordering as `sm`. (I discuss sorted maps later in this chapter.) This constructor throws `NullPointerException` when `sm` contains the null reference.

Listing 9-18 demonstrates a tree map.

*Listing 9-18. Sorting a Map's Entries According to the Natural Ordering of Their String-Based Keys*

```
import java.util.Map;
import java.util.TreeMap;

public class TreeMapDemo
{
    public static void main(String[] args)
```

```

{
    Map<String, Integer> msi = new TreeMap<String, Integer>();
    String[] fruits = {"apples", "pears", "grapes", "bananas", "kiwis"};
    int[] quantities = {10, 15, 8, 17, 30};
    for (int i = 0; i < fruits.length; i++)
        msi.put(fruits[i], quantities[i]);
    for (Map.Entry<String, Integer> entry: msi.entrySet())
        System.out.println(entry.getKey() + ": " + entry.getValue());
}
}

```

`TreeMapDemo` creates a tree map and an array of fruit names. It then populates this map with these names and dumps the map's entries to standard output.

When you run this application, it generates the following output:

```

apples: 10
bananas: 17
grapes: 8
kiwis: 30
pears: 15

```

## HashMap

The `HashMap` class provides a map implementation that is based on a hashtable data structure. This implementation supports all `Map` operations and permits null keys and null values. It makes no guarantees on the order in which entries are stored.

A hashtable maps keys to integer values with the help of a *hash function*. Java provides this function in the form of `Object`'s `hashCode()` method, which classes override to provide appropriate hash codes.

A *hash code* identifies one of the hashtable's array elements, which is known as a *bucket* or *slot*. For some hashtables, the bucket may store the value that is associated with the key. Figure 9-3 illustrates this kind of hashtable.

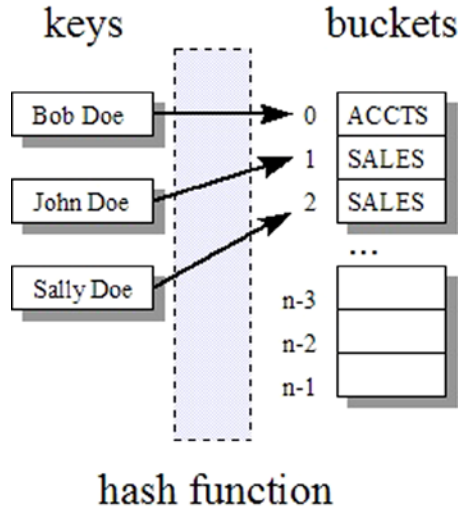
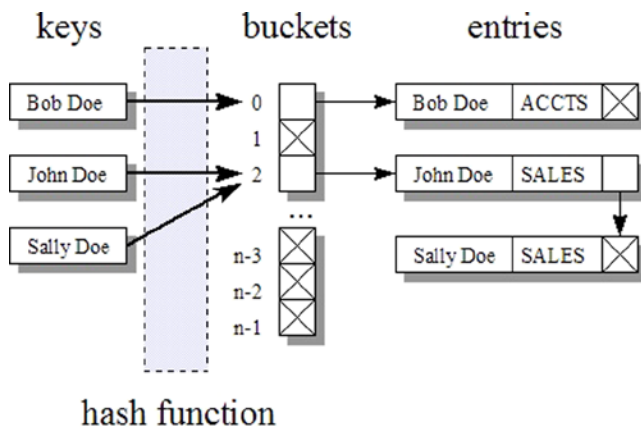

**Figure 9-3.** A simple hashtable maps keys to buckets that store values associated with those keys

The hash function hashes Bob Doe to 0, which identifies the first bucket. This bucket contains ACCTS, which is Bob Doe’s employee type. The hash function also hashes John Doe and Sally Doe to 1 and 2 (respectively) whose buckets contain SALES.

A perfect hash function hashes each key to a unique integer value. However, this ideal is very difficult to meet. In practice, some keys will hash to the same integer value. This nonunique mapping is referred to as a *collision*.

To address collisions, most hashtables associate a linked list of entries with a bucket. Instead of containing a value, the bucket contains the address of the first node in the linked list, and each node contains one of the colliding entries. See Figure 9-4.



**Figure 9-4.** A complex hashtable maps keys to buckets that store references to linked lists whose node values are hashed from the same keys

When storing a value in a hashtable, the hashtable uses the hash function to hash the key to its hash code, and then searches the appropriate linked list to see if an entry with a matching key exists. If there is an entry, its value is updated with the new value. Otherwise, a new node is created, populated with the key and value, and appended to the list.

When retrieving a value from a hashtable, the hashtable uses the hash function to hash the key to its hash code and then searches the appropriate linked list to see if an entry with a matching key exists. If there is an entry, its value is returned. Otherwise, the hashtable may return a special value to indicate that there is no entry, or it might throw an exception.

The number of buckets is known as the hashtable's *capacity*. The ratio of the number of stored entries divided by the number of buckets is known as the hashtable's *load factor*. Choosing the right load factor is important for balancing performance with memory use.

- As the load factor approaches 1, the probability of collisions and the cost of handling them (by searching lengthy linked lists) increase.
- As the load factor approaches 0, the hashtable's size in terms of number of buckets increases with little improvement in search cost.
- For many hashtables, a load factor of 0.75 is close to optimal. This value is the default for `HashMap`'s hashtable implementation.

`HashMap` supplies four constructors:

- `HashMap()` creates a new, empty hashmap with an initial capacity of 16 and a load factor of 0.75.
- `HashMap(int initialCapacity)` creates a new, empty hashmap with a capacity specified by `initialCapacity` and a load factor of 0.75. This constructor throws `IllegalArgumentException` when `initialCapacity`'s value is less than 0.
- `HashMap(int initialCapacity, float loadFactor)` creates a new, empty hashmap with a capacity specified by `initialCapacity` and a load factor specified by `loadFactor`. This constructor throws `IllegalArgumentException` when `initialCapacity` is less than 0 or when `loadFactor` is less than or equal to 0.
- `HashMap(Map<? extends K, ? extends V> m)` creates a new hashmap containing `m`'s entries. This constructor throws `NullPointerException` when `m` contains the null reference.

Listing 9-19 demonstrates a hashmap.

*Listing 9-19. Using a Hashmap to Count Command-Line Arguments*

```
import java.util.HashMap;
import java.util.Map;

public class HashMapDemo
{
    public static void main(String[] args)
    {
        Map<String, Integer> argMap = new HashMap<String, Integer>();
        for (String arg: args)
```

```

    {
        Integer count = argMap.get(arg);
        argMap.put(arg, (count == null) ? 1 : count + 1);
    }
    System.out.println(argMap);
    System.out.println("Number of distinct arguments = " + argMap.size());
}
}

```

HashMapDemo creates a hashmap of String keys and Integer values. Each key is one of the command-line arguments passed to this application, and its value is the number of occurrences of that argument on the command line.

For example, `java HashMapDemo how much wood could a woodchuck chuck if a woodchuck could chuck wood` generates the following output:

```

{wood=2, could=2, how=1, if=1, chuck=2, a=2, woodchuck=2, much=1}
Number of distinct arguments = 8

```

**Note** `LinkedHashMap` is a subclass of `HashMap` that uses a linked list to store its entries. As a result, `LinkedHashMap`'s iterator returns entries in the order in which they were inserted. For example, if Listing 9-19 had specified `Map<String, Integer> argMap = new LinkedHashMap<String, Integer>();`, the application's output for `java HashMapDemo how much wood could a woodchuck chuck if a woodchuck could chuck wood` would have been `{how=1, much=1, wood=2, could=2, a=2, woodchuck=2, chuck=2, if=1}` followed by `Number of distinct arguments = 8`.

## Overriding hashCode()

Because the `String` class overrides `equals()` and `hashCode()`, Listing 9-19 can use `String` objects as keys in a hashmap. When you create a class whose instances are to be used as keys, you must ensure that you override both methods.

Listing 9-6 showed you that a class's overriding `hashCode()` method can call a reference field's `hashCode()` method and return its value, provided that the class declares a single reference field (and no primitive-type fields).

More commonly, classes declare multiple fields, and a better implementation of the `hashCode()` method is required. The implementation should try to generate hash codes that minimize collisions.

There is no rule on how to best implement `hashCode()`, and various *algorithms* (recipes for accomplishing tasks) have been created. My favorite algorithm appears in *Effective Java, Second Edition*, by Joshua Bloch (Addison-Wesley, 2008; ISBN: 0321356683).

The following algorithm, which assumes the existence of an arbitrary class that is referred to as *X*, closely follows Bloch's algorithm, but is not identical:

1. Initialize `int` variable `hashCode` (the name is arbitrary) to an arbitrary nonzero integer value, such as 19. This variable is initialized to a nonzero value to ensure that it takes into account any initial fields whose hash codes are zeros. If you initialize `hashCode` to 0, the final hash code will be unaffected by such fields and you run the risk of increased collisions.
2. For each field *f* that is also used in *X*'s `equals()` method, calculate *f*'s hash code and assign it to `int` variable `hc` as follows:
  - a. If *f* is of `Boolean` type, calculate `hc = f ? 1 : 0`.
  - b. If *f* is of `byte` integer, `character`, `integer`, or `short` integer type, calculate `hc = (int) f`. The integer value is the hash code.
  - c. If *f* is of `long` integer type, calculate `hc = (int) (f ^ (f >>> 32))`. This expression exclusive ORs the long integer's least significant 32 bits with its most significant 32 bits.
  - d. If *f* is of type `floating-point`, calculate `hc = Float.floatToIntBits(f)`. This method takes `+infinity`, `-infinity`, and `NaN` into account.
  - e. If *f* is of type `double` precision `floating-point`, calculate `long l = Double.doubleToLongBits(f); hc = (int) (l ^ (l >>> 32))`.
  - f. If *f* is a reference field with a null reference, calculate `hc = 0`.
  - g. If *f* is a reference field with a nonnull reference, and if *X*'s `equals()` method compares the field by recursively calling `equals()` (as in Listing 9-12's `Employee` class), calculate `hc = f.hashCode()`. However, if `equals()` employs a more complex comparison, create a *canonical* (simplest possible) representation of the field and call `hashCode()` on this representation.
  - h. If *f* is an array, treat each element as a separate field by applying this algorithm recursively and combining the `hc` values as shown in the next step.
3. Combine `hc` with `hashCode` as follows: `hashCode = hashCode * 31 + hc`. Multiplying `hashCode` by 31 makes the resulting hash value dependent on the order in which fields appear in the class, which improves the hash value when a class contains multiple fields that are similar (several `ints`, for example). I chose 31 to be consistent with the `String` class's `hashCode()` method.
4. Return `hashCode` from `hashCode()`.

In Chapter 4, Listing 4-7's `Point` class overrode `equals()` but didn't override `hashCode()`. I later presented a small code fragment that must be appended to `Point`'s `main()` method to demonstrate the problem of not overriding `hashCode()`. I restate this problem here:

*Although objects `p1` and `Point(10, 20)` are logically equivalent, these objects have different hash codes, resulting in each object referring to a different entry in the hashmap. If an object is not stored (via `put()`) in that entry, `get()` returns null.*

Listing 9-20 modifies Listing 4-7's `Point` class by declaring a `hashCode()` method. This method uses the aforementioned algorithm to ensure that logically equivalent `Point` objects hash to the same entry.

*Listing 9-20. Overriding hashCode() to Return Proper Hash Codes for Point Objects*

```
import java.util.HashMap;
import java.util.Map;

public class Point
{
    private int x, y;

    Point(int x, int y)
    {
        this.x = x;
        this.y = y;
    }

    int getX()
    {
        return x;
    }

    int getY()
    {
        return y;
    }

    @Override
    public boolean equals(Object o)
    {
        if (!(o instanceof Point))
            return false;
        Point p = (Point) o;
        return p.x == x && p.y == y;
    }

    @Override
    public int hashCode()
    {
        int hashCode = 19;
        int hc = x;
        hashCode = hashCode * 31 + hc;
        hc = y;
        hashCode = hashCode * 31 + hc;
        return hashCode;
    }

    public static void main(String[] args)
    {
        Point p1 = new Point(10, 20);
        Point p2 = new Point(20, 30);
        Point p3 = new Point(10, 20);
    }
}
```



```

// Test reflexivity
System.out.println(p1.equals(p1));           // Output: true
// Test symmetry
System.out.println(p1.equals(p2));           // Output: false
System.out.println(p2.equals(p1));           // Output: false
// Test transitivity
System.out.println(p2.equals(p3));           // Output: false
System.out.println(p1.equals(p3));           // Output: true
// Test nullability
System.out.println(p1.equals(null));          // Output: false
// Extra test to further prove the instanceof operator's usefulness.
System.out.println(p1.equals("abc"));         // Output: false
Map<Point, String> map = new HashMap<Point, String>();
map.put(p1, "first point");
System.out.println(map.get(p1));              // Output: first point
System.out.println(map.get(new Point(10, 20))); // Output: first point
}
}

```

Listing 9-20's `hashCode()` method is a little verbose in that it assigns each of `x` and `y` to local variable `hc` rather than directly using these fields in the hash code calculation. However, I decided to follow this approach to more closely mirror the hash code algorithm.

When you run this application, its last two lines of output are of the most interest. Instead of presenting `first point` followed by `null` on two separate lines, the application now correctly presents `first point` followed by `first point` on these lines.

## HashMap and Image Caches

In Chapter 8, I introduced the `java.lang.ref.SoftReference` class and stated that this class is useful for implementing caches of objects. One kind of cache is an *image cache*, which keeps images in memory (because it takes time to load them from disk) and ensures that duplicate (and possibly very large) images are not stored in memory, which helps to avoid out-of-memory errors.

The image cache contains references to image objects that are already in memory. If these references were strong, the images would remain in memory. You would then need to figure out which images are no longer needed and remove them from memory so that they can be garbage collected.

Having to manually remove images duplicates the work of a garbage collector. However, when you wrap the references to the image objects in `SoftReference` objects, the garbage collector will determine when to remove these objects (typically when heap memory runs low) and perform the removal on your behalf.

Listing 9-21 presents a generic `SoftCache` class that combines `SoftReference` with the `HashMap` class to implement a cache of images (or another kind of objects).

*Listing 9-21. A Generic Class for Caching Arbitrary Objects in a HashMap*

```
import java.lang.ref.SoftReference;

import java.util.HashMap;

public class SoftCache<K, V>
{
    private HashMap<K, SoftReference<V>> map;

    public SoftCache()
    {
        map = new HashMap<K, SoftReference<V>>();
    }

    public V get(K key)
    {
        SoftReference<V> softRef = map.get(key);
        if (softRef == null)
            return null;
        return softRef.get();
    }

    public V put(K key, V value)
    {
        SoftReference<V> softRef = map.put(key, new SoftReference<V>(value));
        if (softRef == null)
            return null;
        V oldValue = softRef.get();
        softRef.clear();
        return oldValue;
    }

    public V remove(K key)
    {
        SoftReference<V> softRef = map.remove(key);
        if (softRef == null)
            return null;
        V oldValue = softRef.get();
        softRef.clear();
        return oldValue;
    }
}
```

Listing 9-21's `SoftCache` class is pretty straightforward. It declares a private `HashMap` field and initializes this field in its constructor. It also provides `get()`, `put()`, and `remove()` methods for interacting with the cache.

One item that might be confusing is the `softRef.clear()` method call in each of the `put()` and `remove()` methods. This call makes the previously stored referent (whose `SoftReference` container instance is being overwritten, in the case of `put()`, or removed, in the case of `remove()`), which is being returned from `put()` or `remove()`, eligible for cleanup. However, the value will not be cleaned

up when it's assigned to a variable, which would provide a strong reference to the value, and so it must be cleared.

Listing 9-22 presents an application that uses a `SoftCache` instance to cache (hypothetical) images, retrieve cached images before (hypothetically) drawing them, and re-cache images that are no longer cached.

*Listing 9-22. Caching Images*

```
import java.lang.ref.SoftReference;

class Image
{
    private byte[] image;

    private Image(String name)
    {
        image = new byte[1024 * 1024 * 100];
    }

    static Image getImage(String name)
    {
        return new Image(name);
    }
}

public class SoftCacheDemo
{
    public static void main(String[] args)
    {
        SoftCache<Integer, Image> sc = new SoftCache<Integer, Image>();
        int i = 0;
        while (true)
        {
            System.out.printf("Putting large image %d into soft cache%n", i);
            sc.put(i, Image.getImage("large.png" + i));
            i++;
            int x = (int) (Math.random() * i);
            System.out.printf("Acquiring image %d from cache.%n", x);
            Image im = sc.get(x);
            if (im == null)
            {
                System.out.printf("Image %d no longer in cache. Re-caching.%n", x);
                sc.put(x, im = Image.getImage("large.png" + x));
            }
            System.out.printf("Drawing image %d%n", x);
            im = null; // Remove strong reference to image.
        }
    }
}
```

Listing 9-22 declares an `Image` class that simulates the task of loading a large image, and declares a `SoftCacheDemo` class that demonstrates a `SoftCache` of `Image` objects.

The `main()` method first instantiates `SoftCache`. It then enters an infinite loop to continually cache new image objects and access image objects at random.

`SoftCache`'s `get()` method returns null when the image is no longer cached (or when no such image was ever put into the cache, which won't happen in this application). At this point, the image is re-obtained and re-cached via `SoftCache`'s `put()` method.

Compile Listing 9-22 (`javac SoftCacheDemo.java`) and run the application (`java SoftCacheDemo`). You should discover output that's similar to the following partial output (on a Windows 7 platform):

```
Acquiring image 6 from cache.
Image 6 no longer in cache. Re-caching.
Drawing image 6.
Putting large image 34 into soft cache.
Acquiring image 34 from cache.
Drawing image 34.
Putting large image 35 into soft cache.
Acquiring image 7 from cache.
Image 7 no longer in cache. Re-caching.
Drawing image 7.
Putting large image 36 into soft cache.
Acquiring image 1 from cache.
Image 1 no longer in cache. Re-caching.
Drawing image 1.
Putting large image 37 into soft cache.
Acquiring image 1 from cache.
Drawing image 1.
Putting large image 38 into soft cache.
Acquiring image 0 from cache.
Image 0 no longer in cache. Re-caching.
Drawing image 0.
Putting large image 39 into soft cache.
Acquiring image 34 from cache.
Image 34 no longer in cache. Re-caching.
Drawing image 34.
Putting large image 40 into soft cache.
Acquiring image 14 from cache.
Image 14 no longer in cache. Re-caching.
Drawing image 14.
Putting large image 41 into soft cache.
Acquiring image 38 from cache.
Drawing image 38.
Putting large image 42 into soft cache.
Acquiring image 39 from cache.
Drawing image 39.
Putting large image 43 into soft cache.
Acquiring image 27 from cache.
Image 27 no longer in cache. Re-caching.
Drawing image 27.
```

Putting large image 44 into soft cache.

**Acquiring image 34 from cache.**

**Drawing image 34.**

Putting large image 45 into soft cache.

## IdentityHashMap

The `IdentityHashMap` class provides a `Map` implementation that uses reference equality (`==`) instead of object equality (`equals()`) when comparing keys and values. This is an intentional violation of `Map`'s general contract, which mandates the use of `equals()` when comparing elements.

`IdentityHashMap` obtains hash codes via `System`'s `int identityHashCode(Object x)` class method instead of via each key's `hashCode()` method. `identityHashCode()` returns the same hash code for `x` as returned by `Object`'s `hashCode()` method, whether or not `x`'s class overrides `hashCode()`. The hash code for the null reference is zero.

These characteristics give `IdentityHashMap` a performance advantage over other `Map` implementations. Also, `IdentityHashMap` supports *mutable keys* (objects used as keys and whose hash codes change when their field values change while in the map). Listing 9-23 contrasts `IdentityHashMap` with `HashMap` where mutable keys are concerned.

*Listing 9-23. Contrasting IdentityHashMap with HashMap in a Mutable Key Context*

```
import java.util.IdentityHashMap;
import java.util.HashMap;
import java.util.Map;

public class IdentityHashMapDemo
{
    public static void main(String[] args)
    {
        Map<Employee, String> map1 = new IdentityHashMap<Employee, String>();
        Map<Employee, String> map2 = new HashMap<Employee, String>();
        Employee e1 = new Employee("John Doe", 28);
        map1.put(e1, "SALES");
        System.out.println(map1);
        Employee e2 = new Employee("Jane Doe", 26);
        map2.put(e2, "MGMT");
        System.out.println(map2);
        System.out.println("map1 contains key e1 = " + map1.containsKey(e1));
        System.out.println("map2 contains key e2 = " + map2.containsKey(e2));
        e1.setAge(29);
        e2.setAge(27);
        System.out.println(map1);
        System.out.println(map2);
        System.out.println("map1 contains key e1 = " + map1.containsKey(e1));
        System.out.println("map2 contains key e2 = " + map2.containsKey(e2));
    }
}
```

```
class Employee
{
    private String name;
    private int age;

    Employee(String name, int age)
    {
        this.name = name;
        this.age = age;
    }

    @Override
    public boolean equals(Object o)
    {
        if (!(o instanceof Employee))
            return false;
        Employee e = (Employee) o;
        return e.name.equals(name) && e.age == age;
    }

    @Override
    public int hashCode()
    {
        int hashCode = 19;
        hashCode = hashCode * 31 + name.hashCode();
        hashCode = hashCode * 31 + age;
        return hashCode;
    }

    void setAge(int age)
    {
        this.age = age;
    }

    void setName(String name)
    {
        this.name = name;
    }

    @Override
    public String toString()
    {
        return name + " " + age;
    }
}
```

Listing 9-23's `main()` method creates `IdentityHashMap` and `HashMap` instances that each store an entry consisting of an `Employee` key and a `String` value. Because `Employee` instances are mutable (because of `setAge()` and `setName()`), `main()` changes their ages while these keys are stored in their maps. These changes result in the following output:

```
{John Doe 28=SALES}
{Jane Doe 26=MGMT}
map1 contains key e1 = true
map2 contains key e2 = true
{John Doe 29=SALES}
{Jane Doe 27=MGMT}
map1 contains key e1 = true
map2 contains key e2 = false
```

The last four lines show that the changed entries remain in their maps. However, `map2`'s `containsKey()` method reports that its `HashMap` instance no longer contains its `Employee` key (which should be `Jane Doe 27`), whereas `map1`'s `containsKey()` method reports that its `IdentityHashMap` instance still contains its `Employee` key, which is now `John Doe 29`.

**Note** `IdentityHashMap`'s documentation states that “a typical use of this class is topology-preserving object graph transformations, such as serialization or deep copying.” (I discuss serialization in Chapter 11.) It also states that “another typical use of this class is to maintain proxy objects.” Also, [stackoverflow](http://stackoverflow.com/questions/838528/use-cases-for-identity-hashmap)'s “Use Cases for `IdentityHashMap`” topic (<http://stackoverflow.com/questions/838528/use-cases-for-identity-hashmap>) mentions that it is much faster to use `IdentityHashMap` than `HashMap` when the keys are `java.lang.Class` objects.

## WeakHashMap

The `WeakHashMap` class provides a `Map` implementation that's based on weakly reachable keys. Each key object is stored indirectly as the referent of a weak reference; and an entry is automatically removed from the map after the garbage collector clears all weak references to the entry's key.

**Note** Check out Chapter 8's “Exploring References” section to learn about weakly reachable and weak references.

`WeakHashMap` declares the same four constructors as `HashMap`. Listing 9-24 uses its noargument constructor to initialize a weak hashmap and detects when an entry is removed.

*Listing 9-24. Detecting a Weak Hashmap Entry's Removal*

```

import java.util.Map;
import java.util.WeakHashMap;

class LargeObject
{
    private byte[] memory = new byte[1024 * 1024 * 50]; // 50 megabytes
}

class WeakHashMapDemo
{
    public static void main(String[] args)
    {
        Map<LargeObject, String> map = new WeakHashMap<>();
        LargeObject lo = new LargeObject();
        map.put(lo, "Large Object");
        System.out.println(map);
        lo = null;
        while (!map.isEmpty())
        {
            System.out.println("looping until map is empty");
            new LargeObject();
        }
        System.out.println(map);
    }
}

```

Listing 9-24's `main()` method stores a 50MB `LargeObject` key and a `String` value in the weak hashmap and then removes the key's strong reference by assigning `null` to `lo`. `main()` next enters a while loop that executes until the map is empty (`map.isEmpty()` returns `true`).

The loop first outputs a message. It then creates a `LargeObject` object, throwing away its reference. This activity should eventually cause the garbage collector to run and remove the map's solitary entry. However, if you discover an unending loop, insert `System.gc();` into this loop. This method call hints to the virtual machine that now might be a good time to run the garbage collector.

Compile Listing 9-24 (`javac WeakReferenceDemo.java`) and run the application (`java WeakReferenceDemo`). You should discover output that's similar to the following Windows 7 output:

```

{LargeObject@6cc2060e=Large Object}
looping until map is empty
looping until map is empty
looping until map is empty
looping until map is empty
looping until map is empty
looping until map is empty
looping until map is empty
looping until map is empty
looping until map is empty
looping until map is empty
looping until map is empty
looping until map is empty
looping until map is empty
looping until map is empty

```





```

public class EnumMapDemo
{
    public static void main(String[] args)
    {
        Map<Coin, Integer> map = new EnumMap<Coin, Integer>(Coin.class);
        map.put(Coin.PENNY, 1);
        map.put(Coin.NICKEL, 5);
        map.put(Coin.DIME, 10);
        map.put(Coin.QUARTER, 25);
        System.out.println(map);
        Map<Coin,Integer> mapCopy = new EnumMap<Coin, Integer>(map);
        System.out.println(mapCopy);
    }
}

```

EnumMapDemo creates a map of Coin keys and Integer values. It then inserts several Coin instances into this map and outputs the map. Finally, it creates a copy of this map and outputs the copy.

When you run this application, it generates the following output:

```

{PENNY=1, NICKEL=5, DIME=10, QUARTER=25}
{PENNY=1, NICKEL=5, DIME=10, QUARTER=25}

```

## Exploring Sorted Maps

TreeMap is an example of a *sorted map*, which is a map that maintains its entries in ascending order, sorted according to the keys' natural ordering or according to a comparator that is supplied when the sorted map is created. Sorted maps are described by the SortedMap interface.

SortedMap (whose generic type is SortedMap<K, V>) extends Map. With two exceptions, the methods it inherits from Map behave identically on sorted maps as on other maps:

- The Iterator instance returned by the iterator() method on any of the sorted map's Collection views traverses the collections in order.
- The arrays returned by the Collection views' toArray() methods contain the keys, values, or entries in order.

**Note** Although not guaranteed, the toString() methods of the Collection views of SortedMap implementations in the Collections Framework (such as TreeMap) return a string containing all of the view's elements in order.

SortedMap's documentation requires that an implementation must provide the four standard constructors that I presented in my discussion of TreeMap. Furthermore, implementations of this interface must implement the methods that are described in Table 9-10.

**Table 9-10. SortedMap-Specific Methods**

Method	Description
<code>Comparator&lt;? super K&gt; comparator()</code>	Returns the comparator used to order the keys in this map, or null when this map uses the natural ordering of its keys.
<code>Set&lt;Map.Entry&lt;K,V&gt;&gt; entrySet()</code>	Returns a Set view of the mappings contained in this map. The set's iterator returns these entries in ascending key order. Because the view is backed by this map, changes that are made to the map are reflected in the set and vice versa.
<code>K firstKey()</code>	Returns the first (lowest) key currently in this map, or throws a <code>NoSuchElementException</code> instance when this map is empty.
<code>SortedMap&lt;K, V&gt; headMap(K toKey)</code>	Returns a view of that portion of this map whose keys are strictly less than <code>toKey</code> . Because this map backs the returned map, changes in the returned map are reflected in this map and vice versa. The returned map supports all optional map operations that this map supports. This method throws <code>ClassCastException</code> when <code>toKey</code> is not compatible with this map's comparator (or, when the map has no comparator, when <code>toKey</code> doesn't implement <code>Comparable</code> ), <code>NullPointerException</code> when <code>toKey</code> is null and this map doesn't permit null keys, and <code>IllegalArgumentException</code> when this map has a restricted range and <code>toKey</code> lies outside of this range's bounds.
<code>Set&lt;K&gt; keySet()</code>	Returns a Set view of the keys contained in this map. The set's iterator returns the keys in ascending order. Because the map backs the view, changes that are made to the map are reflected in the set and vice versa.
<code>K lastKey()</code>	Returns the last (highest) key currently in this map, or throws a <code>NoSuchElementException</code> instance when this map is empty.
<code>SortedMap&lt;K, V&gt; subMap(K fromKey, K toKey)</code>	Returns a view of the portion of this map whose keys range from <code>fromKey</code> , inclusive, to <code>toKey</code> , exclusive. (When <code>fromKey</code> and <code>toKey</code> are equal, the returned map is empty.) Because this map backs the returned map, changes in the returned map are reflected in this map and vice versa. The returned map supports all optional map operations that this map supports. This method throws <code>ClassCastException</code> when <code>fromKey</code> and <code>toKey</code> cannot be compared to one another using this map's comparator (or, when the map has no comparator, using natural ordering), <code>NullPointerException</code> when <code>fromKey</code> or <code>toKey</code> is null and this map doesn't permit null keys, and <code>IllegalArgumentException</code> when <code>fromKey</code> is greater than <code>toKey</code> or when this map has a restricted range and <code>fromKey</code> or <code>toKey</code> lies outside of this range's bounds.

*(continued)*

**Table 9-10.** (continued)

Method	Description
SortedMap<K, V> tailMap(K fromKey)	Returns a view of that portion of this map whose keys are greater than or equal to fromKey. Because this map backs the returned map, changes in the returned map are reflected in this map and vice versa. The returned map supports all optional map operations that this map supports. This method throws <code>ClassCastException</code> when fromKey is not compatible with this map's comparator (or, when the map has no comparator, when fromKey doesn't implement <code>Comparable</code> ), <code>NullPointerException</code> when fromKey is null and this map doesn't permit null elements, and <code>IllegalArgumentException</code> when this map has a restricted range and fromKey lies outside of the range's bounds.
Collection<V> values()	Returns a <code>Collection</code> view of the values contained in this map. The collection's iterator returns the values in ascending order of the corresponding keys. Because the map backs the collection, changes that are made to the map are reflected in the collection and vice versa.

Listing 9-26 demonstrates a sorted map based on a tree map.

*Listing 9-26. A Sorted Map of Office Supply Names and Quantities*

```
import java.util.Comparator;
import java.util.SortedMap;
import java.util.TreeMap;

public class SortedMapDemo
{
    public static void main(String[] args)
    {
        SortedMap<String, Integer> smsi = new TreeMap<String, Integer>();
        String[] officeSupplies =
        {
            "pen", "pencil", "legal pad", "CD", "paper"
        };
        int[] quantities =
        {
            20, 30, 5, 10, 20
        };
        for (int i = 0; i < officeSupplies.length; i++)
            smsi.put(officeSupplies[i], quantities[i]);
        System.out.println(smsi);
        System.out.println(smsi.headMap("pencil"));
        System.out.println(smsi.headMap("paper"));
        SortedMap<String, Integer> smsiCopy;
```

```

Comparator<String> cmp;
cmp = new Comparator<String>()
    {
        @Override
        public int compare(String key1, String key2)
        {
            return key2.compareTo(key1); // descending order
        }
    };
smsiCopy = new TreeMap<String, Integer>(cmp);
smsiCopy.putAll(smsi);
System.out.println(smsiCopy);
}
}

```

SortedMapDemo creates a sorted map and arrays of office supply names and quantities. It then proceeds to populate the map from these arrays. After dumping out the map's contents and head views of parts of the map, it creates and outputs a copy of the map in descending order.

When you run this application, it generates the following output:

```

{CD=10, legal pad=5, paper=20, pen=20, pencil=30}
{CD=10, legal pad=5, paper=20, pen=20}
{CD=10, legal pad=5}
{pencil=30, pen=20, paper=20, legal pad=5, CD=10}

```

## Exploring Navigable Maps

TreeMap is an example of a *navigable map*, which is a sorted map that can be iterated over in descending order as well as ascending order and which can report closest matches for given search targets. Navigable maps are described by the NavigableMap interface, whose generic type is NavigableMap<K,V>, which extends SortedMap, and which is described in Table 9-11.

**Table 9-11.** *NavigableMap-Specific Methods*

Method	Description
Map.Entry<K,V> ceilingEntry(K key)	Returns the key-value mapping associated with the least key greater than or equal to key, or null when there is no such key. This method throws <code>ClassCastException</code> when key cannot be compared with the keys currently in the map and <code>NullPointerException</code> when key is null and this map doesn't permit null keys.
K ceilingKey(K key)	Returns the least key greater than or equal to key, or null when there is no such key. This method throws <code>ClassCastException</code> when key cannot be compared with the keys currently in the map, and <code>NullPointerException</code> when key is null and this map doesn't permit null keys.
NavigableSet<K> descendingKeySet()	Returns a reverse order navigable set-based view of the keys contained in this map. The set's iterator returns the keys in descending order. This map backs the set, so changes to the map are reflected in the set and vice versa. If the map is modified (except through the iterator's own <code>remove()</code> operation) while iterating over the set, the results of the iteration are undefined.
NavigableMap<K,V> descendingMap()	Returns a reverse order view of the mappings contained in this map. This map backs the descending map, so changes to the map are reflected in the descending map and vice versa. If either map is modified while iterating over a collection view of either map (except through the iterator's own <code>remove()</code> operation), the results of the iteration are undefined.
Map.Entry<K,V> firstEntry()	Returns a key-value mapping associated with the least key in this map or null when the map is empty.
Map.Entry<K,V> floorEntry(K key)	Returns a key-value mapping associated with the greatest key less than or equal to key or null when there is no such key. This method throws <code>ClassCastException</code> when key cannot be compared with the keys currently in the map and <code>NullPointerException</code> when key is null and this map doesn't permit null keys.
K floorKey(K key)	Returns the greatest key less than or equal to key or null when there is no such key. This method throws <code>ClassCastException</code> when key cannot be compared with the keys currently in the map and <code>NullPointerException</code> when key is null and this map doesn't permit null keys.
NavigableMap<K,V> headMap(K toKey, boolean inclusive)	Returns a view of the portion of this map whose keys are less than (or equal to, when <code>inclusive</code> is true) <code>toKey</code> . This map backs the returned map, so changes in the returned map are reflected in this map and vice versa. The returned map supports all optional map operations that this map supports. This method throws <code>ClassCastException</code> when <code>toKey</code> is not compatible with this map's comparator (or, when the map has no comparator, when <code>toMap</code> doesn't implement <code>Comparable</code> ), <code>NullPointerException</code> when <code>toKey</code> is null and this map doesn't permit null keys, and <code>IllegalArgumentException</code> when this map has a restricted range and <code>toKey</code> lies outside of this range's bounds.

*(continued)*

Table 9-11. (continued)

Method	Description
Map.Entry<K,V> higherEntry(K key)	Returns a key-value mapping associated with the least key strictly greater than key, or null when there is no such key. This method throws <code>ClassCastException</code> when key cannot be compared with the keys currently in the map and <code>NullPointerException</code> when key is null and this map doesn't permit null keys.
K higherKey(K key)	Returns the least key strictly greater than key, or null when there is no such key. This method throws <code>ClassCastException</code> when key cannot be compared with the keys currently in the map and <code>NullPointerException</code> when key is null and this map doesn't permit null keys.
Map.Entry<K,V> lastEntry()	Returns a key-value mapping associated with the greatest key in this map, or null when the map is empty.
Map.Entry<K,V> lowerEntry(K key)	Returns a key-value mapping associated with the greatest key strictly less than key, or null when there is no such key. This method throws <code>ClassCastException</code> when key cannot be compared with the keys currently in the map and <code>NullPointerException</code> when key is null and this map doesn't permit null keys.
K lowerKey(K key)	Returns the greatest key strictly less than key, or null when there is no such key. This method throws <code>ClassCastException</code> when key cannot be compared with the keys currently in the map and <code>NullPointerException</code> when key is null and this map doesn't permit null keys.
NavigableSet<K> navigableKeySet()	Returns a navigable set-based view of the keys contained in this map. The set's iterator returns the keys in ascending order. This map backs the set, so changes to the map are reflected in the set and vice versa. If the map is modified while iterating over the set (except through the iterator's own <code>remove()</code> operation), the results of the iteration are undefined.
Map.Entry<K,V> pollFirstEntry()	Removes and returns a key-value mapping associated with the least key in this map, or null when the map is empty.
Map.Entry<K,V> pollLastEntry()	Removes and returns a key-value mapping associated with the greatest key in this map, or null when the map is empty.
NavigableMap<K,V> subMap(K fromKey, boolean fromInclusive, K toKey, boolean toInclusive)	Returns a view of the portion of this map whose keys range from <code>fromKey</code> to <code>toKey</code> . (When <code>fromKey</code> and <code>toKey</code> are equal, the returned map is empty unless <code>fromInclusive</code> and <code>toInclusive</code> are both true.) This map backs the returned map, so changes in the returned map are reflected in this map and vice versa. The returned map supports all optional map operations that this map supports. This method throws <code>ClassCastException</code> when <code>fromKey</code> and <code>toKey</code> cannot be compared to one another using this map's comparator (or, when the map has no comparator, using natural ordering), <code>NullPointerException</code> when <code>fromKey</code> or <code>toKey</code> is null and this map doesn't permit null elements, and <code>IllegalArgumentException</code> when <code>fromKey</code> is greater than <code>toKey</code> or when this map has a restricted range and <code>fromKey</code> or <code>toKey</code> lies outside of this range's bounds.

(continued)

Table 9-11. (continued)

Method	Description
<code>NavigableMap&lt;K,V&gt; tailMap(K fromKey, boolean inclusive)</code>	Returns a view of the portion of this map whose keys are greater than (or equal to, when inclusive is true) fromKey. This map backs the returned map, so changes in the returned map are reflected in this map and vice versa. The returned map supports all optional map operations that this map supports. This method throws <code>ClassCastException</code> when fromKey is not compatible with this map's comparator (or, when the map has no comparator, when fromKey doesn't implement <code>Comparable</code> ), <code>NullPointerException</code> when fromKey is null and this map doesn't permit null keys, and <code>IllegalArgumentException</code> when this map has a restricted range and fromKey lies outside of this range's bounds.

Table 9-11's methods describe the `NavigableMap` equivalents of the `NavigableSet` methods presented in Table 9-4 and even return `NavigableSet` instances in two instances.

Listing 9-27 demonstrates a navigable map based on a tree map.

Listing 9-27. Navigating a Map of (Bird, Count within A Small Acreage) Entries

```
import java.util.Iterator;
import java.util.NavigableMap;
import java.util.NavigableSet;
import java.util.TreeMap;

public class NavigableMapDemo
{
    public static void main(String[] args)
    {
        NavigableMap<String, Integer> nm = new TreeMap<String, Integer>();
        String[] birds = { "sparrow", "bluejay", "robin" };
        int[] ints = { 83, 12, 19 };
        for (int i = 0; i < birds.length; i++)
            nm.put(birds[i], ints[i]);
        System.out.println("Map = " + nm);
        System.out.print("Ascending order of keys: ");
        NavigableSet<String> ns = nm.navigableKeySet();
        Iterator iter = ns.iterator();
        while (iter.hasNext())
            System.out.print(iter.next() + " ");
        System.out.println();
        System.out.print("Descending order of keys: ");
        ns = nm.descendingKeySet();
        iter = ns.iterator();
        while (iter.hasNext())
            System.out.print(iter.next() + " ");
        System.out.println();
        System.out.println("First entry = " + nm.firstEntry());
        System.out.println("Last entry = " + nm.lastEntry());
        System.out.println("Entry < ostrich is " + nm.lowerEntry("ostrich"));
    }
}
```



```

        System.out.println("Entry > crow is " + nm.higherEntry("crow"));
        System.out.println("Poll first entry: " + nm.pollFirstEntry());
        System.out.println("Map = " + nm);
        System.out.println("Poll last entry: " + nm.pollLastEntry());
        System.out.println("Map = " + nm);
    }
}

```

Listing 9-27's `System.out.println("Map = " + nm);` method calls rely on `TreeMap`'s `toString()` method to obtain the contents of a navigable map.

When you run this application, you will observe the following output:

```

Map = {bluejay=12, robin=19, sparrow=83}
Ascending order of keys: bluejay robin sparrow
Descending order of keys: sparrow robin bluejay
First entry = bluejay=12
Last entry = sparrow=83
Entry < ostrich is bluejay=12
Entry > crow is robin=19
Poll first entry: bluejay=12
Map = {robin=19, sparrow=83}
Poll last entry: sparrow=83
Map = {robin=19}

```

## Exploring the Arrays and Collections Utility APIs

The Collections Framework would be incomplete without its `Arrays` and `Collections` utility classes. Each class supplies various class methods that implement useful algorithms in the contexts of collections and arrays.

The following is a sampling of the `Arrays` class's array-oriented utility methods:

- `static <T> List<T> asList(T... a)` returns a fixed-size list backed by array `a`. (Changes to the returned list “write through” to the array.) For example, `List<String> birds = Arrays.asList("Robin", "Oriole", "Bluejay");` converts the three-element array of `Strings` (recall that a variable sequence of arguments is implemented as an array) to a `List` whose reference is assigned to `birds`.
- `static int binarySearch(int[] a, int key)` searches array `a` for entry `key` using the Binary Search algorithm (explained following this list). The array must be sorted before calling this method; otherwise, the results are undefined. This method returns the index of the search key, if it is contained in the array; otherwise, `-(insertion point) - 1` is returned. The insertion point is the point at which `key` would be inserted into the array (the index of the first element greater than `key`, or `a.length` if all elements in the array are less than `key`) and guarantees that the return value will be greater than or equal to 0 if and only if `key` is found. For example, `Arrays.binarySearch(new String[] { "Robin", "Oriole", "Bluejay"}, "Oriole")` returns 1, “Oriole”'s index.

- `static void fill(char[] a, char ch)` stores `ch` in each element of the specified character array. For example, `Arrays.fill(screen[i], ' ');` fills the `i`th row of a 2D `screen` array with spaces.
- `static void sort(long[] a)` sorts the elements in the long integer array `a` into ascending numerical order, for example, `long lArray = new long[] { 20000L, 89L, 66L, 33L}; Arrays.sort(lArray);`.
- `static <T> void sort(T[] a, Comparator<? super T> c)` sorts the elements in array `a` using comparator `c` to order them. For example, when given `Comparator<String> cmp = new Comparator<String>() { @Override public int compare(String e1, String e2) { return e2.compareTo(e1); } }; String[] innerPlanets = { "Mercury", "Venus", "Earth", "Mars" }; Arrays.sort(innerPlanets, cmp);` uses `cmp` to help in sorting `innerPlanets` into descending order of its elements: Venus, Mercury, Mars, Earth is the result.

There are two common algorithms for searching an array for a specific element. *Linear Search* searches the array element by element from index 0 to the index of the searched-for element or the end of the array. On average, half of the elements must be searched; larger arrays take longer to search. However, the arrays don't need to be sorted.

In contrast, *Binary Search* searches ordered array `a`'s `n` items for element `e` in a much faster amount of time. It works by recursively performing the following steps:

1. Set low index to 0.
2. Set high index to  $n - 1$ .
3. If low index > high index, then Print "Unable to find " `e`. End.
4. Set `e` to `a[middle index]`.
5. Set middle index to  $(\text{low index} + \text{high index}) / 2$ .
6. If `e > a[middle index]`, then set low index to middle index + 1. Go to 3.
7. If `e < a[middle index]`, then set high index to middle index - 1. Go to 3.
8. Print "Found " `e` "at index " middle index.

The algorithm is similar to optimally looking for a name in a phone book. Start by opening the book to the exact middle. If the name is not on that page, proceed to open the book to the exact middle of the first half or the second half, depending on which half the name occurs in. Repeat until you find the name (or not).

Applying a linear search to 4,000,000,000 elements results in approximately 2,000,000,000 comparisons (on average), which takes time. In contrast, applying a binary search to 4,000,000,000 elements performs a maximum of 32 comparisons. This is why `Arrays` contains `binarySearch()` methods and not also `linearSearch()` methods.

Following is a sampling of the Collections class's collection-oriented class methods:

- `static <T extends Object & Comparable<? super T>> T min(Collection<? extends T> c)` returns the minimum element of collection `c` according to the natural ordering of its elements. For example, `System.out.println(Collections.min(Arrays.asList(10, 3, 18, 25)));` outputs 3. All of `c`'s elements must implement the `Comparable` interface. Furthermore, all elements must be mutually comparable. This method throws `NoSuchElementException` when `c` is empty.
- `static void reverse(List<?> l)` reverses the order of list `l`'s elements. For example, `List<String> birds = Arrays.asList("Robin", "Oriole", "Bluejay"); Collections.reverse(birds); System.out.println(birds);` results in `[Bluejay, Oriole, Robin]` as the output.
- `static <T> List<T> singletonList(T o)` returns an immutable list containing only object `o`. For example, `list.removeAll(Collections.singletonList(null));` removes all null elements from list.
- `static <T> Set<T> synchronizedSet(Set<T> s)` returns a synchronized (thread-safe) set backed by the specified set `s`, for example, `Set<String> ss = Collections.synchronizedSet(new HashSet<String>());`. To guarantee serial access, it's critical that all access to the backing set (`s`) is accomplished through the returned set.
- `static <K,V> Map<K,V> unmodifiableMap(Map<? extends K,? extends V> m)` returns an unmodifiable view of map `m`, for example, `Map<String, Integer> msi = Collections.unmodifiableMap(new HashMap<String, Integer>());`. Query operations on the returned map “read through” to the specified map; and attempts to modify the returned map, whether direct or via its collection views, result in an `UnsupportedOperationException`.

**Note** For performance reasons, collections implementations are unsynchronized—unsynchronized collections have better performance than synchronized collections. To use a collection in a multithreaded context, however, you need to obtain a synchronized version of that collection. You obtain that version by calling a synchronized-prefixed method such as `synchronizedSet()`.

You might be wondering about the purpose for the various “empty” class methods in the Collections class. For example, `static final <T> List<T> emptyList()` returns an immutable empty list, as in `List<String> ls = Collections.emptyList();`. These methods are present because they offer a useful alternative to returning null (and avoiding potential `NullPointerExceptions`) in certain contexts. Consider Listing 9-28.

*Listing 9-28. Empty and Nonempty Lists of Birds*

```
import java.util.ArrayList;
import java.util.Collections;
import java.util.Iterator;
import java.util.List;

class Birds
{
    private List<String> birds;

    Birds()
    {
        birds = Collections.emptyList();
    }

    Birds(String... birdNames)
    {
        birds = new ArrayList<String>();
        for (String birdName: birdNames)
            birds.add(birdName);
    }

    @Override
    public String toString()
    {
        return birds.toString();
    }
}

class EmptyListDemo
{
    public static void main(String[] args)
    {
        Birds birds = new Birds();
        System.out.println(birds);
        birds = new Birds("Swallow", "Robin", "Bluejay", "Oriole");
        System.out.println(birds);
    }
}
```

Listing 9-28 declares a `Birds` class that stores the names of various birds in a list. This class provides two constructors: a noargument constructor and a constructor that takes a variable number of `String` arguments identifying various birds.

The noargument constructor invokes `emptyList()` to initialize its private `birds` field to an empty `List` of `String`—`emptyList()` is a generic method and the compiler infers its return type from its context.

If you're wondering about the need for `emptyList()`, look at the `toString()` method. Notice that this method evaluates `birds.toString()`. If you didn't assign a reference to an empty `List<String>` to `birds`, `birds` would contain the null reference (the default value for this instance field when the object is created), and a `NullPointerException` instance would be thrown when attempting to evaluate `birds.toString()`.

When you run this application (`java EmptyListDemo`), it generates the following output:

```
[]
[Swallow, Robin, Bluejay, Oriole]
```

The `emptyList()` method is implemented as follows: `return (List<T>) EMPTY_LIST;`. This statement returns the single `List` instance assigned to the `EMPTY_LIST` class field in the `Collections` class.

You might want to work with `EMPTY_LIST` directly, but you'll run into an unchecked warning message if you do, because `EMPTY_LIST` is declared to be of the raw type `List`, and mixing raw and generic types leads to such messages. Although you could suppress the warning, you're better off using the `emptyList()` method.

Suppose you add a `void setBirds(List<String> birds)` method to `Birds` and pass an empty list to this method, as in `birds.setBirds(Collections.emptyList());`. The compiler will respond with an error message stating that it requires the argument to be of type `List<String>`, but instead the argument is of type `List<Object>`. It does so because the compiler cannot figure out the proper type from this context, and so it chooses `List<Object>`.

This problem can be solved by explicitly specifying the type argument. Specify `birds.setBirds(Collections.<String>emptyList());`, where the formal type parameter `list` and its type argument appear after the member access operator and before the method name. The compiler will now know that the proper type argument is `String` and that `emptyList()` is to return `List<String>`.

## Exploring the Legacy Collection APIs

Java 1.2 introduced the Collections Framework. Before the framework's inclusion in Java, developers had two choices where collections were concerned: create their own frameworks, or use the `Vector`, `Enumeration`, `Stack`, `Dictionary`, `Hashtable`, `Properties`, and `BitSet` types, which were introduced by Java 1.0.

`Vector` is a concrete class that describes a growable array, much like `ArrayList`. Unlike an `ArrayList` instance, a `Vector` instance is synchronized. `Vector` has been generified and also retrofitted to support the Collections Framework, which makes statements such as `List<String> list = new Vector<String>();` legal. You may need to perform similar assignments when working with legacy code that depends on `Vector`.

The Collections Framework provides `Iterator` for iterating over a collection's elements. In contrast, `Vector`'s `elements()` method returns an instance of a class that implements the `Enumeration` interface for *enumerating* (iterating over and returning) a `Vector` instance's elements via `Enumeration`'s `hasMoreElements()` and `nextElement()` methods. Consider the following example:

```
Enumeration e = vector.elements();
while (e.hasMoreElements())
    System.out.println(e.nextElement());
```

`Vector` is subclassed by the concrete `Stack` class, which represents a LIFO data structure. `Stack` provides an `E push(E item)` method for pushing an object onto the stack, an `E pop()` method for popping an item off the top of the stack, and a few other methods, such as `boolean empty()` for determining whether or not the stack is empty.

Stack is a good example of bad API design. By inheriting from Vector, it's possible to call Vector's void add(int index, E element) method to add an element anywhere you wish and violate a Stack instance's integrity. In hindsight, Stack should have used composition in its design: use a Vector instance to store a Stack instance's elements.

Dictionary is an abstract superclass for subclasses that map keys to values. The concrete Hashtable class is Dictionary's only subclass. As with Vector, Hashtable instances are synchronized, Hashtable has been generified, and Hashtable has been retrofitted to support the Collections Framework.

Hashtable is subclassed by Properties, a concrete class representing a persistent set of *properties* (String-based key/value pairs that identify application settings). Properties provides Object setProperty(String key, String value) for storing a property and String getProperty(String key) for returning a property's value.

**Note** Applications use properties for various purposes. For example, if your application has a graphical user interface, you could store the screen location and size of its main window in a file via a Properties object so that the application can restore the window's location and size when it next runs.

Properties is another good example of bad API design. By inheriting from Hashtable, you can call Hashtable's V put(K key, V value) method to store an entry with a non-String key and/or a non-String value. In hindsight, Properties should have leveraged composition: store a Properties instance's elements in a Hashtable instance.

**Note** Chapter 4 discussed wrapper classes, which is how Stack and Properties should have been implemented.

Finally, BitSet is a concrete class that describes a variable-length set of bits. This class's ability to represent bitsets of arbitrary length contrasts with the previously described integer-based, fixed-length bitset that is limited to a maximum number of members: 32 members for an int-based bitset, or 64 members for a long-based bitset.

BitSet provides a pair of constructors for initializing a BitSet instance: BitSet() initializes the instance to initially store an implementation-dependent number of bits, whereas BitSet(int nbits) initializes the instance to initially store nbits bits. BitSet also provides various methods, including the following:

- void and(BitSet bs) bitwise ANDs this bitset with bs. This bitset is modified such that a bit is set to 1 when it and the bit at the same position in bs are 1.
- void andNot(BitSet bs) sets all of the bits in this bitset to 0 whose corresponding bits are set to 1 in bs.
- void clear() sets all of the bits in this bitset to 0.

- Object `clone()` clones this bitset to produce a new bitset. The clone has exactly the same bits set to one as this bitset.
- boolean `get(int bitIndex)` returns the value of this bitset's bit as a Boolean true/false value (true for 1, false for 0) at the zero-based `bitIndex`. This method throws `IndexOutOfBoundsException` when `bitIndex` is less than 0.
- int `length()` returns the “logical size” of this bitset, which is the index of the highest 1 bit plus 1, or 0 if this bitset contains no 1 bits.
- void `or(BitSet bs)` bitwise inclusive ORs this bitset with `bs`. This bitset is modified such that a bit is set to 1 when it or the bit at the same position in `bs` is 1 or when both bits are 1.
- void `set(int bitIndex, boolean value)` sets the bit at the zero-based `bitIndex` to `value` (true is converted to 1; false is converted to 0). This method throws `IndexOutOfBoundsException` when `bitIndex` is less than 0.
- int `size()` returns the number of bits that are being used by this bitset to represent bit values.
- String `toString()` returns a string representation of this bitset in terms of the positions of bits that are 1, for example, {4, 5, 9, 10}.
- void `xor(BitSet set)` bitwise exclusive ORs this bitset with `bs`. This bitset is modified such that a bit is set to 1 when either it or the bit at the same position in `bs` (but not both) is 1.

Listing 9-29 presents an application that demonstrates some of these methods and gives you more insight into how the bitwise AND (&), bitwise inclusive OR (|), and bitwise exclusive OR (^) operators work.

*Listing 9-29. Working with Variable-Length Bitsets*

```
import java.util.BitSet;

public class BitSetDemo
{
    public static void main(String[] args)
    {
        BitSet bs1 = new BitSet();
        bs1.set(4, true);
        bs1.set(5, true);
        bs1.set(9, true);
        bs1.set(10, true);
        BitSet bsTemp = (BitSet) bs1.clone();
        dumpBitset("          ", bs1);
        BitSet bs2 = new BitSet();
        bs2.set(4, true);
        bs2.set(6, true);
        bs2.set(7, true);
        bs2.set(9, true);
        dumpBitset("          ", bs2);
        bs1.and(bs2);
    }
}
```

```

    dumpSeparator(Math.min(bs1.size(), 16));
    dumpBitset("AND (&) ", bs1);
    System.out.println();
    bs1 = bsTemp;
    dumpBitset("      ", bs1);
    dumpBitset("      ", bs2);
    bsTemp = (BitSet) bs1.clone();
    bs1.or(bs2);
    dumpSeparator(Math.min(bs1.size(), 16));
    dumpBitset("OR (|) ", bs1);
    System.out.println();
    bs1 = bsTemp;
    dumpBitset("      ", bs1);
    dumpBitset("      ", bs2);
    bsTemp = (BitSet) bs1.clone();
    bs1.xor(bs2);
    dumpSeparator(Math.min(bs1.size(), 16));
    dumpBitset("XOR (^) ", bs1);
}

static void dumpBitset(String preamble, BitSet bs)
{
    System.out.print(preamble);
    int size = Math.min(bs.size(), 16);
    for (int i = 0; i < size; i++)
        System.out.print(bs.get(i) ? "1" : "0");
    System.out.print(" size(" + bs.size() + "), length(" + bs.length() + ")");
    System.out.println();
}

static void dumpSeparator(int len)
{
    System.out.print("      ");
    for (int i = 0; i < len; i++)
        System.out.print("-");
    System.out.println();
}
}

```

Why did I specify `Math.min(bs.size(), 16)` in `dumpBitset()` and pass a similar expression to `dumpSeparator()`? I wanted to display exactly 16 bits and 16 dashes (for aesthetics), and needed to account for a bitset's size being less than 16. Although this doesn't happen with Oracle's and Google's `BitSet` classes, it might happen with some other variant.

When you run this application, it generates the following output:

```

    0000110001100000 size(64), length(11)
    0000101101000000 size(64), length(10)
    -----
AND (&) 0000100001000000 size(64), length(10)
    0000110001100000 size(64), length(11)

```



```

    0000101101000000 size(64), length(10)
    -----
OR (|) 0000111101100000 size(64), length(11)

    0000110001100000 size(64), length(11)
    0000101101000000 size(64), length(10)
    -----
XOR (^) 0000011100100000 size(64), length(11)

```

**Caution** Unlike `Vector` and `Hashtable`, `BitSet` is not synchronized. You must externally synchronize access to this class when using `BitSet` in a multithreaded context.

The Collections Framework has made `Vector`, `Enumeration`, `Stack`, `Dictionary`, and `Hashtable` obsolete. These types continue to be part of the standard class library to support legacy code. Also, the Preferences API has made `Properties` largely obsolete. Because `BitSet` is still relevant, this class continues to be improved (as recently as Java 7).

**Note** It's not surprising that `BitSet` is being improved when you realize the usefulness of variable-length bitsets. Because of their compactness and other advantages, variable-length bitsets are often used to implement an operating system's priority queues and facilitate memory page allocation. Unix-oriented file systems also use bitsets to facilitate the allocation of *inodes* (information nodes) and disk sectors. And bitsets are useful in *Huffman coding*, a data-compression algorithm for achieving lossless data compression.

## EXERCISES

The following exercises are designed to test your understanding of Chapter 9's content.

1. What is a collection?
2. What is the Collections Framework?
3. The Collections Framework largely consists of what components?
4. Define `comparable`.
5. When would you have a class implement the `Comparable` interface?
6. What is a comparator and what is its purpose?
7. True or false: A collection uses a comparator to define the natural ordering of its elements.
8. What does the `Iterable` interface describe?
9. What does the `Collection` interface represent?

10. Identify a situation where `Collection`'s `add()` method would throw an instance of the `UnsupportedOperationException` class.
11. `Iterable`'s `iterator()` method returns an instance of a class that implements the `Iterator` interface. What methods does this interface provide?
12. What is the purpose of the enhanced for loop statement?
13. How is the enhanced for loop statement expressed?
14. True or false: The enhanced for loop works with arrays.
15. Define autoboxing.
16. Define unboxing.
17. What is a list?
18. What does a `ListIterator` instance use to navigate through a list?
19. What is a view?
20. Why would you use the `subList()` method?
21. What does the `ArrayList` class provide?
22. What does the `LinkedList` class provide?
23. Define node.
24. True or false: `ArrayList` provides faster element insertions and deletions than `LinkedList`.
25. What is a set?
26. What does the `TreeSet` class provide?
27. What does the `HashSet` class provide?
28. True or false: To avoid duplicate elements in a hashset, your own classes must correctly override `equals()` and `hashCode()`.
29. What is the difference between `HashSet` and `LinkedHashSet`?
30. What does the `EnumSet` class provide?
31. Define sorted set.
32. What is a navigable set?
33. True or false: `HashSet` is an example of a sorted set.
34. Why would a sorted set's `add()` method throw `ClassCastException` when you attempt to add an element to the sorted set?
35. What is a queue?
36. True or false: `Queue`'s `element()` method throws `NoSuchElementException` when it is called on an empty queue.
37. What does the `PriorityQueue` class provide?
38. What is a map?

39. What does the `TreeMap` class provide?
40. What does the `HashMap` class provide?
41. What does a hashtable use to map keys to integer values?
42. Continuing from the previous question, what are the resulting integer values called and what do they accomplish?
43. What is a hashtable's capacity?
44. What is a hashtable's load factor?
45. What is the difference between `HashMap` and `LinkedHashMap`?
46. What does the `IdentityHashMap` class provide?
47. What does the `EnumMap` class provide?
48. Define sorted map.
49. What is a navigable map?
50. True or false: `TreeMap` is an example of a sorted map.
51. What is the purpose of the `Arrays` class's static `<T> List<T> asList(T... array)` method?
52. True or false: Binary search is slower than linear search.
53. Which `Collections` method would you use to return a synchronized variation of a hashset?
54. Identify the seven legacy collections-oriented types.
55. As an example of array list usefulness, create a `JavaQuiz` application that presents a multiple-choice-based quiz on Java features. The `JavaQuiz` class's `main()` method first populates the array list with the entries in a `QuizEntry` array (such as `new QuizEntry("What was Java's original name?", new String[] { "Oak", "Duke", "J", "None of the above" }, 'A')`). Each entry consists of a question, four possible answers, and the letter (A, B, C, or D) of the correct answer. `main()` then uses the array list's `iterator()` method to return an `Iterator` instance and this instance's `hasNext()` and `next()` methods to iterate over the list. Each of the iterations outputs the question and four possible answers and then prompts the user to enter the correct choice. After the user enters A, B, C, or D (via `System.in.read()`), `main()` outputs a message stating whether or not the user made the correct choice.
56. Why is `(int) (f ^ (f >>> 32))` used instead of `(int) (f ^ (f >> 32))` in the hash code generation algorithm?
57. `Collections` provides the static `int frequency(Collection<?> c, Object o)` method to return the number of collection `c` elements that are equal to `o`. Create a `FrequencyDemo` application that reads its command-line arguments and stores all arguments except for the last argument in a list and then calls `frequency()` with the list and last command-line argument as this method's arguments. It then outputs this method's return value (the number of occurrences of the last command-line argument in the previous command-line arguments). For example, `java FrequencyDemo` should output `Number of occurrences of null = 0`, and `java FrequencyDemo how much wood could a woodchuck chuck if a woodchuck could chuck wood wood` should output `Number of occurrences of wood = 2`.

## Summary

A collection is a group of objects that are stored in an instance of a class designed for this purpose. To save you from having to create your own collections classes, Java provides the Collections Framework for representing and manipulating collections.

The Collections Framework largely consists of core interfaces, implementation classes, and the Arrays and Collections utility classes. The core interfaces make it possible to manipulate collections independently of their implementations.

Core interfaces include `Iterable`, `Collection`, `List`, `Set`, `SortedSet`, `NavigableSet`, `Queue`, `Deque`, `Map`, `SortedMap`, and `NavigableMap`. `Collection` extends `Iterable`; `List`, `Set`, and `Queue` each extend `Collection`; `SortedSet` extends `Set`; `NavigableSet` extends `SortedSet`; `Deque` extends `Queue`; `SortedMap` extends `Map`; and `NavigableMap` extends `SortedMap`.

Implementation classes include `ArrayList`, `LinkedList`, `TreeSet`, `HashSet`, `LinkedHashSet`, `EnumSet`, `PriorityQueue`, `ArrayDeque`, `TreeMap`, `HashMap`, `LinkedHashMap`, `IdentityHashMap`, `WeakHashMap`, and `EnumMap`. The name of each concrete class ends in a core interface name, identifying the core interface on which it is based.

The Collections Framework would not be complete without its Arrays and Collections utility classes. Each class supplies various class methods that implement useful algorithms in the contexts of arrays and collections. For example, `Arrays` lets you efficiently search and sort arrays, and `Collections` lets you obtain synchronized and unmodifiable collections.

Before Java 1.2's introduction of the Collections Framework, developers could create their own frameworks or use the `Vector`, `Enumeration`, `Stack`, `Dictionary`, `Hashtable`, `Properties`, and `BitSet` types, which were introduced by Java 1.0.

The Collections Framework has made `Vector`, `Enumeration`, `Stack`, `Dictionary`, and `Hashtable` obsolete. Also, the Preferences API has made `Properties` largely obsolete. Because `BitSet` is still relevant, this class continues to be improved.

In Chapter 10 I explore the Concurrency Utilities API suite, which is Java's concurrency counterpart to the Collections Framework.

# Exploring the Concurrency Utilities

Chapter 7 introduced Java's Threads API. Significant problems with Threads resulted in the development of the more powerful Concurrency Utilities Framework. In this chapter, I take you on a tour of this framework from Android's perspective. Note that you won't find a discussion of newer features, such as the Fork/Join Framework, because Android doesn't support them.

## Introducing the Concurrency Utilities

The low-level Threads API lets you create multithreaded applications that offer better performance and responsiveness over their single-threaded counterparts. However, there are problems:

- Low-level concurrency primitives, such as `synchronized` and `wait()/notify()`, are often hard to use correctly. Incorrect use of these primitives can result in race conditions, thread starvation, deadlock, and other hazards, which can be hard to detect and debug.
- Too much reliance on the `synchronized` primitive can lead to performance issues, which affect an application's *scalability*. This is a significant problem for highly threaded applications such as web servers.
- Developers often need to use higher-level constructs such as thread pools and semaphores. Because these constructs aren't included with Java's low-level threading capabilities, developers have been forced to build their own constructs, which is a time-consuming and error-prone activity.

To address these problems, Java 5 introduced the *Concurrency Utilities*, a powerful and extensible framework of high-performance threading utilities such as thread pools and blocking queues. This framework consists of the following packages:

- `java.util.concurrent` contains utility types that are often used in concurrent programming, for example, executors, thread pools, and concurrent hashmaps.
- `java.util.concurrent.atomic` contains utility classes that support lock-free, thread-safe programming on single variables.
- `java.util.concurrent.locks` contains utility types for locking and waiting on *conditions* (objects that let threads suspend execution [wait] until notified by other threads that some Boolean state may now be true). Locking and waiting via these types provides better performance and is more flexible than doing so via Java's monitor-based synchronization and wait/notification mechanisms.

This framework also introduces a long `nanoTime()` method to the `java.lang.System` class, which lets you access a nanosecond-granularity time source for making relative time measurements.

**Note** Two terms that are commonly encountered when exploring the Concurrency Utilities framework are parallelism and concurrency. According to Oracle's "Multithreading Guide" (<http://docs.oracle.com/cd/E19455-01/806-5257/6je9h032b/index.html>), *parallelism* is "a condition that arises when at least two threads are **executing** simultaneously." In contrast, *concurrency* is "a condition that exists when at least two threads are **making progress** [simultaneously or not. It is a] more generalized form of parallelism that can include time-slicing as a form of virtual parallelism."

The concurrency utilities can be classified as executors, synchronizers, concurrent collections, a locking framework, and atomic variables. I explore each category in the following sections.

## Exploring Executors

The Threads API lets you execute runnable tasks via expressions such as `new java.lang.Thread(new RunnableTask()).start();` These expressions tightly couple task submission with the task's execution mechanics (run on the current thread, a new thread, or a thread arbitrarily chosen from a *pool* [group] of threads).

**Note** A *task* is an object whose class implements the `java.lang.Runnable` interface (a runnable task) or the `java.util.concurrent.Callable` interface (a callable task).

The concurrency-oriented utilities provide executors as a high-level alternative to low-level Threads API expressions for executing runnable tasks. An *executor* is an object whose class directly or indirectly implements the `java.util.concurrent.Executor` interface, which decouples task submission from task-execution mechanics.

**Note** The executor framework's use of interfaces to decouple task submission from task-execution mechanics is analogous to the Collections Framework's use of core interfaces to decouple lists, sets, queues, and maps from their implementations. Decoupling results in flexible code that's easier to maintain.

Executor declares a solitary `void execute(Runnable runnable)` method that executes the runnable task named `runnable` at some point in the future. `execute()` throws `java.lang.NullPointerException` when `runnable` is null and `java.util.concurrent.RejectedExecutionException` when it cannot execute `runnable`.

**Note** `RejectedExecutionException` can be thrown when an executor is shutting down and doesn't want to accept new tasks. Also, this exception can be thrown when the executor doesn't have enough room to store the task (perhaps the executor uses a bounded blocking queue to store tasks and the queue is full. I discuss blocking queues later in this chapter).

The following example presents the Executor equivalent of the aforementioned `new Thread(new RunnableTask()).start();` expression:

```
Executor executor = ...; // ... represents some executor creation
executor.execute(new RunnableTask());
```

Although Executor is easy to use, this interface is limited in various ways:

- Executor focuses exclusively on `Runnable`. Because `Runnable`'s `run()` method doesn't return a value, there's no convenient way for a runnable task to return a value to its caller.
- Executor doesn't provide a way to track the progress of runnable tasks that are executing, cancel an executing runnable task, or determine when the runnable task finishes execution.
- Executor cannot execute a collection of runnable tasks.
- Executor doesn't provide a way for an application to shut down an executor (much less to shut down an executor properly).

These limitations are addressed by the `java.util.concurrent.ExecutorService` interface, which extends `Executor` and whose implementation is typically a thread pool. Table 10-1 describes `ExecutorService`'s methods.

**Table 10-1.** *ExecutorService Methods*

Method	Description
boolean awaitTermination(long timeout, TimeUnit unit)	Blocks (waits) until all tasks have finished after a shutdown request, the timeout (measured in unit time units) expires, or the current thread is interrupted, whichever happens first. Returns true when this executor has terminated and false when the timeout elapses before termination. This method throws <code>java.lang.InterruptedException</code> when interrupted.
<T> List<Future<T>> invokeAll(Collection<? extends Callable<T>> tasks)	Executes each callable task in the tasks collection and returns a <code>java.util.List</code> of <code>java.util.concurrent.Future</code> instances that hold task statuses and results when all tasks complete—a task completes through normal termination or by throwing an exception. The <code>List</code> of Futures is in the same sequential order as the sequence of tasks returned by tasks' iterator. This method throws <code>InterruptedException</code> when it's interrupted while waiting, in which case unfinished tasks are canceled; <code>NullPointerException</code> when tasks or any of its elements is null; and <code>RejectedExecutionException</code> when any one of tasks' tasks cannot be scheduled for execution.
<T> List<Future<T>> invokeAll(Collection<? extends Callable<T>> tasks, long timeout, TimeUnit unit)	Executes each callable task in the tasks collection and returns a <code>List</code> of <code>Future</code> instances that hold task statuses and results when all tasks complete—a task completes through normal termination or by throwing an exception—or the timeout (measured in unit time units) expires. Tasks that are not completed at expiry are canceled. The <code>List</code> of Futures is in the same sequential order as the sequence of tasks returned by tasks' iterator. This method throws <code>InterruptedException</code> when it's interrupted while waiting, in which case unfinished tasks are canceled. It also throws <code>NullPointerException</code> when tasks, any of its elements, or unit is null; and throws <code>RejectedExecutionException</code> when any one of tasks' tasks cannot be scheduled for execution.
<T> T invokeAny(Collection<? extends Callable<T>> tasks)	Executes the given tasks, returning the result of an arbitrary task that's completed successfully (in other words, without throwing an exception), if any does. On normal or exceptional return, tasks that haven't completed are canceled. This method throws <code>InterruptedException</code> when it's interrupted while waiting, <code>NullPointerException</code> when tasks or any of its elements is null, <code>java.lang.IllegalArgumentException</code> when tasks is empty, <code>java.util.concurrent.ExecutionException</code> when no task completes successfully, and <code>RejectedExecutionException</code> when none of the tasks can be scheduled for execution.
<T> T invokeAny(Collection<? extends Callable<T>> tasks, long timeout, TimeUnit unit)	Executes the given tasks, returning the result of an arbitrary task that's completed successfully (in other words, without throwing an exception), if any does before the timeout (measured in unit time units) expires—tasks that are not completed at expiry are canceled. On normal or exceptional return, tasks that have not completed are canceled. This method throws <code>InterruptedException</code> when it's interrupted while waiting; <code>NullPointerException</code> when tasks, any of its elements, or unit is null; <code>IllegalArgumentException</code> when tasks is empty; <code>java.util.concurrent.TimeoutException</code> when the timeout elapses before any task successfully completes; <code>ExecutionException</code> when no task completes successfully; and <code>RejectedExecutionException</code> when none of the tasks can be scheduled for execution.

*(continued)*



Table 10-1. (continued)

Method	Description
<code>boolean isShutdown()</code>	Returns true when this executor has been shut down; otherwise, returns false.
<code>boolean isTerminated()</code>	Returns true when all tasks have completed following shutdown; otherwise, returns false. This method will never return true prior to <code>shutdown()</code> or <code>shutdownNow()</code> being called.
<code>void shutdown()</code>	Initiates an orderly shutdown in which previously submitted tasks are executed, but no new tasks will be accepted. Calling this method has no effect after the executor has shut down. This method doesn't wait for previously submitted tasks to complete execution. Use <code>awaitTermination()</code> when waiting is necessary.
<code>List&lt;Runnable&gt; shutdownNow()</code>	Attempts to stop all actively executing tasks, halt the processing of waiting tasks, and return a list of the tasks that were awaiting execution. There are no guarantees beyond best-effort attempts to stop processing actively executing tasks. For example, typical implementations will cancel via <code>Thread.interrupt()</code> , so any task that fails to respond to interrupts may never terminate.
<code>&lt;T&gt; Future&lt;T&gt; submit(Callable&lt;T&gt; task)</code>	Submits a callable task for execution and returns a <code>Future</code> instance representing task's pending results. The <code>Future</code> instance's <code>get()</code> method returns task's result on successful completion. This method throws <code>RejectedExecutionException</code> when task cannot be scheduled for execution and <code>NullPointerException</code> when task is null. If you would like to block immediately while waiting for a task to complete, you can use constructions of the form <code>result = exec.submit(aCallable).get();</code> .
<code>Future&lt;?&gt; submit(Runnable task)</code>	Submits a runnable task for execution and returns a <code>Future</code> instance representing task's pending results. The <code>Future</code> instance's <code>get()</code> method returns task's result on successful completion. This method throws <code>RejectedExecutionException</code> when task cannot be scheduled for execution and <code>NullPointerException</code> when task is null.
<code>&lt;T&gt; Future&lt;T&gt; submit(Runnable task, T result)</code>	Submits a runnable task for execution and returns a <code>Future</code> instance whose <code>get()</code> method returns result on successful completion. This method throws <code>RejectedExecutionException</code> when task cannot be scheduled for execution and <code>NullPointerException</code> when task is null.

Table 10-1 refers to `java.util.concurrent.TimeUnit`, an enum that represents time durations at given units of granularity: `DAYS`, `HOURS`, `MICROSECONDS`, `MILLISECONDS`, `MINUTES`, `NANOSECONDS`, and `SECONDS`. Furthermore, `TimeUnit` declares methods for converting across units (such as `long toHours(long duration)`), and for performing timing and delay operations (such as `void sleep(long timeout)`) in these units.

Table 10-1 also refers to *callable tasks*, which are analogous to runnable tasks. Unlike `Runnable`, whose `void run()` method cannot throw checked exceptions, `Callable<V>` declares a `V call()` method that returns a value and which can throw checked exceptions because `call()` is declared with a `throws Exception` clause.

Finally, Table 10-1 refers to the `Future` interface, which represents the result of an asynchronous computation. The result is known as a *future*, because it typically will not be available until some moment in the future. `Future`, whose generic type is `Future<V>`, provides methods for canceling a task, for returning a task's value, and for determining whether or not the task has finished. Table 10-2 describes `Future`'s methods.

**Table 10-2.** *Future Methods*

Method	Description
<code>boolean cancel(boolean mayInterruptIfRunning)</code>	Attempts to cancel execution of this task and returns true when the task was canceled; otherwise, returns false (perhaps the task completed normally before this method was called).  The cancellation attempt fails when the task is done, canceled, or couldn't be canceled for another reason. If successful and this task hadn't started when <code>cancel()</code> was called, the task should never run. If the task has started, <code>mayInterruptIfRunning</code> determines whether (true) or not (false) the thread executing this task should be interrupted in an attempt to stop the task. After returning, subsequent calls to <code>isDone()</code> always return true; <code>isCancelled()</code> always return true when <code>cancel()</code> returns true.
<code>V get()</code>	Waits if necessary for the task to complete and then returns the result. This method throws <code>java.util.concurrent.CancellationException</code> when the task was canceled prior to this method being called, <code>ExecutionException</code> when the task threw an exception, and <code>InterruptedException</code> when the current thread was interrupted while waiting.
<code>V get(long timeout, TimeUnit unit)</code>	Waits at most <code>timeout</code> units (as specified by <code>unit</code> ) for the task to complete and then returns the result (if available). This method throws <code>CancellationException</code> when the task was canceled prior to this method being called, <code>ExecutionException</code> when the task threw an exception, <code>InterruptedException</code> when the current thread was interrupted while waiting, and <code>TimeoutException</code> when this method's timeout value expires (the wait times out).
<code>boolean isCancelled()</code>	Returns true when this task was canceled before it completed normally; otherwise, returns false.
<code>boolean isDone()</code>	Returns true when this task completed; otherwise, returns false. Completion may be due to normal termination, an exception, or cancellation; this method returns true in all of these cases.

Suppose that you intend to write an application whose graphical user interface lets the user enter a word. After the user enters the word, the application presents this word to several online dictionaries and obtains each dictionary's entry. These entries are subsequently displayed to the user.

Because online access can be slow, and because the user interface should remain responsive (perhaps the user might want to end the application), you offload the “obtain word entries” task to an executor that runs this task on a separate thread. The following example uses `ExecutorService`, `Callable`, and `Future` to accomplish this objective:

```
ExecutorService executor = ...; // ... represents some executor creation
Future<String[]> taskFuture = executor.submit(new Callable<String[]>()
{
    @Override
    public String[] call()
    {
        String[] entries = ...;
        // Access online dictionaries
        // with search word and populate
        // entries with their resulting
        // entries.
        return entries;
    }
});

// Do stuff.
String entries = taskFuture.get();
```

After obtaining an executor in some manner (you will learn how to do this shortly), the example’s main thread submits a callable task to the executor. The `submit()` method immediately returns with a reference to a `Future` object for controlling task execution and accessing results. The main thread ultimately calls this object’s `get()` method to get these results.

**Note** The `java.util.concurrent.ScheduledExecutorService` interface extends `ExecutorService` and describes an executor that lets you schedule tasks to run once or to execute periodically after a given delay.

Although you could create your own `Executor`, `ExecutorService`, and `ScheduledExecutorService` implementations (such as class `DirectExecutor` implements `Executor` { `@Override public void execute(Runnable r) { r.run(); }` }—run executor directly on the calling thread), there’s a simpler alternative: `java.util.concurrent.Executors`.

**Tip** If you intend to create your own `ExecutorService` implementations, you will find it helpful to work with the `java.util.concurrent.AbstractExecutorService` and `java.util.concurrent.FutureTask` classes.

The Executors utility class declares several class methods that return instances of various `ExecutorService` and `ScheduledExecutorService` implementations (and other kinds of instances). This class's static methods accomplish the following tasks:

- Create and return an `ExecutorService` instance that's configured with commonly used configuration settings.
- Create and return a `ScheduledExecutorService` instance that's configured with commonly used configuration settings.
- Create and return a “wrapped” `ExecutorService` or `ScheduledExecutorService` instance that disables reconfiguration of the executor service by making implementation-specific methods inaccessible.
- Create and return a `java.util.concurrent.ThreadFactory` instance (that is, an instance of a class that implements the `ThreadFactory` interface) for creating new threads.
- Create and return a `Callable` instance out of other closure-like forms so that it can be used in execution methods that require `Callable` arguments (such as `ExecutorService`'s `submit(Callable)` method). (Wikipedia's “Closure (computer science)” entry [[http://en.wikipedia.org/wiki/Closure\\_\(computer\\_science\)](http://en.wikipedia.org/wiki/Closure_(computer_science))] introduces the topic of closures.)

For example, static `ExecutorService newFixedThreadPool(int nThreads)` creates a thread pool that reuses a fixed number of threads operating off of a shared unbounded queue. At most, `nThreads` threads are actively processing tasks. If additional tasks are submitted when all threads are active, they wait in the queue for an available thread.

If any thread terminates because of a failure during execution before the executor shuts down, a new thread will take its place when needed to execute subsequent tasks. The threads in the pool will exist until the executor is explicitly shut down. This method throws `IllegalArgumentException` when you pass zero or a negative value to `nThreads`.

**Note** Thread pools are used to eliminate the overhead from having to create a new thread for each submitted task. Thread creation isn't cheap, and having to create many threads could severely impact an application's performance.

You would commonly use executors, runnables, callables, and futures in file and network input/output contexts. Performing a lengthy calculation offers another scenario where you could use these types. For example, Listing 10-1 uses an executor, a callable, and a future in a calculation context of Euler's number  $e$  (2.71828. . .).

*Listing 10-1. Calculating Euler's Number*

```
import java.math.BigDecimal;
import java.math.MathContext;
import java.math.RoundingMode;
```

```

import java.util.concurrent.Callable;
import java.util.concurrent.ExecutionException;
import java.util.concurrent.ExecutorService;
import java.util.concurrent.Executors;
import java.util.concurrent.Future;

public class CalculateE
{
    final static int LASTITER = 17;

    public static void main(String[] args)
    {
        ExecutorService executor = Executors.newFixedThreadPool(1);
        Callable<BigDecimal> callable;
        callable = new Callable<BigDecimal>()
        {
            @Override
            public BigDecimal call()
            {
                MathContext mc = new MathContext(100,
                                                RoundingMode.HALF_UP);
                BigDecimal result = BigDecimal.ZERO;
                for (int i = 0; i <= LASTITER; i++)
                {
                    BigDecimal factorial = factorial(new BigDecimal(i));
                    BigDecimal res = BigDecimal.ONE.divide(factorial, mc);
                    result = result.add(res);
                }
                return result;
            }

            public BigDecimal factorial(BigDecimal n)
            {
                if (n.equals(BigDecimal.ZERO))
                    return BigDecimal.ONE;
                else
                    return n.multiply(factorial(n.subtract(BigDecimal.ONE)));
            }
        };
        Future<BigDecimal> taskFuture = executor.submit(callable);
        try
        {
            while (!taskFuture.isDone())
                System.out.println("waiting");
            System.out.println(taskFuture.get());
        }
        catch (ExecutionException ee)
        {
            System.err.println("task threw an exception");
            System.err.println(ee);
        }
    }
}

```

```

    catch(InterruptedException ie)
    {
        System.err.println("interrupted while waiting");
    }
    executor.shutdownNow();
}
}

```

The main thread that executes Listing 10-1's `main()` method first obtains an executor by calling `Executors.newFixedThreadPool()` method. It then instantiates an anonymous class that implements the `Callable` interface and submits this task to the executor, receiving a `Future` instance in response.

After submitting a task, a thread typically does some other work until it requires the task's result. I've chosen to simulate this work by having the main thread repeatedly output a waiting message until the `Future` instance's `isDone()` method returns true. (In a realistic application, I would avoid this looping.) At this point, the main thread calls the instance's `get()` method to obtain the result, which is then output. The main thread then shuts down the executor.

**Caution** It's important to shut down the executor after it completes; otherwise, the application might not end. The previous executor accomplishes this task by calling `shutdownNow()`. (You could also use the `shutdown()` method.)

The callable's `call()` method calculates  $e$  by evaluating the mathematical power series  $e = 1 / 0! + 1 / 1! + 1 / 2! + \dots$ . This series can be evaluated by summing  $1 / n!$ , where  $n$  ranges from 0 to infinity.

`call()` first instantiates `java.math.MathContext` to encapsulate a *precision* (number of digits) and a rounding mode. I chose 100 as an upper limit on  $e$ 's precision, and I also chose `HALF_UP` as the rounding mode.

**Tip** Increase the precision as well as `LASTITER`'s value to converge the series to a lengthier and more accurate approximation of  $e$ .

`call()` next initializes a `java.math.BigDecimal` local variable named `result` to `BigDecimal.ZERO`. It then enters a loop that calculates a factorial, divides `BigDecimal.ONE` by the factorial, and adds the division result to `result`.

The `divide()` method takes the `MathContext` instance as its second argument to ensure that the division doesn't result in a *nonterminating decimal expansion* (the quotient result of the division cannot be represented exactly—`0.3333333...`, for example), which throws `java.lang.ArithmeticException` (to alert the caller to the fact that the quotient cannot be represented exactly), which the executor rethrows as `ExecutionException`.

When you run this application, you should observe output similar to the following:

---

```
waiting
waiting
waiting
waiting
waiting
2.7182818284590450705160477958486050611789796352510326989007350040652250425048433140558879743442457
41730039454062711
```

---

## Exploring Synchronizers

The Threads API offers synchronization primitives for synchronizing thread access to critical sections. Because it can be difficult to write synchronized code correctly that's based on these primitives, Concurrency Utilities includes *synchronizers*, classes that facilitate common forms of synchronization.

Four commonly used synchronizers are countdown latches, cyclic barriers, exchangers, and semaphores. I explore each synchronizer in this section.

### Countdown Latches

A *countdown latch* causes one or more threads to wait at a “gate” until another thread opens this gate, at which point these other threads can continue. It consists of a count and operations for “causing a thread to wait until the count reaches zero” and “decrementing the count.”

The `java.util.concurrent.CountDownLatch` class implements the countdown latch synchronizer. You initialize a `CountDownLatch` instance to a specific count by invoking this class's `CountDownLatch(int count)` constructor. This constructor throws `IllegalArgumentException` when the value passed to `count` is negative.

`CountDownLatch` also offers the following methods:

- `void await():` Forces the calling thread to wait until the latch has counted down to zero, unless the thread is interrupted, in which case `InterruptedException` is thrown. This method returns immediately when the count is zero.
- `boolean await(long timeout, TimeUnit unit):` Forces the calling thread to wait until the latch has counted down to zero or the specified timeout value in `unit` time-units has expired, or the thread is interrupted, in which case `InterruptedException` is thrown. This method returns immediately when the count is zero. It returns `true` when the count reaches zero or `false` when the waiting time elapses.
- `void countDown():` Decrements the count, releasing all waiting threads when the count reaches zero. Nothing happens when the count is already zero when this method is called.

- `long getCount()`: Returns the current count. This method is useful for testing and debugging.
- `String toString()`: Returns a string identifying this latch as well as its state. The state, in brackets, includes string literal "Count =" followed by the current count.

You'll often use a countdown latch to ensure that threads start working at approximately the same time. For example, check out Listing 10-2.

*Listing 10-2. Using a Countdown Latch to Trigger a Coordinated Start*

```
import java.util.concurrent.CountDownLatch;
import java.util.concurrent.ExecutorService;
import java.util.concurrent.Executors;

public class CountdownLatchDemo
{
    final static int NTHREADS = 3;

    public static void main(String[] args)
    {
        final CountdownLatch startSignal = new CountdownLatch(1);
        final CountdownLatch doneSignal = new CountdownLatch(NTHREADS);
        Runnable r = new Runnable()
        {
            @Override
            public void run()
            {
                try
                {
                    report("entered run()");
                    startSignal.await(); // wait until told to proceed
                    report("doing work");
                    Thread.sleep((int) (Math.random() * 1000));
                    doneSignal.countDown(); // reduce count on which
                                           // main thread is waiting
                }
                catch (InterruptedException ie)
                {
                    System.err.println(ie);
                }
            }
        };

        void report(String s)
        {
            System.out.println(System.currentTimeMillis() + ": " +
                               Thread.currentThread() + ": " + s);
        }
    }
};
```



```

ExecutorService executor = Executors.newFixedThreadPool(NTHREADS);
for (int i = 0; i < NTHREADS; i++)
    executor.execute(r);
try
{
    System.out.println("main thread doing something");
    Thread.sleep(1000); // sleep for 1 second
    startSignal.countDown(); // let all threads proceed
    System.out.println("main thread doing something else");
    doneSignal.await(); // wait for all threads to finish
    executor.shutdownNow();
}
catch (InterruptedException ie)
{
    System.err.println(ie);
}
}
}

```

Listing 10-2's main thread first creates a pair of countdown latches. The `startSignal` countdown latch prevents any worker thread from proceeding until the main thread is ready for them to proceed. The `doneSignal` countdown latch causes the main thread to wait until all worker threads have finished.

The main thread next creates a runnable whose `run()` method is executed by subsequently-created worker threads.

The `run()` method first outputs an initial message and then calls `startSignal`'s `await()` method to wait for this countdown latch's count to read zero before it can proceed. Once this happens, `run()` outputs a message that indicates work being done and sleeps for a random period of time (0 through 999 milliseconds) to simulate this work.

At this point, `run()` invokes `doneSignal`'s `countDown()` method to decrement this latch's count. Once this count reaches zero, the main thread waiting on this signal will continue, shutting down the executor and terminating the application.

After creating the runnable, the main thread obtains an executor that's based on a thread pool of `NTHREADS` threads, and then calls the executor's `execute()` method `NTHREADS` times, passing the runnable to each of the `NTHREADS` pool-based threads. This action starts the worker threads, which enter `run()`.

Next, the main thread outputs a message and sleeps for one second to simulate doing additional work (giving all the worker threads a chance to have entered `run()` and invoke `startSignal.await()`), invokes `startSignal`'s `countDown()` method to cause the worker threads to start running, outputs a message to indicate that it's doing something else, and invokes `doneSignal`'s `await()` method to wait for this countdown latch's count to reach zero before it can proceed.

Compile Listing 10-2:

```
javac CountdownLatchDemo.java
```

When you run this application (`java CountdownLatchDemo`), you'll observe output similar to the following:

---

```
main thread doing something
1384281251694: Thread[pool-1-thread-1,5,main]: entered run()
1384281251694: Thread[pool-1-thread-2,5,main]: entered run()
1384281251694: Thread[pool-1-thread-3,5,main]: entered run()
main thread doing something else
1384281252723: Thread[pool-1-thread-3,5,main]: doing work
1384281252723: Thread[pool-1-thread-2,5,main]: doing work
1384281252723: Thread[pool-1-thread-1,5,main]: doing work
```

---

## Cyclic Barriers

A *cyclic barrier* lets a set of threads wait for each other to reach a common barrier point. The barrier is *cyclic* because it can be reused after the waiting threads are released. This synchronizer is useful in applications involving a fixed-size party of threads that must occasionally wait for each other.

The `java.util.concurrent.CyclicBarrier` class implements the cyclic barrier synchronizer. You initialize a `CyclicBarrier` instance to a specific number of *parties* (threads working toward a common goal) by invoking this class's `CyclicBarrier(int parties)` constructor. This constructor throws `IllegalArgumentException` when the value passed to `parties` is less than 1.

Alternatively, you can invoke the `CyclicBarrier(int parties, Runnable barrierAction)` constructor to initialize a cyclic barrier to a specific number of parties and a `barrierAction` that's executed when the barrier is *tripped*. In other words, when `parties - 1` threads are waiting and one more thread arrives, that thread executes `barrierAction` and then all threads proceed. This runnable is useful for updating shared state before any of the threads continue. This constructor throws `IllegalArgumentException` when the value passed to `parties` is less than 1. (The former constructor invokes this constructor passing `null` to `barrierAction`; no runnable will be executed when the barrier is tripped.)

`CyclicBarrier` also offers the following methods:

- `int await()`: Forces the calling thread to wait until all parties have invoked `await()` on this cyclic barrier. The calling thread will also stop waiting when it or another waiting thread is interrupted, another thread times out while waiting, or another thread invokes `reset()` on this cyclic barrier. If the calling thread has its interrupted status set on entry or is interrupted while waiting, this method throws `InterruptedException`. It throws `java.util.concurrent.BrokenBarrierException` when the barrier is `reset()` while any thread is waiting or when the barrier is broken when `await()` is invoked. When any thread is interrupted while waiting, all other waiting threads throw `BrokenBarrierException` and the barrier is placed into the broken state. If the calling thread is the last thread to arrive and a non-null `barrierAction` was supplied in the constructor, the calling thread executes this runnable before allowing the other threads to continue. This method returns the arrival index of the calling thread, where `index getParties() - 1` indicates the first thread to arrive and zero indicates the last thread to arrive.

- `int await(long timeout, TimeUnit unit)`: This method is equivalent to the previous method except that it lets you specify how long the calling thread is willing to wait. This method throws `TimeoutException` when this timeout expires while the thread is waiting.
- `int getNumberWaiting()`: Returns the number of parties that are currently waiting at the barrier. This method is useful for debugging and in partnership with assertions.
- `int getParties()`: Returns the number of parties that are required to trip the barrier.
- `boolean isBroken()`: Returns true when one or more parties broke out of this barrier because of interruption or timeout since the cyclic barrier was constructed or the last reset, or when a barrier action failed because of an exception; otherwise, returns false.
- `void reset()`: Resets the barrier to its initial state. If any parties are currently waiting at the barrier, they will return with a `BrokenBarrierException`. Note that resets after a breakage has occurred for other reasons can be complicated to carry out; threads need to resynchronize in some other way, and choose one thread to perform the reset. Therefore, it might be preferable to create a new barrier for subsequent use.

Cyclic barriers are useful in *parallel decomposition* scenarios where a lengthy task is divided into subtasks whose individual results are later merged into the overall result of the task. `CyclicBarrier`'s Javadoc presents example code that's completed in Listing 10-3.

*Listing 10-3. Using a Cyclic Barrier to Decompose a Task Into Subtasks*

```
import java.util.concurrent.BrokenBarrierException;
import java.util.concurrent.CyclicBarrier;

public class CyclicBarrierDemo
{
    public static void main(String[] args)
    {
        float[][] matrix = new float[3][3];
        int counter = 0;
        for (int row = 0; row < matrix.length; row++)
            for (int col = 0; col < matrix[0].length; col++)
                matrix[row][col] = counter++;
        dump(matrix);
        System.out.println();
        Solver solver = new Solver(matrix);
        System.out.println();
        dump(matrix);
    }
}
```

```
static void dump(float[][] matrix)
{
    for (int row = 0; row < matrix.length; row++)
    {
        for (int col = 0; col < matrix[0].length; col++)
            System.out.print(matrix[row][col] + " ");
        System.out.println();
    }
}
```

```
class Solver
{
    final int N;
    final float[][] data;
    final CyclicBarrier barrier;

    class Worker implements Runnable
    {
        int myRow;
        boolean done = false;

        Worker(int row)
        {
            myRow = row;
        }

        boolean done()
        {
            return done;
        }

        void processRow(int myRow)
        {
            System.out.println("Processing row: " + myRow);
            for (int i = 0; i < N; i++)
                data[myRow][i] *= 10;
            done = true;
        }

        @Override
        public void run()
        {
            while (!done())
            {
                processRow(myRow);

                try
                {
                    barrier.await();
                }
            }
        }
    }
}
```

```

        catch (InterruptedException ex)
        {
            return;
        }
        catch (BrokenBarrierException ex)
        {
            return;
        }
    }
}

public Solver(float[][] matrix)
{
    data = matrix;
    N = matrix.length;
    barrier = new CyclicBarrier(N,
        new Runnable()
        {
            @Override
            public void run()
            {
                mergeRows();
            }
        });
    for (int i = 0; i < N; ++i)
        new Thread(new Worker(i)).start();

    waitUntilDone();
}

void mergeRows()
{
    System.out.println("merging");
    synchronized("abc")
    {
        "abc".notify();
    }
}

void waitUntilDone()
{
    synchronized("abc")
    {
        try
        {
            System.out.println("main thread waiting");
            "abc".wait();
            System.out.println("main thread notified");
        }
    }
}

```

```

        catch (InterruptedException ie)
        {
            System.out.println("main thread interrupted");
        }
    }
}

```

Listing 10-3's main thread first creates a square matrix of floating-point values and dumps this matrix to the standard output stream. This thread then instantiates the `Solver` class, which creates a separate thread for performing a calculation on each row. The modified matrix is then dumped.

`Solver` presents a constructor that receives its `matrix` argument and saves its reference in field `data` along with the number of rows in field `N`. The constructor then creates a cyclic barrier with `N` parties and a barrier action that's responsible for merging all of the rows into a final matrix. Finally, the constructor creates a worker thread that executes a separate `Worker` runnable that's responsible for processing a single row in the matrix. The constructor then waits until the workers are finished.

`Worker`'s `run()` method repeatedly invokes `processRow()` on its specific row until `done()` returns true, which (in this example) it does after `processRow()` executes one time. After `processRow()` returns, which indicates that the row has been processed, the worker thread invokes `await()` on the cyclic barrier; it cannot proceed.

At some point, all of the worker threads will have invoked `await()`. When the final thread, which processes the final row in the matrix, invokes `await()`, it will trigger the barrier action, which merges all processed rows into a final matrix. In this example, a merger isn't required, but it would be required in more complex examples.

The final task performed by `mergeRows()` is to notify the main thread that invoked `Solver`'s constructor. This thread is waiting on the monitor associated with `String` object "abc". A call to `notify()` suffices to wake up the waiting thread, which is the only thread waiting on this monitor.

Compile Listing 10-3:

```
javac CyclicBarrierDemo.java
```

When you run this application (`java CyclicBarrierDemo`), you'll observe output similar to the following:

---

```

0.0 1.0 2.0
3.0 4.0 5.0
6.0 7.0 8.0

main thread waiting
Processing row: 1
Processing row: 2
Processing row: 0
merging
main thread notified

0.0 10.0 20.0
30.0 40.0 50.0
60.0 70.0 80.0

```

---

## Exchangers

An *exchanger* provides a synchronization point where threads can swap objects. Each thread presents some object on entry to the exchanger's `exchange()` method, matches with a partner thread, and receives its partner's object on return. Exchangers can be useful in applications such as genetic algorithms (see [http://en.wikipedia.org/wiki/Genetic\\_algorithm](http://en.wikipedia.org/wiki/Genetic_algorithm)) and pipeline designs.

The generic `java.util.concurrent.Exchanger<V>` class implements the exchanger synchronizer. You initialize an exchanger by invoking the `Exchanger()` constructor. You then invoke either of the following methods to perform an exchange:

- `V exchange(V x)`: Waits for another thread to arrive at this exchange point (unless the calling thread is interrupted), and then transfers the given object to it, receiving the other thread's object in return. If another thread is already waiting at the exchange point, it's resumed for thread scheduling purposes and receives the object passed in by the calling thread. The current thread returns immediately, receiving the object passed to the exchanger by the other thread. This throws `InterruptedException` when the calling thread is interrupted.
- `V exchange(V x, long timeout, TimeUnit unit)`: This method is equivalent to the previous method except that it lets you specify how long the calling thread is willing to wait. It throws `TimeoutException` when this timeout expires while the thread is waiting.

Listing 10-4 expands on the “repeated buffer filling and emptying” Exchanger example presented in Exchanger's Javadoc.

*Listing 10-4. Using an Exchanger to Swap Buffers*

```
import java.util.ArrayList;
import java.util.List;

import java.util.concurrent.Exchanger;

public class ExchangerDemo
{
    static Exchanger<DataBuffer> exchanger = new Exchanger<DataBuffer>();

    static DataBuffer initialEmptyBuffer = new DataBuffer();
    static DataBuffer initialFullBuffer = new DataBuffer("I");

    public static void main(String[] args)
    {
        class FillingLoop implements Runnable
        {
            int count = 0;
```

```
@Override
public void run()
{
    DataBuffer currentBuffer = initialEmptyBuffer;
    try
    {
        while (true)
        {
            addToBuffer(currentBuffer);
            if (currentBuffer.isFull())
            {
                System.out.println("filling thread wants to exchange");
                currentBuffer = exchanger.exchange(currentBuffer);
                System.out.println("filling thread receives an exchange");
            }
        }
    }
    catch (InterruptedException ie)
    {
        System.out.println("filling thread interrupted");
    }
}

void addToBuffer(DataBuffer buffer)
{
    String item = "NI" + count++;
    System.out.println("Adding: " + item);
    buffer.add(item);
}

class EmptyingLoop implements Runnable
{
    @Override
    public void run()
    {
        DataBuffer currentBuffer = initialFullBuffer;
        try
        {
            while (true)
            {
                takeFromBuffer(currentBuffer);
                if (currentBuffer.isEmpty())
                {
                    System.out.println("emptying thread wants to exchange");
                    currentBuffer = exchanger.exchange(currentBuffer);
                    System.out.println("emptying thread receives an exchange");
                }
            }
        }
    }
}
```



```
        catch (InterruptedException ie)
        {
            System.out.println("emptying thread interrupted");
        }
    }

    void takeFromBuffer(DataBuffer buffer)
    {
        System.out.println("taking: " + buffer.remove());
    }
}
new Thread(new EmptyingLoop()).start();
new Thread(new FillingLoop()).start();
}
```

```
class DataBuffer
{
    private final static int MAXITEMS = 10;

    private List<String> items = new ArrayList<String>();

    DataBuffer()
    {
    }

    DataBuffer(String prefix)
    {
        for (int i = 0; i < MAXITEMS; i++)
        {
            String item = prefix+i;
            System.out.printf("Adding %s\n", item);
            items.add(item);
        }
    }

    void add(String s)
    {
        if (!isFull())
            items.add(s);
    }

    boolean isEmpty()
    {
        return items.size() == 0;
    }

    boolean isFull()
    {
        return items.size() == MAXITEMS;
    }
}
```

```
String remove()
{
    if (!isEmpty())
        return items.remove(0);
    return null;
}
}
```

Listing 10-4's main thread creates an exchanger and a pair of buffers via static field initializers. It then instantiates the `EmptyingLoop` and `FillingLoop` local classes and passes these runnables to new `Thread` instances whose threads are then started. Each runnable's `run()` method enters an infinite loop that repeatedly adds to or removes from its buffer. When the buffer is full or empty, the exchanger is used to swap these buffers and the filling or emptying continues.

Compile Listing 10-4:

```
javac ExchangerDemo.java
```

When you run this application (`java ExchangerDemo`), you'll observe a prefix of the output similar to the following:

---

```
Adding I0
Adding I1
Adding I2
Adding I3
Adding I4
Adding I5
Adding I6
Adding I7
Adding I8
Adding I9
taking: I0
taking: I1
taking: I2
taking: I3
taking: I4
taking: I5
taking: I6
taking: I7
taking: I8
taking: I9
emptying thread wants to exchange
```

---

---

```
Adding: NI0
Adding: NI1
Adding: NI2
Adding: NI3
Adding: NI4
Adding: NI5
Adding: NI6
Adding: NI7
Adding: NI8
Adding: NI9
filling thread wants to exchange
filling thread receives an exchange
emptying thread receives an exchange
Adding: NI10
taking: NI0
Adding: NI11
taking: NI1
Adding: NI12
```

---

## Semaphores

A *semaphore* maintains a set of *permits* for restricting the number of threads that can access a limited resource. A thread attempting to acquire a permit when no permits are available blocks until some other thread releases a permit.

**Note** Semaphores whose current values can be incremented past 1 are known as *counting semaphores*, whereas semaphores whose current values can be only 0 or 1 are known as *binary semaphores* or *mutexes*. In either case, the current value cannot be negative.

The `java.util.concurrent.Semaphore` class implements this synchronizer and conceptualizes a semaphore as an object maintaining a set of permits. You initialize a semaphore by invoking the `Semaphore(int permits)` constructor where `permits` specifies the number of available permits. The resulting semaphore's *fairness policy* is set to `false` (unfair). Alternatively, you can invoke the `Semaphore(int permits, boolean fair)` constructor to also set the semaphore's fairness setting to `true` (fair).

## SEMAPHORES AND FAIRNESS

When the fairness setting is false, Semaphore makes no guarantees about the order in which threads acquire permits. In particular, *barging* is permitted; that is, a thread invoking `acquire()` can be allocated a permit ahead of a thread that has been waiting; logically the new thread places itself at the head of the queue of waiting threads. When `fair` is set to true, the semaphore guarantees that threads invoking any of the `acquire()` methods are selected to obtain permits in the order in which their invocation of those methods was processed (first-in, first-out; or FIFO). Because FIFO ordering necessarily applies to specific internal points of execution within these methods, it's possible for one thread to invoke `acquire()` before another thread, but reach the ordering point after the other thread and similarly upon return from the method. Also, the untimed `tryAcquire()` methods don't honor the fairness setting; they'll take any available permits.

Generally, semaphores used to control resource access should be initialized as `fair` to ensure that no thread is starved out from accessing a resource. When using semaphores for other kinds of synchronization control, the throughput advantages of unfair ordering often outweigh fairness considerations.

Semaphore also offers the following methods:

- `void acquire()`: Acquires a permit from this semaphore, blocking until one is available or the calling thread is interrupted. `InterruptedException` is thrown when interrupted.
- `void acquire(int permits)`: Acquires permits permits from this semaphore, blocking until they are available or the calling thread is interrupted. `InterruptedException` is thrown when interrupted; `IllegalArgumentException` is thrown when permits is less than zero.
- `void acquireUninterruptibly()`: Acquires a permit, blocking until one is available.
- `void acquireUninterruptibly(int permits)`: Acquires permits permits, blocking until they are all available. `IllegalArgumentException` is thrown when permits is less than zero.
- `int availablePermits()`: Returns the current number of available permits. This method is useful for debugging and testing.
- `int drainPermits()`: Acquires and returns a count of all permits that are immediately available.
- `int getQueueLength()`: Returns an estimate of the number of threads waiting to acquire permits. The returned value is only an estimate because the number of threads may change dynamically while this method traverses internal data structures. This method is designed for use in monitoring system state and not for synchronization control.
- `boolean hasQueuedThreads()`: Queries whether any threads are waiting to acquire permits. Because cancellations may occur at any time, a true return value doesn't guarantee that another thread will ever acquire permits. This method is designed primarily for use in monitoring system state. It returns true when there may be other waiting threads.

- `boolean isFair()`: Returns the fairness setting (true for fair and false for unfair).
- `void release()`: Releases a permit, returning it to the semaphore. The number of available permits is increased by one. If any threads are trying to acquire a permit, one thread is selected and given the permit that was just released. That thread is reenabled for thread scheduling purposes.
- `void release(int permits)`: Releases permits permits, returning them to the semaphore. The number of available permits is increased by permits. If any threads are trying to acquire permits, one is selected and given the permits that were just released. If the number of available permits satisfies that thread's request, the thread is reenabled for thread scheduling purposes; otherwise, the thread will wait until sufficient permits are available. If there are permits available after this thread's request has been satisfied, those permits are assigned to other threads trying to acquire permits. `IllegalArgumentException` is thrown when permits is less than zero.
- `String toString()`: Returns a string identifying this semaphore as well as its state. The state, in brackets, includes the string literal "Permits =" followed by the number of permits.
- `boolean tryAcquire()`: Acquires a permit from this semaphore but only when one is available at the time of invocation. Returns true when the permit was acquired. Otherwise, returns immediately with value false.
- `boolean tryAcquire(int permits)`: Acquires permits permits from this semaphore, but only when they are available at the time of invocation. Returns true when the permits were acquired. Otherwise, returns immediately with value false. `IllegalArgumentException` is thrown when permits is less than zero.
- `boolean tryAcquire(int permits, long timeout, TimeUnit unit)`: Like the previous method, but the calling thread waits when permits permits aren't available. The wait ends when the permits become available, the timeout expires, or the calling thread is interrupted, in which case `InterruptedException` is thrown.
- `boolean tryAcquire(long timeOut, TimeUnit unit)`: Like `tryAcquire(int permits)`, but the calling thread waits until a permit is available. The wait ends when the permit becomes available, the timeout expires, or the calling thread is interrupted, in which case `InterruptedException` is thrown.

Listing 10-5 expands on the “controlling access to a pool of items” Semaphore example presented in Semaphore's Javadoc.

*Listing 10-5. Using a Counting Semaphore to Control Access to a Pool of Items*

```
import java.util.concurrent.Executors;
import java.util.concurrent.ExecutorService;
import java.util.concurrent.Semaphore;
```

```
public class SemaphoreDemo
{
    public static void main(String[] args)
    {
        final Pool pool = new Pool();
        Runnable r = new Runnable()
        {
            @Override
            public void run()
            {
                String name = Thread.currentThread().getName();
                try
                {
                    while (true)
                    {
                        String item;
                        System.out.println(name + " acquiring " +
                            (item = pool.getItem()));
                        Thread.sleep(200 + (int) (Math.random() * 100));
                        System.out.println(name + " putting back " + item);
                        pool.putItem(item);
                    }
                }
                catch (InterruptedException ie)
                {
                    System.out.println(name + "interrupted");
                }
            }
        };
        ExecutorService[] executors = new ExecutorService[Pool.MAX_AVAILABLE+1];
        for (int i = 0; i < executors.length; i++)
        {
            executors[i] = Executors.newSingleThreadExecutor();
            executors[i].execute(r);
        }
    }
}

final class Pool
{
    public static final int MAX_AVAILABLE = 10;

    private Semaphore available = new Semaphore (MAX_AVAILABLE, true);

    private String[] items;

    private boolean[] used = new boolean[MAX_AVAILABLE];
}
```

```
Pool()
{
    items = new String[MAX_AVAILABLE];
    for (int i = 0; i < items.length; i++)
        items[i] = "I" + i;
}

String getItem() throws InterruptedException
{
    available.acquire();
    return getNextAvailableItem();
}

void putItem(String item)
{
    if (markAsUnused(item))
        available.release();
}

private synchronized String getNextAvailableItem()
{
    for (int i = 0; i < MAX_AVAILABLE; ++i)
    {
        if (!used[i])
        {
            used[i] = true;
            return items[i];
        }
    }
    return null; // not reached
}

private synchronized boolean markAsUnused(String item)
{
    for (int i = 0; i < MAX_AVAILABLE; ++i)
    {
        if (item == items[i])
        {
            if (used[i])
            {
                used[i] = false;
                return true;
            }
            else
                return false;
        }
    }
    return false;
}
}
```

Listing 10-5's main thread creates a resource pool, a runnable for repeatedly acquiring and putting back resources, and an array of executors. Each executor is told to execute the runnable.

Pool's `String getItem()` and `void putItem(String item)` methods obtain and return string-based resources. Before obtaining an item in `getItem()`, the calling thread must acquire a permit from the semaphore, which guarantees that an item is available for use. When the thread finishes with the item, it calls `putItem(String)`, which returns the item to the pool and then releases a permit to the semaphore, which lets another thread acquire that item.

No synchronization lock is held when `acquire()` is called because that would prevent an item from being returned to the pool. However, `String getNextAvailableItem()` and `boolean markAsUnused(String item)` are synchronized to maintain pool consistency. (The semaphore encapsulates the synchronization for restricting access to the pool separately from the synchronization that's required for maintaining pool consistency.)

Compile Listing 10-5:

```
javac SemaphoreDemo.java
```

When you run this application (`java SemaphoreDemo`), you'll observe a prefix of the output similar to the following:

---

```
pool-2-thread-1 acquiring I0
pool-4-thread-1 acquiring I1
pool-6-thread-1 acquiring I2
pool-8-thread-1 acquiring I3
pool-10-thread-1 acquiring I4
pool-1-thread-1 acquiring I5
pool-3-thread-1 acquiring I6
pool-5-thread-1 acquiring I7
pool-7-thread-1 acquiring I8
pool-9-thread-1 acquiring I9
pool-6-thread-1 putting back I2
pool-11-thread-1 acquiring I2
pool-2-thread-1 putting back I0
pool-6-thread-1 acquiring I0
pool-4-thread-1 putting back I1
pool-2-thread-1 acquiring I1
pool-1-thread-1 putting back I5
pool-4-thread-1 acquiring I5
pool-5-thread-1 putting back I7
pool-1-thread-1 acquiring I7
pool-8-thread-1 putting back I3
pool-5-thread-1 acquiring I3
pool-7-thread-1 putting back I8
pool-8-thread-1 acquiring I8
pool-10-thread-1 putting back I4
pool-7-thread-1 acquiring I4
pool-9-thread-1 putting back I9
pool-10-thread-1 acquiring I9
```

---



## Exploring the Concurrent Collections

In Chapter 9, I introduced you to the Collections Framework. This framework provides interfaces and classes that are located in the `java.util` package. Interfaces include `List`, `Set`, and `Map`; classes include `ArrayList`, `TreeSet`, and `HashMap`.

`ArrayList`, `TreeSet`, `HashMap`, and other implementation classes are not thread-safe. However, you can make them thread-safe by using the synchronized wrapper methods located in the `java.util.Collections` class. For example, you can pass an `ArrayList` instance to `Collections.synchronizedList()` to obtain a thread-safe variant of `ArrayList`.

Although they're often needed to simplify code in a multithreaded environment, there are a couple of problems with thread-safe collections:

- It's necessary to acquire a lock before iterating over a collection that might be modified by another thread during the iteration. If a lock isn't acquired and the collection is modified, it's highly likely that `java.util.ConcurrentModificationException` will be thrown. This happens because Collections Framework classes return *fail-fast iterators*, which are iterators that throw `ConcurrentModificationException` when collections are modified during iteration. Fail-fast iterators are often inconvenient to concurrent applications.
- Performance suffers when synchronized collections are accessed frequently from multiple threads. This performance problem ultimately impacts an application's *scalability*.

The Concurrency Utilities framework addresses these problems by introducing performant and highly scalable collections-oriented types, which are stored in the `java.util.concurrent` package. Its collections-oriented classes return *weakly consistent iterators*, which are iterators that have the following properties:

- An element that's removed after iteration starts but hasn't yet been returned via the iterator's `next()` method won't be returned.
- An element that's added after iteration starts may or may not be returned.
- No element is returned more than once during the collection's iteration, regardless of changes made to the collection during iteration.

The following list offers a short sample of concurrency-oriented collection types that you'll find in the `java.util.concurrent` package:

- `BlockingQueue` is a subinterface of `java.util.Queue` that also supports blocking operations that wait for the queue to become nonempty before retrieving an element and wait for space to become available in the queue before storing an element. Each of the `ArrayBlockingQueue`, `DelayQueue`, `LinkedBlockingQueue`, `PriorityBlockingQueue`, and `SynchronousQueue` classes implements this interface.
- `ConcurrentMap` is a subinterface of `java.util.Map` that declares additional atomic `putIfAbsent()`, `remove()`, and `replace()` methods. The `ConcurrentHashMap` class (the concurrent equivalent of `java.util.HashMap`), the `ConcurrentNavigableMap` class, and the `ConcurrentSkipListMap` class implement this interface.

Oracle's Javadoc for `BlockingQueue`, `ArrayBlockingQueue`, and other concurrency-oriented collection types identifies these types as part of the Collections Framework.

## Demonstrating `BlockingQueue` and `ArrayBlockingQueue`

`BlockingQueue`'s Javadoc reveals the heart of a producer-consumer application that's vastly simpler than the equivalent application shown in Chapter 7's Listing 7-23 because it doesn't have to deal with synchronization. Listing 10-6 uses `BlockingQueue` and its `ArrayBlockingQueue` implementation class in a high-level producer-consumer equivalent.

*Listing 10-6. The Blocking Queue Equivalent of Listing 7-23's PC Application*

```
import java.util.concurrent.ArrayBlockingQueue;
import java.util.concurrent.BlockingQueue;
import java.util.concurrent.ExecutorService;
import java.util.concurrent.Executors;

public class PC
{
    public static void main(String[] args)
    {
        final BlockingQueue<Character> bq;
        bq = new ArrayBlockingQueue<Character>(26);
        final ExecutorService executor = Executors.newFixedThreadPool(2);
        Runnable producer;
        producer = new Runnable()
        {
            @Override
            public void run()
            {
                for (char ch = 'A'; ch <= 'Z'; ch++)
                {
                    try
                    {
                        bq.put(ch);
                        System.out.println(ch + " produced by producer.");
                    }
                    catch (InterruptedException ie)
                    {
                        assert false;
                    }
                }
            }
        };
    }
};
```

```

executor.execute(producer);
Runnable consumer;
consumer = new Runnable()
{
    @Override
    public void run()
    {
        char ch = '\0';
        do
        {
            try
            {
                ch = bq.take();
                System.out.println(ch + " consumed by consumer.");
            }
            catch (InterruptedException ie)
            {
                assert false;
            }
        }
        while (ch != 'Z');
        executor.shutdownNow();
    }
};
executor.execute(consumer);
}
}

```

Listing 10-6 uses `BlockingQueue`'s `put()` and `take()` methods, respectively, to put an object on the blocking queue and to remove an object from the blocking queue. `put()` blocks when there's no room to put an object; `take()` blocks when the queue is empty.

Although `BlockingQueue` ensures that a character is never consumed before it's produced, this application's output may indicate otherwise. For example, here's a portion of the output from one run:

---

```

Y consumed by consumer.
Y produced by producer.
Z consumed by consumer.
Z produced by producer.

```

---

Chapter 7's PC application in Listing 7-24 overcame this incorrect output order by introducing an extra layer of synchronization around `setSharedChar()/System.out.println()` and an extra layer of synchronization around `getSharedChar()/System.out.println()`. Later in this chapter, I will show you an alternative in the form of locks.

## Learning More About ConcurrentHashMap

Let's now consider `ConcurrentHashMap`. This class behaves like `HashMap` but has been designed to work in multithreaded contexts without the need for explicit synchronization. For example, you often need to check if a map contains a specific value and, when this value is absent, put this value into the map:

```
if (!map.containsKey("some string-based key"))
    map.put("some string-based key", "some string-based value");
```

Although this code is simple and appears to do the job, it isn't thread-safe. Between the call to `map.containsKey()` and `map.put()`, another thread could insert this entry, which would then be overwritten. To fix this problem, you would need to explicitly synchronize this code, which I demonstrate here:

```
synchronized(map)
{
    if (!map.containsKey("some string-based key"))
        map.put("some string-based key", "some string-based value");
}
```

The problem with this approach is that you've locked the entire map for read and write operations while checking for key existence and adding the entry to the map when the key doesn't exist. This locking affects performance when many threads are trying to access the map.

The generic `ConcurrentHashMap<V>` class addresses this problem by providing the `V putIfAbsent(K key, V value)` method, which introduces a key/value entry into the map when key is absent. This method is equivalent to the following code fragment but offers better performance:

```
synchronized(map)
{
    if (!map.containsKey(key))
        return map.put(key, value);
    else
        return map.get(key);
}
```

Using `putIfAbsent()`, the earlier code fragment translates into the following simpler code fragment:

```
map.putIfAbsent("some string-based key", "some string-based value");
```

## Exploring the Locking Framework

The `java.util.concurrent.locks` package provides a framework of interfaces and classes for locking and waiting for conditions in a manner that's distinct from built-in synchronization and `java.lang.Object`'s wait/notification mechanism. The Locking Framework improves on synchronization and wait/notification by offering capabilities such as lock polling and timed waits.

## SYNCHRONIZED AND LOW-LEVEL LOCKING

Java supports synchronization so that threads can safely update shared variables and ensure that a thread's updates are visible to other threads. You leverage synchronization in your code by marking methods or code blocks with the `synchronized` keyword. The Java virtual machine (JVM) supports synchronization via monitors and the associated `monitorenter` and `monitorexit` JVM instructions.

Every Java object is associated with a *monitor*, which is a *mutual exclusion* (letting only one thread at a time execute in a critical section) construct that prevents multiple threads from concurrently executing in a critical section. Before a thread can enter a critical section, it's required to lock the monitor. If the monitor is already locked, the thread blocks until the monitor is unlocked (by another thread leaving the critical section).

When a thread locks a monitor, the values of shared variables that are stored in main memory are read into the copies of these variables that are stored in a thread's *working memory* (also known as *local memory* or *cache memory*). This action ensures that the thread will work with the most recent values of these variables and not stale values, and it is known as *visibility*. The thread proceeds to work with its copies of these shared variables. When the thread unlocks the monitor while leaving the critical section, the values in its copies of shared variables are written back to main memory, which lets the next thread that enters the critical section access the most recent values of these variables. (The `volatile` keyword addresses visibility only.)

The Locking Framework includes the often-used `Lock`, `ReentrantLock`, `Condition`, `ReadWriteLock`, and `ReentrantReadWriteLock` types, which I discuss in this section.

## Lock

The `Lock` interface offers more extensive locking operations than can be obtained via the locks associated with monitors. For example, you can immediately back out of a lock-acquisition attempt when a lock isn't available. This interface declares the following methods:

- `void lock()`: Acquires the lock. When the lock isn't available, the calling thread is forced to wait until it becomes available.
- `void lockInterruptibly()`: Acquires the lock unless the calling thread is interrupted. When the lock isn't available, the calling thread is forced to wait until it becomes available or the thread is interrupted, which results in this method throwing `InterruptedException`.
- `Condition newCondition()`: Returns a new `Condition` instance that's bound to this `Lock` instance. This method throws `java.lang.UnsupportedOperationException` when the `Lock` implementation doesn't support conditions.
- `boolean tryLock()`: Acquires the lock when it's available at the time this method is invoked. The method returns `true` when the lock is acquired and `false` when the lock isn't acquired.

- `boolean tryLock(long time, TimeUnit unit)`: Acquires the lock when it's available within the specified waiting time and the calling thread isn't interrupted. When the lock isn't available, the calling thread is forced to wait until it becomes available within the waiting time or the thread is interrupted, which results in this method throwing `InterruptedException`.
- `void unlock()`: Releases the lock.

Acquired locks must be released. In the context of synchronized methods and statements, and the implicit monitor lock associated with every object, all lock acquisition and release occurs in a block-structured manner. When multiple locks are acquired, they're released in the opposite order and all locks are released in the same lexical scope in which they were acquired.

Lock acquisition and release in the context of `Lock` interface implementations can be more flexible. For example, some algorithms for traversing concurrently accessed data structures require the use of *hand-over-hand* or *chain locking*: you acquire the lock of node A, then node B, then release A and acquire C, then release B and acquire D and so on. Implementations of the `Lock` interface enable the use of such techniques by allowing a lock to be acquired and released in different scopes, and by allowing multiple locks to be acquired and released in any order.

With this increased flexibility comes additional responsibility. The absence of block-structured locking removes the automatic release of locks that occurs with synchronized methods and statements. As a result, you should typically employ the following idiom for lock acquisition and release:

```
Lock l = ...; // ... is a placeholder for code that obtains the lock
l.lock();
try
{
    // access the resource protected by this lock
}
catch (Exception ex)
{
    // restore invariants
}
finally
{
    l.unlock();
}
```

This idiom ensures that an acquired lock will always be released.

**Note** All `Lock` implementations are required to enforce the same memory synchronization semantics as provided by the built-in monitor lock.

## ReentrantLock

Lock is implemented by the `ReentrantLock` class, which describes a reentrant mutual exclusion lock. This lock is associated with a hold count. When a thread holds the lock and reacquires the lock by invoking `lock()`, `lockUninterruptibly()`, or one of the `tryLock()` methods, the hold count is increased by 1. When the thread invokes `unlock()`, the hold count is decremented by 1. The lock is released when this count reaches 0.

`ReentrantLock` offers the same concurrency and memory semantics as the implicit monitor lock that's accessed via synchronized methods and statements. However, it has extended capabilities and offers better performance under high *thread contention* (threads frequently asking to acquire a lock that's already held by another thread). When many threads attempt to access a shared resource, the JVM spends less time scheduling these threads and more time executing them.

You initialize a `ReentrantLock` instance by invoking either of the following constructors:

- `ReentrantLock()`: Creates an instance of `ReentrantLock`. This constructor is equivalent to `ReentrantLock(false)`.
- `ReentrantLock(boolean fair)`: Creates an instance of `ReentrantLock` with the specified fairness policy. Pass `true` to `fair` when this lock should use a fair ordering policy: under contention, the lock would favor granting access to the longest-waiting thread.

`ReentrantLock` implements `Lock`'s methods. However, its implementation of `unlock()` throws `java.lang.IllegalMonitorStateException` when the calling thread doesn't hold the lock. Also, `ReentrantLock` provides its own methods. For example, `boolean isFair()` returns the fairness policy and `boolean isHeldByCurrentThread()` returns `true` when the lock is held by the current thread.

Listing 10-7 demonstrates `Lock` and `ReentrantLock` in a variation of Listing 10-6 that ensures that the output is never shown in incorrect order (a consumed message appearing before a produced message). (This listing is the Concurrency Utilities counterpart to Chapter 7's Listing 7-24.)

### *Listing 10-7. Achieving Synchronization in Terms of Locks*

```
import java.util.concurrent.ArrayBlockingQueue;
import java.util.concurrent.BlockingQueue;
import java.util.concurrent.ExecutorService;
import java.util.concurrent.Executors;

import java.util.concurrent.locks.Lock;
import java.util.concurrent.locks.ReentrantLock;

public class PC
{
    public static void main(String[] args)
    {
        final Lock lock = new ReentrantLock();
        final BlockingQueue<Character> bq;
        bq = new ArrayBlockingQueue<Character>(26);
        final ExecutorService executor = Executors.newFixedThreadPool(2);
        Runnable producer;
```

```
producer = new Runnable()
{
    @Override
    public void run()
    {
        for (char ch = 'A'; ch <= 'Z'; ch++)
        {
            try
            {
                lock.lock();
                try
                {
                    while (!bq.offer(ch))
                    {
                        lock.unlock();
                        Thread.sleep(50);
                        lock.lock();
                    }
                    System.out.println(ch + " produced by producer.");
                }
                catch (InterruptedException ie)
                {
                    assert false;
                }
            }
            finally
            {
                lock.unlock();
            }
        }
    }
};
executor.execute(producer);
Runnable consumer;
consumer = new Runnable()
{
    @Override
    public void run()
    {
        char ch = '\0';
        do
        {
            try
            {
                lock.lock();
                try
                {
```



```

        Character c;
        while ((c = bq.poll()) == null)
        {
            lock.unlock();
            Thread.sleep(50);
            lock.lock();
        }
        ch = c; // unboxing behind the scenes
        System.out.println(ch + " consumed by consumer.");
    }
    catch (InterruptedException ie)
    {
        assert false;
    }
}
finally
{
    lock.unlock();
}
}
while (ch != 'Z');
executor.shutdownNow();
};
}
executor.execute(consumer);
}
}

```

Listing 10-7 uses Lock’s `lock()` and `unlock()` methods to obtain and release a lock. When a thread calls `lock()` and the lock is unavailable, the thread is disabled (and cannot be scheduled) until the lock becomes available.

This listing also uses `BlockingQueue`’s `offer()` method instead of `put()` to store an object in the blocking queue and its `poll()` method instead of `take()` to retrieve an object from the queue. These alternative methods are used because they don’t block.

If I had used `put()` and `take()`, this application would have deadlocked in the following scenario:

1. The consumer thread acquires the lock via its `lock.lock()` call.
2. The producer thread attempts to acquire the lock via its `lock.lock()` call and is disabled because the consumer thread has already acquired the lock.
3. The consumer thread calls `take()` to obtain the next `java.lang.Character` object from the queue.
4. Because the queue is empty, the consumer thread must wait.
5. The consumer thread doesn’t give up the lock that the producer thread requires before waiting, so the producer thread also continues to wait.

Compile this source code as follows:

```
javac PC.java
```

When you run this application (`java PC`), you'll discover that, as with Listing 7-24's PC application, it never outputs a consuming message before a producing message for the same item.

## Condition

The Condition interface factors out Object's wait and notification methods (`wait()`, `notify()`, and `notifyAll()`) into distinct condition objects to give the effect of having multiple wait-sets per object, by combining them with the use of arbitrary Lock implementations. Where Lock replaces synchronized methods and statements, Condition replaces Object's wait/notification methods.

**Note** A Condition instance is intrinsically bound to a lock. To obtain a Condition instance for a particular Lock instance, use Lock's `newCondition()` method.

Condition declares the following methods:

- `void await()`: Forces the calling thread to wait until it's signaled or interrupted.
- `boolean await(long time, TimeUnit unit)`: Forces the calling thread to wait until it's signaled or interrupted, or until the specified waiting time elapses.
- `long awaitNanos(long nanosTimeout)`: Forces the current thread to wait until it's signaled or interrupted, or until the specified waiting time elapses.
- `void awaitUninterruptibly()`: Forces the current thread to wait until it's signaled.
- `boolean awaitUntil(Date deadline)`: Forces the current thread to wait until it's signaled or interrupted, or until the specified deadline elapses.
- `void signal()`: Wakes up one waiting thread.
- `void signalAll()`: Wakes up all waiting threads.

Listing 10-8 revisits the producer-consumer example to show you how it can be written to take advantage of conditions.

### *Listing 10-8. Achieving Synchronization in Terms of Locks and Conditions*

```
import java.util.concurrent.locks.Condition;
import java.util.concurrent.locks.Lock;
import java.util.concurrent.locks.ReentrantLock;
```

```
public class PC
{
    public static void main(String[] args)
    {
        Shared s = new Shared();
        new Producer(s).start();
        new Consumer(s).start();
    }
}

class Shared
{
    // Fields c and available are volatile so that writes to them are visible to
    // the various threads. Fields lock and condition are final so that they're
    // initial values are visible to the various threads. (The Java memory model
    // promises that, after a final field has been initialized, any thread will
    // see the same [correct] value.)

    private volatile char c;

    private volatile boolean available;

    private final Lock lock;

    private final Condition condition;

    Shared()
    {
        c = '\u0000';
        available = false;
        lock = new ReentrantLock();
        condition = lock.newCondition();
    }

    Lock getLock()
    {
        return lock;
    }

    char getSharedChar()
    {
        lock.lock();
        try
        {
            while (!available)
                try
                {
                    condition.await();
                }
        }
    }
}
```

```
        catch (InterruptedException ie)
        {
            ie.printStackTrace();
        }
        available = false;
        condition.signal();
    }
    finally
    {
        lock.unlock();
        return c;
    }
}

void setSharedChar(char c)
{
    lock.lock();
    try
    {
        while (available)
            try
            {
                condition.await();
            }
            catch (InterruptedException ie)
            {
                ie.printStackTrace();
            }
        this.c = c;
        available = true;
        condition.signal();
    }
    finally
    {
        lock.unlock();
    }
}
}

class Producer extends Thread
{
    // l is final because it's initialized on the main thread and accessed on the
    // producer thread.

    private final Lock l;

    // s is final because it's initialized on the main thread and accessed on the
    // producer thread.

    private final Shared s;
```

```

Producer(Shared s)
{
    this.s = s;
    l = s.getLock();
}

@Override
public void run()
{
    for (char ch = 'A'; ch <= 'Z'; ch++)
    {
        l.lock();
        s.setSharedChar(ch);
        System.out.println(ch + " produced by producer.");
        l.unlock();
    }
}
}

class Consumer extends Thread
{
    // l is final because it's initialized on the main thread and accessed on the
    // consumer thread.

    private final Lock l;

    // s is final because it's initialized on the main thread and accessed on the
    // consumer thread.

    private final Shared s;

    Consumer(Shared s)
    {
        this.s = s;
        l = s.getLock();
    }

    @Override
    public void run()
    {
        char ch;
        do
        {
            l.lock();
            ch = s.getSharedChar();
            System.out.println(ch + " consumed by consumer.");
            l.unlock();
        }
        while (ch != 'Z');
    }
}
}

```

Listing 10-8 is similar to Listing 7-24's PC application. However, it replaces synchronized and wait/notification with locks and conditions.

PC's `main()` method instantiates the `Shared`, `Producer`, and `Consumer` classes. The `Shared` instance is passed to the `Producer` and `Consumer` constructors, and these threads are then started.

The `Producer` and `Consumer` constructors are called on the main thread. Because the producer and consumer threads also access the `Shared` instance, this instance must be visible to these threads (especially when these threads run on different cores). In each of `Producer` and `Consumer`, I accomplish this task by declaring `s` to be `final`. I could have declared this field to be `volatile`, but `volatile` suggests additional writes to the field and `s` shouldn't be changed after being initialized.

Check out `Shared`'s constructor. Notice that it creates a lock via `lock = new ReentrantLock();`, and creates a condition associated with this lock via `condition = lock.newCondition();`. This lock is made available to the producer and consumer threads via the `Lock getLock()` method.

The producer thread invokes `Shared`'s `void setSharedChar(char c)` method to generate a new character and then outputs a message identifying the produced character. This method locks the previously created `Lock` object and enters a while loop that repeatedly tests variable `available`, which is true when a produced character is available for consumption.

While `available` is true, the producer invokes the condition's `await()` method to wait for `available` to become false. The consumer signals the condition to wake up the producer when it has consumed the character. (I use a loop instead of an if statement because spurious wakeups are possible and `available` might still be true.)

After leaving its loop, the producer thread records the new character, assigns true to `available` to indicate that a new character is available for consumption, and signals the condition to wake up a waiting consumer. Lastly, it unlocks the lock and exits `setSharedChar()`.

**Note** I lock the `setSharedChar()/System.out.println()` block in `Producer`'s `run()` method and the `getSharedChar()/System.out.println()` block in `Consumer`'s `run()` method to prevent the application from outputting consuming messages before producing messages, even though characters are produced before they're consumed.

The behavior of the consumer thread and `getSharedChar()` method is similar to what I've just described for the producer thread and `setSharedChar()` method.

**Note** I didn't use the `try/finally` idiom for ensuring that a lock is disposed of in `Producer`'s and `Consumer`'s `run()` methods, because an exception isn't thrown from this context.

Compile this source code as follows:

```
javac PC.java
```

Run this application (java PC) and you'll observe output identical to the following prefix of the output, which indicates *lockstep synchronization* (the producer thread doesn't produce an item until it's consumed and the consumer thread doesn't consume an item until it's produced):

---

```
A produced by producer.  
A consumed by consumer.  
B produced by producer.  
B consumed by consumer.  
C produced by producer.  
C consumed by consumer.  
D produced by producer.  
D consumed by consumer.
```

---

## ReadWriteLock

Situations arise where data structures are read more often than they're modified. For example, you may have created an online dictionary of word definitions that many threads will read concurrently, whereas a single thread may add new definitions or update existing definitions. The Locking Framework provides a read-write locking mechanism for these situations that yields greater concurrency when reading and the safety of exclusive access when writing. This mechanism is based on the `ReadWriteLock` interface.

`ReadWriteLock` maintains a pair of locks: one lock for read-only operations and one lock for write operations. Multiple reader threads may hold the read lock simultaneously, as long as there are no writers. The write lock is exclusive: only a single thread can modify shared data. (The lock that's associated with the `synchronized` keyword is also exclusive.)

`ReadWriteLock` declares the following methods:

- Lock `readLock()`: Returns the lock that's used for reading.
- Lock `writeLock()`: Returns the lock that's used for writing.

## ReentrantReadWriteLock

`ReadWriteLock` is implemented by the `ReentrantReadWriteLock` class, which describes a reentrant read-write lock with similar semantics to `ReentrantLock`.

You initialize a `ReentrantReadWriteLock` instance by invoking either of the following constructors:

- `ReentrantReadWriteLock()`: Creates an instance of `ReentrantReadWriteLock`. This constructor is equivalent to `ReentrantReadWriteLock(false)`.
- `ReentrantReadWriteLock(boolean fair)`: Creates an instance of `ReentrantReadWriteLock` with the specified fairness policy. Pass `true` to `fair` when this lock should use a fair ordering policy.

**Note** For the fair ordering policy, when the currently held lock is released, either the longest-waiting single writer thread will be assigned the write lock or, when there's a group of reader threads waiting longer than all waiting writer threads, that group will be assigned the read lock.

A thread that tries to acquire a fair read lock (non-reentrantly) will block when the write lock is held or there's a waiting writer thread. The thread will not acquire the read lock until after the oldest currently waiting writer thread has acquired and released the write lock. If a waiting writer abandons its wait, leaving one or more reader threads as the longest waiters in the queue with the write lock free, those readers will be assigned the read lock.

A thread that tries to acquire a fair write lock (non-reentrantly) will block unless both the read lock and write lock are free (which implies no waiting threads). (The nonblocking `tryLock()` methods don't honor this fair setting and will immediately acquire the lock if possible, regardless of waiting threads.)

After instantiating this class, you would invoke the following methods to obtain the read and write locks:

- `ReentrantReadWriteLock.ReadLock readLock()`: Returns the lock used for reading.
- `ReentrantReadWriteLock.WriteLock writeLock()`: Returns the lock used for writing.

Each of the nested `ReadLock` and `WriteLock` classes implements the `Lock` interface and declares its own methods. Furthermore, `ReentrantReadWriteLock` declares additional methods such as the following pair:

- `int getReadHoldCount()`: Returns the number of reentrant read holds on this lock by the calling thread, which is 0 when the read lock isn't held by the calling thread. A reader thread has a hold on a lock for each lock action that's not matched by an unlock action.
- `int getWriteHoldCount()`: Returns the number of reentrant write holds on this lock by the calling thread, which is 0 when the write lock isn't held by the calling thread. A writer thread has a hold on a lock for each lock action that's not matched by an unlock action.

To demonstrate `ReadWriteLock` and `ReentrantReadWriteLock`, Listing 10-9 presents an application whose writer thread populates a dictionary of word/definition entries while a reader thread continually accesses entries at random and outputs them.

*Listing 10-9. Using `ReadWriteLock` to Satisfy a Dictionary Application's Reader and Writer Threads*

```
import java.util.HashMap;
import java.util.Map;

import java.util.concurrent.Executors;
import java.util.concurrent.ExecutorService;
```



```
import java.util.concurrent.locks.Lock;
import java.util.concurrent.locks.ReadWriteLock;
import java.util.concurrent.locks.ReentrantReadWriteLock;

public class Dictionary
{
    public static void main(String[] args)
    {
        final String[] words =
        {
            "hypocalcemia",
            "prolixity",
            "assiduous",
            "indefatigable",
            "castellan"
        };

        final String[] definitions =
        {
            "a deficiency of calcium in the blood",
            "unduly prolonged or drawn out",
            "showing great care, attention, and effort",
            "able to work or continue for a lengthy time without tiring",
            "the governor or warden of a castle or fort"
        };

        final Map<String, String> dictionary = new HashMap<String, String>();

        ReadWriteLock rwl = new ReentrantReadWriteLock(true);
        final Lock rlock = rwl.readLock();
        final Lock wlock = rwl.writeLock();

        Runnable writer = new Runnable()
        {
            @Override
            public void run()
            {
                for (int i = 0; i < words.length; i++)
                {
                    wlock.lock();

                    try
                    {
                        dictionary.put(words[i], definitions[i]);
                        System.out.println("writer storing " +
                            words[i] + " entry");
                    }
                    finally
                    {
                        wlock.unlock();
                    }
                }
            }
        };
    }
}
```

```

        try
        {
            Thread.sleep((int) Math.random() * 500);
        }
        catch (InterruptedException ie)
        {
            System.err.println("writer interrupted");
        }
    }
}
};
ExecutorService es = Executors.newFixedThreadPool(1);
es.submit(writer);

Runnable reader = new Runnable()
{
    @Override
    public void run()
    {
        while (true)
        {
            rlock.lock();

            try
            {
                int i = (int) (Math.random() * words.length);
                System.out.println("reader accessing " +
                    words[i] + ": " +
                    dictionary.get(words[i])
                    + " entry");
            }
            finally
            {
                rlock.unlock();
            }
        }
    }
};
es = Executors.newFixedThreadPool(1);
es.submit(reader);
}
}

```

Listing 10-9's main thread first creates the words and definitions arrays of strings, which are declared `final` because they will be accessed from anonymous classes. After creating a map in which to store word/definition entries, it obtains a reentrant read/write lock and accesses the reader and writer locks.

A runnable for the writer thread is now created. Its `run()` method iterates over the words array. Each of the iterations locks the writer lock. When this method returns, the writer thread has the exclusive writer lock and can update the map. It does so by invoking the map's `put()` method. After outputting a message to identify the added word, the writer thread releases the lock and sleeps for a random

amount of time to give the appearance of performing other work. An executor based on a thread pool is obtained and used to invoke the writer thread's runnable.

A runnable for the reader thread is subsequently created. Its `run()` method repeatedly obtains the read lock, accesses a random entry in the map, outputs this entry, and unlocks the read lock. An executor based on a thread pool is obtained and used to invoke the reader thread's runnable.

Although I could have avoided the idiom for lock acquisition and release because an exception isn't thrown, I specified `try/finally` for good form.

Compile Listing 10-9 as follows:

```
javac Dictionary
```

Run this application (`java Dictionary`) and you should observe output that's similar to the following prefix of output that I observed from one execution:

---

```
writer storing hypocalcemia entry
reader accessing hypocalcemia: a deficiency of calcium in the blood entry
reader accessing indefatigable: null entry
reader accessing indefatigable: null entry
reader accessing castellan: null entry
writer storing prolixity entry
reader accessing hypocalcemia: a deficiency of calcium in the blood entry
writer storing assiduous entry
reader accessing indefatigable: null entry
reader accessing castellan: null entry
reader accessing assiduous: showing great care, attention, and effort entry
reader accessing hypocalcemia: a deficiency of calcium in the blood entry
writer storing indefatigable entry
reader accessing indefatigable: able to work or continue for a lengthy time without tiring entry
writer storing castellan entry
reader accessing indefatigable: able to work or continue for a lengthy time without tiring entry
reader accessing prolixity: unduly prolonged or drawn out entry
reader accessing assiduous: showing great care, attention, and effort entry
reader accessing assiduous: showing great care, attention, and effort entry
reader accessing castellan: the governor or warden of a castle or fort entry
reader accessing hypocalcemia: a deficiency of calcium in the blood entry
reader accessing prolixity: unduly prolonged or drawn out entry
reader accessing prolixity: unduly prolonged or drawn out entry
```

---

## Exploring Atomic Variables

The `java.util.concurrent.atomic` package provides a small toolkit of classes that support lock-free, thread-safe operations on single variables. The classes in this package extend the notion of volatile values, fields, and array elements to those that also provide an atomic conditional update so that external synchronization isn't required.

Some of the classes located in this package are described below:

- `AtomicBoolean`: A boolean value that may be updated atomically.
- `AtomicInteger`: An int value that may be updated atomically.
- `AtomicIntegerArray`: An int array whose elements may be updated atomically.
- `AtomicLong`: A long value that may be updated atomically.
- `AtomicLongArray`: A long array whose elements may be updated atomically.
- `AtomicReference`: An object reference that may be updated atomically.
- `AtomicReferenceArray`: An object reference array whose elements may be updated atomically.

Listing 7-19 declared a small utility class named `ID` for returning unique long integer identifiers via `ID`'s `getNextID()` class method. Because this method wasn't synchronized, multiple threads could obtain the same identifier. Listing 10-10 fixes this problem by including reserved word `synchronized` in the method header.

*Listing 10-10. Returning Unique Identifiers in a Thread-Safe Manner via `synchronized`*

```
class ID
{
    private static long nextID = 0;
    static synchronized long getNextID()
    {
        return nextID++;
    }
}
```

Although `synchronized` is appropriate for this example, excessive use of this reserved word in more complex classes can lead to deadlock, starvation, or other problems. Listing 10-11 shows you how to avoid these assaults on a concurrent application's *liveness* (the ability to execute in a timely manner) by replacing `synchronized` with an atomic variable.

*Listing 10-11. Returning Unique IDs in a Thread-Safe Manner via `AtomicLong`*

```
import java.util.concurrent.atomic.AtomicLong;

class ID
{
    private static AtomicLong nextID = new AtomicLong(0);
    static long getNextID()
    {
        return nextID.getAndIncrement();
    }
}
```

In Listing 10-11, I've converted `nextID` from a `long` to an `AtomicLong` instance, initializing this object to 0. I've also refactored the `getNextID()` method to call `AtomicLong`'s `getAndIncrement()` method, which increments the `AtomicLong` instance's internal long integer variable by 1 and returns the previous value in one indivisible step.

## Improving Performance with the Concurrency Utilities

Java's low-level synchronization mechanism, which enforces *mutual exclusion* (the thread holding the lock that guards a set of variables has exclusive access to them) and *visibility* (changes to the guarded variables become visible to other threads that subsequently acquire the lock), impacts hardware utilization and scalability in the following ways:

- *Contended synchronization* (multiple threads constantly competing for a lock) is expensive and throughput suffers as a result. This expense is caused mainly by the frequent *context switching* that occurs. Each context switch operation can take many processor cycles to complete. In contrast, modern JVMs make *uncontended synchronization* inexpensive.
- When a thread holding a lock is delayed (because of a scheduling delay, for example), no thread that requires that lock makes any progress; the hardware isn't utilized as well as it might be.

Although you might believe that you can use `volatile` as a synchronization alternative, this won't work. `Volatile` variables only solve the visibility problem. They cannot be used to implement safely the atomic read-modify-write sequences that are necessary for implementing thread-safe counters and other entities that require mutual exclusion. However, there is an alternative that's responsible for the performance gains offered by the Concurrency Utilities over equivalent features in the Threads API. This alternative is known as Compare-and-Swap.

*Compare-and-Swap (CAS)* is the generic term for an uninterruptible microprocessor-specific instruction that reads a memory location, compares the read value with an expected value, and stores a new value in the memory location when the read value matches the expected value. Otherwise, nothing is done. Modern microprocessors offer variations of CAS. For example, Intel microprocessors provide the `cmpxchg` family of instructions, whereas the older PowerPC microprocessors provide equivalent load-link (such as `lwarx`) and store-conditional (such as `stwcx`) instructions.

CAS supports atomic read-modify-write sequences. You typically use CAS as follows:

1. Read value  $x$  from address  $A$ .
2. Perform a multistep computation on  $x$  to derive a new value  $y$ .
3. Use CAS to change the value of  $A$  from  $x$  to  $y$ . CAS succeeds when  $A$ 's value hasn't changed while performing these steps.

To understand CAS's benefit, consider Listing 10-10's `ID` class, which returns a unique identifier. Because this class declares its `getNextID()` method `synchronized`, high contention for the monitor lock results in excessive context switching that can delay all of the threads and result in an application that doesn't scale well.

Assume the existence of a CAS class that stores an int-based value in `value`. Furthermore, it offers atomic methods `int getValue()` for returning value and `int compareAndSwap(int expectedValue, int newValue)` for implementing CAS. Behind the scenes, CAS relies on the Java Native Interface (see Chapter 16) to access the microprocessor-specific CAS instruction.

The `compareAndSwap()` method executes the following instruction sequence atomically:

```
int readValue = value;           // Obtain the stored value.
if (readValue == expectedValue) // If stored value not modified ...
    value = newValue;           // ... change to new value.
return readValue;               // Return value before a potential change.
```

Listing 10-12 presents a new version of ID that uses the CAS class to obtain a unique identifier in a highly performant manner.

*Listing 10-12. Returning Unique IDs in a Thread-Safe Manner via CAS*

```
class ID
{
    private static CAS value = new CAS(0);

    static long getNextID()
    {
        int curValue = value.getValue();
        while (value.compareAndSwap(curValue, curValue + 1) != curValue)
            curValue = value.getValue();
        return curValue - 1;
    }
}
```

ID encapsulates a CAS instance initialized to int-value 0 and declares a `getNextID()` method for retrieving the current identifier value and then incrementing this value with help from this instance. After retrieving the instance's current value, `getNextID()` repeatedly invokes `compareAndSwap()` until `curValue`'s value hasn't changed (by another thread). This method is then free to change this value, after which it returns the previous value. When no lock is involved, contention is avoided along with excessive context switching. Performance improves and the code is more scalable.

As an example of how CAS improves the Concurrency Utilities, consider `ReentrantLock`. This class offers better performance than `synchronized` under high thread contention. To boost performance, `ReentrantLock`'s synchronization is managed by a subclass of the abstract `java.util.concurrent.locks.AbstractQueuedSynchronizer` class. In turn, this class leverages the undocumented `sun.misc.Unsafe` class and its `compareAndSwapInt()` CAS method.

The atomic variable classes also leverage CAS. Furthermore, they provide a method that has the following form:

```
boolean compareAndSet(expectedValue, updateValue)
```

This method (which varies in argument types across different classes) atomically sets a variable to the `updateValue` when it currently holds the `expectedValue`, reporting true on success.

---

**EXERCISES**

The following exercises are designed to test your understanding of Chapter 10's content.

1. Define Concurrency Utilities.
2. Identify the packages in which Concurrency Utilities types are stored.
3. Define task.
4. Define executor.
5. Identify the Executor interface's limitations.
6. How are Executor's limitations overcome?
7. What differences exist between Runnable's run() method and Callable's call() method?
8. True or false: You can throw checked and unchecked exceptions from Runnable's run() method but can only throw unchecked exceptions from Callable's call() method.
9. Define future.
10. Describe the Executors class's newFixedThreadPool() method.
11. Define synchronizer.
12. Identify and describe four commonly used synchronizers.
13. What concurrency-oriented extensions to the Collections Framework are provided by the Concurrency Utilities?
14. Define lock.
15. What is the biggest advantage that Lock objects hold over the implicit locks that are obtained when threads enter critical sections (controlled via the synchronized reserved word)?
16. How do you obtain a Condition instance for use with a particular Lock instance?
17. Define atomic variable.
18. What does the AtomicIntegerArray class describe?
19. True or false: volatile supports atomic read-modify-write sequences.
20. What's responsible for the performance gains offered by the Concurrency Utilities?
21. Listing 7-13 in Chapter 7 presented a simple CountingThreads application. Refactor this application to work with Executors and ExecutorService.
22. When you execute the previous exercise's CountingThreads application, you'll observe output that identifies the threads via names such as pool-1-thread-1. Modify CountingThreads so that you observe names A and B. Hint: You'll need to use ThreadFactory.
23. Listing 7-25's DeadlockDemo class demonstrates deadlock in the context of the synchronized primitive. Create an equivalent application that demonstrates deadlock via the Lock interface and ReentrantLock class. Then create an application that uses these same types to prevent deadlock.
24. Convert the following expressions to their atomic variable equivalents:  

```
int total = ++counter;  
int total = counter--;
```

## Summary

The low-level Threads API lets you create multithreaded applications that offer better performance and responsiveness over their single-threaded counterparts. However, performance issues that affect an application's scalability and other problems resulted in Java 5's introduction of the Concurrency Utilities.

The Concurrency Utilities organizes its many types into three packages: `java.util.concurrent`, `java.util.concurrent.atomic`, and `java.util.concurrent.locks`. Basic types, such as executors, thread pools, and concurrent hashmaps, are stored in `java.util.concurrent`, classes that support lock-free, thread-safe programming on single variables are stored in `java.util.concurrent.atomic`, and types for locking and waiting on conditions are stored in `java.util.concurrent.locks`.

An executor decouples task submission from task-execution mechanics and is described by the `Executor`, `ExecutorService`, and `ScheduledExecutorService` interfaces. You obtain an executor by calling one of the utility methods in the `Executors` class. Executors are associated with callables and futures.

A synchronizer facilitates common forms of synchronization. Countdown latches, cyclic barriers, exchangers, and semaphores are commonly used synchronizers.

A concurrent collection is an extension to the Collections Framework. The `BlockingQueue` and `ConcurrentMap` interfaces along with the `ArrayBlockingQueue` and `ConcurrentHashMap` classes are examples.

The `java.util.concurrent.locks` package provides a framework of interfaces and classes for locking and waiting for conditions in a manner that's distinct from built-in synchronization and `Object`'s wait/notification mechanism. Java supports locks via the commonly used `Lock`, `Condition`, and `ReadWriteLock` interfaces; and via the `ReentrantLock` and `ReentrantReadWriteLock` classes.

The `java.util.concurrent.atomic` package provides a small toolkit of classes that support lock-free, thread-safe operations on single variables. The classes in this package extend the notion of volatile values, fields, and array elements to those that also provide an atomic conditional update so that external synchronization isn't required. Examples of atomic variable classes include `AtomicBoolean` and `AtomicIntegerArray`.

Java's synchronization mechanism impacts hardware utilization and scalability. To overcome this problem, the various Concurrency Utilities types (including the atomic variable classes) are based on the Compare-and-Swap (CAS) instruction, which offers better performance.

CAS is the generic term for an uninterruptible microprocessor-specific instruction that reads a memory location, compares the read value with an expected value, and stores a new value in the memory location when the read value matches the expected value. Otherwise, nothing is done. Modern microprocessors offer variations of CAS. For example, Intel microprocessors provide the `cmpxchg` family of instructions, whereas older PowerPC microprocessors provide equivalent load-link (such as `lwarx`) and store-conditional (such as `stwcx`) instructions.

This chapter ends our tour of Java's Collections Framework and related Concurrency Utilities. In Chapter 11, we'll explore Java's classic I/O APIs: `File`, `RandomAccessFile`, streams, and writers/readers.



# Performing Classic I/O

Applications often input data for processing and output processing results. Data is input from a file or some other source and is output to a file or some other destination. Java supports I/O via the classic I/O APIs located in the `java.io` package and the new I/O APIs located in `java.nio` and related subpackages (and `java.util.regex`). This chapter introduces you to the classic I/O APIs.

**Note** You've already experienced classic I/O in the context of Chapter 1's Standard I/O coverage.

## Working with the File API

Applications often interact with a *filesystem*, which is usually expressed as a hierarchy of files and directories starting from a *root directory*.

Android and other platforms on which a virtual machine runs typically support at least one filesystem. For example, a Unix/Linux (and Linux-based Android) platform combines all *mounted* (attached and prepared) disks into one virtual filesystem. In contrast, Windows associates a separate filesystem with each active disk drive.

Java offers access to the underlying platform's available filesystem(s) via its concrete `java.io.File` class. `File` declares the `File[] listRoots()` class method to return the root directories (roots) of available filesystems as an array of `File` objects.

**Note** The set of available filesystem roots is affected by platform-level operations, such as inserting or ejecting removable media, and disconnecting or unmounting physical or virtual disk drives.

Listing 11-1 presents a `DumpRoots` application that uses `listRoots()` to obtain an array of available filesystem roots and then outputs the array's contents.

*Listing 11-1. Dumping Available Filesystem Roots to Standard Output*

```
import java.io.File;

public class DumpRoots
{
    public static void main(String[] args)
    {
        File[] roots = File.listRoots();
        for (File root: roots)
            System.out.println(root);
    }
}
```

When I run this application on my Windows 7 platform, I receive the following output, which reveals four available roots:

```
C:\
D:\
E:\
F:\
```

If I happened to run `DumpRoots` on a Unix or Linux platform, I would receive one line of output that consists of the virtual filesystem root (`/`).

## Constructing File Instances

Apart from using `listRoots()`, you can obtain a `File` instance by calling a `File` constructor such as `File(String pathname)`, which creates a `File` instance that stores the pathname string. The following assignment statements demonstrate this constructor:

```
File file1 = new File("/x/y");
File file2 = new File("C:\\temp\\x.dat");
```

The first statement assumes a Unix/Linux platform, starts the pathname with root directory symbol `/`, and continues with directory name `x`, separator character `/`, and file or directory name `y`. (It also works on Windows, which assumes this path begins at the root directory on the current drive.)

**Note** A *path* is a hierarchy of directories that must be traversed to locate a file or a directory. A *pathname* is a string representation of a path; a platform-dependent *separator character* (such as the Windows backslash [`\`] character) appears between consecutive names.

The second statement assumes a Windows platform, starts the pathname with drive specifier `C:`, and continues with root directory symbol `\`, directory name `temp`, separator character `\`, and filename `x.dat` (although `x.dat` might refer to a directory). (I could also use forward slashes on Windows.)

**Caution** Always double backslash characters that appear in a string literal, especially when specifying a pathname; otherwise, you run the risk of bugs or compiler error messages. For example, I doubled the backslash characters in the second statement to denote a backslash and not a tab (`\t`) and to avoid a compiler error message (`\x` is illegal).

Each statement's pathname is an *absolute pathname*, which is a pathname that starts with the root directory symbol; no other information is required to locate the file/directory that it denotes. In contrast, a *relative pathname* doesn't start with the root directory symbol; it's interpreted via information taken from some other pathname.

**Note** The `java.io` package's classes default to resolving relative pathnames against the current user (also known as working) directory, which is identified by system property `user.dir` and which is typically the directory in which the virtual machine was launched. (Chapter 7 showed you how to read system properties via `java.lang.System`'s `getProperty()` method.)

File instances contain abstract representations of file and directory pathnames (these files or directories may or may not exist in their filesystems) by storing *abstract pathnames*, which offer platform-independent views of hierarchical pathnames. In contrast, user interfaces and operating systems use platform-dependent *pathname strings* to name files and directories.

An abstract pathname consists of an optional platform-dependent prefix string, such as a disk drive specifier—which is `/` for the Unix/Linux root directory or `\\` for a Windows Universal Naming Convention (UNC) pathname—and a sequence of zero or more string names. The first name in an abstract pathname may be a directory name or, in the case of Windows UNC pathnames, a hostname. Each subsequent name denotes a directory; the last name may denote a directory or a file. The *empty abstract pathname* has no prefix and an empty name sequence.

The conversion of a pathname string to or from an abstract pathname is inherently platform dependent. When a pathname string is converted into an abstract pathname, the names within this string may be separated by the default name-separator character or by any other name-separator character that is supported by the underlying platform. When an abstract pathname is converted into a pathname string, each name is separated from the next by a single copy of the default name-separator character.

**Note** The *default name-separator character* is defined by the system property `file.separator` and is made available in `File`'s public static `separator` and `separatorChar` fields; the first field stores the character in a `java.lang.String` instance and the second field stores it as a `char` value.

`File` offers additional constructors for instantiating this class. For example, the following constructors merge parent and child pathnames into combined pathnames that are stored in `File` objects:

- `File(String parent, String child)` creates a new `File` instance from a parent pathname string and a child pathname string.
- `File(File parent, String child)` creates a new `File` instance from a parent pathname `File` instance and a child pathname string.

Each constructor's parent parameter is passed a *parent pathname*, a string that consists of all pathname components except for the last name, which is specified by child. The following statement demonstrates this concept via `File(String, String)`:

```
File file3 = new File("prj/books/", "ljfad3");
```

The constructor merges parent pathname `prj/books/` with child pathname `ljfad3` into pathname `prj/books/ljfad3`. (If I had specified `prj/books` as the parent pathname, the constructor would have added the separator character after `books`.)

**Tip** Because `File(String pathname)`, `File(String parent, String child)`, and `File(File parent, String child)` don't detect invalid pathname arguments (apart from throwing `java.lang.NullPointerException` when `pathname` or `child` is null), you must be careful when specifying pathnames. You should strive to only specify pathnames that are valid for all platforms on which the application will run. For example, instead of hard-coding a drive specifier (such as `C:`) in a pathname, use the roots that are returned from `listRoots()`. Even better, keep your pathnames relative to the current user/working directory (returned from the `user.dir` system property).

## Learning About Stored Abstract Pathnames

After obtaining a `File` object, you can interrogate it to learn about its stored abstract pathname by calling the methods that are described in Table 11-1.

**Table 11-1.** File Methods for Learning About a Stored Abstract Pathname

Method	Description
<code>File getAbsolutePath()</code>	Returns the absolute form of this <code>File</code> object's abstract pathname. This method is equivalent to <code>new File(this.getAbsolutePath())</code> .
<code>String getAbsolutePath()</code>	Returns the absolute pathname string of this <code>File</code> object's abstract pathname. When it's already absolute, the pathname string is returned as if by calling <code>getPath()</code> . When it's the empty abstract pathname, the pathname string of the current user directory (identified via <code>user.dir</code> ) is returned. Otherwise, the abstract pathname is resolved in a platform-dependent manner. On Unix/Linux platforms, a relative pathname is made absolute by resolving it against the current user directory. On Windows platforms, the pathname is made absolute by resolving it against the current directory of the drive named by the pathname, or the current user directory when there is no drive.
<code>File getCanonicalFile()</code>	Returns the <i>canonical</i> (simplest possible, absolute, and unique) form of this <code>File</code> object's abstract pathname. This method throws <code>java.io.IOException</code> when an I/O error occurs (creating the canonical pathname may require filesystem queries); it equates to <code>new File(this.getCanonicalPath())</code> .

(continued)

**Table 11-1.** (continued)

Method	Description
String getCanonicalPath()	Returns the canonical pathname string of this File object's abstract pathname. This method first converts this pathname to absolute form when necessary, as if by invoking getAbsolutePath(), and then maps it to its unique form in a platform-dependent way. Doing so typically involves removing redundant names such as . and .. from the pathname, resolving symbolic links (on Unix/Linux platforms), and converting drive letters to a standard case (on Windows platforms). This method throws IOException when an I/O error occurs (creating the canonical pathname may require filesystem queries).
String getName()	Returns the filename or directory name denoted by this File object's abstract pathname. This name is the last in a pathname's name sequence. The empty string is returned when the pathname's name sequence is empty.
String getParent()	Returns the parent pathname string of this File object's pathname, or returns null when this pathname doesn't name a parent directory.
File getParentFile()	Returns a File object storing this File object's abstract pathname's parent abstract pathname; returns null when the parent pathname isn't a directory.
String getPath()	Converts this File object's abstract pathname into a pathname string where the names in the sequence are separated by the character stored in File's separator field. Returns the resulting pathname string.
boolean isAbsolute()	Returns true when this File object's abstract pathname is absolute; otherwise, returns false when it's relative. The definition of absolute pathname is system dependent. On Unix/Linux platforms, a pathname is absolute when its prefix is /. On Windows platforms, a pathname is absolute when its prefix is a drive specifier followed by \ or when its prefix is \\.
String toString()	A synonym for getPath().

Table 11-1 refers to IOException, which is the common exception superclass for those exception classes that describe various kinds of I/O errors such as java.io.FileNotFoundException.

Listing 11-2 instantiates File with its pathname command-line argument and calls some of the File methods described in Table 11-1 to learn about this pathname.

**Listing 11-2. Obtaining Abstract Pathname Information**

```
import java.io.File;
import java.io.IOException;

public class PathnameInfo
{
    public static void main(final String[] args) throws IOException
    {
        if (args.length != 1)
        {
            System.err.println("usage: java PathnameInfo pathname");
        }
    }
}
```

```

        return;
    }
    File file = new File(args[0]);
    System.out.println("Absolute path = " + file.getAbsolutePath());
    System.out.println("Canonical path = " + file.getCanonicalPath());
    System.out.println("Name = " + file.getName());
    System.out.println("Parent = " + file.getParent());
    System.out.println("Path = " + file.getPath());
    System.out.println("Is absolute = " + file.isAbsolute());
}
}

```

For example, when I specify `java PathnameInfo .` (the period represents the current directory on my Windows 7 platform), I observe the following output:

```

Absolute path = C:\prj\dev\ljfad3\ch11\code\PathnameInfo\.
Canonical path = C:\prj\dev\ljfad3\ch11\code\PathnameInfo
Name = .
Parent = null
Path = .
Is absolute = false

```

This output reveals that the canonical pathname doesn't include the period. It also shows that there is no parent pathname and that the pathname is relative.

Continuing, I now specify `java PathnameInfo c:\reports\2013\..\2012\February`. This time, I observe the following output:

```

Absolute path = c:\reports\2013\..\2012\February
Canonical path = C:\reports\2012\February
Name = February
Parent = c:\reports\2013\..\2012
Path = c:\reports\2013\..\2012\February
Is absolute = true

```

This output reveals that the canonical pathname doesn't include 2013. It also shows that the pathname is absolute.

For my final example, suppose I specify `java PathnameInfo ""` to obtain information for the empty pathname. In response, this application generates the following output:

```

Absolute path = C:\prj\dev\ljfad3\ch11\code\PathnameInfo
Canonical path = C:\prj\dev\ljfad3\ch11\code\PathnameInfo
Name =
Parent = null
Path =
Is absolute = false

```

The output reveals that `getName()` and `getPath()` return the empty string ("") because the empty pathname is empty.

## Learning About a Pathname's File or Directory

You can interrogate the filesystem to learn about the file or directory represented by a `File` object's stored pathname by calling the methods that are described in Table 11-2.

**Table 11-2.** *File Methods for Learning About a File or Directory*

Method	Description
<code>boolean exists()</code>	Returns true if and only if the file or directory denoted by this <code>File</code> object's abstract pathname exists.
<code>boolean isDirectory()</code>	Returns true when this <code>File</code> object's abstract pathname refers to an existing directory.
<code>boolean isFile()</code>	Returns true when this <code>File</code> object's abstract pathname refers to an existing normal file. A file is <i>normal</i> when it's not a directory and satisfies other platform-dependent criteria: it's not a symbolic link or a named pipe, for example. Any nondirectory file created by a Java application is guaranteed to be a normal file.
<code>boolean isHidden()</code>	Returns true when the file denoted by this <code>File</code> object's abstract pathname is hidden. The exact definition of <i>hidden</i> is platform dependent. On Unix/Linux platforms, a file is hidden when its name begins with a period character. On Windows platforms, a file is hidden when it has been marked as such in the filesystem.
<code>long lastModified()</code>	Returns the time that the file denoted by this <code>File</code> object's abstract pathname was last modified, or 0 when the file doesn't exist or an I/O error occurred during this method call. The returned value is measured in milliseconds since the <i>Unix epoch</i> (00:00:00 GMT, January 1, 1970).
<code>long length()</code>	Returns the length of the file denoted by this <code>File</code> object's abstract pathname. The return value is unspecified when the pathname denotes a directory and will be 0 when the file doesn't exist.

Listing 11-3 instantiates `File` with its pathname command-line argument, and calls all of the `File` methods described in Table 11-2 to learn about the pathname's file/directory.

**Listing 11-3.** *Obtaining File/Directory Information*

```
import java.io.File;
import java.io.IOException;

import java.util.Date;

public class FileDirectoryInfo
{
    public static void main(final String[] args) throws IOException
    {
        if (args.length != 1)
        {
            System.err.println("usage: java FileDirectoryInfo pathname");
        }
    }
}
```

```

        return;
    }
    File file = new File(args[0]);
    System.out.println("About " + file + ":");
    System.out.println("Exists = " + file.exists());
    System.out.println("Is directory = " + file.isDirectory());
    System.out.println("Is file = " + file.isFile());
    System.out.println("Is hidden = " + file.isHidden());
    System.out.println("Last modified = " + new Date(file.lastModified()));
    System.out.println("Length = " + file.length());
}
}

```

For example, suppose I have a three-byte file named `x.dat`. When I specify `java FileDirectoryInfo x.dat`, I observe the following output:

```

About x.dat:
Exists = true
Is directory = false
Is file = true
Is hidden = false
Last modified = Mon Oct 14 15:31:04 CDT 2013
Length = 3

```

## Obtaining Disk Space Information

A *partition* is a platform-specific portion of storage for a filesystem, for example, `C:\`. Obtaining the amount of partition free space is important to installers and other applications. Until Java 6 arrived, the only portable way to accomplish this task was to guess by creating files of different sizes.

Java 6 added to the `File` class `long getFreeSpace()`, `long getTotalSpace()`, and `long getUsableSpace()` methods that return space information about the partition described by the `File` instance's abstract pathname. Android also supports these methods:

- `long getFreeSpace()` returns the number of unallocated bytes in the partition identified by this `File` object's abstract pathname; it returns zero when the abstract pathname doesn't name a partition.
- `long getTotalSpace()` returns the size (in bytes) of the partition identified by this `File` object's abstract pathname; it returns zero when the abstract pathname doesn't name a partition.
- `long getUsableSpace()` returns the number of bytes available to the current virtual machine on the partition identified by this `File` object's abstract pathname; it returns zero when the abstract pathname doesn't name a partition.

Although `getFreeSpace()` and `getUsableSpace()` appear to be equivalent, they differ in the following respect: unlike `getFreeSpace()`, `getUsableSpace()` checks for write permissions and other platform restrictions, resulting in a more accurate estimate.



**Note** The `getFreeSpace()` and `getUsableSpace()` methods return a hint (not a guarantee) that a Java application can use all (or most) of the unallocated or available bytes. These values are a hint because a program running outside the virtual machine can allocate partition space, resulting in actual unallocated and available values being lower than the values returned by these methods.

Listing 11-4 presents an application that demonstrates these methods. After obtaining an array of all available filesystem roots, this application obtains and outputs the free, total, and usable space for each partition identified by the array.

*Listing 11-4. Outputting the Free, Usable, and Total Space on All Partitions*

```
import java.io.File;

public class PartitionSpace
{
    public static void main(String[] args)
    {
        File[] roots = File.listRoots();
        for (File root: roots)
        {
            System.out.println("Partition: " + root);
            System.out.println("Free space on this partition = " +
                root.getFreeSpace());
            System.out.println("Usable space on this partition = " +
                root.getUsableSpace());
            System.out.println("Total space on this partition = " +
                root.getTotalSpace());
            System.out.println("***");
        }
    }
}
```

Compile Listing 11-4 (`javac PartitionSpace.java`) and run the application (`java PartitionSpace`). When run on my Windows 7 machine with a hard drive designated as C:, a DVD drive designated as D:, a USB drive designated as E:, and an extra drive designated as F:, I observe the following output (usually with different free/usable space amounts on C: and E:):

```
Partition: C:\
Free space on this partition = 374407311360
Usable space on this partition = 374407311360
Total space on this partition = 499808989184
***
Partition: D:\
Free space on this partition = 0
Usable space on this partition = 0
Total space on this partition = 0
***
```

```

Partition: E:\
Free space on this partition = 2856464384
Usable space on this partition = 2856464384
Total space on this partition = 8106606592
***
Partition: F:\
Free space on this partition = 0
Usable space on this partition = 0
Total space on this partition = 0
***

```

## Listing Directories

File declares five methods that return the names of files and directories located in the directory identified by a File object's abstract pathname. Table 11-3 describes these methods.

**Table 11-3.** File Methods for Obtaining Directory Content

Method	Description
String[] list()	Returns a potentially empty array of strings naming the files and directories in the directory denoted by this File object's abstract pathname. If the pathname doesn't denote a directory, or if an I/O error occurs, this method returns null. Otherwise, it returns an array of strings, one string for each file or directory in the directory.  Names denoting the directory itself and the directory's parent directory are not included in the result. Each string is a filename rather than a complete path. Also, there is no guarantee that the name strings in the resulting array will appear in alphabetical or any other order.
String[] list(FileNameFilter filter)	A convenience method for calling list() and returning only those Strings that satisfy filter.
File[] listFiles()	A convenience method for calling list(), converting its array of Strings to an array of Files, and returning the Files array.
File[] listFiles(FileFilter filter)	A convenience method for calling list(), converting its array of Strings to an array of Files, but only for those Strings that satisfy filter, and returning the Files array.
File[] listFiles(FileNameFilter filter)	A convenience method for calling list(), converting its array of Strings to an array of Files, but only for those Strings that satisfy filter, and returning the Files array.

The overloaded list() methods return arrays of Strings denoting file and directory names. The second method lets you return only those names of interest (such as only those names that end with extension .txt) via a java.io.FileNameFilter-based filter object.

The `FilenameFilter` interface declares a single `boolean accept(File dir, String name)` method that is called for each file/directory located in the directory identified by the `File` object's pathname:

- `dir` identifies the parent portion of the pathname (the directory path).
- `name` identifies the final directory name or the filename portion of the pathname.

The `accept()` method uses the arguments passed to these parameters to determine whether or not the file or directory satisfies its criteria for what is acceptable. It returns `true` when the file/directory name should be included in the returned array; otherwise, this method returns `false`.

Listing 11-5 presents a `Dir(ectory)` application that uses `list(FilenameFilter)` to obtain only those names that end with a specific extension.

*Listing 11-5. Listing Specific Names*

```
import java.io.File;
import java.io.FilenameFilter;

public class Dir
{
    public static void main(final String[] args)
    {
        if (args.length != 2)
        {
            System.err.println("usage: java Dir dirpath ext");
            return;
        }
        File file = new File(args[0]);
        FilenameFilter fnf = new FilenameFilter()
        {
            @Override
            public boolean accept(File dir, String name)
            {
                return name.endsWith(args[1]);
            }
        };
        String[] names = file.list(fnf);
        for (String name: names)
            System.out.println(name);
    }
}
```

When I, for example, specify `java Dir c:\windows exe` on my Windows 7 platform, `Dir` outputs only those `\windows` directory filenames that have the `.exe` extension:

```
bfsvc.exe
explorer.exe
fveupdate.exe
HelpPane.exe
hh.exe
notepad.exe
```

```
regedit.exe
splwow64.exe
twunk_16.exe
twunk_32.exe
winhlp32.exe
write.exe
```

The overloaded `listFiles()` methods return arrays of `Files`. For the most part, they're symmetrical with their `list()` counterparts. However, `listFiles(FileFilter)` introduces an asymmetry.

The `java.io.FileFilter` interface declares a single `boolean accept(String pathname)` method that is called for each file/directory located in the directory identified by the `File` object's pathname; the argument passed to `pathname` identifies the complete path of the file or directory.

The `accept()` method uses this argument to determine whether or not the file or directory satisfies its criteria for what is acceptable. It returns `true` when the file/directory name should be included in the returned array; otherwise, this method returns `false`.

**Note** Because each interface's `accept()` method accomplishes the same task, you might be wondering which interface to use. If you prefer a path broken into its directory and name components, use `FilenameFilter`. However, if you prefer a complete pathname, use `FileFilter`; you can always call `getParent()` and `getName()` to get these components.

## Creating and Manipulating Files and Directories

`File` also declares several methods for creating new files and directories and manipulating existing files and directories. Table 11-4 describes these methods.

**Table 11-4.** *File Methods for Creating New and Manipulating Existing Files and Directories*

Method	Description
<code>boolean createNewFile()</code>	Atomically creates a new, empty file named by this <code>File</code> object's abstract pathname if and only if a file with this name doesn't yet exist. The check for file existence (and the creation of the file when it doesn't exist) is a single operation that's atomic with respect to all other filesystem activities that might affect the file. This method returns <code>true</code> when the named file doesn't exist and was successfully created, and returns <code>false</code> when the named file already exists. It throws <code>IOException</code> when an I/O error occurs.
<code>static File createTempFile(String prefix, String suffix)</code>	Creates an empty file in the default temporary file directory using the given prefix and suffix to generate its name. This overloaded class method calls its three-parameter variant, passing <code>prefix</code> , <code>suffix</code> , and <code>null</code> to this other method, and returning the other method's return value.

*(continued)*

Table 11-4. (continued)

Method	Description
static File createTempFile(String prefix, String suffix, File directory)	Creates an empty file in the specified directory using the given prefix and suffix to generate its name. The name begins with the character sequence specified by prefix and ends with the character sequence specified by suffix; .tmp is used as the suffix when suffix is null. This method returns the created file's pathname when successful. It throws <code>java.lang.IllegalArgumentException</code> when prefix contains fewer than three characters and <code>IOException</code> when the file couldn't be created.
boolean delete()	Deletes the file or directory denoted by this File object's pathname. Returns true when successful; otherwise, returns false. If the pathname denotes a directory, the directory must be empty in order to be deleted.
void deleteOnExit()	Requests that the file or directory denoted by this File object's abstract pathname be deleted when the virtual machine terminates. Reinvoking this method on the same File object has no effect. Once deletion has been requested, it's not possible to cancel the request. Therefore, this method should be used with care.
boolean mkdir()	Creates the directory named by this File object's abstract pathname. Returns true when successful; otherwise, returns false.
boolean mkdirs()	Creates the directory and any necessary intermediate directories named by this File object's abstract pathname. Returns true when successful; otherwise, returns false.
boolean renameTo(File dest)	<p>Renames the file denoted by this File object's abstract pathname to dest. Returns true when successful; otherwise, returns false. This method throws <code>NullPointerException</code> when dest is null.</p> <p>Many aspects of this method's behavior are platform dependent. For example, the rename operation might not be able to move a file from one filesystem to another, the operation might not be atomic, or it might not succeed when a file with the destination pathname already exists. The return value should always be checked to make sure that the rename operation was successful.</p>
boolean setLastModified(long time)	<p>Sets the last-modified time of the file or directory named by this File object's abstract pathname. Returns true when successful; otherwise, returns false. This method throws <code>IllegalArgumentException</code> when time is negative.</p> <p>All platforms support file-modification times to the nearest second, but some provide more precision. The time value will be truncated to fit the supported precision. If the operation succeeds and no intervening operations on the file take place, the next call to <code>lastModified()</code> will return the (possibly truncated) time value passed to this method.</p>

Suppose you're designing a text-editor application that a user will use to open a text file and make changes to its content. Until the user explicitly saves these changes to the file, you want the text file to remain unchanged.

Because the user doesn't want to lose these changes when the application crashes or the computer loses power, you design the application to save these changes to a temporary file every few minutes. This way, the user has a backup of the changes.

You can use the overloaded `createTempFile()` methods to create the temporary file. If you don't specify a directory in which to store this file, it's created in the directory identified by the `java.io.tmpdir` system property.

You probably want to remove the temporary file after the user tells the application to save or discard the changes. The `deleteOnExit()` method lets you register a temporary file for deletion; it's deleted when the virtual machine ends without a crash/power loss.

Listing 11-6 presents a `TempFileDemo` application for experimenting with the `createTempFile()` and `deleteOnExit()` methods.

*Listing 11-6. Experimenting with Temporary Files*

```
import java.io.File;
import java.io.IOException;

public class TempFileDemo
{
    public static void main(String[] args) throws IOException
    {
        System.out.println(System.getProperty("java.io.tmpdir"));
        File temp = File.createTempFile("text", ".txt");
        System.out.println(temp);
        temp.deleteOnExit();
    }
}
```

After outputting the location where temporary files are stored, `TempFileDemo` creates a temporary file whose name begins with `text` and ends with the `.txt` extension. `TempFileDemo` next outputs the temporary file's name and registers the temporary file for deletion upon the successful termination of the application.

I observed the following output during one run of `TempFileDemo` (and the file disappeared on exit):

```
C:\Users\Owner\AppData\Local\Temp\
C:\Users\Owner\AppData\Local\Temp\text3173127870811188221.txt
```

## Setting and Getting Permissions

Java 1.2 added a boolean `setReadOnly()` method to the `File` class to mark a file or directory as read-only. However, a method to revert the file or directory to the writable state wasn't added. More importantly, until Java 6's arrival, `File` offered no way to manage an abstract pathname's read, write, and execute permissions.

Java 6 added to `File` `boolean setExecutable(boolean executable)`, `boolean setExecutable(boolean executable, boolean ownerOnly)`, `boolean setReadable(boolean readable)`, `boolean setReadable(boolean readable, boolean ownerOnly)`, `boolean setWritable(boolean writable)`, and `boolean setWritable(boolean writable, boolean ownerOnly)` methods that let you set the owner's or everybody's execute, read, and write permissions for the file identified by the `File` object's abstract pathname. Android also supports these methods:

- `boolean setExecutable(boolean executable, boolean ownerOnly)` enables (pass true to `executable`) or disables (pass false to `executable`) this abstract pathname's execute permission for its owner (pass true to `ownerOnly`) or everyone (pass false to `ownerOnly`). When the filesystem doesn't differentiate between the owner and everyone, this permission always applies to everyone. It returns true when the operation succeeds. It returns false when the user doesn't have permission to change this abstract pathname's access permissions or when `executable` is false and the filesystem doesn't implement an execute permission.
- `boolean setExecutable(boolean executable)` is a convenience method that invokes the previous method to set the execute permission for the owner.
- `boolean setReadable(boolean readable, boolean ownerOnly)` enables (pass true to `readable`) or disables (pass false to `readable`) this abstract pathname's read permission for its owner (pass true to `ownerOnly`) or everyone (pass false to `ownerOnly`). When the filesystem doesn't differentiate between the owner and everyone, this permission always applies to everyone. It returns true when the operation succeeds. It returns false when the user doesn't have permission to change this abstract pathname's access permissions or when `readable` is false and the filesystem doesn't implement a read permission.
- `boolean setReadable(boolean readable)` is a convenience method that invokes the previous method to set the read permission for the owner.
- `boolean setWritable(boolean writable, boolean ownerOnly)` enables (pass true to `writable`) or disables (pass false to `writable`) this abstract pathname's write permission for its owner (pass true to `ownerOnly`) or everyone (pass false to `ownerOnly`). When the filesystem doesn't differentiate between the owner and everyone, this permission always applies to everyone. It returns true when the operation succeeds. It returns false when the user doesn't have permission to change this abstract pathname's access permissions.
- `boolean setWritable(boolean writable)` is a convenience method that invokes the previous method to set the write permission for the owner.

Along with these methods, Java 6 retrofitted `File`'s `boolean canRead()` and `boolean canWrite()` methods, and introduced a `boolean canExecute()` method to return an abstract pathname's access permissions. These methods return true when the file or directory object identified by the abstract pathname exists and when the appropriate permission is in effect. For example, `canWrite()` returns true when the abstract pathname exists and when the application has permission to write to the file.

The `canRead()`, `canWrite()`, and `canExecute()` methods can be used to implement a simple utility that identifies which permissions have been assigned to an arbitrary file or directory. This utility's source code is presented in Listing 11-7.

*Listing 11-7. Checking a File's or Directory's Permissions*

```
import java.io.File;

public class Permissions
{
    public static void main(String[] args)
    {
        if (args.length != 1)
        {
            System.err.println("usage: java Permissions filespec");
            return;
        }
        File file = new File(args[0]);
        System.out.println("Checking permissions for " + args[0]);
        System.out.println("  Execute = " + file.canExecute());
        System.out.println("  Read = " + file.canRead());
        System.out.println("  Write = " + file.canWrite());
    }
}
```

Compile Listing 11-7 (`javac Permissions.java`). Assuming a readable and executable (only) file named `x` in the current directory, `java Permissions x` generates the following output:

```
Checking permissions for x
Execute = true
Read = true
Write = false
```

## Exploring Miscellaneous Capabilities

Finally, `File` implements the `java.lang.Comparable` interface's `compareTo()` method and overrides `equals()` and `hashCode()`. Table 11-5 describes these miscellaneous methods.

**Table 11-5.** *File's Miscellaneous Methods*

Method	Description
<code>int compareTo(File pathname)</code>	Compares two pathnames lexicographically. The ordering defined by this method depends upon the underlying platform. On Unix/Linux platforms, alphabetic case is significant when comparing pathnames; on Windows platforms, alphabetic case is insignificant. Returns zero when <code>pathname</code> 's abstract pathname equals this <code>File</code> object's abstract pathname, a negative value when this <code>File</code> object's abstract pathname is less than <code>pathname</code> , and a positive value otherwise. To accurately compare two <code>File</code> objects, call <code>getCanonicalFile()</code> on each <code>File</code> object and then compare the returned <code>File</code> objects.

*(continued)*



Table 11-5. (continued)

Method	Description
<code>boolean equals(Object obj)</code>	Compares this File object with <code>obj</code> for equality. Abstract pathname equality depends upon the underlying platform. On Unix/Linux platforms, alphabetic case is significant when comparing pathnames; on Windows platforms, alphabetic case is insignificant. Returns true if and only if <code>obj</code> is not null and is a File object whose abstract pathname denotes the same file/directory as this File object's abstract pathname.
<code>int hashCode()</code>	Calculates and returns a hash code for this pathname. This calculation depends upon the underlying platform. On Unix/Linux platforms, a pathname's hash code equals the exclusive OR of its pathname string's hash code and decimal value 1234321. On Windows platforms, the hash code is the exclusive OR of the lowercased pathname string's hash code and decimal value 1234321. The current <i>locale</i> (geographical, political, or cultural region) is not taken into account when lowercasing the pathname string.

Listing 11-8 presents an application that demonstrates `compareTo()` along with `getCanonicalFile()`.

*Listing 11-8. Comparing Files*

```
import java.io.File;
import java.io.IOException;

public class Compare
{
    public static void main(String[] args) throws IOException
    {
        if (args.length != 2)
        {
            System.err.println("usage: java Compare filespec1 filespec2");
            return;
        }

        File file1 = new File(args[0]);
        File file2 = new File(args[1]);
        System.out.println(file1.compareTo(file2));
        System.out.println(file1.getCanonicalFile()
            .compareTo(file2.getCanonicalFile()));
    }
}
```

Compile Listing 11-8 (`javac Compare.java`). Assuming successful compilation and a Windows platform, execute the following command line:

```
java Compare Compare.class .\Compare.class
```

You should observe the following output:

```
53  
0
```

The 53 indicates that `file1`'s abstract pathname is lexicographically greater than `file2`'s abstract pathname. However, when comparing their canonical representations, these abstract pathnames are considered to be identical (as indicated by the 0).

## Working with the `RandomAccessFile` API

Files can be created and/or opened for *random access* in which a mixture of write and read operations can occur until the file is closed. Java supports this random access via its concrete `java.io.RandomAccessFile` class.

**Note** `RandomAccessFile` has its place in Android app development. For example, you can use this class to read an app's raw resource file. To learn how, check out "RandomAccessFile in Android raw resource file" (<http://stackoverflow.com/questions/9335379/randomaccessfile-in-android-raw-resource-file>).

`RandomAccessFile` declares the following constructors:

- `RandomAccessFile(File file, String mode)` creates and opens a new file if it doesn't exist or opens an existing file. The file is identified by `file`'s abstract pathname and is created and/or opened according to `mode`.
- `RandomAccessFile(String pathname, String mode)` creates and opens a new file if it doesn't exist or opens an existing file. The file is identified by `pathname` and is created and/or opened according to `mode`.

Either constructor's `mode` argument must be one of "r", "rw", "rws", or "rwd"; otherwise, the constructor throws `IllegalArgumentException`. These string literals have the following meanings:

- "r" informs the constructor to open an existing file for reading only. Any attempt to write to the file results in a thrown instance of the `IOException` class.
- "rw" informs the constructor to create and open a new file when it doesn't exist for reading and writing or open an existing file for reading and writing.

- "rwd" informs the constructor to create and open a new file when it doesn't exist for reading and writing or open an existing file for reading and writing. Furthermore, each update to the file's content must be written synchronously to the underlying storage device.
- "rws" informs the constructor to create and open a new file when it doesn't exist for reading and writing or open an existing file for reading and writing. Furthermore, each update to the file's content or metadata must be written synchronously to the underlying storage device.

**Note** A file's *metadata* is data about the file and not actual file contents. Examples of metadata include the file's length and the time the file was last modified.

The "rwd" and "rws" modes ensure that any writes to a file located on a local storage device are written to the device, which guarantees that critical data isn't lost when the operating system crashes. No guarantee is made when the file doesn't reside on a local device.

**Note** Operations on a random access file opened in "rwd" or "rws" mode are slower than these same operations on a random access file opened in "rw" mode.

These constructors throw `FileNotFoundException` when mode is "r" and the file identified by `pathname` cannot be opened (it might not exist or it might be a directory) or when mode is "rw" and `pathname` is read-only or a directory.

The following example demonstrates the second constructor by attempting to open an existing file for read access via the "r" mode string:

```
RandomAccessFile raf = new RandomAccessFile("employee.dat", "r");
```

A random access file is associated with a *file pointer*, a cursor that identifies the location of the next byte to write or read. When an existing file is opened, the file pointer is set to its first byte at offset 0. The file pointer is also set to 0 when the file is created.

Write or read operations start at the file pointer and advance it past the number of bytes written or read. Operations that write past the current end of the file cause the file to be extended. These operations continue until the file is closed.

`RandomAccessFile` declares a wide variety of methods. I present a representative sample of these methods in Table 11-6.

**Table 11-6. RandomAccessFile Methods**

Method	Description
<code>void close()</code>	Closes the file and releases any associated platform resources. Subsequent writes or reads result in <code>IOException</code> . Also, the file cannot be reopened with this <code>RandomAccessFile</code> object. This method throws <code>IOException</code> when an I/O error occurs.
<code>FileDescriptor getFD()</code>	Returns the file's associated file descriptor object. This method throws <code>IOException</code> when an I/O error occurs.
<code>long getFilePointer()</code>	Returns the file pointer's current zero-based byte offset into the file. This method throws <code>IOException</code> when an I/O error occurs.
<code>long length()</code>	Returns the length (measured in bytes) of the file. This method throws <code>IOException</code> when an I/O error occurs.
<code>int read()</code>	Reads and returns (as an <code>int</code> in the range 0 to 255) the next byte from the file or returns -1 when the end of the file is reached. This method blocks when no input is available and throws <code>IOException</code> when an I/O error occurs.
<code>int read(byte[] b)</code>	Reads up to <code>b.length</code> bytes of data from the file into byte array <code>b</code> . This method blocks until at least 1 byte of input is available. It returns the number of bytes read into the array, or returns -1 when the end of the file is reached. It throws <code>NullPointerException</code> when <code>b</code> is <code>null</code> and <code>IOException</code> when an I/O error occurs.
<code>char readChar()</code>	Reads and returns a character from the file. This method reads 2 bytes from the file starting at the current file pointer. If the bytes read, in order, are <code>b1</code> and <code>b2</code> , where $0 \leq b1, b2 \leq 255$ , the result is equal to <code>(char) ((b1 &lt;&lt; 8)   b2)</code> . This method blocks until the 2 bytes are read, the end of the file is detected, or an exception is thrown. It throws <code>java.io.EOFException</code> (a subclass of <code>IOException</code> ) when the end of the file is reached before reading both bytes, and <code>IOException</code> when an I/O error occurs.
<code>int readInt()</code>	Reads and returns a 32-bit integer from the file. This method reads 4 bytes from the file starting at the current file pointer. If the bytes read, in order, are <code>b1</code> , <code>b2</code> , <code>b3</code> , and <code>b4</code> , where $0 \leq b1, b2, b3, b4 \leq 255$ , the result is equal to <code>(b1 &lt;&lt; 24)   (b2 &lt;&lt; 16)   (b3 &lt;&lt; 8)   b4</code> . This method blocks until the 4 bytes are read, the end of the file is detected, or an exception is thrown. It throws <code>EOFException</code> when the end of the file is reached before reading the 4 bytes and <code>IOException</code> when an I/O error occurs.
<code>void seek(long pos)</code>	Sets the file pointer's current offset to <code>pos</code> (which is measured in bytes from the beginning of the file). If the offset is set beyond the end of the file, the file's length doesn't change. The file length will only change by writing after the offset has been set beyond the end of the file. This method throws <code>IOException</code> when the value in <code>pos</code> is negative or when an I/O error occurs.

*(continued)*

Table 11-6. (continued)

Method	Description
<code>void setLength(long newLength)</code>	Sets the file's length. If the present length as returned by <code>length()</code> is greater than <code>newLength</code> , the file is truncated. In this case, if the file offset as returned by <code>getFilePointer()</code> is greater than <code>newLength</code> , the offset will be equal to <code>newLength</code> after <code>setLength()</code> returns. If the present length is smaller than <code>newLength</code> , the file is extended. In this case, the contents of the extended portion of the file are not defined. This method throws <code>IOException</code> when an I/O error occurs.
<code>int skipBytes(int n)</code>	Attempts to skip over <code>n</code> bytes. This method skips over a smaller number of bytes (possibly zero) when the end of file is reached before <code>n</code> bytes have been skipped. It doesn't throw <code>EOFException</code> in this situation. If <code>n</code> is negative, no bytes are skipped. The actual number of bytes skipped is returned. This method throws <code>IOException</code> when an I/O error occurs.
<code>void write(byte[] b)</code>	Writes <code>b.length</code> bytes from byte array <code>b</code> to the file starting at the current file pointer position. This method throws <code>IOException</code> when an I/O error occurs.
<code>void write(int b)</code>	Writes the lower 8 bits of <code>b</code> to the file at the current file pointer position. This method throws <code>IOException</code> when an I/O error occurs.
<code>void writeChars(String s)</code>	Writes string <code>s</code> to the file as a sequence of characters starting at the current file pointer position. This method throws <code>IOException</code> when an I/O error occurs.
<code>void writeInt(int i)</code>	Writes 32-bit integer <code>i</code> to the file starting at the current file pointer position. The 4 bytes are written with the high byte first. This method throws <code>IOException</code> when an I/O error occurs.

Most of Table 11-6's methods are fairly self-explanatory. However, the `getFD()` method requires further enlightenment.

**Note** `RandomAccessFile`'s read-prefixed methods and `skipBytes()` originate in the `java.io.DataInput` interface, which this class implements. Furthermore, `RandomAccessFile`'s write-prefixed methods originate in the `java.io.DataOutput` interface, which this class also implements.

When a file is opened, the underlying platform creates a platform-dependent structure to represent the file. A handle to this structure is stored in an instance of the `java.io.FileDescriptor` class, which `getFD()` returns.

**Note** A *handle* is an identifier that Java passes to the underlying platform to identify, in this case, a specific open file when it requires that the underlying platform perform a file operation.

`FileDescriptor` is a small class that declares three `FileDescriptor` constants named `in`, `out`, and `err`. These constants let `System.in`, `System.out`, and `System.err` (discussed later in this chapter) provide access to the standard input, standard output, and standard error streams.

`FileDescriptor` also declares the following pair of methods:

- `void sync()` tells the underlying platform to *flush* (empty) the contents of the open file's output buffers to their associated local disk device. `sync()` returns after all modified data and attributes have been written to the relevant device. It throws `java.io.SyncFailedException` when the buffers cannot be flushed or because the platform cannot guarantee that all the buffers have been synchronized with physical media.
- `boolean valid()` determines whether or not this file descriptor object is valid. It returns `true` when the file descriptor object represents an open file or other active I/O connection; otherwise, it returns `false`.

Data that is written to an open file ends up being stored in the underlying platform's output buffers. When the buffers fill to capacity, the platform empties them to the disk. Buffers improve performance because disk access is slow.

However, when you write data to a random access file that's been opened via mode `"rwd"` or `"rws"`, each write operation's data is written straight to the disk. As a result, write operations are slower than when the random access file is opened in `"rw"` mode.

Suppose you have a situation that combines writing data through the output buffers and writing data directly to the disk. The following example addresses this hybrid scenario by opening the file in mode `"rw"` and selectively calling `FileDescriptor`'s `sync()` method.

```
RandomAccessFile raf = new RandomAccessFile("employee.dat", "rw");
FileDescriptor fd = raf.getFD();
// Perform a critical write operation.
raf.write(...);
// Synchronize with underlying disk by flushing platform's output buffers to disk.
fd.sync();
// Perform non-critical write operation where synchronization isn't necessary.
raf.write(...);
// Do other work.
// Close file, emptying output buffers to disk.
raf.close();
```

`RandomAccessFile` is useful for creating a *flat file database*, a single file organized into records and fields. A *record* stores a single entry (such as a part in a parts database) and a *field* stores a single attribute of the entry (such as a part number).

**Note** The term *field* is also used to refer to a variable declared within a class. To avoid confusion with this overloaded terminology, think of a field variable as being analogous to a record's field attribute.

A flat file database typically organizes its content into a sequence of fixed-length records. Each record is further organized into one or more fixed-length fields. Figure 11-1 illustrates this concept in the context of a parts database.

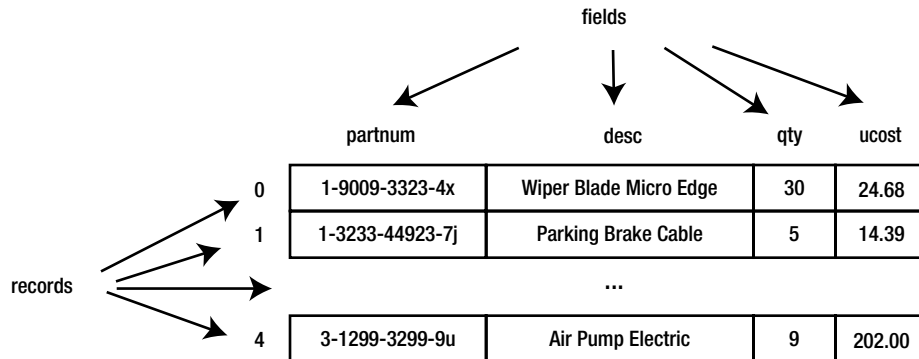

**Figure 11-1.** A flat file database of automotive parts is divided into records and fields

According to Figure 11-1, each field has a name (partnum, desc, qty, and ucost). Also, each record is assigned a number starting at 0. This example consists of five records, of which only three are shown for brevity.

To show you how to implement a flat file database in terms of `RandomAccessFile`, I've created a simple `PartsDB` class to model Figure 11-1. Check out Listing 11-9.

**Listing 11-9.** Implementing the Parts Flat File Database

```
import java.io.IOException;
import java.io.RandomAccessFile;

public class PartsDB
{
    public final static int PNUMLEN = 20;
    public final static int DESCLEN = 30;
    public final static int QUANLEN = 4;
    public final static int COSTLEN = 4;

    private final static int RECLEN = 2 * PNUMLEN + 2 * DESCLEN + QUANLEN + COSTLEN;
    private RandomAccessFile raf;

    public PartsDB(String pathname) throws IOException
    {
        raf = new RandomAccessFile(pathname, "rw");
    }

    public void append(String partnum, String partdesc, int qty, int ucost)
        throws IOException
    {
        raf.seek(raf.length());
        write(partnum, partdesc, qty, ucost);
    }
}
```

```
public void close()
{
    try
    {
        raf.close();
    }
    catch (IOException ioe)
    {
        System.err.println(ioe);
    }
}

public int numRecs() throws IOException
{
    return (int) raf.length() / RECLLEN;
}

public Part select(int recno) throws IOException
{
    if (recno < 0 || recno >= numRecs())
        throw new IllegalArgumentException(recno + " out of range");
    raf.seek(recno * RECLLEN);
    return read();
}

public void update(int recno, String partnum, String partdesc, int qty,
                  int ucost) throws IOException
{
    if (recno < 0 || recno >= numRecs())
        throw new IllegalArgumentException(recno + " out of range");
    raf.seek(recno * RECLLEN);
    write(partnum, partdesc, qty, ucost);
}

private Part read() throws IOException
{
    StringBuffer sb = new StringBuffer();
    for (int i = 0; i < PNUMLEN; i++)
        sb.append(raf.readChar());
    String partnum = sb.toString().trim();
    sb.setLength(0);
    for (int i = 0; i < DESCLEN; i++)
        sb.append(raf.readChar());
    String partdesc = sb.toString().trim();
    int qty = raf.readInt();
    int ucost = raf.readInt();
    return new Part(partnum, partdesc, qty, ucost);
}
```



```

private void write(String partnum, String partdesc, int qty, int ucost)
    throws IOException
{
    StringBuffer sb = new StringBuffer(partnum);
    if (sb.length() > PNUMLEN)
        sb.setLength(PNUMLEN);
    else
        if (sb.length() < PNUMLEN)
        {
            int len = PNUMLEN - sb.length();
            for (int i = 0; i < len; i++)
                sb.append(" ");
        }
    raf.writeChars(sb.toString());
    sb = new StringBuffer(partdesc);
    if (sb.length() > DESCLEN)
        sb.setLength(DESCLEN);
    else
        if (sb.length() < DESCLEN)
        {
            int len = DESCLEN - sb.length();
            for (int i = 0; i < len; i++)
                sb.append(" ");
        }
    raf.writeChars(sb.toString());
    raf.writeInt(qty);
    raf.writeInt(ucost);
}

public static class Part
{
    private String partnum;
    private String desc;
    private int qty;
    private int ucost;

    public Part(String partnum, String desc, int qty, int ucost)
    {
        this.partnum = partnum;
        this.desc = desc;
        this.qty = qty;
        this.ucost = ucost;
    }

    String getDesc()
    {
        return desc;
    }

    String getPartnum()
    {
        return partnum;
    }
}

```

```

    int getQty()
    {
        return qty;
    }

    int getUnitCost()
    {
        return ucost;
    }
}
}

```

PartsDB first declares constants that identify the lengths of the string and 32-bit integer fields. It then declares a constant that calculates the record length in terms of bytes. The calculation takes into account the fact that a character occupies 2 bytes in the file.

These constants are followed by a field named `raf` that is of type `RandomAccessFile`. This field is assigned an instance of the `RandomAccessFile` class in the subsequent constructor, which creates/opens a new file or opens an existing file because of "rw".

PartsDB next declares `append()`, `close()`, `numRecs()`, `select()`, and `update()`. These methods append a record to the file, close the file, return the number of records in the file, select and return a specific record, and update a specific record.

- The `append()` method first calls `length()` and `seek()`. Doing so ensures that the file pointer is positioned to the end of the file before calling the private `write()` method to write a record containing this method's arguments.
- `RandomAccessFile`'s `close()` method can throw `IOException`. Because this is a rare occurrence, I chose to handle this exception in `PartDB`'s `close()` method, which keeps that method's signature simple. However, I print a message when `IOException` occurs.
- The `numRecs()` method returns the number of records in the file. These records are numbered starting with 0 and ending with `numRecs() - 1`. Each of the `select()` and `update()` methods verifies that its `recno` argument lies within this range.
- The `select()` method calls the private `read()` method to return the record identified by `recno` as an instance of the nested `Part` class. `Part`'s constructor initializes a `Part` object to a record's field values, and its getter methods return these values.
- The `update()` method is equally simple. As with `select()`, it first positions the file pointer to the start of the record identified by `recno`. As with `append()`, it calls `write()` to write out its arguments but replaces a record instead of adding one.

Records are written with the private `write()` method. Because fields must have exact sizes, `write()` pads String-based values that are shorter than a field size with spaces on the right and truncates these values to the field size when needed.

Records are read via the private `read()` method. `read()` removes the padding before saving a String-based field value in the `Part` object.

By itself, PartsDB is useless. You need an application that lets you experiment with this class, and Listing 11-10 fulfills this requirement.

*Listing 11-10. Experimenting with the Parts Flat File Database*

```
import java.io.IOException;

public class UsePartsDB
{
    public static void main(String[] args)
    {
        PartsDB pdb = null;
        try
        {
            pdb = new PartsDB("parts.db");
            if (pdb.numRecs() == 0)
            {
                // Populate the database with records.
                pdb.append("1-9009-3323-4x", "Wiper Blade Micro Edge", 30, 2468);
                pdb.append("1-3233-44923-7j", "Parking Brake Cable", 5, 1439);
                pdb.append("2-3399-6693-2m", "Halogen Bulb H4 55/60W", 22, 813);
                pdb.append("2-599-2029-6k", "Turbo Oil Line O-Ring ", 26, 155);
                pdb.append("3-1299-3299-9u", "Air Pump Electric", 9, 20200);
            }
            dumpRecords(pdb);
            pdb.update(1, "1-3233-44923-7j", "Parking Brake Cable", 5, 1995);
            dumpRecords(pdb);
        }
        catch (IOException ioe)
        {
            System.err.println(ioe);
        }
        finally
        {
            if (pdb != null)
                pdb.close();
        }
    }

    static void dumpRecords(PartsDB pdb) throws IOException
    {
        for (int i = 0; i < pdb.numRecs(); i++)
        {
            PartsDB.Part part = pdb.select(i);
            System.out.print(format(part.getPartnum(), PartsDB.PNUMLEN, true));
            System.out.print(" | ");
            System.out.print(format(part.getDesc(), PartsDB.DESCLEN, true));
            System.out.print(" | ");
            System.out.print(format("" + part.getQty(), 10, false));
            System.out.print(" | ");
            String s = part.getUnitCost() / 100 + "." + part.getUnitCost() % 100;
            if (s.charAt(s.length() - 2) == '.') s += "0";
```

```

        System.out.println(format(s, 10, false));
    }
    System.out.println("Number of records = " + pdb.numRecs());
    System.out.println();
}

static String format(String value, int maxWidth, boolean leftAlign)
{
    StringBuffer sb = new StringBuffer();
    int len = value.length();
    if (len > maxWidth)
    {
        len = maxWidth;
        value = value.substring(0, len);
    }
    if (leftAlign)
    {
        sb.append(value);
        for (int i = 0; i < maxWidth-len; i++)
            sb.append(" ");
    }
    else
    {
        for (int i = 0; i < maxWidth-len; i++)
            sb.append(" ");
        sb.append(value);
    }
    return sb.toString();
}
}

```

Listing 11-10's `main()` method begins by instantiating `PartsDB`, with `parts.db` as the name of the database file. When this file has no records, `numRecs()` returns 0 and several records are appended to the file via the `append()` method.

`main()` next dumps the five records stored in `parts.db` to the standard output stream, updates the unit cost in the record whose number is 1, once again dumps these records to the standard output stream to show this change, and closes the database.

**Note** I store unit cost values as integer-based penny amounts. For example, I specify literal 1995 to represent 1995 pennies, or \$19.95. If I were to use `java.math.BigDecimal` objects to store currency values, I would have to refactor `PartsDB` to take advantage of object serialization, and I'm not prepared to do that right now. (I discuss object serialization later in this chapter.)

`main()` relies on a `dumpRecords()` helper method to dump these records, and `dumpRecords()` relies on a `format()` helper method to format field values so that they can be presented in properly aligned columns—I could have used `java.util.Formatter` (see Chapter 13) instead. The following output reveals this alignment:

1-9009-3323-4x	Wiper Blade Micro Edge	30	24.68
1-3233-44923-7j	Parking Brake Cable	5	14.39
2-3399-6693-2m	Halogen Bulb H4 55/60W	22	8.13
2-599-2029-6k	Turbo Oil Line O-Ring	26	1.55
3-1299-3299-9u	Air Pump Electric	9	202.00

Number of records = 5

1-9009-3323-4x	Wiper Blade Micro Edge	30	24.68
1-3233-44923-7j	Parking Brake Cable	5	19.95
2-3399-6693-2m	Halogen Bulb H4 55/60W	22	8.13
2-599-2029-6k	Turbo Oil Line O-Ring	26	1.55
3-1299-3299-9u	Air Pump Electric	9	202.00

Number of records = 5

And there you have it: a simple flat file database. Despite its lack of support for advanced database features such as indexes and transaction management, a flat file database might be all that your Android application requires.

**Note** To learn more about flat file databases, check out Wikipedia’s “Flat file database” entry ([http://en.wikipedia.org/wiki/Flat\\_file\\_database](http://en.wikipedia.org/wiki/Flat_file_database)).

## Working with Streams

Along with `File` and `RandomAccessFile`, Java uses streams to perform I/O operations. A *stream* is an ordered sequence of bytes of arbitrary length. Bytes flow over an *output stream* from an application to a destination and flow over an *input stream* from a source to an application. Figure 11-2 illustrates these flows.

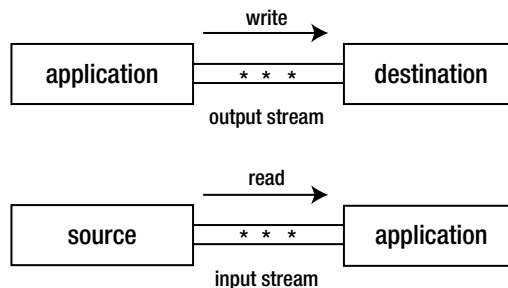

**Figure 11-2.** Conceptualizing output and input streams as flows of bytes

**Note** Java’s use of the word *stream* is analogous to stream of water, stream of electrons, and so on.

Java recognizes various stream destinations, such as byte arrays, files, screens, *sockets* (network endpoints), and thread pipes. Java also recognizes various stream sources. Examples include byte arrays, files, keyboards, sockets, and thread pipes. (I will discuss sockets in Chapter 12.)

## Stream Classes Overview

The `java.io` package provides several output stream and input stream classes that are descendants of the abstract `OutputStream` and `InputStream` classes. Figure 11-3 reveals the hierarchy of output stream classes.

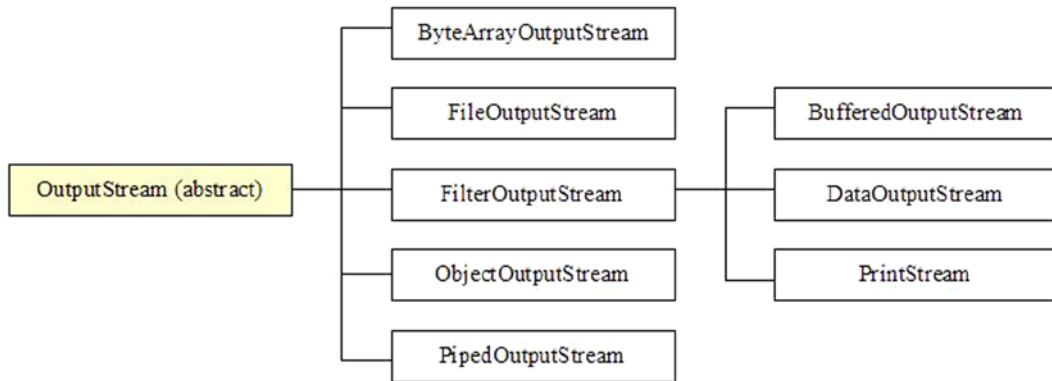

**Figure 11-3.** All output stream classes except for `PrintStream` are denoted by their `OutputStream` suffixes

Figure 11-4 reveals the hierarchy of input stream classes.

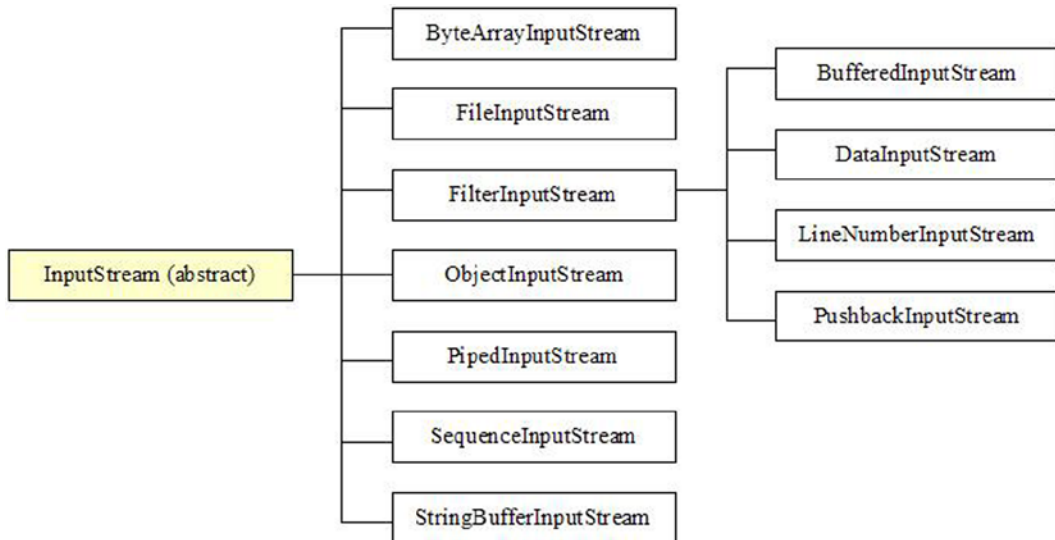

**Figure 11-4.** Note that `LineNumberInputStream` and `StringBufferInputStream` are deprecated

`LineNumberInputStream` and `StringBufferInputStream` have been deprecated because they don't support different character encodings, a topic I discuss later in this chapter. `LineNumberReader` and `StringReader` are their replacements. (I discuss readers later in this chapter.)

**Note** `PrintStream` is another class that should be deprecated because it doesn't support different character encodings; `PrintWriter` is its replacement. However, it's doubtful that Oracle (and Google) will deprecate this class because `PrintStream` is the type of the `System` class's `out` and `err` class fields, and too much legacy code depends upon this fact.

Other Java packages provide additional output stream and input stream classes. For example, `java.util.zip` provides four output stream classes that compress uncompressed data into various formats and four matching input stream classes that uncompress compressed data from the same formats:

- `CheckedOutputStream`
- `CheckedInputStream`
- `DeflaterOutputStream`
- `GZIPOutputStream`
- `GZIPInputStream`
- `InflaterInputStream`
- `ZipOutputStream`
- `ZipInputStream`

Also, the `java.util.jar` package provides a pair of stream classes for writing content to a JAR file and for reading content from a JAR file:

- `JarOutputStream`
- `JarInputStream`

In the next several sections, I take you on a tour of most of `java.io`'s output stream and input stream classes, beginning with `OutputStream` and `InputStream`.

## OutputStream and InputStream

Java provides the `OutputStream` and `InputStream` classes for performing stream I/O. `OutputStream` is the superclass of all output stream subclasses. Table 11-7 describes `OutputStream`'s methods.

**Table 11-7. OutputStream Methods**

Method	Description
<code>void close()</code>	Closes this output stream and releases any platform resources associated with the stream. This method throws <code>IOException</code> when an I/O error occurs.
<code>void flush()</code>	Flushes this output stream by writing any buffered output bytes to the destination. If the intended destination of this output stream is an abstraction provided by the underlying platform (for example, a file), flushing the stream only guarantees that bytes previously written to the stream are passed to the underlying platform for writing; it doesn't guarantee that they're actually written to a physical device such as a disk drive. This method throws <code>IOException</code> when an I/O error occurs.
<code>void write(byte[] b)</code>	Writes <code>b.length</code> bytes from byte array <code>b</code> to this output stream. In general, <code>write(b)</code> behaves as if you specified <code>write(b, 0, b.length)</code> . This method throws <code>NullPointerException</code> when <code>b</code> is null and <code>IOException</code> when an I/O error occurs.
<code>void write(byte[] b, int off, int len)</code>	Writes <code>len</code> bytes from byte array <code>b</code> starting at offset <code>off</code> to this output stream. This method throws <code>NullPointerException</code> when <code>b</code> is null; <code>java.lang.IndexOutOfBoundsException</code> when <code>off</code> is negative, <code>len</code> is negative, or <code>off + len</code> is greater than <code>b.length</code> ; and <code>IOException</code> when an I/O error occurs.
<code>void write(int b)</code>	Writes byte <code>b</code> to this output stream. Only the 8 low-order bits are written; the 24 high-order bits are ignored. This method throws <code>IOException</code> when an I/O error occurs.

The `flush()` method is useful in a long-running application where you need to save changes every so often, as in the previously mentioned text-editor application that saves changes to a temporary file every few minutes. Remember that `flush()` only flushes bytes to the platform; doing so doesn't necessarily result in the platform flushing these bytes to the disk.

**Note** The `close()` method automatically flushes the output stream. If an application ends before `close()` is called, the output stream is automatically closed and its data is flushed.

`InputStream` is the superclass of all input stream subclasses. Table 11-8 describes `InputStream`'s methods.



**Table 11-8. InputStream Methods**

Method	Description
<code>int available()</code>	Returns an estimate of the number of bytes that can be read from this input stream via the next <code>read()</code> method call (or skipped over via <code>skip()</code> ) without blocking the calling thread. This method throws <code>IOException</code> when an I/O error occurs.  It's never correct to use this method's return value to allocate a buffer for holding all of the stream's data because a subclass might not return the total size of the stream.
<code>void close()</code>	Closes this input stream and releases any platform resources associated with the stream. This method throws <code>IOException</code> when an I/O error occurs.
<code>void mark(int readlimit)</code>	Marks the current position in this input stream. A subsequent call to <code>reset()</code> repositions this stream to the last marked position so that subsequent read operations re-read the same bytes. The <code>readlimit</code> argument tells this input stream to allow that many bytes to be read before invalidating this mark (so that the stream cannot be reset to the marked position).
<code>boolean markSupported()</code>	Returns true when this input stream supports <code>mark()</code> and <code>reset()</code> ; otherwise, returns false.
<code>int read()</code>	Reads and returns (as an <code>int</code> in the range 0 to 255) the next byte from this input stream, or returns -1 when the end of the stream is reached. This method blocks until input is available, the end of the stream is detected, or an exception is thrown. It throws <code>IOException</code> when an I/O error occurs.
<code>int read(byte[] b)</code>	Reads some number of bytes from this input stream and stores them in byte array <code>b</code> . Returns the number of bytes actually read (which might be less than <code>b</code> 's length but is never more than this length), or returns -1 when the end of the stream is reached (no byte is available to read). This method blocks until input is available, the end of the stream is detected, or an exception is thrown. It throws <code>NullPointerException</code> when <code>b</code> is null and <code>IOException</code> when an I/O error occurs.
<code>int read(byte[] b, int off, int len)</code>	Reads no more than <code>len</code> bytes from this input stream and stores them in byte array <code>b</code> , starting at the offset specified by <code>off</code> . Returns the number of bytes actually read (which might be less than <code>len</code> but is never more than <code>len</code> ), or returns -1 when the end of the stream is reached (no byte is available to read). This method blocks until input is available, the end of the stream is detected, or an exception is thrown. It throws <code>NullPointerException</code> when <code>b</code> is null; <code>IndexOutOfBoundsException</code> when <code>off</code> is negative, <code>len</code> is negative, or <code>len</code> is greater than <code>b.length - off</code> ; and <code>IOException</code> when an I/O error occurs.
<code>void reset()</code>	Repositions this input stream to the position at the time <code>mark()</code> was last called. This method throws <code>IOException</code> when this input stream has not been marked or the mark has been invalidated.
<code>long skip(long n)</code>	Skips over and discards <code>n</code> bytes of data from this input stream. This method might skip over some smaller number of bytes (possibly zero), for example, when the end of the file is reached before <code>n</code> bytes have been skipped. The actual number of bytes skipped is returned. When <code>n</code> is negative, no bytes are skipped. This method throws <code>IOException</code> when this input stream doesn't support skipping or when some other I/O error occurs.

InputStream subclasses such as `ByteArrayInputStream` support marking the current read position in the input stream via the `mark()` method and later return to that position via the `reset()` method.

**Caution** Don't forget to call `markSupported()` to find out if the subclass supports `mark()` and `reset()`.

## ByteArrayOutputStream and ByteArrayInputStream

Byte arrays are often useful as stream destinations and sources. The `ByteArrayOutputStream` class lets you write a stream of bytes to a byte array; the `ByteArrayInputStream` class lets you read a stream of bytes from a byte array.

`ByteArrayOutputStream` declares two constructors. Each constructor creates a byte array output stream with an internal byte array; a copy of this array can be returned by calling `ByteArrayOutputStream`'s `byte[] toByteArray()` method.

- `ByteArrayOutputStream()` creates a byte array output stream with an internal byte array whose initial size is 32 bytes. This array grows as necessary.
- `ByteArrayOutputStream(int size)` creates a byte array output stream with an internal byte array whose initial size is specified by `size` and grows as necessary. This constructor throws `IllegalArgumentException` when `size` is less than zero.

The following example uses `ByteArrayOutputStream()` to create a byte array output stream with an internal byte array set to the default size:

```
ByteArrayOutputStream baos = new ByteArrayOutputStream();
```

`ByteArrayInputStream` also declares a pair of constructors. Each constructor creates a byte array input stream based on the specified byte array and also keeps track of the next byte to read from the array and the number of bytes to read.

- `ByteArrayInputStream(byte[] ba)` creates a byte array input stream that uses `ba` as its byte array (`ba` is used directly; a copy isn't created). The position is set to 0 and the number of bytes to read is set to `ba.length`.
- `ByteArrayInputStream(byte[] ba, int offset, int count)` creates a byte array input stream that uses `ba` as its byte array (no copy is made). The position is set to `offset` and the number of bytes to read is set to `count`.

The following example uses `ByteArrayInputStream(byte[])` to create a byte array input stream whose source is a copy of the previous byte array output stream's byte array:

```
ByteArrayInputStream bais = new ByteArrayInputStream(baos.toByteArray());
```

`ByteArrayOutputStream` and `ByteArrayInputStream` are useful in a scenario where you need to convert an image to an array of bytes, process these bytes in some manner, and convert the bytes back to the image.

For example, suppose you're writing an Android-based image-processing application. You decode a file containing the image into an Android-specific `android.graphics.Bitmap` instance, compress this instance into a `ByteArrayOutputStream` instance, obtain a copy of the byte array output stream's array, process this array in some manner, convert this array to a `ByteArrayInputStream` instance, and use the byte array input stream to decode these bytes into another `Bitmap` instance, as follows:

```
String pathname = ...; // Assume a legitimate pathname to an image.
Bitmap bm = BitmapFactory.decodeFile(pathname);
ByteArrayOutputStream baos = new ByteArrayOutputStream();
if (bm.compress(Bitmap.CompressFormat.PNG, 100, baos))
{
    byte[] imageBytes = baos.toByteArray();
    // Do something with imageBytes.
    bm = BitmapFactory.decodeStream(new ByteArrayInputStream(imageBytes));
}
```

This example obtains an image file's pathname and then calls the concrete `android.graphics.BitmapFactory` class's `Bitmap decodeFile(String pathname)` class method. This method decodes the image file identified by `pathname` into a bitmap and returns a `Bitmap` instance that represents this bitmap.

After creating a `ByteArrayOutputStream` object, the example uses the returned `Bitmap` instance to call `Bitmap`'s boolean `compress(Bitmap.CompressFormat format, int quality, OutputStream stream)` method to write a compressed version of the bitmap to the byte array output stream:

- `format` identifies the format of the compressed image. I've chosen to use the popular Portable Network Graphics (PNG) format.
- `quality` hints to the compressor as to how much compression is required. This value ranges from 0 through 100, where 0 means maximum compression at the expense of quality and 100 means maximum quality at the expense of compression. Formats such as PNG ignore quality because they employ lossless compression.
- `stream` identifies the stream on which to write the compressed image data.

When `compress()` returns true, which means that it successfully compressed the image onto the byte array output stream in the PNG format, the `ByteArrayOutputStream` object's `toByteArray()` method is called to create and return a byte array with the image's bytes.

Continuing, the array is processed, a `ByteArrayInputStream` object is created with the processed bytes serving as the source of this stream, and `BitmapFactory`'s `Bitmap decodeStream(InputStream is)` class method is called to convert the byte array input stream's source of bytes to a `Bitmap` instance.

## FileOutputStream and FileInputStream

Files are common stream destinations and sources. The concrete `FileOutputStream` class lets you write a stream of bytes to a file; the concrete `FileInputStream` class lets you read a stream of bytes from a file.

`FileOutputStream` subclasses `OutputStream` and declares five constructors for creating file output streams. For example, `FileOutputStream(String name)` creates a file output stream to the existing file identified by name. This constructor throws `FileNotFoundException` when the file doesn't exist and cannot be created, it is a directory rather than a normal file, or there is some other reason why the file cannot be opened for output.

The following example uses `FileOutputStream(String pathname)` to create a file output stream with `employee.dat` as its destination:

```
FileOutputStream fos = new FileOutputStream("employee.dat");
```

**Tip** `FileOutputStream(String name)` overwrites an existing file. To append data instead of overwriting existing content, call a `FileOutputStream` constructor that includes a boolean `append` parameter and pass `true` to this parameter.

`FileInputStream` subclasses `InputStream` and declares three constructors for creating file input streams. For example, `FileInputStream(String name)` creates a file input stream from the existing file identified by name. This constructor throws `FileNotFoundException` when the file doesn't exist, it is a directory rather than a normal file, or there is some other reason for why the file cannot be opened for input.

The following example uses `FileInputStream(String name)` to create a file input stream with `employee.dat` as its source:

```
FileInputStream fis = new FileInputStream("employee.dat");
```

`FileOutputStream` and `FileInputStream` are useful in a file-copying context. Listing 11-11 presents the source code to a `Copy` application that provides a demonstration.

*Listing 11-11. Copying a Source File to a Destination File*

```
import java.io.FileInputStream;
import java.io.FileNotFoundException;
import java.io.FileOutputStream;
import java.io.IOException;

public class Copy
{
    public static void main(String[] args)
    {
        if (args.length != 2)
        {
            System.err.println("usage: java Copy srcfile dstfile");
            return;
        }
        FileInputStream fis = null;
        FileOutputStream fos = null;
```

```

try
{
    fis = new FileInputStream(args[0]);
    fos = new FileOutputStream(args[1]);
    int b; // I chose b instead of byte because byte is a reserved word.
    while ((b = fis.read()) != -1)
        fos.write(b);
}
catch (FileNotFoundException fnfe)
{
    System.err.println(args[0] + " could not be opened for input, or " +
        args[1] + " could not be created for output");
}
catch (IOException ioe)
{
    System.err.println("I/O error: " + ioe.getMessage());
}
finally
{
    if (fis != null)
        try
        {
            fis.close();
        }
        catch (IOException ioe)
        {
            assert false; // shouldn't happen in this context
        }

    if (fos != null)
        try
        {
            fos.close();
        }
        catch (IOException ioe)
        {
            assert false; // shouldn't happen in this context
        }
}
}
}

```

Listing 11-11's `main()` method first verifies that two command-line arguments, identifying the names of source and destination files, are specified. It then proceeds to instantiate `FileInputStream` and `FileOutputStream` and enter a while loop that repeatedly reads bytes from the file input stream and writes them to the file output stream.

Of course something might go wrong. Perhaps the source file doesn't exist, or perhaps the destination file cannot be created (a same-named read-only file might exist, for example). In either scenario, `FileNotFoundException` is thrown and must be handled. Another possibility is that an I/O error occurred during the copy operation. Such an error results in `IOException`.

Regardless of an exception being thrown or not, the input and output streams are closed via the `finally` block. In a simple application like this, I could ignore the `close()` method calls and let the application terminate. Although Java automatically closes open files at this point, it's good form to explicitly close files upon exit.

Because `close()` is capable of throwing an instance of the checked `IOException` class, a call to this method is wrapped in a `try` block with an appropriate `catch` block that catches this exception. Notice the `if` statement that precedes each `try` block. This statement is necessary to avoid a thrown `NullPointerException` instance should either `fis` or `fos` contain the null reference.

## PipedOutputStream and PipedInputStream

Threads must often communicate. One approach involves using shared variables. Another approach involves using piped streams via the `PipedOutputStream` and `PipedInputStream` classes. The `PipedOutputStream` class lets a sending thread write a stream of bytes to an instance of the `PipedInputStream` class, which a receiving thread uses to subsequently read those bytes.

**Caution** Attempting to use a `PipedOutputStream` object and a `PipedInputStream` object from a single thread is not recommended because it might deadlock the thread.

`PipedOutputStream` declares a pair of constructors for creating piped output streams:

- `PipedOutputStream()` creates a piped output stream that's not yet connected to a piped input stream. It must be connected to a piped input stream, either by the receiver or the sender, before being used.
- `PipedOutputStream(PipedInputStream dest)` creates a piped output stream that's connected to piped input stream `dest`. Bytes written to the piped output stream can be read from `dest`. This constructor throws `IOException` when an I/O error occurs.

`PipedOutputStream` declares a `void connect(PipedInputStream dest)` method that connects this piped output stream to `dest`. This method throws `IOException` when this piped output stream is already connected to another piped input stream.

`PipedInputStream` declares four constructors for creating piped input streams:

- `PipedInputStream()` creates a piped input stream that's not yet connected to a piped output stream. It must be connected to a piped output stream before being used.
- `PipedInputStream(int pipeSize)` creates a piped input stream that's not yet connected to a piped output stream and uses `pipeSize` to size the piped input stream's buffer. It must be connected to a piped output stream before being used. This constructor throws `IllegalArgumentException` when `pipeSize` is less than or equal to 0.

- `PipedInputStream(PipedOutputStream src)` creates a piped input stream that's connected to piped output stream `src`. Bytes written to `src` can be read from this piped input stream. This constructor throws `IOException` when an I/O error occurs.
- `PipedInputStream(PipedOutputStream src, int pipeSize)` creates a piped input stream that's connected to piped output stream `src` and uses `pipeSize` to size the piped input stream's buffer. Bytes written to `src` can be read from this piped input stream. This constructor throws `IOException` when an I/O error occurs and `IllegalArgumentException` when `pipeSize` is less than or equal to 0.

`PipedInputStream` declares a `void connect(PipedOutputStream src)` method that connects this piped input stream to `src`. This method throws `IOException` when this piped input stream is already connected to another piped output stream.

The easiest way to create a pair of piped streams is in the same thread and in either order. For example, you can first create the piped output stream.

```
PipedOutputStream pos = new PipedOutputStream();
PipedInputStream pis = new PipedInputStream(pos);
```

Alternatively, you can first create the piped input stream.

```
PipedInputStream pis = new PipedInputStream();
PipedOutputStream pos = new PipedOutputStream(pis);
```

You can leave both streams unconnected and later connect them to each other using the appropriate piped stream's `connect()` method, as follows:

```
PipedOutputStream pos = new PipedOutputStream();
PipedInputStream pis = new PipedInputStream();
// ...
pos.connect(pis);
```

Listing 11-12 presents a `PipedStreamsDemo` application whose sender thread streams a sequence of randomly generated byte integers to a receiver thread, which outputs this sequence.

*Listing 11-12. Piping Randomly Generated Bytes from a Sender Thread to a Receiver Thread*

```
import java.io.IOException;
import java.io.PipedInputStream;
import java.io.PipedOutputStream;

public class PipedStreamsDemo
{
    public static void main(String[] args) throws IOException
    {
        final PipedOutputStream pos = new PipedOutputStream();
        final PipedInputStream pis = new PipedInputStream(pos);
```

```
Runnable senderTask = new Runnable()
{
    final static int LIMIT = 10;

    @Override
    public void run()
    {
        try
        {
            for (int i = 0 ; i < LIMIT; i++)
                pos.write((byte) (Math.random() * 256));
        }
        catch (IOException ioe)
        {
            ioe.printStackTrace();
        }
        finally
        {
            try
            {
                pos.close();
            }
            catch (IOException ioe)
            {
                ioe.printStackTrace();
            }
        }
    }
};

Runnable receiverTask = new Runnable()
{
    @Override
    public void run()
    {
        try
        {
            int b;
            while ((b = pis.read()) != -1)
                System.out.println(b);
        }
        catch (IOException ioe)
        {
            ioe.printStackTrace();
        }
        finally
        {
            try
            {
                pis.close();
            }
        }
    }
}
```



```

        catch (IOException ioe)
        {
            ioe.printStackTrace();
        }
    }
};
Thread sender = new Thread(senderTask);
Thread receiver = new Thread(receiverTask);
sender.start();
receiver.start();
}
}

```

Listing 11-12's `main()` method creates piped output and piped input streams that will be used by the `senderTask` thread to communicate a sequence of randomly generated byte integers and by the `receiverTask` thread to receive this sequence.

The sender task's `run()` method explicitly closes its pipe stream when it finishes sending the data. If it didn't do this, an `IOException` instance with a "write end dead" message would be thrown when the receiver thread invoked `read()` for the final time (which would otherwise return -1 to indicate end of stream). For more information on this message, check out Daniel Ferber's "Whats this? `IOException: Write end dead`" blog post (<http://techtavern.wordpress.com/2008/07/16/whats-this-ioexception-write-end-dead/>).

Compile Listing 11-12 (`javac PipedStreamsDemo.java`) and run this application (`java PipedStreamsDemo`). You'll discover output similar to the following:

```

93
23
125
50
126
131
210
29
150
91

```

## FilterOutputStream and FilterInputStream

Byte array, file, and piped streams pass bytes unchanged to their destinations. Java also supports *filter streams* that buffer, compress/uncompress, encrypt/decrypt, or otherwise manipulate a stream's byte sequence (that is input to the filter) before it reaches its destination.

A *filter output stream* takes the data passed to its `write()` methods (the input stream), filters it, and writes the filtered data to an underlying output stream, which might be another filter output stream or a destination output stream such as a file output stream.

Filter output streams are created from subclasses of the concrete `FilterOutputStream` class, an `OutputStream` subclass. `FilterOutputStream` declares a single `FilterOutputStream(OutputStream out)` constructor that creates a filter output stream built on top of `out`, the underlying output stream.

Listing 11-13 reveals that it's easy to subclass `FilterOutputStream`. At minimum, you declare a constructor that passes its `OutputStream` argument to `FilterOutputStream`'s constructor and override `FilterOutputStream`'s `write(int)` method.

*Listing 11-13. Scrambling a Stream of Bytes*

```
import java.io.FilterOutputStream;
import java.io.IOException;
import java.io.OutputStream;

public class ScrambledOutputStream extends FilterOutputStream
{
    private int[] map;

    public ScrambledOutputStream(OutputStream out, int[] map)
    {
        super(out);
        if (map == null)
            throw new NullPointerException("map is null");
        if (map.length != 256)
            throw new IllegalArgumentException("map.length != 256");
        this.map = map;
    }

    @Override
    public void write(int b) throws IOException
    {
        out.write(map[b]);
    }
}
```

Listing 11-13 presents a `ScrambledOutputStream` class that performs trivial encryption on its input stream by scrambling the input stream's bytes via a remapping operation. This constructor takes a pair of arguments:

- `out` identifies the output stream on which to write the scrambled bytes.
- `map` identifies an array of 256 byte-integer values to which input stream bytes map.

The constructor first passes its `out` argument to the `FilterOutputStream` parent via a `super(out)` call. It then verifies its `map` argument's integrity (`map` must be nonnull and have a length of 256: a byte stream offers exactly 256 bytes to map) before saving `map`.

The `write(int)` method is trivial: it calls the underlying output stream's `write(int)` method with the byte to which argument `b` maps. `FilterOutputStream` declares `out` to be protected (for performance), which is why I can directly access this field.

**Note** It's only essential to override `write(int)` because `FilterOutputStream`'s other two `write()` methods are implemented via this method.

Listing 11-14 presents the source code to a Scramble application for experimenting with scrambling a source file's bytes via `ScrambledOutputStream` and writing these scrambled bytes to a destination file.

*Listing 11-14. Scrambling a File's Bytes*

```
import java.io.FileInputStream;
import java.io.FileOutputStream;
import java.io.IOException;

import java.util.Random;

public class Scramble
{
    public static void main(String[] args)
    {
        if (args.length != 2)
        {
            System.err.println("usage: java Scramble srcpath destpath");
            return;
        }
        FileInputStream fis = null;
        ScrambledOutputStream sos = null;
        try
        {
            fis = new FileInputStream(args[0]);
            FileOutputStream fos = new FileOutputStream(args[1]);
            sos = new ScrambledOutputStream(fos, makeMap());
            int b;
            while ((b = fis.read()) != -1)
                sos.write(b);
        }
        catch (IOException ioe)
        {
            ioe.printStackTrace();
        }
        finally
        {
            if (fis != null)
                try
                {
                    fis.close();
                }
                catch (IOException ioe)
                {
                    ioe.printStackTrace();
                }
            if (sos != null)
                try
                {
                    sos.close();
                }
        }
    }
}
```

```

        catch (IOException ioe)
        {
            ioe.printStackTrace();
        }
    }

    static int[] makeMap()
    {
        int[] map = new int[256];
        for (int i = 0; i < map.length; i++)
            map[i] = i;
        // Shuffle map.
        Random r = new Random(0);
        for (int i = 0; i < map.length; i++)
        {
            int n = r.nextInt(map.length);
            int temp = map[i];
            map[i] = map[n];
            map[n] = temp;
        }
        return map;
    }
}

```

Scramble's `main()` method first verifies the number of command-line arguments: the first argument identifies the source path of the file with unscrambled content; the second argument identifies the destination path of the file that stores scrambled content.

Assuming that two command-line arguments have been specified, `main()` instantiates `FileInputStream`, creating a file input stream that's connected to the file identified by `args[0]`.

Continuing, `main()` instantiates `FileOutputStream`, creating a file output stream that's connected to the file identified by `args[1]`. It then instantiates `ScrambledOutputStream` and passes the `FileOutputStream` instance to `ScrambledOutputStream`'s constructor.

**Note** When a stream instance is passed to another stream class's constructor, the two streams are *chained together*. For example, the scrambled output stream is chained to the file output stream.

`main()` now enters a loop, reading bytes from the file input stream and writing them to the scrambled output stream by calling `ScrambledOutputStream`'s `write(int)` method. This loop continues until `FileInputStream`'s `read()` method returns `-1` (end of file).

The finally block closes the file input stream and scrambled output stream by calling their `close()` methods. It doesn't call the file output stream's `close()` method because `FilterOutputStream` automatically calls the underlying output stream's `close()` method.

The `makeMap()` method is responsible for creating the map array that's passed to `ScrambledOutputStream`'s constructor. The idea is to populate the array with all 256 byte-integer values, storing them in random order.

**Note** I pass 0 as the seed argument when creating the `java.util.Random` object in order to return a predictable sequence of random numbers. I need to use the same sequence of random numbers when creating the complementary map array in the `Unscramble` application, which I will present shortly. Unscrambling will not work without the same sequence.

Suppose you have a simple 15-byte file named `hello.txt` that contains “Hello, World!” (followed by a carriage return and a line feed). If you execute `java Scramble hello.txt hello.out` on a Windows 7 platform, you’ll observe Figure 11-5’s scrambled output.

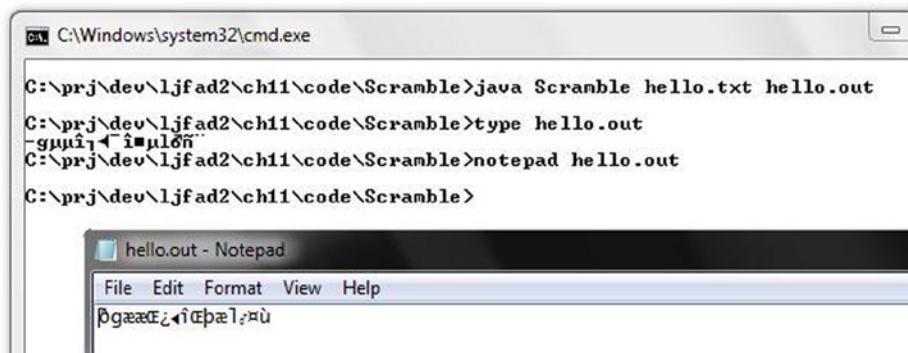

**Figure 11-5.** Different fonts yield different-looking scrambled output

A *filter input stream* takes the data obtained from its underlying input stream—which might be another filter input stream or a source input stream such as a file input stream—filters it, and makes this data available via its `read()` methods (the output stream).

Filter input streams are created from subclasses of the concrete `FilterInputStream` class, an `InputStream` subclass. `FilterInputStream` declares a single `FilterInputStream(InputStream in)` constructor that creates a filter input stream built on top of `in`, the underlying input stream.

Listing 11-15 shows that it’s easy to subclass `FilterInputStream`. At minimum, declare a constructor that passes its `InputStream` argument to `FilterInputStream`’s constructor and override `FilterInputStream`’s `read()` and `read(byte[], int, int)` methods.

**Listing 11-15.** *Unscrambling a Stream of Bytes*

```
import java.io.FilterInputStream;
import java.io.InputStream;
import java.io.IOException;

public class ScrambledInputStream extends FilterInputStream
{
    private int[] map;
```

```

public ScrambledInputStream(InputStream in, int[] map)
{
    super(in);
    if (map == null)
        throw new NullPointerException("map is null");
    if (map.length != 256)
        throw new IllegalArgumentException("map.length != 256");
    this.map = map;
}

@Override
public int read() throws IOException
{
    int value = in.read();
    return (value == -1) ? -1 : map[value];
}

@Override
public int read(byte[] b, int off, int len) throws IOException
{
    int nBytes = in.read(b, off, len);
    if (nBytes <= 0)
        return nBytes;
    for (int i = 0; i < nBytes; i++)
        b[off + i] = (byte) map[off + i];
    return nBytes;
}
}

```

Listing 11-15 presents a `ScrambledInputStream` class that performs trivial decryption on its underlying input stream by unscrambling the underlying input stream's scrambled bytes via a remapping operation.

The `read()` method first reads the scrambled byte from its underlying input stream. If the returned value is `-1` (end of file), this value is returned to its caller. Otherwise, the byte is mapped to its unscrambled value, which is returned.

The `read(byte[], int, int)` method is similar to `read()`, but stores bytes read from the underlying input stream in a byte array, taking an offset into this array and a length (number of bytes to read) into account.

Once again, `-1` might be returned from the underlying `read()` method call. If so, this value must be returned. Otherwise, each byte in the array is mapped to its unscrambled value, and the number of bytes read is returned.

**Note** It's only essential to override `read()` and `read(byte[], int, int)` because `FilterInputStream`'s `read(byte[])` method is implemented via the latter method.

Listing 11-16 presents the source code to an Unscramble application for experimenting with ScrambledInputStream by unscrambling a source file's bytes and writing these unscrambled bytes to a destination file.

*Listing 11-16. Unscrambling a File's Bytes*

```
import java.io.FileInputStream;
import java.io.FileOutputStream;
import java.io.IOException;

import java.util.Random;

public class Unscramble
{
    public static void main(String[] args)
    {
        if (args.length != 2)
        {
            System.err.println("usage: java Unscramble srcpath destpath");
            return;
        }
        ScrambledInputStream sis = null;
        FileOutputStream fos = null;
        try
        {
            FileInputStream fis = new FileInputStream(args[0]);
            sis = new ScrambledInputStream(fis, makeMap());
            fos = new FileOutputStream(args[1]);
            int b;
            while ((b = sis.read()) != -1)
                fos.write(b);
        }
        catch (IOException ioe)
        {
            ioe.printStackTrace();
        }
        finally
        {
            if (sis != null)
                try
                {
                    sis.close();
                }
                catch (IOException ioe)
                {
                    ioe.printStackTrace();
                }
            if (fos != null)
                try
                {
                    fos.close();
                }
        }
    }
}
```

```

        catch (IOException ioe)
        {
            ioe.printStackTrace();
        }
    }

    static int[] makeMap()
    {
        int[] map = new int[256];
        for (int i = 0; i < map.length; i++)
            map[i] = i;
        // Shuffle map.
        Random r = new Random(0);
        for (int i = 0; i < map.length; i++)
        {
            int n = r.nextInt(map.length);
            int temp = map[i];
            map[i] = map[n];
            map[n] = temp;
        }
        int[] temp = new int[256];
        for (int i = 0; i < temp.length; i++)
            temp[map[i]] = i;
        return temp;
    }
}

```

Unscramble's `main()` method first verifies the number of command-line arguments: the first argument identifies the source path of the file with scrambled content; the second argument identifies the destination path of the file that stores unscrambled content.

Assuming that two command-line arguments have been specified, `main()` instantiates `FileInputStream`, creating a file input stream that's connected to the file identified by `args[1]`.

Continuing, `main()` instantiates `FileInputStream`, creating a file input stream that's connected to the file identified by `args[0]`. It then instantiates `ScrambledInputStream`, and passes the `FileInputStream` instance to `ScrambledInputStream`'s constructor.

**Note** When a stream instance is passed to another stream class's constructor, the two streams are *chained together*. For example, the scrambled input stream is chained to the file input stream.

`main()` now enters a loop, reading bytes from the scrambled input stream and writing them to the file output stream. This loop continues until `ScrambledInputStream`'s `read()` method returns -1 (end of file).

The finally block closes the scrambled input stream and file output stream by calling their `close()` methods. It doesn't call the file input stream's `close()` method because `FilterOutputStream` automatically calls the underlying input stream's `close()` method.



The `makeMap()` method is responsible for creating the map array that's passed to `ScrambledInputStream`'s constructor. The idea is to duplicate Listing 11-14's map array and then invert it so that unscrambling can be performed.

Continuing from the previous `hello.txt/hello.out` example, execute `java Unscramble hello.out hello.bak` and you'll see the same unscrambled content in `hello.bak` that's present in `hello.txt`.

**Note** For an additional example of a filter output stream and its complementary filter input stream, check out the “Extending Java Streams to Support Bit Streams” article ([www.drdobbs.com/184410423](http://www.drdobbs.com/184410423)) on the Dr. Dobb's web site. This article introduces `BitStreamOutputStream` and `BitStreamInputStream` classes that are useful for outputting and inputting bit streams. The article then demonstrates these classes in a Java implementation of the Lempel-Zif-Welch (LZW) data compression and decompression algorithm.

## BufferedOutputStream and BufferedInputStream

`FileOutputStream` and `FileInputStream` have a performance problem. Each file output stream `write()` method call and file input stream `read()` method call results in a call to one of the underlying platform's native methods, and these native calls slow down I/O.

**Note** A *native method* is an underlying platform API function that Java connects to an application via the *Java Native Interface (JNI)*. Java supplies reserved word `native` to identify a native method. For example, the `RandomAccessFile` class declares a `private native void open(String name, int mode)` method. When a `RandomAccessFile` constructor calls this method, Java asks the underlying platform (via the JNI) to open the specified file in the specified mode on Java's behalf. I discuss the JNI in Chapter 16.

The concrete `BufferedOutputStream` and `BufferedInputStream` filter stream classes improve performance by minimizing underlying output stream `write()` and underlying input stream `read()` method calls. Instead, calls to `BufferedOutputStream`'s `write()` and `BufferedInputStream`'s `read()` methods take Java buffers into account.

- When a write buffer is full, `write()` calls the underlying output stream `write()` method to empty the buffer. Subsequent calls to `BufferedOutputStream`'s `write()` methods store bytes in this buffer until it's once again full.
- When the read buffer is empty, `read()` calls the underlying input stream `read()` method to fill the buffer. Subsequent calls to `BufferedInputStream`'s `read()` methods return bytes from this buffer until it's once again empty.

`BufferedOutputStream` declares the following constructors:

- `BufferedOutputStream(OutputStream out)` creates a buffered output stream that streams its output to `out`. An internal buffer is created to store bytes written to `out`.
- `BufferedOutputStream(OutputStream out, int size)` creates a buffered output stream that streams its output to `out`. An internal buffer of length `size` is created to store bytes written to `out`.

The following example chains a `BufferedOutputStream` instance to a `FileOutputStream` instance. Subsequent `write()` method calls on the `BufferedOutputStream` instance buffer bytes and occasionally result in internal `write()` method calls on the encapsulated `FileOutputStream` instance.

```
FileOutputStream fos = new FileOutputStream("employee.dat");
BufferedOutputStream bos = new BufferedOutputStream(fos); // Chain bos to fos.
bos.write(0); // Write to employee.dat through the buffer.
// Additional write() method calls.
bos.close(); // This method call internally calls fos's close() method.
```

`BufferedInputStream` declares the following constructors:

- `BufferedInputStream(InputStream in)` creates a buffered input stream that streams its input from `in`. An internal buffer is created to store bytes read from `in`.
- `BufferedInputStream(InputStream in, int size)` creates a buffered input stream that streams its input from `in`. An internal buffer of length `size` is created to store bytes read from `in`.

The following example chains a `BufferedInputStream` instance to a `FileInputStream` instance. Subsequent `read()` method calls on the `BufferedInputStream` instance unbuffer bytes and occasionally result in internal `read()` method calls on the encapsulated `FileInputStream` instance.

```
FileInputStream fis = new FileInputStream("employee.dat");
BufferedInputStream bis = new BufferedInputStream(fis); // Chain bis to fis.
int ch = bis.read(); // Read employee.dat through the buffer.
// Additional read() method calls.
bis.close(); // This method call internally calls fis's close() method.
```

## DataOutputStream and DataInputStream

`FileOutputStream` and `FileInputStream` are useful for writing and reading bytes and arrays of bytes. However, they provide no support for writing and reading primitive type values (such as integers) and strings.

For this reason, Java provides the concrete `DataOutputStream` and `DataInputStream` filter stream classes. Each class overcomes this limitation by providing methods to write or read primitive type values and strings in a platform-independent way.

- Integer values are written and read in *big-endian format* (the most significant byte comes first). Check out Wikipedia's "Endianness" entry (<http://en.wikipedia.org/wiki/Endianness>) to learn about the concept of *endianness*.
- Floating-point and double precision floating-point values are written and read according to the IEEE 754 standard, which specifies 4 bytes per floating-point value and 8 bytes per double precision floating-point value.
- Strings are written and read according to a modified version of *UTF-8*, a variable-length encoding standard for efficiently storing 2-byte Unicode characters. Check out Wikipedia's "UTF-8" entry (<http://en.wikipedia.org/wiki/Utf-8>) to learn more about UTF-8.

`DataOutputStream` declares a single `DataOutputStream(OutputStream out)` constructor. Because this class implements the `DataOutput` interface, `DataOutputStream` also provides access to the same-named write methods as provided by `RandomAccessFile`.

`DataInputStream` declares a single `DataInputStream(InputStream in)` constructor. Because this class implements the `DataInput` interface, `DataInputStream` also provides access to the same-named read methods as provided by `RandomAccessFile`.

Listing 11-17 presents the source code to a `DataStreamsDemo` application that uses a `DataOutputStream` instance to write multibyte values to a `FileOutputStream` instance and uses a `DataInputStream` instance to read multibyte values from a `FileInputStream` instance.

*Listing 11-17. Outputting and Then Inputting a Stream of Multibyte Values*

```
import java.io.DataInputStream;
import java.io.DataOutputStream;
import java.io.FileInputStream;
import java.io.FileOutputStream;
import java.io.IOException;

public class DataStreamsDemo
{
    final static String FILENAME = "values.dat";

    public static void main(String[] args)
    {
        DataOutputStream dos = null;
        DataInputStream dis = null;
        try
        {
            FileOutputStream fos = new FileOutputStream(FILENAME);
            dos = new DataOutputStream(fos);
            dos.writeInt(1995);
            dos.writeUTF("Saving this String in modified UTF-8 format!");
            dos.writeFloat(1.0F);
            dos.close(); // Close underlying file output stream.
            // The following null assignment prevents another close attempt on
            // dos (which is now closed) should IOException be thrown from
            // subsequent method calls.
            dos = null;
            FileInputStream fis = new FileInputStream(FILENAME);
            dis = new DataInputStream(fis);
            System.out.println(dis.readInt());
            System.out.println(dis.readUTF());
            System.out.println(dis.readFloat());
        }
        catch (IOException ioe)
        {
            System.err.println("I/O error: " + ioe.getMessage());
        }
    }
}
```

```

finally
{
    if (dos != null)
        try
        {
            dos.close();
        }
        catch (IOException ioe2) // Cannot redeclare local variable ioe.
        {
            assert false; // shouldn't happen in this context
        }
    if (dis != null)
        try
        {
            dis.close();
        }
        catch (IOException ioe2) // Cannot redeclare local variable ioe.
        {
            assert false; // shouldn't happen in this context
        }
    }
}
}

```

`DataStreamDemo` creates a file named `values.dat`; calls `DataOutputStream` methods to write an integer, a string, and a floating-point value to this file; and calls `DataInputStream` methods to read back these values. Unsurprisingly, it generates the following output:

```

1995
Saving this String in modified UTF-8 format!
1.0

```

**Caution** When reading a file of values written by a sequence of `DataOutputStream` method calls, make sure to use the same method-call sequence. Otherwise, you're bound to end up with erroneous data and, in the case of the `readUTF()` methods, thrown instances of the `java.io.UTFDataFormatException` class (a subclass of `IOException`).

## Object Serialization and Deserialization

Java provides the `DataOutputStream` and `DataInputStream` classes to stream primitive type values and `String` objects. However, you cannot use these classes to stream non-`String` objects. Instead, you must use object serialization and deserialization to stream objects of arbitrary types.

*Object serialization* is a virtual machine mechanism for *serializing* object state into a stream of bytes. Its *deserialization* counterpart is a virtual machine mechanism for *deserializing* this state from a byte stream.

**Note** An object's state consists of instance fields that store primitive-type values and/or references to other objects. When an object is serialized, the objects that are part of this state are also serialized (unless you prevent them from being serialized). Furthermore, the objects that are part of those objects' states are serialized (unless you prevent this), and so on.

Java supports default serialization and deserialization, custom serialization and deserialization, and externalization.

## Default Serialization and Deserialization

Default serialization and deserialization is the easiest form to use but offers little control over how objects are serialized and deserialized. Although Java handles most of the work on your behalf, there are a couple of tasks that you must perform.

Your first task is to have the class of the object that's to be serialized implement the `java.io.Serializable` interface, either directly or indirectly via the class's superclass. The rationale for implementing `Serializable` is to avoid unlimited serialization.

**Note** `Serializable` is an empty marker interface (there are no methods to implement) that a class implements to tell the virtual machine that it's okay to serialize the class's objects. When the serialization mechanism encounters an object whose class doesn't implement `Serializable`, it throws an instance of the `java.io.NotSerializableException` class (an indirect subclass of `IOException`).

*Unlimited serialization* is the process of serializing an entire object graph. Java doesn't support unlimited serialization for the following reasons:

- *Security*: If Java automatically serialized an object containing sensitive information (such as a password or a credit card number), it would be easy for a hacker to discover this information and wreak havoc. It's better to give the developer a choice to prevent this from happening.
- *Performance*: Serialization leverages the Reflection API (discussed in Chapter 8), which tends to slow down application performance. Unlimited serialization could really hurt an application's performance.
- *Objects not amenable to serialization*: Some objects exist only in the context of a running application and it's meaningless to serialize them. For example, a file stream object that's deserialized no longer represents a connection to a file.

Listing 11-18 declares an `Employee` class that implements the `Serializable` interface to tell the virtual machine that it's okay to serialize `Employee` objects.

*Listing 11-18. Implementing Serializable*

```
import java.io.Serializable;

public class Employee implements Serializable
{
    private String name;
    private int age;

    public Employee(String name, int age)
    {
        this.name = name;
        this.age = age;
    }

    public String getName() { return name; }

    public int getAge() { return age; }
}
```

Because `Employee` implements `Serializable`, the serialization mechanism will not throw a `NotSerializableException` instance when serializing an `Employee` object. Not only does `Employee` implement `Serializable`, the `String` class also implements this interface.

Your second task is to work with the `ObjectOutputStream` class and its `writeObject()` method to serialize an object and the `ObjectInputStream` class and its `readObject()` method to deserialize the object.

**Note** Although `ObjectOutputStream` extends `OutputStream` instead of `FilterOutputStream`, and although `ObjectInputStream` extends `InputStream` instead of `FilterInputStream`, these classes behave as filter streams.

Java provides the concrete `ObjectOutputStream` class to initiate the serialization of an object's state to an object output stream. This class declares an `ObjectOutputStream(OutputStream out)` constructor that chains the object output stream to the output stream specified by `out`.

When you pass an output stream reference to `out`, this constructor attempts to write a serialization header to that output stream. It throws `NullPointerException` when `out` is `null` and `IOException` when an I/O error prevents it from writing this header.

`ObjectOutputStream` serializes an object via its `void writeObject(Object obj)` method. This method attempts to write information about `obj`'s class followed by the values of `obj`'s instance fields to the underlying output stream.

`writeObject()` doesn't serialize the contents of static fields. In contrast, it serializes the contents of all instance fields that are not explicitly prefixed with the `transient` reserved word. For example, consider the following field declaration:

```
public transient char[] password;
```

This declaration specifies `transient` to avoid serializing a password for some hacker to encounter. The virtual machine's serialization mechanism ignores any instance field that's marked `transient`.

**Note** Check out my “Transience” blog post ([www.javaworld.com/community/node/13451](http://www.javaworld.com/community/node/13451)) to learn more about `transient`.

`writeObject()` throws `IOException` or an instance of an `IOException` subclass when something goes wrong. For example, this method throws `NotSerializableException` when it encounters an object whose class doesn't implement `Serializable`.

**Note** Because `ObjectOutputStream` implements `DataOutput`, it also declares methods for writing primitive-type values and strings to an object output stream.

Java provides the concrete `ObjectInputStream` class to initiate the deserialization of an object's state from an object input stream. This class declares an `ObjectInputStream(InputStream in)` constructor that chains the object input stream to the input stream specified by `in`.

When you pass an input stream reference to `in`, this constructor attempts to read a serialization header from that input stream. It throws `NullPointerException` when `in` is `null`, `IOException` when an I/O error prevents it from reading this header, and `java.io.StreamCorruptedException` (an indirect subclass of `IOException`) when the stream header is incorrect.

`ObjectInputStream` deserializes an object via its `Object readObject()` method. This method attempts to read information about `obj`'s class followed by the values of `obj`'s instance fields from the underlying input stream.

`readObject()` throws `java.lang.ClassNotFoundException`, `IOException`, or an instance of an `IOException` subclass when something goes wrong. For example, this method throws `java.io.OptionalDataException` when it encounters primitive-type values instead of objects.

**Note** Because `ObjectInputStream` implements `DataInput`, it also declares methods for reading primitive-type values and strings from an object input stream.

Listing 11-19 presents an application that uses these classes to serialize and deserialize an instance of Listing 11-18's `Employee` class to and from an `employee.dat` file.

*Listing 11-19. Serializing and Deserializing an Employee Object*

```
import java.io.FileInputStream;
import java.io.FileOutputStream;
import java.io.IOException;
import java.io.ObjectInputStream;
import java.io.ObjectOutputStream;
```

```
public class SerializationDemo
{
    final static String FILENAME = "employee.dat";

    public static void main(String[] args)
    {
        ObjectOutputStream oos = null;
        ObjectInputStream ois = null;
        try
        {
            FileOutputStream fos = new FileOutputStream(FILENAME);
            oos = new ObjectOutputStream(fos);
            Employee emp = new Employee("John Doe", 36);
            oos.writeObject(emp);
            oos.close();
            oos = null;
            FileInputStream fis = new FileInputStream(FILENAME);
            ois = new ObjectInputStream(fis);
            emp = (Employee) ois.readObject(); // (Employee) cast is necessary.
            ois.close();
            System.out.println(emp.getName());
            System.out.println(emp.getAge());
        }
        catch (ClassNotFoundException cnfe)
        {
            System.err.println(cnfe.getMessage());
        }
        catch (IOException ioe)
        {
            System.err.println(ioe.getMessage());
        }
        finally
        {
            if (oos != null)
            {
                try
                {
                    oos.close();
                }
                catch (IOException ioe)
                {
                    assert false; // shouldn't happen in this context
                }
            }

            if (ois != null)
            {
                try
                {
                    ois.close();
                }
            }
        }
    }
}
```



```

        catch (IOException ioe)
        {
            assert false; // shouldn't happen in this context
        }
    }
}

```

Listing 11-19's `main()` method first instantiates `Employee` and serializes this instance via `writeObject()` to `employee.dat`. It then deserializes this instance from this file via `readObject()` and invokes the instance's `getName()` and `getAge()` methods. Along with `employee.dat`, you'll discover the following output when you run this application:

```

John Doe
36

```

There's no guarantee that the same class will exist when a serialized object is deserialized (perhaps an instance field has been deleted). During deserialization, this mechanism causes `readObject()` to throw `java.io.InvalidClassException`—an indirect subclass of the `IOException` class—when it detects a difference between the deserialized object and its class.

Every serialized object has an identifier. The deserialization mechanism compares the identifier of the object being deserialized with the serialized identifier of its class (all serializable classes are automatically given unique identifiers unless they explicitly specify their own identifiers) and causes `InvalidClassException` to be thrown when it detects a mismatch.

Perhaps you've added an instance field to a class, and you want the deserialization mechanism to set the instance field to a default value rather than have `readObject()` throw an `InvalidClassException` instance. (The next time you serialize the object, the new field's value will be written out.)

You can avoid the thrown `InvalidClassException` instance by adding a static `final long serialVersionUID = long integer value;` declaration to the class. The *long integer value* must be unique and is known as a *stream unique identifier (SUID)*.

During deserialization, the virtual machine will compare the deserialized object's SUID to its class's SUID. If they match, `readObject()` will not throw `InvalidClassException` when it encounters a *compatible class change* (such as adding an instance field). However, it will still throw this exception when it encounters an *incompatible class change* (such as changing an instance field's name or type).

**Note** Whenever you change a class in some fashion, you must calculate a new SUID and assign it to `serialVersionUID`.

The JDK provides a `serialver` tool for calculating the SUID. For example, to generate an SUID for Listing 11-18's `Employee` class, change to the directory containing `Employee.class` and execute the following command:

```
serialver Employee
```

In response, `serialver` generates the following output, which you paste (except for `Employee:`) into `Employee.java`:

```
Employee:    static final long serialVersionUID = 1517331364702470316L;
```

The Windows version of `serialver` also provides a graphical user interface that you might find more convenient to use. To access this interface, specify the following command line:

```
serialver -show
```

When the `serialver` window appears, enter **Employee** into the Full Class Name text field and click the Show button, as demonstrated in Figure 11-6.

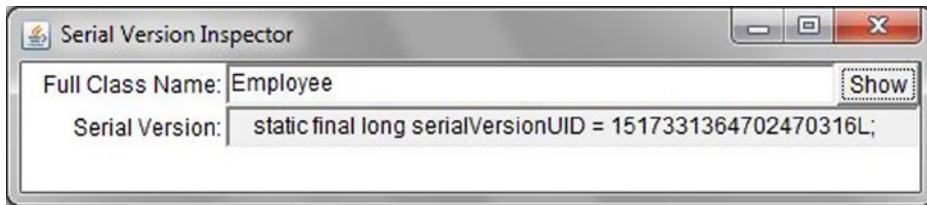

**Figure 11-6.** The `serialver` user interface reveals `Employee`'s SUID

## Custom Serialization and Deserialization

My previous discussion focused on default serialization and deserialization (with the exception of marking an instance field `transient` to prevent it from being included during serialization). However, situations arise where you need to customize these tasks.

For example, suppose you want to serialize instances of a class that doesn't implement `Serializable`. As a workaround, you subclass this other class, have the subclass implement `Serializable`, and forward subclass constructor calls to the superclass.

Although this workaround lets you serialize subclass objects, you cannot deserialize these serialized objects when the superclass doesn't declare a noargument constructor, which is required by the deserialization mechanism. Listing 11-20 demonstrates this problem.

**Listing 11-20.** *Problematic Deserialization*

```
import java.io.FileInputStream;
import java.io.FileOutputStream;
import java.io.IOException;
import java.io.ObjectInputStream;
```

```
import java.io.ObjectOutputStream;
import java.io.Serializable;

class Employee
{
    private String name;

    Employee(String name)
    {
        this.name = name;
    }

    @Override
    public String toString()
    {
        return name;
    }
}

class SerEmployee extends Employee implements Serializable
{
    SerEmployee(String name)
    {
        super(name);
    }
}

public class SerializationDemo
{
    public static void main(String[] args)
    {
        ObjectOutputStream oos = null;
        ObjectInputStream ois = null;
        try
        {
            oos = new ObjectOutputStream(new FileOutputStream("employee.dat"));
            SerEmployee se = new SerEmployee("John Doe");
            System.out.println(se);
            oos.writeObject(se);
            oos.close();
            oos = null;
            System.out.println("se object written to file");
            ois = new ObjectInputStream(new FileInputStream("employee.dat"));
            se = (SerEmployee) ois.readObject();
            System.out.println("se object read from file");
            System.out.println(se);
        }
        catch (ClassNotFoundException cnfe)
        {
            cnfe.printStackTrace();
        }
    }
}
```

```

catch (IOException ioe)
{
    ioe.printStackTrace();
}
finally
{
    if (oos != null)
        try
        {
            oos.close();
        }
        catch (IOException ioe)
        {
            assert false; // shouldn't happen in this context
        }
    if (ois != null)
        try
        {
            ois.close();
        }
        catch (IOException ioe)
        {
            assert false; // shouldn't happen in this context
        }
    }
}
}
}
}

```

Listing 11-20's `main()` method instantiates `SerEmployee` with an employee name. This class's `SerEmployee(String)` constructor passes this argument to its `Employee` counterpart.

`main()` next calls `Employee`'s `toString()` method indirectly via `System.out.println()` to obtain this name, which is then output.

Continuing, `main()` serializes the `SerEmployee` instance to an `employee.dat` file via `writeObject()`. It then attempts to deserialize this object via `readObject()`, and this is where the trouble occurs, as revealed by the following output:

```

John Doe
se object written to file
java.io.InvalidClassException: SerEmployee; no valid constructor
    at java.io.ObjectStreamClass$ExceptionInfo.newInvalidClassException(Unknown Source)
    at java.io.ObjectStreamClass.checkDeserialize(Unknown Source)
    at java.io.ObjectInputStream.readOrdinaryObject(Unknown Source)
    at java.io.ObjectInputStream.readObject0(Unknown Source)
    at java.io.ObjectInputStream.readObject(Unknown Source)
    at SerializationDemo.main(SerializationDemo.java:48)

```

This output reveals a thrown instance of the `InvalidClassException` class. This exception object was thrown during deserialization because `Employee` doesn't possess a noargument constructor.

You can overcome this problem by taking advantage of the wrapper class pattern that I presented in Chapter 4. Furthermore, you declare a pair of private methods in the subclass that the serialization and deserialization mechanisms look for and call.

Normally, the serialization mechanism writes out a class's instance fields to the underlying output stream. However, you can prevent this from happening by declaring a private void `writeObject(ObjectOutputStream oos)` method in that class.

When the serialization mechanism discovers this method, it calls the method instead of automatically outputting instance field values. The only values that are output are those explicitly output via the method.

Conversely, the deserialization mechanism assigns values to a class's instance fields that it reads from the underlying input stream. However, you can prevent this from happening by declaring a private void `readObject(ObjectInputStream ois)` method.

When the deserialization mechanism discovers this method, it calls the method instead of automatically assigning values to instance fields. The only values that are assigned to instance fields are those explicitly assigned via the method.

Because `SerEmployee` doesn't introduce any fields, and because `Employee` doesn't offer access to its internal fields (assume you don't have the source code for this class), what would a serialized `SerEmployee` object include?

Although you cannot serialize `Employee`'s internal state, you can serialize the argument(s) passed to its constructors, such as the employee name.

Listing 11-21 reveals the refactored `SerEmployee` and `SerializationDemo` classes.

*Listing 11-21. Solving Problematic Deserialization*

```
import java.io.FileInputStream;
import java.io.FileOutputStream;
import java.io.IOException;
import java.io.ObjectInputStream;
import java.io.ObjectOutputStream;
import java.io.Serializable;
```

```
class Employee
{
    private String name;

    Employee(String name)
    {
        this.name = name;
    }

    @Override
    public String toString()
    {
        return name;
    }
}
```

```
class SerEmployee implements Serializable
{
    private Employee emp;
    private String name;

    SerEmployee(String name)
    {
        this.name = name;
        emp = new Employee(name);
    }

    private void writeObject(ObjectOutputStream oos) throws IOException
    {
        oos.writeUTF(name);
    }

    private void readObject(ObjectInputStream ois)
        throws ClassNotFoundException, IOException
    {
        name = ois.readUTF();
        emp = new Employee(name);
    }

    @Override
    public String toString()
    {
        return name;
    }
}

public class SerializationDemo
{
    public static void main(String[] args)
    {
        ObjectOutputStream oos = null;
        ObjectInputStream ois = null;
        try
        {
            oos = new ObjectOutputStream(new FileOutputStream("employee.dat"));
            SerEmployee se = new SerEmployee("John Doe");
            System.out.println(se);
            oos.writeObject(se);
            oos.close();
            oos = null;
            System.out.println("se object written to file");
            ois = new ObjectInputStream(new FileInputStream("employee.dat"));
            se = (SerEmployee) ois.readObject();
            System.out.println("se object read from file");
            System.out.println(se);
        }
        catch (ClassNotFoundException cnfe)
        {
            cnfe.printStackTrace();
        }
    }
}
```

```

    catch (IOException ioe)
    {
        ioe.printStackTrace();
    }
    finally
    {
        if (oos != null)
            try
            {
                oos.close();
            }
            catch (IOException ioe)
            {
                assert false; // shouldn't happen in this context
            }
        if (ois != null)
            try
            {
                ois.close();
            }
            catch (IOException ioe)
            {
                assert false; // shouldn't happen in this context
            }
        }
    }
}
}
}

```

`SerEmployee`'s `writeObject()` and `readObject()` methods rely on `DataOutput` and `DataInput` methods: they don't need to call `ObjectOutputStream`'s `writeObject()` method and `ObjectInputStream`'s `readObject()` method to perform their tasks.

When you run this application, it generates the following output:

```

John Doe
se object written to file
se object read from file
John Doe

```

The `writeObject()` and `readObject()` methods can be used to serialize/deserialize data items beyond the normal state (non-transient instance fields), for example, serializing/deserializing the contents of a static field.

However, before serializing or deserializing the additional data items, you must tell the serialization and deserialization mechanisms to serialize or deserialize the object's normal state. The following methods help you accomplish this task:

- `ObjectOutputStream`'s `defaultWriteObject()` method outputs the object's normal state. Your `writeObject()` method first calls this method to output that state and then outputs additional data items via `ObjectOutputStream` methods such as `writeUTF()`.

- `ObjectInputStream`'s `defaultReadObject()` method inputs the object's normal state. Your `readObject()` method first calls this method to input that state and then inputs additional data items via `ObjectInputStream` methods such as `readUTF()`.

## Externalization

Along with default serialization/deserialization and custom serialization/deserialization, Java supports externalization. Unlike default/custom serialization/deserialization, *externalization* offers complete control over the serialization and deserialization tasks.

**Note** Externalization helps you improve the performance of the reflection-based serialization and deserialization mechanisms by giving you complete control over what fields are serialized and deserialized.

Java supports externalization via `java.io.Externalizable`. This interface declares the following pair of public methods:

- `void writeExternal(ObjectOutput out)` saves the calling object's contents by calling various methods on the `out` object. This method throws `IOException` when an I/O error occurs. (`java.io.ObjectOutput` is a subinterface of `DataOutput` and is implemented by `ObjectOutputStream`.)
- `void readExternal(ObjectInput in)` restores the calling object's contents by calling various methods on the `in` object. This method throws `IOException` when an I/O error occurs and `ClassNotFoundException` when the class of the object being restored cannot be found. (`java.io.ObjectInput` is a subinterface of `DataInput` and is implemented by `ObjectInputStream`.)

If a class implements `Externalizable`, its `writeExternal()` method is responsible for saving all field values that are to be saved. Also, its `readExternal()` method is responsible for restoring all saved field values and in the order they were saved.

Listing 11-22 presents a refactored version of Listing 11-18's `Employee` class to show you how to take advantage of externalization.

### *Listing 11-22. Refactoring Listing 11-18's Employee Class to Support Externalization*

```
import java.io.Externalizable;
import java.io.IOException;
import java.io.ObjectInput;
import java.io.ObjectOutput;

public class Employee implements Externalizable
{
    private String name;
    private int age;
```



```

public Employee()
{
    System.out.println("Employee() called");
}

public Employee(String name, int age)
{
    this.name = name;
    this.age = age;
}

public String getName() { return name; }

public int getAge() { return age; }

@Override
public void writeExternal(ObjectOutput out) throws IOException
{
    System.out.println("writeExternal() called");
    out.writeUTF(name);
    out.writeInt(age);
}

@Override
public void readExternal(ObjectInput in)
    throws IOException, ClassNotFoundException
{
    System.out.println("readExternal() called");
    name = in.readUTF();
    age = in.readInt();
}
}

```

Employee declares a public `Employee()` constructor because each class that participates in externalization must declare a public noargument constructor. The deserialization mechanism calls this constructor to instantiate the object.

**Caution** The deserialization mechanism throws `InvalidClassException` with a “no valid constructor” message when it doesn’t detect a public noargument constructor.

Initiate externalization by instantiating `ObjectOutputStream` and calling its `writeObject(Object)` method, or by instantiating `ObjectInputStream` and calling its `readObject()` method.

**Note** When passing an object whose class (directly/indirectly) implements `Externalizable` to `writeObject()`, the `writeObject()`-initiated serialization mechanism writes only the identity of the object’s class to the object output stream.

Suppose you compiled Listing 11-19's `SerializationDemo.java` source code and Listing 11-22's `Employee.java` source code in the same directory. Now suppose you executed `java SerializationDemo`. In response, you would observe the following output:

```
writeExternal() called
Employee() called
readExternal() called
John Doe
36
```

Before serializing an object, the serialization mechanism checks the object's class to see if it implements `Externalizable`. If so, the mechanism calls `writeExternal()`. Otherwise, it looks for a private `writeObject(ObjectOutputStream)` method and calls this method when present. When this method isn't present, this mechanism performs default serialization, which includes only nontransient instance fields.

Before deserializing an object, the deserialization mechanism checks the object's class to see if it implements `Externalizable`. If so, the mechanism attempts to instantiate the class via the public noargument constructor. Assuming success, it calls `readExternal()`.

When the object's class doesn't implement `Externalizable`, the deserialization mechanism looks for a private `readObject(ObjectInputStream)` method. When this method isn't present, this mechanism performs default deserialization, which includes only non-transient instance fields.

## PrintStream

Of all the stream classes, `PrintStream` is an oddball: it should have been named `PrintOutputStream` for consistency with the naming convention. This filter output stream class writes string representations of input data items to the underlying output stream.

**Note** `PrintStream` uses the default character encoding to convert a string's characters to bytes. (I'll discuss character encodings when I introduce you to writers and readers in the next section.) Because `PrintStream` doesn't support different character encodings, you should use the equivalent `PrintWriter` class instead of `PrintStream`. However, you need to know about `PrintStream` because of Standard I/O (see Chapter 1 for an introduction to this topic).

`PrintStream` instances are print streams whose various `print()` and `println()` methods print string representations of integers, floating-point values, and other data items to the underlying output stream. Unlike the `print()` methods, `println()` methods append a line terminator to their output.

**Note** The line terminator (also known as line separator) isn't necessarily the newline (also commonly referred to as line feed). Instead, to promote portability, the line separator is the sequence of characters defined by system property `line.separator`. On Windows platforms, `System.getProperty("line.separator")` returns the actual carriage return code (13), which is symbolically represented by `\r`, followed by the actual newline/line feed code (10), which is symbolically represented by `\n`. In contrast, `System.getProperty("line.separator")` returns only the actual newline/line feed code on Unix and Linux platforms.

The `println()` methods call their corresponding `print()` methods followed by the equivalent of the `void println()` method, which eventually results in `line.separator`'s value being output. For example, `void println(int x)` outputs `x`'s string representation and calls this method to output the line separator.

**Caution** Never hard-code the `\n` escape sequence in a string literal that you are going to output via a `print()` or `println()` method. Doing so isn't portable. For example, when Java executes `System.out.print("first line\n");` followed by `System.out.println("second line");`, you will see `first line` on one line followed by `second line` on a subsequent line when this output is viewed at the Windows command line. In contrast, you'll see `first linesecond line` when this output is viewed in the Windows Notepad application (which requires a carriage return/line feed sequence to terminate lines). When you need to output a blank line, the easiest way to do this is to call `System.out.println();`, which is why you find this method call used elsewhere in my book. I confess that I don't always follow my own advice, so you might find instances of `\n` in literal strings being passed to `System.out.print()` or `System.out.println()` elsewhere in this book.

`PrintStream` offers three other features that you'll find useful:

- Unlike other output streams, a print stream never rethrows an `IOException` instance thrown from the underlying output stream. Instead, exceptional situations set an internal flag that can be tested by calling `PrintStream`'s `boolean checkError()` method, which returns `true` to indicate a problem.
- `PrintStream` objects can be created to automatically flush their output to the underlying output stream. In other words, the `flush()` method is automatically called after a byte array is written, one of the `println()` methods is called, or a newline is written.
- `PrintStream` declares a `PrintStream format(String format, Object... args)` method for achieving formatted output. Behind the scene, this method works with the `Formatter` class that I introduce in Chapter 13. `PrintStream` also declares a `printf(String format, Object... args)` convenience method that delegates to the `format()` method. For example, invoking `printf()` via `out.printf(format, args)` is identical to invoking `out.format(format, args)`.

## Standard I/O Revisited

In Chapter 1, I introduced you to Standard I/O. I stated that you input data items from the standard input stream by making `System.in.read()` method calls, that you output data items to the standard output stream by making `System.out.print()` and `System.out.println()` method calls, and that you output data items to the standard error stream by making `System.err.print()` and `System.err.println()` method calls. Finally, I discussed I/O redirection.

`System.in`, `System.out`, and `System.err` are formally described by the following class fields in the `System` class:

- `public static final InputStream in`
- `public static final PrintStream out`
- `public static final PrintStream err`

These fields contain references to `InputStream` and `PrintStream` objects that represent the standard input, standard output, and standard error streams.

When you invoke `System.in.read()`, the input is originating from the source identified by the `InputStream` instance assigned to `in`. Similarly, when you invoke `System.out.print()` or `System.err.println()`, the output is being sent to the destination identified by the `PrintStream` instance assigned to `out` or `err`, respectively.

**Tip** On an Android device, you can view content sent to standard output and standard error by first executing `adb logcat` at the command line. `adb` is one of the tools included in the Android SDK.

Java initializes `in` to refer to the keyboard or a file when the standard input stream is redirected to the file. Similarly, Java initializes `out/err` to refer to the screen or a file when the standard output/error stream is redirected to the file. You can programmatically specify the input source, output destination, and error destination by calling the following `System` class methods:

- `void setIn(InputStream in)`
- `void setOut(PrintStream out)`
- `void setErr(PrintStream err)`

Listing 11-23 presents an application that shows you how to use these methods to programmatically redirect the standard input, standard output, and standard error destinations.

*Listing 11-23. Programmatically Specifying the Standard Input Source and Standard Output/Error Destinations*

```
import java.io.FileInputStream;
import java.io.IOException;
import java.io.PrintStream;

public class RedirectIO
{
    public static void main(String[] args) throws IOException
    {
```

```

if (args.length != 3)
{
    System.err.println("usage: java RedirectIO stdinfile stdoutfile stderrfile");
    return;
}

System.setIn(new FileInputStream(args[0]));
System.setOut(new PrintStream(args[1]));
System.setErr(new PrintStream(args[2]));

int ch;
while ((ch = System.in.read()) != -1)
    System.out.print((char) ch);

System.err.println("Redirected error output");
}
}

```

Listing 11-23 presents a `RedirectIO` application that lets you specify (via command-line arguments) the name of a file from which `System.in.read()` obtains its content as well as the names of files to which `System.out.print()` and `System.err.println()` send their content. It then proceeds to copy standard input to standard output and then demonstrates outputting content to standard error.

Next, new `FileInputStream(args[0])` provides access to the input sequence of bytes that is stored in the file identified by `args[0]`. Similarly, new `PrintStream(args[1])` provides access to the file identified by `args[1]`, which will store the output sequence of bytes, and new `PrintStream(args[2])` provides access to the file identified by `args[2]`, which will store the error sequence of bytes.

Compile Listing 11-23 (`javac RedirectIO.java`). Then execute the following command line:

```
java RedirectIO RedirectIO.java out.txt err.txt
```

This command line produces no visual output on the screen. Instead, it copies the contents of `RedirectIO.java` to `out.txt`. It also stores `Redirected error output` in `err.txt`.

## Working with Writers and Readers

Java's stream classes are good for streaming sequences of bytes, but they're not good for streaming sequences of characters because bytes and characters are two different things: a byte represents an 8-bit data item and a character represents a 16-bit data item. Also, Java's `char` and `String` types naturally handle characters instead of bytes.

More importantly, byte streams have no knowledge of *character sets* (sets of mappings between integer values, known as *code points*, and symbols, such as Unicode) and their *character encodings* (mappings between the members of a character set and sequences of bytes that encode these characters for efficiency, such as UTF-8).

If you need to stream characters, you should take advantage of Java's writer and reader classes, which were designed to support character I/O (they work with `char` instead of `byte`). Furthermore, the writer and reader classes take character encodings into account.

## A BRIEF HISTORY OF CHARACTER SETS AND CHARACTER ENCODINGS

Early computers and programming languages were created mainly by English-speaking programmers in countries where English was the native language. They developed a standard mapping between code points 0 through 127, and the 128 commonly used characters in the English language (such as A–Z). The resulting character set/encoding was named *American Standard Code for Information Interchange (ASCII)*.

The problem with ASCII is that it's inadequate for most non-English languages. For example, ASCII doesn't support diacritical marks such as the cedilla used in French. Because a byte can represent a maximum of 256 different characters, developers around the world started creating different character sets/encodings that encoded the 128 ASCII characters, but also encoded extra characters to meet the needs of languages such as French, Greek, or Russian. Over the years, many legacy (and still important) data files have been created whose bytes represent characters defined by specific character sets/encodings.

The International Organization for Standardization (ISO) and the International Electrotechnical Commission (IEC) have worked to standardize these 8-bit character sets/encodings under a joint umbrella standard called ISO/IEC 8859. The result is a series of substandards named ISO/IEC 8859-1, ISO/IEC 8859-2, and so on. For example, ISO/IEC 8859-1 (also known as Latin-1) defines a character set/encoding that consists of ASCII plus the characters covering most Western European countries. Also, ISO/IEC 8859-2 (also known as Latin-2) defines a similar character set/encoding covering Central and Eastern European countries.

Despite ISO's/IEC's best efforts, a plethora of character sets/encodings is still inadequate. For example, most character sets/encodings only allow you to create documents in a combination of English and one other language (or a small number of other languages). You cannot, for example, use an ISO/IEC character set/encoding to create a document using a combination of English, French, Turkish, Russian, and Greek characters.

This and other problems are being addressed by an international effort that has created and is continuing to develop *Unicode*, a single universal character set. Because Unicode characters are bigger than ISO/IEC characters, Unicode uses one of several variable-length encoding schemes known as *Unicode Transformation Format (UTF)* to encode Unicode characters for efficiency. For example, UTF-8 encodes every character in the Unicode character set in 1 to 4 bytes (and is backward compatible with ASCII).

The terms *character set* and *character encoding* are often used interchangeably. They mean the same thing in the context of ISO/IEC character sets in which a code point is the encoding. However, these terms are different in the context of Unicode in which Unicode is the character set and UTF-8 is one of several possible character encodings for Unicode characters.

---

## Writer and Reader Classes Overview

The `java.io` package provides several writer and reader classes that are descendants of the abstract `Writer` and `Reader` classes. Figure 11-7 reveals the hierarchy of writer classes.

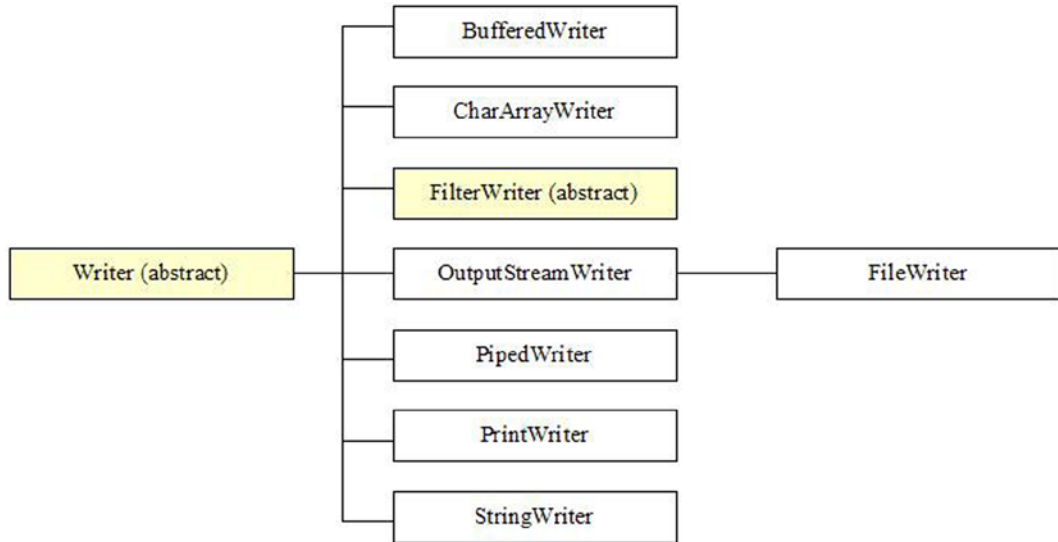

**Figure 11-7.** Unlike `FilterOutputStream`, `FilterWriter` is abstract

Figure 11-8 reveals the hierarchy of reader classes.

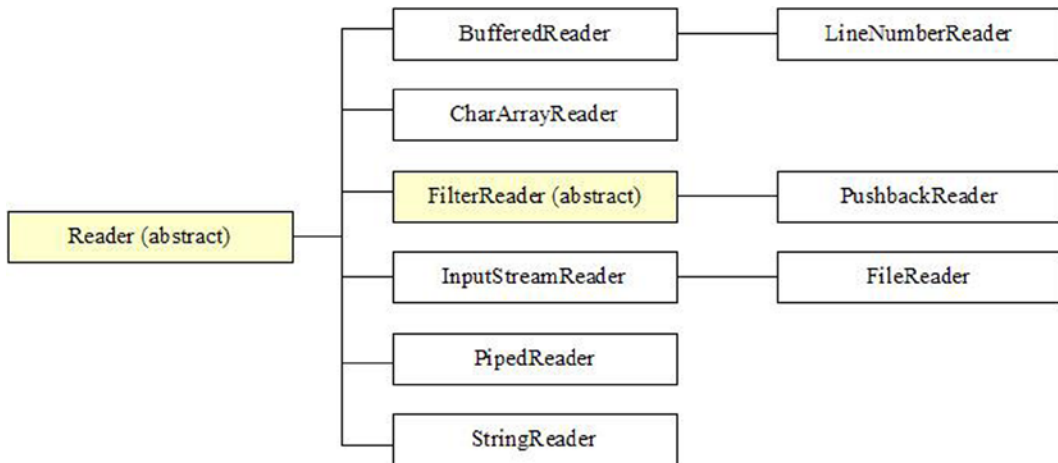

**Figure 11-8.** Unlike `FilterInputStream`, `FilterReader` is abstract

Although the writer and reader class hierarchies are similar to their output stream and input stream counterparts, there are differences. For example, `FilterWriter` and `FilterReader` are abstract, whereas their `FilterOutputStream` and `FilterInputStream` equivalents are not abstract. Also, `BufferedWriter` and `BufferedReader` don't extend `FilterWriter` and `FilterReader`, whereas `BufferedOutputStream` and `BufferedInputStream` extend `FilterOutputStream` and `FilterInputStream`.

The output stream and input stream classes were introduced in Java 1.0. After their release, design issues emerged. For example, `FilterOutputStream` and `FilterInputStream` should have been abstract. However, it was too late to make these changes because the classes were already being used; making these changes would have resulted in broken code. The designers of Java 1.1's writer and reader classes took the time to correct these mistakes.

**Note** Regarding `BufferedWriter` and `BufferedReader` directly subclassing `Writer` and `Reader` instead of `FilterWriter` and `FilterReader`, I believe that this change has to do with performance. Calls to `BufferedOutputStream`'s `write()` methods and `BufferedInputStream`'s `read()` methods result in calls to `FilterOutputStream`'s `write()` methods and `FilterInputStream`'s `read()` methods. Because a file I/O activity such as copying one file to another can involve many `write()/read()` method calls, you want the best performance possible. By not subclassing `FilterWriter` and `FilterReader`, `BufferedWriter` and `BufferedReader` achieve better performance.

For brevity, I focus only on the `Writer`, `Reader`, `OutputStreamWriter`, `OutputStreamReader`, `FileWriter`, and `FileReader` classes in this chapter.

## Writer and Reader

Java provides the `Writer` and `Reader` classes for performing character I/O. `Writer` is the superclass of all writer subclasses. The following list identifies differences between `Writer` and `OutputStream`:

- `Writer` declares several `append()` methods for appending characters to this writer. These methods exist because `Writer` implements the `java.lang.Appendable` interface, which is used in partnership with the `Formatter` class (discussed in Chapter 13) to output formatted strings.
- `Writer` declares additional `write()` methods, including a convenient `void write(String str)` method for writing a `String` object's characters to this writer.

`Reader` is the superclass of all reader subclasses. The following list identifies differences between `Reader` and `InputStream`:

- `Reader` declares `read(char[])` and `read(char[], int, int)` methods instead of `read(byte[])` and `read(byte[], int, int)` methods.
- `Reader` doesn't declare an `available()` method.
- `Reader` declares a `boolean ready()` method that returns `true` when the next `read()` call is guaranteed not to block for input.
- `Reader` declares an `int read(CharBuffer target)` method for reading characters from a character buffer. (I discuss `CharBuffer` in Chapter 13.)



## OutputStreamWriter and InputStreamReader

The concrete `OutputStreamWriter` class (a `Writer` subclass) is a bridge between an incoming sequence of characters and an outgoing stream of bytes. Characters written to this writer are encoded into bytes according to the default or specified character encoding.

**Note** The default character encoding is accessible via the `file.encoding` system property.

Each call to one of `OutputStreamWriter`'s `write()` methods causes an encoder to be called on the given character(s). The resulting bytes are accumulated in a buffer before being written to the underlying output stream. The characters passed to the `write()` methods are not buffered.

`OutputStreamWriter` declares four constructors, including the following pair:

- `OutputStreamWriter(OutputStream out)` creates a bridge between an incoming sequence of characters (passed to `OutputStreamWriter` via its `append()` and `write()` methods) and underlying output stream `out`. The default character encoding is used to encode characters into bytes.
- `OutputStreamWriter(OutputStream out, String charsetName)` creates a bridge between an incoming sequence of characters (passed to `OutputStreamWriter` via its `append()` and `write()` methods) and underlying output stream `out`. `charsetName` identifies the character encoding used to encode characters into bytes. This constructor throws `java.io.UnsupportedEncodingException` when the named character encoding isn't supported.

**Note** `OutputStreamWriter` depends on the abstract `java.nio.charset.Charset` and `java.nio.charset.CharsetEncoder` classes (see Chapter 13) to perform character encoding.

The following example uses the second constructor to create a bridge to an underlying file output stream so that Polish text can be written to an ISO/IEC 8859-2-encoded file:

```
FileOutputStream fos = new FileOutputStream("polish.txt");
OutputStreamWriter osw = new OutputStreamWriter(fos, "8859_2");
char ch = '\u0323'; // Accented N.
osw.write(ch);
```

The concrete `InputStreamReader` class (a `Reader` subclass) is a bridge between an incoming stream of bytes and an outgoing sequence of characters. Characters read from this reader are decoded from bytes according to the default or specified character encoding.

Each call to one of `InputStreamReader`'s `read()` methods may cause one or more bytes to be read from the underlying input stream. To enable the efficient conversion of bytes to characters, more bytes may be read ahead from the underlying stream than are necessary to satisfy the current read operation.

`InputStreamReader` declares four constructors, including the following pair:

- `InputStreamReader(InputStream in)` creates a bridge between underlying input stream `in` and an outgoing sequence of characters (returned from `InputStreamReader` via its `read()` methods). The default character encoding is used to decode bytes into characters.
- `InputStreamReader(InputStream in, String charsetName)` creates a bridge between underlying input stream `in` and an outgoing sequence of characters (returned from `InputStreamReader` via its `read()` methods). `charsetName` identifies the character encoding used to decode bytes into characters. This constructor throws `UnsupportedEncodingException` when the named character encoding is not supported.

**Note** `InputStreamReader` depends on the abstract `Charset` and `java.nio.charset` `.CharsetDecoder` classes (see Chapter 13) to perform character decoding.

The following example uses the second constructor to create a bridge to an underlying file input stream so that Polish text can be read from an ISO/IEC 8859-2-encoded file:

```
FileInputStream fis = new FileInputStream("polish.txt");
InputStreamReader isr = new InputStreamReader(fis, "8859_2");
char ch = isr.read(ch);
```

**Note** `OutputStreamWriter` and `InputStreamReader` declare a `String getEncoding()` method that returns the name of the character encoding in use. If the encoding has a historical name, that name is returned; otherwise, the encoding's canonical name is returned.

## FileWriter and FileReader

`FileWriter` is a convenience class for writing characters to files. It subclasses `OutputStreamWriter`, and its constructors call `OutputStreamWriter(OutputStream)`. An instance of this class is equivalent to the following code fragment:

```
FileOutputStream fos = new FileOutputStream(pathname);
OutputStreamWriter osw;
osw = new OutputStreamWriter(fos, System.getProperty("file.encoding"));
```

In Chapter 5, I presented a logging library with a `File` class that didn't incorporate file-writing code. Listing 11-24 addresses this situation by presenting a revised `File` class that uses `FileWriter` to log messages to a file.

*Listing 11-24. Logging Messages to an Actual File*

```
package logging;

import java.io.FileWriter;
import java.io.IOException;

class File implements Logger
{
    private final static String LINE_SEPARATOR = System.getProperty("line.separator");

    private String dstName;
    private FileWriter fw;

    File(String dstName)
    {
        this.dstName = dstName;
    }

    public boolean connect()
    {
        if (dstName == null)
            return false;
        try
        {
            fw = new FileWriter(dstName);
        }
        catch (IOException ioe)
        {
            return false;
        }
        return true;
    }

    public boolean disconnect()
    {
        if (fw == null)
            return false;
        try
        {
            fw.close();
        }
        catch (IOException ioe)
        {
            return false;
        }
        return true;
    }

    public boolean log(String msg)
    {
        if (fw == null)
```

```

        return false;
    try
    {
        fw.write(msg + LINE_SEPARATOR);
    }
    catch (IOException ioe)
    {
        return false;
    }
    return true;
}
}

```

Listing 11-24 refactors Chapter 5's `File` class to support `FileWriter` by making changes to each of the `connect()`, `disconnect()`, and `log()` methods:

- `connect()` attempts to instantiate `FileWriter`, whose instance is saved in `fw` on success; otherwise, `fw` continues to store its default null reference.
- `disconnect()` attempts to close the file by calling `FileWriter`'s `close()` method, but only when `fw` doesn't contain its default null reference.
- `log()` attempts to write its `String` argument to the file by calling `FileWriter`'s `void write(String str)` method, but only when `fw` doesn't contain its default null reference.

`connect()`'s catch block specifies `IOException` instead of `FileNotFoundException` because `FileWriter`'s constructors throw `IOException` when they cannot connect to existing normal files; `FileOutputStream`'s constructors throw `FileNotFoundException`.

`log()`'s `write(String)` method appends the `line.separator` value (which I assigned to a constant for convenience) to the string being output instead of appending `\n`, which would violate portability.

`FileReader` is a convenience class for reading characters from files. It subclasses `InputStreamReader`, and its constructors call `InputStreamReader(InputStream)`. An instance of this class is equivalent to the following code fragment:

```

FileInputStream fis = new FileInputStream(pathname);
InputStreamReader isr;
isr = new InputStreamReader(fis, System.getProperty("file.encoding"));

```

It's often necessary to search text files for occurrences of specific strings. Although regular expressions (discussed in Chapter 13) are ideal for this task, I have yet to discuss them. As a result, Listing 11-25 presents the more verbose alternative to regular expressions.

**Listing 11-25. Finding All Files That Contain Content Matching a Search String**

```

import java.io.BufferedReader;
import java.io.File;
import java.io.FileReader;
import java.io.IOException;

```

```
public class FindAll
{
    public static void main(String[] args)
    {
        if (args.length != 2)
        {
            System.err.println("usage: java FindAll start search-string");
            return;
        }
        if (!findAll(new File(args[0]), args[1]))
            System.err.println("not a directory");
    }

    static boolean findAll(File file, String srchText)
    {
        File[] files = file.listFiles();
        if (files == null)
            return false;
        for (int i = 0; i < files.length; i++)
            if (files[i].isDirectory())
                findAll(files[i], srchText);
            else
                if (find(files[i].getPath(), srchText))
                    System.out.println(files[i].getPath());
        return true;
    }

    static boolean find(String filename, String srchText)
    {
        BufferedReader br = null;
        try
        {
            br = new BufferedReader(new FileReader(filename));
            int ch;
            outer_loop:
            do
            {
                if ((ch = br.read()) == -1)
                    return false;
                if (ch == srchText.charAt(0))
                {
                    for (int i = 1; i < srchText.length(); i++)
                    {
                        if ((ch = br.read()) == -1)
                            return false;
                        if (ch != srchText.charAt(i))
                            continue outer_loop;
                    }
                }
                return true;
            }
        }
    }
}
```

```

        while (true);
    }
    catch (IOException ioe)
    {
        System.err.println("I/O error: " + ioe.getMessage());
    }
    finally
    {
        if (br != null)
            try
            {
                br.close();
            }
            catch (IOException ioe)
            {
                assert false; // shouldn't happen in this context
            }
        }
    }
    return false;
}
}

```

Listing 11-25's FindAll class declares main(), findAll(), and find() class methods.

main() validates the number of command-line arguments, which must be two. The first argument identifies the starting location within the filesystem for the search, and is used to construct a File object. The second argument specifies search text. main() then passes the File object and the search text to findAll() to perform a search for all files containing this text.

The recursive findAll() method first invokes listFiles() on the File object passed to this method to obtain the names of all files in the current directory. If listFiles() returns null, meaning that the File object doesn't refer to an existing directory, findAll() returns false and a suitable error message is output.

For each name in the returned list, findAll() either recursively invokes itself when the name represents a directory, or invokes the find() method to search the file for the text; the file's pathname string is output when the file contains this text.

The find() method first opens the file identified by its first argument via the FileReader class and then passes the FileReader instance to a BufferedReader instance to improve file-reading performance. It then enters a loop that continues to read characters from the file until the end of the file is reached.

If the currently read character matches the first character in the search text, an inner loop is entered to read subsequent characters from the file and compare them with subsequent characters in the search text. When all characters match, find() returns true. Otherwise, the labeled continue statement is used to skip the remaining iterations of the inner loop and transfer execution to the labeled outer loop. After the last character has been read and there's still no match, find() returns false.

Now that you know how FindAll works, you'll probably want to try it out. The following examples show you how I might use this application on my Windows 7 platform:

```
java FindAll \prj\dev RenderScript
```

This example searches the `\prj\dev` directory on my default drive (C:) for all files that contain the word `RenderScript` (case is significant) and generates the following output:

```
\prj\dev\ar2\appb\ar\1-4302-4614-5_Friesen_AppB_Android_Tools_Overview.doc
\prj\dev\ar2\appb\ce\1-4302-4614-5_Friesen_AppB_Android_Tools_Overview.doc
\prj\dev\ar2\ch08\1-4302-4614-5_Friesen_Ch08_Working_with_Android_NDK_and_RenderScript.doc
\prj\dev\ar2\ch08\ar\1-4302-4614-5_Friesen_Ch08_Working_with_Android_NDK_and_RenderScript.doc
\prj\dev\ar2\ch08\ce\1-4302-4614-5_Friesen_Ch08_Working_with_Android_NDK_and_RenderScript.doc
\prj\dev\ar2\ch08\code\GrayScale\GrayScale.java
\prj\dev\ar2\ch08\code\WavyImage\WavyImage.java
\prj\dev\ar2\code\ch08\GrayScale\GrayScale.java
\prj\dev\ar2\code\ch08\WavyImage\WavyImage.java
\prj\dev\ar2\extra\ndkrs.txt
\prj\dev\EmbossImage\src\ca\tutortutor\embossimage\EmbossImage.java
\prj\dev\GrayScale\src\ca\tutortutor\grayscale\GrayScale.java
\prj\dev\WavyImage\src\ca\tutortutor\wavyimage\WavyImage.java
```

If I now specify `java FindAll \prj\dev "Jelly Bean"`, I observe the following abbreviated output:

```
\prj\dev\ar2\ch01\1-4302-4614-5_Friesen_Ch01_Getting_Started_with_Android.doc
\prj\dev\ar2\ch01\ar\1-4302-4614-5_Friesen_Ch01_Getting_Started_with_Android.doc
\prj\dev\ar2\ch01\ce\1-4302-4614-5_Friesen_Ch01_Getting_Started_with_Android.doc
```

## EXERCISES

The following exercises are designed to test your understanding of Chapter 11's content.

1. What is the purpose of the `File` class?
2. What do instances of the `File` class contain?
3. What does `File`'s `listRoots()` method accomplish?
4. What is a path and what is a pathname?
5. What is the difference between an absolute pathname and a relative pathname?
6. How do you obtain the current user (also known as working) directory?
7. Define parent pathname.
8. `File`'s constructors normalize their pathname arguments. What does normalize mean?
9. How do you obtain the default name-separator character?
10. What is a canonical pathname?
11. What is the difference between `File`'s `getParent()` and `getName()` methods?
12. True or false: `File`'s `exists()` method only determines whether or not a file exists.
13. What is a normal file?
14. What does `File`'s `lastModified()` method return?

15. True or false: `File`'s `list()` method returns an array of `Strings` where each entry is a filename rather than a complete path.
16. What is the difference between the `FilenameFilter` and `FileFilter` interfaces?
17. True or false: `File`'s `createNewFile()` method doesn't check for file existence and create the file when it doesn't exist in a single operation that's atomic with respect to all other filesystem activities that might affect the file.
18. `File`'s `createTempFile(String, String)` method creates a temporary file in the default temporary directory. How can you locate this directory?
19. Temporary files should be removed when no longer needed after an application exits (to avoid cluttering the filesystem). How do you ensure that a temporary file is removed when the virtual machine ends normally (it doesn't crash and the power isn't lost)?
20. How would you accurately compare two `File` objects?
21. What is the purpose of the `RandomAccessFile` class?
22. What is the purpose of the "rwd" and "rws" mode arguments?
23. What is a file pointer?
24. True or false: When you call `RandomAccessFile`'s `seek(long)` method to set the file pointer's value, and when this value is greater than the length of the file, the file's length changes.
25. Define flat file database.
26. What is a stream?
27. What is the purpose of `OutputStream`'s `flush()` method?
28. True or false: `OutputStream`'s `close()` method automatically flushes the output stream.
29. What is the purpose of `InputStream`'s `mark(int)` and `reset()` methods?
30. How would you access a copy of a `ByteArrayOutputStream` instance's internal byte array?
31. True or false: `FileOutputStream` and `FileInputStream` provide internal buffers to improve the performance of write and read operations.
32. Why would you use `PipedOutputStream` and `PipedInputStream`?
33. Define filter stream.
34. What does it mean for two streams to be chained together?
35. How do you improve the performance of a file output stream or a file input stream?
36. How do `DataOutputStream` and `DataInputStream` support `FileOutputStream` and `FileInputStream`?
37. What is object serialization and deserialization?
38. What three forms of serialization and deserialization does Java support?
39. What is the purpose of the `Serializable` interface?



40. What does the serialization mechanism do when it encounters an object whose class doesn't implement `Serializable`?
41. Identify the three stated reasons for Java not supporting unlimited serialization.
42. How do you initiate serialization? How do you initiate deserialization?
43. True or false: Class fields are automatically serialized.
44. What is the purpose of the `transient` reserved word?
45. What does the deserialization mechanism do when it attempts to deserialize an object whose class has changed?
46. How does the deserialization mechanism detect that a serialized object's class has changed?
47. How can you add an instance field to a class and avoid trouble when deserializing an object that was serialized before the instance field was added? What JDK tool can you use to help with this task?
48. How do you customize the default serialization and deserialization mechanisms without using externalization?
49. How do you tell the serialization and deserialization mechanisms to serialize or deserialize the object's normal state before serializing or deserializing additional data items?
50. How does externalization differ from default and custom serialization and deserialization?
51. How does a class indicate that it supports externalization?
52. True or false: During externalization, the deserialization mechanism throws `InvalidClassException` with a "no valid constructor" message when it doesn't detect a public noargument constructor.
53. What is the difference between `PrintStream`'s `print()` and `println()` methods?
54. What does `PrintStream`'s noargument void `println()` method accomplish?
55. Why are Java's stream classes not good at streaming characters?
56. What does Java provide as the preferred alternative to stream classes when it comes to character I/O?
57. True or false: `Reader` declares an `available()` method.
58. What is the purpose of the `OutputStreamWriter` class? What is the purpose of the `InputStreamReader` class?
59. How do you identify the default character encoding?
60. What is the purpose of the `FileWriter` class? What is the purpose of the `FileReader` class?
61. Create a Java application named `Touch` for setting a file's or directory's timestamp to the current time. This application has the following usage syntax: `java Touch pathname`.
62. Improve Listing 11-11's `Copy` application (performance wise) by using `BufferedInputStream` and `BufferedOutputStream`. `Copy` should read the bytes to be copied from the buffered input stream and write these bytes to the buffered output stream.

63. Create a Java application named `Split` for splitting a large file into a number of smaller `partx` files (where `x` starts at 0 and increments; for example, `part0`, `part1`, `part2`, and so on). Each `partx` file (except possibly the last `partx` file, which holds the remaining bytes) will have the same size. This application has the following usage syntax: `java Split pathname`. Furthermore, your implementation must use the `BufferedInputStream`, `BufferedOutputStream`, `File`, `FileInputStream`, and `FileOutputStream` classes.
  64. It's often convenient to read lines of text from standard input, and the `InputStreamReader` and `BufferedReader` classes make this task possible. Create a Java application named `CircleInfo` that, after obtaining a `BufferedReader` instance that is chained to standard input, presents a loop that prompts the user to enter a radius, parses the entered radius into a `double` value, and outputs a pair of messages that report the circle's circumference and area based on this radius.
- 

## Summary

Applications often input data for processing and output processing results. Data is input from a file or some other source and is output to a file or some other destination. Java supports I/O via the classic I/O APIs located in the `java.io` package.

File I/O activities often interact with a filesystem. Java offers access to the underlying platform's available filesystem(s) via its concrete `File` class. `File` instances contain the pathnames of files and directories that may or may not exist in their filesystems.

Files can be opened for random access in which a mixture of write and read operations can occur until the file is closed. Java supports this random access by providing the concrete `RandomAccessFile` class.

Java uses streams to perform I/O operations. A stream is an ordered sequence of bytes of arbitrary length. Bytes flow over an output stream from an application to a destination and flow over an input stream from a source to an application.

The `java.io` package provides several output stream and input stream classes that are descendents of the abstract `OutputStream` and `InputStream` classes. `BufferedOutputStream` and `FileInputStream` are examples.

Java's stream classes are good for streaming sequences of bytes but are not good for streaming sequences of characters because bytes and characters are two different things, and because byte streams have no knowledge of character sets and encodings.

If you need to stream characters, you should take advantage of Java's writer and reader classes, which were designed to support character I/O (they work with `char` instead of `byte`). Furthermore, the writer and reader classes take character encodings into account.

The `java.io` package provides several writer and reader classes that are descendents of the abstract `Writer` and `Reader` classes. `FileWriter` and `FileReader` are examples. These convenience classes are based on file output/input streams and `OutputStreamWriter/InputStreamReader`.

This chapter focused on I/O in the context of a filesystem. However, you can also perform I/O in the context of a network. Chapter 12 introduces you to several of Java's network-oriented APIs.

# Accessing Networks

Applications often need to access networks to acquire resources (such as images) or to communicate with remote executable entities (such as web services). A *network* is a group of interconnected *nodes* (computing devices such as tablets, and peripherals such as scanners or laser printers) that can be shared among the network's users.

**Note** An *intranet* is a network located within an organization and an *internet* is a network connecting organizations to each other. The *Internet* is the global network of networks.

Intranets and internets often use *TCP/IP* ([http://en.wikipedia.org/wiki/TCP/IP\\_model](http://en.wikipedia.org/wiki/TCP/IP_model)) to communicate between nodes. TCP/IP includes *Transmission Control Protocol (TCP)*, which is a connection-oriented protocol; *User Datagram Protocol (UDP)*, which is a connectionless protocol; and *Internet Protocol (IP)*, which is the basic protocol over which TCP and UDP perform their tasks.

The `java.net` package provides types that support TCP/IP between *processes* (executing applications) running on the same or different *hosts* (computer-based TCP/IP nodes). In this chapter, I first present the types for performing socket-based and URL-based communication. I then present the low-level network interface and interface address types and cookie-oriented types.

**Note** Android apps must have permission to access the network. Permission can be obtained by including `<uses-permission android:name="android.permission.INTERNET" />` in the app manifest file.

Network-oriented applications often have to deal with the topic of *endianness* (<http://en.wikipedia.org/wiki/Endianness>), which refers to the ordering of individually addressable sub-components within the representation of a larger data item. For example, given a 16-bit short integer, do you first transmit the most significant byte or the least significant byte?

## Accessing Networks via Sockets

Two processes communicate by way of *sockets*, which are endpoints in a communications link between these processes. Each endpoint is identified by an *IP address* that identifies the host and by a *port number* that identifies the process running on that host.

### IP ADDRESSES AND PORT NUMBERS

An *IP address* is a 32-bit or 128-bit unsigned integer that uniquely identifies a network host or some other network node (a router, for example).

It is common to specify a 32-bit IP address as four 8-bit integer components in a period-separated decimal notation, where each component is a decimal integer ranging from 0 through 255 and is separated from the next component via a period (such as 127.0.0.1). A 32-bit IP address is often referred to as an *Internet Protocol Version 4 (IPv4) address* (see <http://en.wikipedia.org/wiki/IPv4>).

It's common to specify a 128-bit IP address as eight 16-bit integer components in colon-separated hexadecimal notation, where each component is a hexadecimal integer ranging from 0 through FFFF and is separated from the next component via a colon (such as 1080:0:0:0:8:800:200C:417A). A 128-bit IP address is often referred to as an *Internet Protocol Version 6 (IPv6) address* (see <http://en.wikipedia.org/wiki/IPv6>).

A *port number* is a 16-bit integer that uniquely identifies a process, which is the ultimate source or recipient of a message. Port numbers that are less than 1024 are reserved for standard processes. For example, port number 25 has traditionally identified the Simple Mail Transfer Protocol (SMTP) process for sending e-mail, although port number 587 has largely obsoleted this older port number (see <http://en.wikipedia.org/wiki/Smtp>).

One process writes a *message* (a sequence of bytes) to its socket. The network management software portion of the underlying platform breaks the message into a sequence of *packets* (addressable message chunks that are often referred to as *IP datagrams*), and forwards them to the other process's socket where they are recombined into the original message for processing.

Figure 12-1 shows how two sockets communicate in a TCP/IP context.

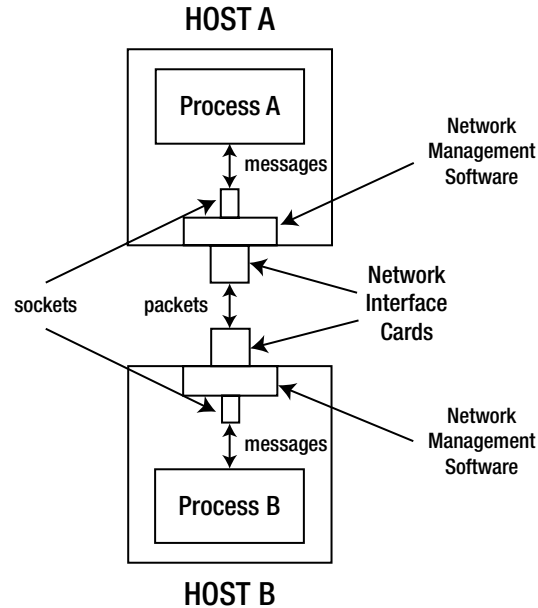

**Figure 12-1.** Two processes communicate via a pair of sockets

In the context of Figure 12-1, suppose that Process A wants to send a message to Process B. Process A sends that message to its socket with the destination socket address of Process B. Host A's network management software (often referred to as a *protocol stack*) obtains this message and reduces it to a sequence of packets, with each packet including the destination host's IP address and port number. The network management software then sends these packets through Host A's Network Interface Card (NIC) to Host B.

**Note** The NIC's various *network interfaces* are connections between a computer and a network.

Host B's protocol stack receives packets through the NIC and reassembles them into the original message (packets may be received out of order), which it then makes available to Process B via its socket. This scenario reverses when Process B communicates with Process A.

The network management software uses TCP to create an ongoing conversation between two hosts in which messages are sent back and forth. Before this conversation occurs, a connection is established between these hosts. After the connection has been established, TCP enters a pattern where it sends message packets and waits for a reply that they arrived correctly (or for a timeout to expire when the reply doesn't arrive because of some network problem). This pattern repeats and guarantees a reliable connection. For detailed information on this pattern, check out [http://en.wikipedia.org/wiki/Tcp\\_receive\\_window#Flow\\_control](http://en.wikipedia.org/wiki/Tcp_receive_window#Flow_control).

Because it can take time to establish a connection, and it also takes time to send packets (as it is necessary to receive reply acknowledgments and also because of timeouts), TCP is slow. On the other hand, UDP, which doesn't require connections and packet acknowledgement, is much faster. The downside is that UDP isn't as reliable (there's no guarantee of packet delivery, ordering, or protection against duplicate packets, although UDP uses checksums to verify that data is correct) because there's no acknowledgment. Furthermore, UDP is limited to single-packet conversations.

The `java.net` package provides `Socket`, `ServerSocket`, and other `Socket`-suffixed classes for performing TCP-based or UDP-based communications. Before investigating these classes, you need to understand socket addresses and socket options.

## Socket Addresses

An instance of a `Socket`-suffixed class is associated with a *socket address* comprised of an IP address and a port number. These classes often rely on the `InetAddress` class to represent the IPv4 or IPv6 address portion of the socket address, and represent the port number separately.

**Note** `InetAddress` relies on its `Inet4Address` subclass to represent an IPv4 address and on its `Inet6Address` subclass to represent an IPv6 address.

`InetAddress` declares several class methods for obtaining an `InetAddress` instance. These methods include the following:

- `InetAddress[] getAllByName(String host)` returns an array of `InetAddresses` that store the IP addresses associated with `host`. You can pass either a domain name (such as `tutortutor.ca`) or an IP address (such as `70.33.247.10`) argument to this parameter. (To learn about domain names, check out Wikipedia's "Domain name" entry at [http://en.wikipedia.org/wiki/Domain\\_name](http://en.wikipedia.org/wiki/Domain_name).) Pass `null` to obtain an `InetAddress` instance that stores the IP address of the *loopback interface* (a software-based network interface where outgoing data loops back as incoming data). This method throws `UnknownHostException` when no IP address for the specified host can be found, or when a scope identifier is specified for a global IPv6 address.
- `InetAddress getByAddress(byte[] addr)` returns an `InetAddress` object for the given raw IP address. The argument passed to `addr` is in *network byte order* (most significant byte comes first) where the highest order byte is stored in `addr[0]`. The `addr` array's length must be 4 bytes for an IPv4 address and 16 bytes for an IPv6 address. This method throws `UnknownHostException` when the array has another length.
- `InetAddress getByAddress(String hostName, byte[] ipAddress)` returns an `InetAddress` instance based on the host name and IP address arguments. This method throws `UnknownHostException` when the array's length is neither 4 nor 16.

- `InetAddress getByName(String host)` returns an `InetAddress` instance based on the `host` argument, which can be a machine name (such as `tutortutor.ca`) or a textual representation of its IP address. Passing `null` to `host` results in an `InetAddress` instance representing an address of the loopback interface being returned.
- `InetAddress getLocalHost()` returns the address of the *local host* (the current host), which is represented by `hostname localhost` or by an IP address that's commonly expressed as `127.0.0.1` (IPv4) or `::1` (IPv6). This method throws `UnknownHostException` when local host couldn't be resolved into an address.

After you obtain an `InetAddress` instance, you can interrogate it by invoking instance methods such as `byte[] getAddress()`, which returns the raw IP address (in network byte order) of this `InetAddress` object, and `boolean isLoopbackAddress()`, which determines whether or not this `InetAddress` instance represents a loopback address.

Java 1.4 introduced the abstract `SocketAddress` class to represent a socket address “with no protocol attachment.” (This class's creator might have anticipated that Java would eventually support low-level communication protocols other than the widely popular Internet Protocol.)

`SocketAddress` is subclassed by the concrete `InetSocketAddress` class, which represents a socket address as an IP address and a port number. It can also represent a hostname and a port number and will make an attempt to resolve the hostname.

`InetSocketAddress` instances are created by invoking `InetSocketAddress(InetAddress addr, int port)` and other constructors. After an instance has been created, you can call methods such as `InetAddress getAddress()` and `int getPort()` to return socket address components.

## Socket Options

An instance of a `Socket`-suffixed class shares the concept of *socket options*, which are parameters for configuring socket behavior. Socket options are described by constants that are declared in the `SocketOptions` interface.

- `IP_MULTICAST_IF` specifies the outgoing network interface for multicast packets (on *multihomed* [multiple NIC] hosts). This option isn't implemented by Android.
- `IP_MULTICAST_IF2` specifies the outgoing network interface for multicast packets using an interface index.
- `IP_MULTICAST_LOOP` enables or disables local loopback of multicast datagrams.
- `IP_TOS` sets the type-of-service (IPv4) or traffic class (IPv6) field in the IP header for a TCP or UDP socket.
- `SO_BINDADDR` fetches the socket's local address binding. This option isn't implemented by Android.
- `SO_BROADCAST` enables a socket to send broadcast messages.
- `SO_KEEPALIVE` turns on socket keepalive.
- `SO_LINGER` specifies the number of seconds to wait when closing a socket when there is still some buffered data to be sent.

- `SO_00BINLINE` enables inline reception of TCP urgent data.
- `SO_RCVBUF` sets or gets the maximum socket receive buffer size (in bytes).
- `SO_REUSEADDR` enables a socket's reuse address.
- `SO_SNDBUF` sets or gets the maximum socket send buffer size (in bytes).
- `SO_TIMEOUT` specifies a timeout (in milliseconds) on blocking accept or read/receive (but not write/send) socket operations. (Don't block forever!)
- `TCP_NODELAY` disables Nagle's algorithm ([http://en.wikipedia.org/wiki/Nagle's\\_algorithm](http://en.wikipedia.org/wiki/Nagle's_algorithm)). Written data to the network is not buffered pending acknowledgement of previously written data.

`SocketOptions` also declares the following methods for setting and getting these options:

- `void setOption(int optID, Object value)`
- `Object getOption(int optID)`

`optID` is one of the aforementioned constants and `value` is an object of a suitable class (such as `java.lang.Boolean`).

`SocketOptions` is implemented by the abstract `SocketImpl` and `DatagramSocketImpl` classes. Concrete instances of these classes are wrapped by the various `Socket`-suffixed classes. As a result, you cannot invoke these methods. Instead, you work with the type-safe setter and getter methods provided by the `Socket`-suffixed classes for setting and getting these options.

For example, `Socket` declares `void setKeepAlive(boolean keepAlive)` for setting the `SO_KEEPALIVE` option, and `ServerSocket` declares `void setSoTimeout(int timeout)` for setting the `SO_TIMEOUT` option. Check the documentation on the `Socket`-suffixed classes to learn about these and other socket option methods.

**Note** Socket option methods that apply to `DatagramSocket` also apply to its `MulticastSocket` subclass.

## Socket and ServerSocket

The `Socket` and `ServerSocket` classes support TCP-based communications between client processes (such as an application running on a tablet) and server processes (such as an application running on one of your Internet Service Provider's computers that provides access to the World Wide Web). Because `Socket` is associated with the `java.io.InputStream` and `java.io.OutputStream` classes, sockets based on the `Socket` class are commonly referred to as *stream sockets*.

`Socket` supports the creation of client-side sockets. It declares several constructors for this purpose, including the following pair:

- `Socket(InetAddress dstAddress, int dstPort)` creates a stream socket and connects it to the specified port number (described by `dstPort`) at the specified IP address (described by `dstAddress`). This constructor throws `java.io.IOException` when an I/O error occurs while creating the socket, `java.lang.`



`IllegalArgumentException` when the argument passed to `dstPort` is outside the valid range of port values, which is 0 through 65535, and `java.lang.NullPointerException` when `dstAddress` is null.

- `Socket(String dstName, int dstPort)` creates a stream socket and connects it to the port identified by `dstPort` on the host identified by `dstName`. When `dstName` is null, this constructor is equivalent to invoking `Socket(InetAddress.getByName(null), port)`. It throws the same `IOException` and `IllegalArgumentException` instances as the previous constructor. However, instead of throwing `NullPointerException`, it throws `UnknownHostException` when the host's IP address cannot be determined.

After a `Socket` instance is created via these constructors, it's bound to an arbitrary local host socket address before a connection is made to the remote host socket address. *Binding* makes a client socket address available to a server socket so that a server process can communicate with the client process via the server socket.

`Socket` offers additional constructors. For example, `Socket()` and `Socket(Proxy proxy)` create unbound and unconnected sockets. Before using these sockets, they must be bound to local socket addresses, by calling `void bind(SocketAddress localAddr)`, and then connections must be made, by calling `Socket`'s `connect()` methods (`void connect(SocketAddress remoteAddr)`, for example).

**Note** A *proxy* is a host that sits between an intranet and the Internet for security purposes. Proxy settings are represented via instances of the `Proxy` class and help sockets communicate through proxies.

Another constructor is `Socket(InetAddress dstAddress, int dstPort, InetAddress localAddr, int localPort)`, which lets you specify your own local host socket address via `localAddr` and `localPort`. This constructor automatically binds to the local socket address and then attempts a connection to the remote `dstPort` on `dstAddress`.

After creating a `Socket` instance, and possibly invoking `bind()` and `connect()` on that instance, an application invokes `Socket`'s `InputStream` `getInputStream()` and `OutputStream` `getOutputStream()` methods to acquire an input stream for reading bytes from the socket and an output stream for writing bytes to the socket. Also, the application often calls `Socket`'s `void close()` method to close the socket when no longer needed for I/O.

The following example demonstrates how to create a socket that's bound to port number 9999 on the local host and then access its input and output streams—exceptions are ignored for brevity:

```
Socket socket = new Socket("localhost", 9999);
InputStream is = socket.getInputStream();
OutputStream os = socket.getOutputStream();
// Do some work with the socket.
socket.close();
```

ServerSocket supports the creation of server-side sockets. It declares the following four constructors for this purpose:

- `ServerSocket()` creates an unbound server socket. You can bind this socket to a specific socket address (to which client sockets communicate) by invoking either of `ServerSocket`'s two `bind()` methods. *Binding* makes the server socket address available to a client socket so that a client process can communicate with the server process via the client socket. This constructor throws `IOException` when an I/O error occurs while attempting to open the socket.
- `ServerSocket(int port)` creates a server socket bound to the specified port value and an IP address associated with one of the host's NICs. When you pass 0 to port, an arbitrary port number is chosen. The port number can be retrieved by calling `int getLocalPort()`. The maximum queue length for incoming connection requests from clients is set to 50. If a connection request arrives when the queue is full, the connection is refused. This constructor throws `IOException` when an I/O error occurs while attempting to open the socket and `IllegalArgumentException` when port's value lies outside the specified range of valid port values, which is between 0 and 65535, inclusive.
- `ServerSocket(int port, int backlog)` is equivalent to the previous constructor, but it also lets you specify the maximum queue length for incoming connections by passing a positive integer to `backlog`.
- `ServerSocket(int port, int backlog, InetAddress localAddress)` is equivalent to the previous constructor, but it also lets you specify a different IP address to which the server socket binds. (Any address is chosen when null is passed.) This constructor is useful for machines that have multiple NICs and you want to listen for connection requests on a specific NIC.

After a server socket is created via these constructors, a server application enters a loop that first invokes `ServerSocket`'s `Socket accept()` method to listen for a connection request and return a `Socket` instance that lets it communicate with the associated client socket. It then communicates with the client socket to perform some kind of processing. When processing finishes, the server socket calls the client socket's `close()` method to terminate its connection with the client.

**Note** `ServerSocket` declares a void `close()` method for closing a server socket before terminating the server application. An unclosed socket is automatically closed when an application terminates.

The following example demonstrates how to create a server socket that's bound to port 9999 on the current host, listen for incoming connection requests, return their sockets, perform work on those sockets, and close the sockets—exceptions are ignored for brevity:

```
ServerSocket ss = new ServerSocket(9999);
while (true)
{
    Socket socket = ss.accept();
```

```

    // obtain socket input/output streams and communicate with socket
    socket.close();
}

```

The `accept()` method call blocks until a connection request is available and then returns a `Socket` object so that the server application can communicate with its associated client. The socket is closed after this communication takes place. The server socket is automatically closed when the application exits.

This example assumes that socket communication takes place on the server application's main thread, which is a problem when processing takes time to perform because server response time to incoming connection requests decreases. To speed up response time, it's often necessary to communicate with the socket on a worker thread, as demonstrated in the following example:

```

ServerSocket ss = new ServerSocket(9999);
while (true)
{
    final Socket s = ss.accept();
    new Thread(new Runnable()
        {
            @Override
            public void run()
            {
                // obtain socket input/output streams and communicate with socket
                try { s.close(); } catch (IOException ioe) {}
            }
        }
    ).start();
}

```

Each time a connection request arrives, `accept()` returns a `Socket` instance, and then a `java.lang.Thread` object is created whose `runnable` accesses that socket for communicating with the socket on a worker thread.

**Tip** Although this example uses the `Thread` class, you could use an executor (see Chapter 10) instead.

I've created `EchoClient` and `EchoServer` applications that demonstrate `Socket` and `ServerSocket`. Listing 12-1 presents `EchoClient`'s source code.

*Listing 12-1. Echoing Data to and Receiving It Back from a Server*

```

import java.io.BufferedReader;
import java.io.InputStream;
import java.io.InputStreamReader;
import java.io.IOException;
import java.io.OutputStream;
import java.io.OutputStreamWriter;
import java.io.PrintWriter;

```

```

import java.net.Socket;
import java.net.UnknownHostException;

public class EchoClient
{
    public static void main(String[] args)
    {
        if (args.length != 1)
        {
            System.err.println("usage : java EchoClient message");
            System.err.println("example: java EchoClient \"This is a test.\");
            return;
        }
        try
        {
            Socket socket = new Socket("localhost", 9999);
            OutputStream os = socket.getOutputStream();
            OutputStreamWriter osw = new OutputStreamWriter(os);
            PrintWriter pw = new PrintWriter(osw);
            pw.println(args[0]);
            pw.flush();
            InputStream is = socket.getInputStream();
            InputStreamReader isr = new InputStreamReader(is);
            BufferedReader br = new BufferedReader(isr);
            System.out.println(br.readLine());
        }
        catch (UnknownHostException uhe)
        {
            System.err.println("unknown host: " + uhe.getMessage());
        }
        catch (IOException ioe)
        {
            System.err.println("I/O error: " + ioe.getMessage());
        }
    }
}

```

EchoClient first verifies that it has received a single command-line argument and then creates a socket that will connect to a process running on port 9999 of the local host.

After creating the socket, EchoClient obtains an output stream for writing a string to the socket. Because the output stream can only handle a sequence of bytes, the `java.io.OutputStreamWriter` and `java.io.PrintWriter` classes (see Chapter 11) are used to connect the writer that outputs characters to the byte-oriented output stream.

After instantiating `PrintWriter`, EchoClient invokes its `void println(String str)` method to write the string followed by a newline character. The `void flush()` method is subsequently called to ensure that all pending data is written to the server.

EchoClient now obtains an input stream for reading the string as a sequence of bytes. It then connects the reader (that inputs characters) to the byte-oriented input stream by instantiating `java.io.InputStreamReader` and `java.io.BufferedReader` (see Chapter 11).

Finally, `EchoClient` invokes `BufferedReader`'s `String readLine()` method to read the characters followed by a newline from the socket. (`readLine()` doesn't include the newline character in the returned string.) These characters followed by a newline are then written to standard output.

**Note** In a long-running application, you would explicitly close the socket instance by invoking its `void close()` method when the socket is no longer needed. For brevity, I've chosen not to do so in this and most of the remaining `Socket`-suffixed class examples.

Listing 12-2 presents `EchoServer`'s source code.

*Listing 12-2. Receiving Data from and Echoing It Back to a Client*

```
import java.io.BufferedReader;
import java.io.InputStream;
import java.io.InputStreamReader;
import java.io.IOException;
import java.io.OutputStream;
import java.io.OutputStreamWriter;
import java.io.PrintWriter;

import java.net.ServerSocket;
import java.net.Socket;

public class EchoServer
{
    public static void main(String[] args) throws IOException
    {
        System.out.println("Starting echo server...");
        ServerSocket ss = new ServerSocket(9999);
        while (true)
        {
            Socket s = ss.accept();
            try
            {
                InputStream is = s.getInputStream();
                InputStreamReader isr = new InputStreamReader(is);
                BufferedReader br = new BufferedReader(isr);
                String msg = br.readLine();
                System.out.println(msg);
                OutputStream os = s.getOutputStream();
                OutputStreamWriter osw = new OutputStreamWriter(os);
                PrintWriter pw = new PrintWriter(osw);
                pw.println(msg);
                pw.flush();
            }
        }
    }
}
```

```

        catch (IOException ioe)
        {
            System.err.println("I/O error: " + ioe.getMessage());
        }
        finally
        {
            try
            {
                s.close();
            }
            catch (IOException ioe)
            {
                assert false; // shouldn't happen in this context
            }
        }
    }
}
}
}

```

EchoServer first outputs an introductory message to standard output and then creates a server socket that listens for connections on port 9999. It then enters an infinite loop, where each iteration invokes ServerSocket's `Socket accept()` method to block until a connection is received and then returns a `Socket` object representing this connection.

After obtaining the socket, EchoServer obtains an input stream for reading from the socket. Because the input stream can only handle a sequence of bytes, the `InputStreamReader` and `BufferedReader` classes are used to connect the reader that inputs characters to the byte-oriented input stream.

EchoServer now obtains an output stream for writing the string as a sequence of bytes. It then connects the writer that outputs characters to the byte-oriented output stream by instantiating `OutputStreamWriter` and `PrintWriter`.

After outputting the message to standard output, EchoServer calls `flush()` to flush the output to the client. The client socket is then closed.

To experiment with these applications, copy `EchoClient.java` and `EchoServer.java` to the same directory and open two console windows with this directory being current. Compile each source file and execute `java EchoServer` in one window—you should observe an introductory message, although you might first need to enable port 9999 on the *firewall* ([http://en.wikipedia.org/wiki/Firewall\\_\(computing\)](http://en.wikipedia.org/wiki/Firewall_(computing))). Having started the server, echo the following command to echo text to both windows:

```
java EchoClient "This is a test."
```

You should observe “This is a test.” in both windows.

## DatagramSocket and MulticastSocket

The `DatagramSocket` and `MulticastSocket` classes let you perform UDP-based communications between a pair of hosts (`DatagramSocket`) or between many hosts (`MulticastSocket`). With either class, you communicate one-way messages via *datagram packets*, which are arrays of bytes associated with instances of the `DatagramPacket` class.

**Note** Although you might think that `Socket` and `ServerSocket` are all that you need, `DatagramSocket` and its `MulticastSocket` subclass have their uses. For example, consider a scenario in which a group of machines need to occasionally tell a server that they're alive. It shouldn't matter when the occasional message is lost or even when the message doesn't arrive on time. Another example is a low-priority stock ticker that periodically broadcasts stock prices. When a packet doesn't arrive, odds are that the next packet will arrive and you'll then receive notification of the latest prices. Timely rather than reliable or orderly delivery is more important in real-time applications.

`DatagramPacket` declares several constructors with `DatagramPacket(byte[] buf, int length)` being the simplest. This constructor requires you to pass byte array and integer arguments to `buf` and `length`, where `buf` is a data buffer that stores data to be sent or received, and `length` (which must be less than or equal to `buf.length`) specifies the number of bytes (starting at `buf[0]`) to send/receive.

The following example demonstrates this constructor:

```
byte[] buffer = new byte[100];
DatagramPacket dgp = new DatagramPacket(buffer, buffer.length);
```

**Note** Additional constructors let you specify an offset into `buf` that identifies the storage location of the first outgoing or incoming byte, and/or let you specify a destination socket address.

`DatagramSocket` describes a socket for the client or server side of the UDP-communication link. Although this class declares several constructors, I find it convenient in this chapter to use the `DatagramSocket()` constructor for the client side and the `DatagramSocket(int port)` constructor for the server side. Either constructor throws `SocketException` when it cannot create the datagram socket or bind the datagram socket to a local port.

After an application instantiates `DatagramSocket`, it calls `void send(DatagramPacket dgp)` and `void receive(DatagramPacket dgp)` to send and receive datagram packets.

Listing 12-3 demonstrates `DatagramPacket` and `DatagramSocket` in a server context.

*Listing 12-3. Receiving Datagram Packets from and Echoing Them Back to Clients*

```
import java.io.IOException;

import java.net.DatagramPacket;
import java.net.DatagramSocket;
import java.net.SocketException;

public class DGServer
{
    final static int PORT = 10000;
```

```

public static void main(String[] args) throws SocketException
{
    System.out.println("Server is starting");
    DatagramSocket dgs = new DatagramSocket(PORT);
    try
    {
        System.out.println("Send buffer size = " + dgs.getSendBufferSize());
        System.out.println("Receive buffer size = " +
            dgs.getReceiveBufferSize());
        byte[] data = new byte[100];
        DatagramPacket dgp = new DatagramPacket(data, data.length);
        while (true)
        {
            dgs.receive(dgp);
            System.out.println(new String(data));
            dgs.send(dgp);
        }
    }
    catch (IOException ioe)
    {
        System.err.println("I/O error: " + ioe.getMessage());
    }
}
}

```

Listing 12-3's `main()` method first creates a `DatagramSocket` object and binds the socket to port 10000 on the local host. It then invokes `DatagramSocket`'s `int getSendBufferSize()` and `int getReceiveBufferSize()` methods to get the values of the `SO_SNDBUF` and `SO_RCVBUF` socket options, which are then output.

**Note** Sockets are associated with underlying platform send and receive buffers, and their sizes are accessed by calling `getSendBufferSize()` and `getReceiveBufferSize()`. Similarly, their sizes can be set by calling `DatagramSocket`'s `void setReceiveBufferSize(int size)` and `void setSendBufferSize(int size)` methods. Although you can adjust these buffer sizes to improve performance, there's a practical limit with regard to UDP. The maximum size of a UDP packet that can be sent or received is 65,507 bytes under IPv4—it's derived from subtracting the 8-byte UDP header and 20-byte IP header values from 65,535. Although you can specify a send/receive buffer with a greater value, doing so is wasteful because the largest packet is restricted to 65,507 bytes. Also, attempting to send or receive a packet with a buffer length that exceeds 65,507 bytes results in `IOException`.

`main()` next instantiates `DatagramPacket` in preparation for receiving a datagram packet from a client and then echoing the packet back to the client. It assumes that packets will be 100 bytes or less in size.

Finally, `main()` enters an infinite loop that receives a packet, outputs packet content, and sends the packet back to the client—the client's addressing information is stored in `DatagramPacket`.



Compile Listing 12-3 (`javac DGServer.java`) and run the application (`java DGServer`). You should observe output that's the same as or similar to that shown below:

```
Server is starting
Send buffer size = 8192
Receive buffer size = 8192
```

Listing 12-4 demonstrates `DatagramPacket` and `DatagramSocket` in a client context.

*Listing 12-4. Sending a Datagram Packet to and Receiving It Back from a Server*

```
import java.io.IOException;

import java.net.DatagramPacket;
import java.net.DatagramSocket;
import java.net.InetAddress;
import java.net.SocketException;

public class DGClient
{
    final static int PORT = 10000;
    final static String ADDR = "localhost";

    public static void main(String[] args) throws SocketException
    {
        System.out.println("client is starting");
        DatagramSocket dgs = new DatagramSocket();
        try
        {
            byte[] buffer;
            buffer = "Send me a datagram".getBytes();
            InetAddress ia = InetAddress.getByName(ADDR);
            DatagramPacket dgp = new DatagramPacket(buffer, buffer.length, ia,
                                                    PORT);

            dgs.send(dgp);
            byte[] buffer2 = new byte[100];
            dgp = new DatagramPacket(buffer2, buffer.length, ia, PORT);
            dgs.receive(dgp);
            System.out.println(new String(dgp.getData()));
        }
        catch (IOException ioe)
        {
            System.err.println("I/O error: " + ioe.getMessage());
        }
    }
}
```

Listing 12-4 is similar to Listing 12-3, but there's one big difference. I use the `DatagramPacket(byte[] buf, int length, InetAddress address, int port)` constructor to specify the server's destination, which happens to be port 10000 on the local host, in the datagram packet. The `send()` method call routes the packet to this destination.

Compile Listing 12-4 (`javac DGClient.java`) and run the application (`java DGClient`). Assuming that `DGServer` is also running, you should observe the following output in `DGClient`'s command window (and the last line of this output in `DGServer`'s command window):

```
client is starting
Send me a datagram
```

`MulticastSocket` describes a socket for the client or server side of a UDP-based multicasting session. Two commonly used constructors are `MulticastSocket()` (it creates a multicast socket not bound to a port) and `MulticastSocket(int port)` (it creates a multicast socket bound to the specified port). Either constructor throws `IOException` when an I/O error occurs.

## WHAT IS MULTICASTING?

Previous examples have demonstrated *unicasting*, which occurs when a server sends a message to a single client. However, it's also possible to broadcast the same message to multiple clients (such as transmit a "school closed due to bad weather" announcement to all members of a group of parents who have registered with an online program to receive this announcement); this activity is known as *multicasting*.

A server multicasts by sending a sequence of datagram packets to a special IP address, which is known as a *multicast group address*, and a specific port (as specified by a port number). Clients wanting to receive those datagram packets create a multicast socket that uses that port number. They request to join the group through a *join group operation* that specifies the special IP address. At this point, the client can receive datagram packets sent to the group and can even send datagram packets to other group members. After the client has read all datagram packets that it wants to read, it removes itself from the group by applying a *leave group operation* that specifies the special IP address.

IPv4 addresses 224.0.0.1 to 239.255.255.255 (inclusive) are reserved for use as multicast group addresses.

Listing 12-5 presents a multicasting server.

### *Listing 12-5. Multicasting Datagram Packets*

```
import java.io.IOException;

import java.net.DatagramPacket;
import java.net.InetAddress;
import java.net.MulticastSocket;

public class MCServer
{
    final static int PORT = 10000;

    public static void main(String[] args)
    {
        try
        {
            MulticastSocket mcs = new MulticastSocket();
            InetAddress group = InetAddress.getByName("231.0.0.1");
            byte[] dummy = new byte[0];
```

```

DatagramPacket dgp = new DatagramPacket(dummy, 0, group, PORT);
int i = 0;
while (true)
{
    byte[] buffer = ("line " + i).getBytes();
    dgp.setData(buffer);
    dgp.setLength(buffer.length);
    mcs.send(dgp);
    i++;
}
}
catch (IOException ioe)
{
    System.err.println("I/O error: " + ioe.getMessage());
}
}
}

```

Listing 12-5's `main()` method first creates a `MulticastSocket` instance via the `MulticastSocket()` constructor. The multicast socket doesn't need to bind to a port number because the port number is specified along with the multicast group's IP address (231.0.0.1) as part of the `DatagramPacket` instance that's subsequently created. (The `dummy` array is present to prevent a `NullPointerException` object from being thrown from the `DatagramPacket` constructor—this array isn't used to store data to be broadcasted.)

At this point, `main()` enters an infinite loop that first creates an array of bytes from a `java.lang.String` instance, and uses the platform's default character encoding (see Chapter 11) to convert from Unicode characters to bytes. (Although extraneous `java.lang.StringBuilder` and `String` objects are created via expression `"line " + i` in each loop iteration, I'm not worried about their impact on garbage collection in this short throwaway application.)

This data buffer is subsequently assigned to the `DatagramPacket` instance by calling its `void setData(byte[] buf)` method, and then the datagram packet is broadcast to all members of the group associated with port 10000 and multicast IP address 231.0.0.1.

Compile Listing 12-5 (`javac MCServer.java`) and run this application (`java MCServer`). You shouldn't observe any output.

Listing 12-6 presents a multicasting client.

**Listing 12-6. Receiving Multicast Datagram Packets**

```

import java.io.IOException;

import java.net.DatagramPacket;
import java.net.InetAddress;
import java.net.MulticastSocket;

public class MCClient
{
    final static int PORT = 10000;

```

```

public static void main(String[] args)
{
    try
    {
        MulticastSocket mcs = new MulticastSocket(PORT);
        InetAddress group = InetAddress.getByName("231.0.0.1");
        mcs.joinGroup(group);
        for (int i = 0; i < 10; i++)
        {
            byte[] buffer = new byte[256];
            DatagramPacket dgp = new DatagramPacket(buffer, buffer.length);
            mcs.receive(dgp);
            byte[] buffer2 = new byte[dgp.getLength()];
            System.arraycopy(dgp.getData(), 0, buffer2, 0, dgp.getLength());
            System.out.println(new String(buffer2));
        }
        mcs.leaveGroup(group);
    }
    catch (IOException ioe)
    {
        System.err.println("I/O error: " + ioe.getMessage());
    }
}
}

```

Listing 12-6's `main()` method first creates a `MulticastSocket` instance bound to port 10000 via the `MulticastSocket(int port)` constructor.

It then obtains an `InetAddress` object that contains multicast group IP address 231.0.0.1 and uses this object to join the group at this address by calling `MulticastSocket`'s void `joinGroup(InetAddress mcastaddr)` method.

`main()` next receives 10 datagram packets, prints their contents, and leaves the group by calling `MulticastSocket`'s void `leaveGroup(InetAddress mcastaddr)` method with the same multicast IP address as its argument.

**Note** `joinGroup()` and `leaveGroup()` throw `IOException` when an I/O error occurs while attempting to join or leave the group or when the IP address is not a multicast IP address.

Because the client doesn't know exactly how long the arrays of bytes will be, it assumes 256 bytes to ensure that the data buffer will hold the entire array. If it tried to print out the returned array, you would see a lot of empty space after the actual data had been printed.

To eliminate this space, the client invokes `DatagramPacket`'s `int getLength()` method to obtain the actual length of the array, creates a second byte array (`buffer2`) with this length, and uses `System.arraycopy()`—discussed in Chapter 7—to copy this many bytes to `buffer2`. After converting this byte array to a `String` object (via the `String(byte[] bytes)` constructor, which uses the platform's default character set—see Chapter 11 to learn about character sets), it prints the resulting characters to the standard output stream.

Compile Listing 12-6 (`javac MCClient.java`) and run this application (`java MCClient`). You should observe output similar to the following:

```
line 462615
line 462616
line 462617
line 462618
line 462619
line 462620
line 462621
line 462622
line 462623
line 462624
```

## Accessing Networks via URLs

A *Uniform Resource Locator (URL)* is a character string that specifies where a resource (such as a web page) is located on a TCP/IP-based network (such as the Internet). Also, it provides the means to retrieve that resource. For example, <http://tutortutor.ca> is a URL that locates my web site's main page. The `http://` prefix specifies that *HyperText Transfer Protocol (HTTP)*, which is a high-level protocol on top of TCP/IP for locating HTTP resources (such as web pages), must be used to retrieve the web page located at `tutortutor.ca`.

### URN, URL, AND URI

A *Uniform Resource Name (URN)* is a character string that names a resource and doesn't provide a way to access that resource (the resource might not be available). For example, `urn:isbn:9781430264545` identifies an Apress book named *Learn Java for Android Development* and that's all.

URNs and URLs are examples of *Uniform Resource Identifiers (URIs)*, which are character strings for identifying names (URNs) and resources (URLs). Every URN and URL is also a URI.

The `java.net` package provides `URL` and `URLConnection` classes for accessing URL-based resources. It also provides `URLEncoder` and `URLDecoder` classes for encoding and decoding URLs as well as the `URI` class for performing URI-based operations (such as relativization) and returning `URL` instances containing the results.

## URL and URLConnection

The `URL` class represents URLs and provides access to the resources to which they refer. Each `URL` instance unambiguously identifies an Internet resource.

`URL` declares several constructors, with `URL(String s)` being the simplest. This constructor creates a `URL` instance from the `String` argument passed to `s` and is demonstrated as follows:

```
try
{
    URL url = new URL("http://tutortutor.ca");
}
```

```
catch (MalformedURLException murle)
{
    // handle the exception
}
```

This example creates a URL object that uses HTTP to access the web page at <http://tutortutor.ca>. If I specified an illegal URL (such as `foo`), the constructor would throw `MalformedURLException` (an `IOException` subclass).

Although you'll commonly specify `http://` as the protocol prefix, this isn't your only choice. For example, you can also specify `file:///` when the resource is located on the local host. Furthermore, you can prepend `jar:` to either `http://` or `file:///` when the resource is stored in a JAR file, as demonstrated here:

```
jar:file:///C:./rt.jar!/java/util/Timer.class
```

The `jar:` prefix indicates that you want to access a JAR file resource (such as a stored classfile). The `file:///` prefix identifies the local host's resource location, which happens to be `rt.jar` (Java 5's runtime JAR file) in the current directory on the Windows C: hard drive in this example.

The path to the JAR file is followed by an exclamation mark (!) to separate the JAR file path from the JAR resource path, which happens to be the `/java/util/Timer.class` classfile entry in this JAR file (the leading `/` character is required).

**Note** The URL class in Oracle's Java reference implementation supports additional protocols, including `ftp`.

After creating a URL object, you can invoke various URL methods to access portions of the URL. For example, `String getProtocol()` returns the protocol portion of the URL (such as `http`). You can also retrieve the resource by calling the `InputStream openStream()` method.

`openStream()` creates a connection to the resource and returns an `InputStream` instance for reading resource data from that connection, as demonstrated here:

```
InputStream is = url.openStream();
int ch;
while ((ch = is.read()) != -1)
    System.out.print((char) ch);
```

**Note** For an HTTP connection, an internal socket is created that connects to HTTP port 80 on the server identified via the URL's domain name/IP address, unless you append a different port number to the domain name/IP address (such as `http://tutortutor.ca:8080`).

I've created a ListResource application that demonstrates URL by using this class to fetch a resource and list its contents. Listing 12-7 presents ListResource's source code.

*Listing 12-7. Listing the Contents of the Resource Identified via a URL Command-Line Argument*

```
import java.io.InputStream;
import java.io.IOException;

import java.net.MalformedURLException;
import java.net.URL;

public class ListResource
{
    public static void main(String[] args)
    {
        if (args.length != 1)
        {
            System.err.println("usage: java ListResource url");
            return;
        }
        try
        {
            URL url = new URL(args[0]);
            InputStream is = url.openStream();
            try
            {
                int ch;
                while ((ch = is.read()) != -1)
                    System.out.print((char) ch);
            }
            catch (IOException ioe)
            {
                is.close();
            }
        }
        catch (MalformedURLException murle)
        {
            System.err.println("invalid URL");
        }
        catch (IOException ioe)
        {
            System.err.println("I/O error: " + ioe.getMessage());
        }
    }
}
```

ListResource first verifies that it has received a single command-line argument and then attempts to instantiate URL with this argument. Assuming that the URL is valid, which means that MalformedURLException isn't thrown, ListResource calls `openStream()` on the URL instance and proceeds to list the resource contents to standard output.

Compile this source code (`javac ListResource.java`) and execute the following command to list the contents of the page at <http://tutortutor.ca>:

```
java ListResource http://tutortutor.ca
```

The following output presents a short prefix of the returned web page:

```
<!DOCTYPE html PUBLIC "-//W3C//DTD HTML 4.01//EN" "http://www.w3.org/TR/html4/strict.dtd">
<html>
  <head>
    <title>
      TutorTutor -- /main
    </title>

    <link rel="stylesheet" href="/shared/styles.css" media="screen">
```

`openStream()` is a convenience method for invoking `openConnection().getInputStream()`. Each of URL's `URLConnection` `openConnection()` and `URLConnection openConnection(Proxy proxy)` methods returns an instance of the `URLConnection` class, which represents a communications link between the application and a URL.

`URLConnection` gives you additional control over client/server communication. For example, you can use this class to output content to various resources that accept content. In contrast, URL only lets you input content via `openStream()`.

`URLConnection` declares various methods, including the following:

- `InputStream getInputStream()` returns an input stream that reads from this open connection.
- `OutputStream getOutputStream()` returns an output stream that writes to this open connection.
- `void setDoInput(boolean doInput)` specifies that this `URLConnection` object supports (pass true to `doInput`) or doesn't support (pass false to `doInput`) input. Because true is the default, you would only pass true to this method to document your intention to perform input.
- `void setDoOutput(boolean doOutput)` specifies that this `URLConnection` object supports (pass true to `doOutput`) or doesn't support (pass false to `doOutput`) output. Because false is the default, you must call this method before you can perform output.
- `void setRequestProperty(String field, String newValue)` sets a request property (such as HTTP's `accept` property). When a field already exists, its value is overwritten with the specified value.



The following example shows you how to obtain a `URLConnection` object from the `URL` object referenced by the precreated `url` variable, enable its `doOutput` property, and obtain an output stream for writing to the resource:

```
URLConnection urlc = url.openConnection();
urlc.setDoOutput(true);
OutputStream os = urlc.getOutputStream();
```

`URLConnection` is subclassed by `HttpURLConnection` and `JarURLConnection`. These classes declare constants and/or methods that are specific to working with the HTTP protocol or interacting with JAR-based resources.

For example, `HttpURLConnection` declares `void setRequestMethod(String method)` for specifying the HTTP request command to be sent to a remote HTTP server. `GET` and `POST` are commonly specified commands.

**Note** For brevity, I refer you to the Java documentation on `URLConnection`, `HttpURLConnection`, and `JarURLConnection` to learn more about these classes.

## URLEncoder and URLDecoder

HyperText Markup Language (HTML) lets you introduce forms into web pages that solicit information from page visitors. After filling out a form's fields, the visitor clicks the form's Submit button (which may specify something other than Submit) and the form content (field names and values) is sent to a server program. Before sending the form content, a web browser encodes this data by replacing spaces and other URL-illegal characters, and sets the content's Internet media type (also known as Multipurpose Internet Mail Extensions [MIME] type) to `application/x-www-form-urlencoded`.

**Note** The data is encoded for HTTP POST and HTTP GET operations. Unlike POST, GET requires a *query string* (a `?`-prefixed string containing the encoded content) to be appended to the server program's URL.

The `java.net` package provides `URLEncoder` and `URLDecoder` classes to assist you with the tasks of encoding and decoding form content.

`URLEncoder` applies the following encoding rules:

- Alphanumeric characters (a-z, A-Z, and 0-9) remain the same.
- Special characters “.”, “-”, “\*”, and “\_” remain the same.
- The space character “ ” is converted into a plus sign “+”.

- All other characters are unsafe and are first converted into 1 or more bytes using some encoding scheme. Each byte is then represented by the three-character string `%xy`, where `xy` is the 2-digit hexadecimal representation of that byte. The recommended encoding scheme to use is UTF-8. However, for compatibility reasons, the platform's default encoding is used when an encoding isn't specified.

For example, using UTF-8 as the encoding scheme, the string `"string ü@foo-bar"` is converted to `"string%C3%BC%40foo-bar"`. In UTF-8, character `ü` is encoded as 2 bytes `C3` (hex) and `BC` (hex); and character `@` is encoded as 1 byte `40` (hex).

`URLEncoder` declares the following class method for encoding a string:

```
String encode(String s, String enc)
```

This method translates the `String` argument passed to `s` into `application/x-www-form-urlencoded` format using the encoding scheme specified by `enc`. It uses the supplied encoding scheme to obtain the bytes for unsafe characters, and throws `java.io.UnsupportedEncodingException` when `enc`'s value isn't supported.

`URLDecoder` applies the following decoding rules:

- Alphanumeric characters (a-z, A-Z, and 0-9) remain the same.
- Special characters `."`, `"-"`, `"*"`, and `"_"` remain the same.
- The plus sign `"+"` is converted into a space character `" "`.
- A sequence of the form `%xy` will be treated as representing a byte, where `xy` is the 2-digit hexadecimal representation of the 8 bits. Then, all substrings containing one or more of these byte sequences consecutively will be replaced by the character(s) whose encoding would result in those consecutive bytes. The encoding scheme used to decode these characters may be specified; when unspecified, the platform's default encoding is used.

`URLDecoder` declares the following class method for decoding an encoded string:

```
String decode(String s, String enc)
```

This method decodes an `application/x-www-form-urlencoded` string using the encoding scheme specified by `enc`. The supplied encoding is used to determine what characters are represented by any consecutive sequences of the form `%xy`. `UnsupportedEncodingException` is thrown when `enc`'s value isn't supported.

There are two possible ways in which the decoder could deal with illegally encoded strings. It could either leave illegal characters alone or it could throw `IllegalArgumentException`. The approach the decoder takes is left to the implementation.

**Note** The World Wide Web Consortium recommends that UTF-8 should be used as the encoding scheme for `encode()` and `decode()`; see [www.w3.org/TR/html40/appendix/notes.html#non-ascii-chars](http://www.w3.org/TR/html40/appendix/notes.html#non-ascii-chars). Not doing so may introduce incompatibilities.

I've created an ED (Encode/Decode) application that demonstrates `URLEncoder` and `URLDecoder` in the context of the previous "string ü@foo-bar" and "string+%C3%BC%40foo-bar" example. Listing 12-8 presents the application's source code.

*Listing 12-8. Encoding and Decoding an Encoded String*

```
import java.io.UnsupportedEncodingException;

import java.net.URLDecoder;
import java.net.URLEncoder;

public class ED
{
    public static void main(String[] args) throws UnsupportedEncodingException
    {
        String encodedData = URLEncoder.encode("string ü@foo-bar", "UTF-8");
        System.out.println(encodedData);
        System.out.println(URLDecoder.decode(encodedData, "UTF-8"));
    }
}
```

When you run this application, it generates the following output:

```
string+%C3%BC%40foo-bar
string ü@foo-bar
```

**Note** Check out Wikipedia's "Percent-encoding" topic (<http://en.wikipedia.org/wiki/Percent-encoding>) to learn more about URL encoding (and the more accurate percent-encoding term).

## URI

The `URI` class represents URIs (such as URNs and URLs). It doesn't provide access to a resource when the URI is a URL.

A `URI` instance stores a character string that conforms to the following syntax at the highest level:

```
[scheme:]scheme-specific-part[#fragment]
```

This syntax reveals that every URI optionally begins with a *scheme* followed by a colon character, where a scheme can be thought of as an application-level protocol for obtaining an Internet resource. However, this definition is too narrow because it implies that the URI is always a URL. A scheme can have nothing to do with resource location. For example, `urn` is the scheme for identifying URNs.

A scheme is followed by a *scheme-specific-part* that provides an instance of the scheme. For example, given the `http://tutortutor.ca` URI, `tutortutor.ca` is an instance of the `http` scheme. Scheme-specific-parts conform to the allowable syntax of their schemes and to the overall syntax structure of a URI (including what characters can be specified literally and what characters must be encoded).

A scheme concludes with an optional #-prefixed *fragment*, which is a short string of characters that refers to a resource subordinate to another primary resource. The primary resource is identified by a URI; the fragment points to the subordinate resource. For example, `http://tutortutor.ca/document.txt#line=5,10` identifies lines 5 through 10 of a text document named `document.txt` on my web site. (This example is only illustrative; the resource doesn't actually exist.)

URIs can be categorized as absolute or relative. An *absolute URI* begins with a scheme followed by a colon character. The earlier `http://tutortutor.ca` URI is an example of an absolute URI. Other examples include `mailto:jeff@tutortutor.ca` and `news:comp.lang.java.help`. Consider an absolute URI as referring to a resource in a manner independent of the context in which that identifier appears. To use a filesystem analogy, an absolute URI is equivalent to a pathname to a file that starts from the root directory.

A *relative URI* doesn't begin with a scheme (followed by a colon character). An example is `tutorials/tutorials.html`. Consider a relative URI as referring to a resource in a manner dependent on the context in which that identifier appears. Using the filesystem analogy, the relative URI is like a pathname to a file that starts from the current directory.

URIs also can be categorized as opaque or hierarchical. An *opaque URI* is an absolute URI whose scheme-specific part doesn't begin with a forward slash (/) character. Examples include `http://tutortutor.ca` and `mailto:jeff@tutortutor.ca`. Opaque URIs aren't parsed (beyond identifying their schemes) because scheme-specific parts don't need to be validated.

A *hierarchical URI* is either an absolute URI whose scheme-specific part begins with a forward slash character, or is a relative URI. Unlike an opaque URI, a hierarchical URI's scheme-specific part must be parsed into the various components identified by the following syntax:

```
[//authority] [path] [?query] [#fragment]
```

*authority* identifies the naming authority for the URI's namespace. When present, this component begins with a pair of forward slash characters, is either server-based or registry-based, and terminates with the next forward slash character, question mark character, or no more characters—the end of the URI. Registry-based authority components have scheme-specific syntaxes (and aren't discussed because they're not commonly used), whereas server-based authority components commonly adopt the following syntax:

```
[userinfo@] host [:port]
```

This syntax specifies that a server-based authority component optionally begins with user information (such as a username) and an “at” (@) character, then continues with the host’s name, and optionally concludes with a colon character and a port. For example, `jeff@tutortutor.ca` is a server-based authority component, in which `jeff` denotes the user information and `tutortutor.ca` denotes the host—there’s no port.

*path* identifies the resource’s location according to the authority component (when present) or the scheme (when the authority component is absent). A path divides into a sequence of *path segments* (portions of the path) in which forward slash characters separate the segments. The path is absolute when the first path segment begins with a forward slash character; otherwise, the path is relative. For example, `/a/b/c` constitutes a path with three path segments—a, b, and c. Furthermore, the path is absolute because a forward slash character prefixes the first path segment (a).

*query* identifies data to be passed to the resource. The resource uses the data to obtain or produce other data that it passes back to the caller. For example, in <http://tutortutor.ca/cgi-bin/makepage.cgi?/software/Aquarium>, `/software/Aquarium` represents a query. According to that query, `/software/Aquarium` is data to be passed to a resource (`makepage.cgi`), and this data happens to be the absolute path to a directory whose same-named file is merged with boilerplate HTML by a Perl script to generate a resulting web page.

The final component is *fragment*. Although it appears to be part of a URI, it’s not. When a URI is used in a retrieval action, the primary resource that performs that action uses the fragment to retrieve the subordinate resource. For example, in `http://www.example.org/foo.html#bar`, `foo.html` is the primary resource and `bar` is the subordinate resource (the fragment). Here, `#bar` is a fragment identifier identifying `bar` as the subordinate resource.

The previous discussion reveals that a complete URI consists of scheme, authority, path, query, and fragment components; or it consists of scheme, user-info, host, port, path, query, and fragment components. To construct a URI instance in the former case, call the `URI(String scheme, String authority, String path, String query, String fragment)` constructor. In the latter case, call `URI(String scheme, String userInfo, String host, int port, String path, String query, String fragment)`.

Additional constructors are available for creating URI instances. For example, `URI(String uri)` creates a URI by parsing `uri`. Regardless of which constructor you call, it throws `java.net.URISyntaxException` when the resulting URI string has invalid syntax.

**Tip** The `java.io.File` class declares a `URI toURI()` method that you can call to convert a `File` object’s abstract pathname to a URI object. The internal URI’s scheme is set to `file`.

`URI` declares various getter methods that let you retrieve URI components. For example, `String getScheme()` lets you retrieve the scheme and `String getFragment()` returns a URL-decoded fragment. This class also declares `boolean isAbsolute()` and `boolean isOpaque()` methods that return true when a URI is absolute and opaque.

Listing 12-9 presents an application that lets you learn about URI components along with absolute and opaque URIs.

*Listing 12-9. Learning About a URI*

```
import java.net.URI;
import java.net.URISyntaxException;

public class URIComponents
{
    public static void main(String[] args) throws URISyntaxException
    {
        if (args.length != 1)
        {
            System.err.println("usage: java URIComponents uri");
            return;
        }

        URI uri = new URI(args[0]);
        System.out.println("Authority = " + uri.getAuthority());
        System.out.println("Fragment = " + uri.getFragment());
        System.out.println("Host = " + uri.getHost());
        System.out.println("Path = " + uri.getPath());
        System.out.println("Port = " + uri.getPort());
        System.out.println("Query = " + uri.getQuery());
        System.out.println("Scheme = " + uri.getScheme());
        System.out.println("Scheme-specific part = " + uri.getSchemeSpecificPart());
        System.out.println("User Info = " + uri.getUserInfo());
        System.out.println("URI is absolute: " + uri.isAbsolute());
        System.out.println("URI is opaque: " + uri.isOpaque());
    }
}
```

Compile Listing 12-9 (`javac URIComponents.java`) and execute the following command to run the application:

```
java URIComponents http://tutortutor.ca/cgi-bin/makepage.cgi?/software/Aquarium
```

You'll observe the following output:

```
Authority = tutortutor.ca
Fragment = null
Host = tutortutor.ca
Path = /cgi-bin/makepage.cgi
Port = -1
Query = /software/Aquarium
Scheme = http
Scheme-specific part = //tutortutor.ca/cgi-bin/makepage.cgi?/software/Aquarium
User Info = null
URI is absolute: true
URI is opaque: false
```

After creating a URI instance, you can perform normalization, resolution, and relativization operations (discussed shortly) on its contained URI. Although you cannot communicate via this instance, you can convert it to a URL instance for communication purposes (assuming that the URI is actually a URL and not a URN or something else) by invoking its `toURL()` method.

This method throws `IllegalArgumentException` when the URI doesn't represent an absolute URL, and throws `MalformedURLException` when a protocol handler for the URL couldn't be found (i.e., the URL doesn't start with a supported protocol such as `http` or `file`), or when some other error occurred while constructing the URL instance.

## Normalization

*Normalization* is the process of removing unnecessary `."` and `.."` path segments from a hierarchical URI's path component. Each `."` segment is removed. A `.."` segment is removed only when it's preceded by a non-`.."` segment. Normalization has no effect upon opaque URIs.

URI declares a `URI normalize()` method for normalizing a URI. This method returns a new URI object that contains the normalized equivalent of its caller's URI.

Listing 12-10 presents an application that lets you experiment with `normalize()`.

*Listing 12-10. Normalizing URIs*

```
import java.net.URI;
import java.net.URISyntaxException;

public class Normalize
{
    public static void main(String[] args) throws URISyntaxException
    {
        if (args.length != 1)
        {
            System.err.println("usage: java Normalize uri");
            return;
        }

        URI uri = new URI(args[0]);
        System.out.println("Normalized URI = " + uri.normalize());
    }
}
```

Compile Listing 12-10 (`javac Normalize.java`) and run the application as follows:

```
java Normalize a/b/../c/./d.
```

You should observe the following output, which shows that `b` isn't part of a normalized URI:

```
Normalized URI = a/c/d
```

## Resolution

*Resolution* is the process of resolving one URI against another URI, which is known as the *base*. The resulting URI is constructed from components of both URIs in the manner specified by RFC 2396 (see <http://tools.ietf.org/html/rfc2396>), taking components from the base URI for those not specified in the original URI. For hierarchical URIs, the path of the original is resolved against the path of the base and then normalized.

For example, the result of resolving original URI `docs/guide/collections/designfaq.html#28` against base URI `http://docs.oracle.com/javase/1.3/` is result URI `http://docs.oracle.com/javase/1.3/docs/guide/collections/designfaq.html#28`.

Resolution of both absolute and relative URIs, and of both absolute and relative paths in the case of hierarchical URIs, is supported.

URI declares URI `resolve(String str)` and URI `resolve(URI uri)` methods for resolving the original URI argument (passed to `str` or `uri`) against the base URI contained in the current URI object (on which this method was called). These methods return either a new URI object containing the original URI or the URI argument when the original URI is already absolute or opaque. Otherwise, they return a new URI object containing the resolved URI. `NullPointerException` is thrown when `str` or `uri` is `null`. `IllegalArgumentException` is thrown when `str` violates RFC 2396 syntax.

Listing 12-11 presents an application that lets you experiment with `resolve(String)`.

### Listing 12-11. Resolving URIs

```
import java.net.URI;
import java.net.URISyntaxException;

public class Resolve
{
    public static void main(String[] args) throws URISyntaxException
    {
        if (args.length != 2)
        {
            System.err.println("usage: java Resolve baseuri uri");
            return;
        }

        URI uri = new URI(args[0]);
        System.out.println("Resolved URI = " + uri.resolve(args[1]));
    }
}
```

Compile Listing 12-11 (`javac Resolve.java`) and run the application as follows:

```
java Resolve http://docs.oracle.com/javase/1.3/docs/guide/collections/designfaq.html#28
```

You should observe the following output:

```
Resolved URI = http://docs.oracle.com/javase/1.3/docs/guide/collections/designfaq.html#28
```



## Relativization

*Relativization* is the inverse of resolution. For any two normalized URIs, relativization undoes the work performed by resolution and resolution undoes the work performed by relativization.

URI declares a URI `relativize(URI uri)` method for relativizing its `uri` argument against the URI in the current URI object (on which this method was called)—`relativize()` throws `NullPointerException` when `uri` is `null`.

**Note** For any two normalized URI instances `u` and `v`, `u.relativize(u.resolve(v)).equals(v)` and `u.resolve(u.relativize(v)).equals(v)` evaluate to `true`.

`relativize()` performs relativization of its URI argument's URI against the URI in the URI object on which this method was called as follows:

- If either this URI or the argument URI is opaque, or if the scheme and authority components of the two URIs aren't identical, or if the path of this URI isn't a prefix of the path of the argument URI, the argument URI is returned.
- Otherwise, a new relative hierarchical URI is constructed with query and fragment components taken from the argument URI, and with a path component computed by removing this URI's path from the beginning of the argument URI's path.

Listing 12-12 presents an application that lets you experiment with `relativize()`.

### Listing 12-12. Relativizing URIs

```
import java.net.URI;
import java.net.URISyntaxException;

public class Relativize
{
    public static void main(String[] args) throws URISyntaxException
    {
        if (args.length != 2)
        {
            System.err.println("usage: java Relativize uri1 uri2");
            return;
        }

        URI uri1 = new URI(args[0]);
        URI uri2 = new URI(args[1]);
        System.out.println("Relativized URI = " + uri1.relativize(uri2));
    }
}
```

Compile Listing 12-12 (`javac Relativize.java`) and run the application as follows: `java Relativize http://docs.oracle.com/javase/1.3/ http://docs.oracle.com/javase/1.3/docs/guide/collections/designfaq.html#28`. You should observe the following output:

```
Relativized URI = docs/guide/collections/designfaq.html#28
```

## Accessing Network Interfaces and Interface Addresses

The `NetworkInterface` class represents a network interface in terms of a name (such as `le0`) and a list of IP addresses assigned to this interface. Although a network interface is often implemented on a physical NIC, it also can be implemented in software; for example, the *loopback interface* (which is useful for testing a client).

Table 12-1 presents `NetworkInterface`'s methods.

**Table 12-1.** *NetworkInterface Methods*

Method	Description
<code>boolean equals(Object obj)</code>	Compares this <code>NetworkInterface</code> object with <code>obj</code> . The result is true if and only if <code>obj</code> isn't null and represents the same network interface as this object. (Two <code>NetworkInterface</code> objects represent the same network interface when their names and addresses are the same.)
<code>static NetworkInterface getByInetAddress(InetAddress address)</code>	Returns the <code>NetworkInterface</code> corresponding to the given address or null when no interface has this address. This method throws <code>SocketException</code> when an I/O error occurs and <code>NullPointerException</code> when <code>address</code> is null.
<code>static NetworkInterface getName(String interfaceName)</code>	Returns the <code>NetworkInterface</code> with the specified name, or returns null when there's no such network interface. This method throws <code>SocketException</code> on an I/O error and <code>NullPointerException</code> when <code>interfaceName</code> is null.
<code>String getDisplayName()</code>	Returns this network interface's <i>display name</i> (a human-readable string describing the network device). On Android, this is the same string as returned by <code>getName()</code> .
<code>byte[] getHardwareAddress()</code>	Returns an array of bytes containing this network interface's hardware address, which is often referred to as the <i>media access control (MAC)</i> address. When the interface doesn't have a MAC address, or when the address cannot be accessed (perhaps the user doesn't have sufficient privileges), the method returns null. This method throws <code>SocketException</code> when an I/O error occurs.
<code>Enumeration&lt;InetAddress&gt; getInetAddresses()</code>	Returns an <i>enumeration</i> (the results of an iteration) with all or a subset of the addresses bound to this network interface.
<code>List&lt;InterfaceAddress&gt; getInterfaceAddresses()</code>	Returns a <code>java.util.List</code> containing this network interface's <code>InterfaceAddresses</code> .

(continued)

Table 12-1. (continued)

Method	Description
<code>int getMTU()</code>	Returns this network interface's <i>maximum transmission unit (MTU)</i> . This method throws <code>SocketException</code> when an I/O error occurs.
<code>String getName()</code>	Returns this network interface's name (such as <code>eth0</code> or <code>lo</code> ).
<code>static Enumeration&lt;NetworkInterface&gt; getNetworkInterfaces()</code>	Returns all of the network interfaces on this machine, or returns null when no network interfaces could be found. This method throws <code>SocketException</code> when an I/O error occurs.
<code>NetworkInterface getParent()</code>	Returns this network interface's parent <code>NetworkInterface</code> when this network interface is a subinterface. When this network interface has no parent, or when it's a physical (nonvirtual) interface, this method returns null. (A physical network interface can be logically divided into multiple <i>virtual subinterfaces</i> , which are commonly used in routing and switching. These subinterfaces can be organized into a hierarchy where the physical network interface serves as the root.)
<code>Enumeration&lt;NetworkInterface&gt; getSubInterfaces()</code>	Returns an enumeration containing the virtual subinterfaces that are attached to this network interface. For example, <code>eth0:1</code> is a subinterface of <code>eth0</code> .
<code>int hashCode()</code>	This method is overridden because <code>equals()</code> is overridden.
<code>boolean isLoopback()</code>	Returns true when this network interface reflects outgoing data back to itself as incoming data. This method throws <code>SocketException</code> when an I/O error occurs.
<code>boolean isPointToPoint()</code>	Returns true when this network interface is point-to-point (such as a PPP connection through a modem). This method throws <code>SocketException</code> when an I/O error occurs.
<code>boolean isUp()</code>	Returns true when this network interface is <i>up</i> (routing entries have been established) and <i>running</i> (platform resources have been allocated). This method throws <code>SocketException</code> when an I/O error occurs.
<code>boolean isVirtual()</code>	Returns true when this network interface is a virtual subinterface. On some platforms, virtual subinterfaces are network interfaces created as children of a physical network interface and given different settings (such as address or MTU). Usually, the name of the interface will be the name of the parent followed by a colon ( <code>:</code> ) and a number identifying the child because there can be several virtual subinterfaces attached to a single physical network interface.
<code>boolean supportsMulticast()</code>	Returns true when this network interface supports <i>multicasting</i> . This method throws <code>SocketException</code> when an I/O error occurs.
<code>String toString()</code>	Returns a string representation of this network interface.

You can use these methods to gather useful information about your platform's network interfaces. For example, Listing 12-13 presents an application that iterates over all network interfaces, invoking the methods listed in Table 12-1 that obtain the network interface's name and display name, determine if the network interface is a loopback interface, determine if the network interface is up and running, obtain the MTU, determine if the network interface supports multicasting, and enumerate all of the network interface's virtual subinterfaces.

*Listing 12-13. Enumerating All Network Interfaces*

```
import java.net.NetworkInterface;
import java.net.SocketException;

import java.util.Collections;
import java.util.Enumeration;

public class NetInfo
{
    public static void main(String[] args) throws SocketException
    {
        Enumeration<NetworkInterface> eni;
        eni = NetworkInterface.getNetworkInterfaces();
        for (NetworkInterface ni: Collections.list(eni))
        {
            System.out.println("Name = " + ni.getName());
            System.out.println("Display Name = " + ni.getDisplayName());
            System.out.println("Loopback = " + ni.isLoopback());
            System.out.println("Up and running = " + ni.isUp());
            System.out.println("MTU = " + ni.getMTU());
            System.out.println("Supports multicast = " + ni.supportsMulticast());
            System.out.println("Sub-interfaces");
            Enumeration<NetworkInterface> eni2;
            eni2 = ni.getSubInterfaces();
            for (NetworkInterface ni2: Collections.list(eni2))
                System.out.println("    " + ni2);
            System.out.println();
        }
    }
}
```

**Tip** The `java.util.Collections` class's `ArrayList<T> list(Enumeration<T> enumeration)` method is useful for converting a legacy enumeration to a modern array list.

Compile Listing 12-13 (`javac NetInfo.java`) and execute this application (`java NetInfo`). When I run `NetInfo` on my Windows 7 platform, I observe information that begins with the following output:

```
Name = lo
Display Name = Software Loopback Interface 1
Loopback = true
```

```

Up and running = true
MTU = -1
Supports multicast = true
Sub-interfaces

Name = net0
Display Name = WAN Miniport (SSTP)
Loopback = false
Up and running = false
MTU = -1
Supports multicast = true
Sub-interfaces

```

The complete output reveals a different MTU size for a few network interfaces. Each size represents the maximum length of a message that can fit into an *IP datagram* without needing to fragment the message into multiple IP datagrams. This fragmentation has performance implications, especially in the context of networked games. For this reason alone, the `getMTU()` method is a valuable member of `NetworkInterface`.

The `getInterfaceAddresses()` method returns a list of `InterfaceAddress` objects, with each object containing a network interface's IP address along with broadcast address and subnet mask (IPv4) or network prefix length (IPv6).

Table 12-2 presents `InterfaceAddress`'s methods.

**Table 12-2. InterfaceAddress Methods**

Method	Description
<code>boolean equals(Object obj)</code>	Compares this <code>InterfaceAddress</code> object with <code>obj</code> . Returns true when <code>obj</code> is also an <code>InterfaceAddress</code> , and when both objects contain the same <code>InetAddress</code> , the same subnet masks/network prefix lengths (depending on IPv4 or IPv6), and the same broadcast addresses.
<code>InetAddress getAddress()</code>	Returns this <code>InterfaceAddress</code> 's IP address, as an <code>InetAddress</code> object.
<code>InetAddress getBroadcast()</code>	Returns this <code>InterfaceAddress</code> 's broadcast address (IPv4) or null (IPv6); IPv6 doesn't support broadcast addresses.
<code>short getNetworkPrefixLength()</code>	Returns this <code>InterfaceAddress</code> 's network prefix length (IPv6) or subnet mask (IPv4). Oracle's Java documentation shows 128 (::1/128) and 10 (fe80::203:baff:fe27:1243/10) as typical IPv6 values. Typical IPv4 values are 8 (255.0.0.0), 16 (255.255.0.0), and 24 (255.255.255.0).
<code>int hashCode()</code>	Returns this <code>InterfaceAddress</code> 's hash code. The hash code is a combination of the <code>InetAddress</code> 's hash code, the broadcast address (when present) hash code, and the network prefix length.
<code>String toString()</code>	Returns a string representation of this <code>InterfaceAddress</code> . This representation has the form <i>InetAddress / network prefix length [broadcast address]</i> .

Listing 12-14, which extends Listing 12-13 (with a few lines removed), enumerates all network interfaces, outputting their display names, and enumerates each network interface's interface addresses, outputting interface address information.

*Listing 12-14. Enumerating All Network Interfaces and Interface Addresses*

```
import java.net.InterfaceAddress;
import java.net.NetworkInterface;
import java.net.SocketException;

import java.util.Collections;
import java.util.Enumeration;
import java.util.Iterator;
import java.util.List;

public class NetInfo
{
    public static void main(String[] args) throws SocketException
    {
        Enumeration<NetworkInterface> eni;
        eni = NetworkInterface.getNetworkInterfaces();
        for (NetworkInterface ni: Collections.list(eni))
        {
            System.out.println("Name = " + ni.getName());
            List<InterfaceAddress> ias = ni.getInterfaceAddresses();
            Iterator<InterfaceAddress> iter = ias.iterator();
            while (iter.hasNext())
                System.out.println(iter.next());
            System.out.println();
        }
    }
}
```

Compile Listing 12-14 (`javac NetInfo.java`) and execute this application (`java NetInfo`). When I run `NetInfo` on my Windows 7 platform, I observe the following information:

```
Name = lo
/127.0.0.1/8 [/127.255.255.255]
/0:0:0:0:0:0:0:1/128 [null]

Name = net0

Name = net1

Name = net2

Name = ppp0

Name = eth0

Name = eth1
```

```

Name = eth2

Name = ppp1

Name = net3

Name = eth3
/192.xxx.xxx.xxx/xx [/192.xxx.xxx.xxx]
/fe80:0:0:0:xxxx:xxxx:xxxx:xxxx%xx/xx [null]

Name = net4
/fe80:0:0:0:0:xxxx:xxxx:xxxx%xx/xxx [null]

Name = net5
/2001:0:xxxx:xxxx:xxxx:xxxx:xxxx:xxxx/x [null]
/fe80:0:0:0:xxxx:xxxx:xxxx:xxxx%xx/xx [null]

Name = eth4

Name = eth5

Name = eth6

Name = eth7

Name = eth8

```

## Managing Cookies

Server applications commonly use *HTTP cookies* (state objects)—*cookies* for short—to persist small amounts of information on clients. For example, the identifiers of currently selected items in a shopping cart can be stored as cookies. It's preferable to store cookies on the client rather than on the server because of the potential for millions of cookies (depending on a web site's popularity). In that case, not only would a server require a massive amount of storage just for cookies, but also searching for and maintaining cookies would be time consuming.

**Note** Check out Wikipedia's "HTTP cookie" entry ([http://en.wikipedia.org/wiki/HTTP\\_cookie](http://en.wikipedia.org/wiki/HTTP_cookie)) for a quick refresher on cookies.

A server application sends a cookie to a client as part of an HTTP response. A client (such as a web browser) sends a cookie to the server as part of an HTTP request. Before Java 5, applications worked with the `URLConnection` class (and its `HttpURLConnection` subclass) to get an HTTP response's cookies and to set an HTTP request's cookies. The `String getHeaderFieldKey(int n)` and `String getHeaderField(int n)` methods were used to access a response's `Set-Cookie` headers, and the `void setRequestProperty(String key, String value)` method was used to create a request's `Cookie` header.

**Note** “RFC 2109: HTTP State Management Mechanism” ([www.ietf.org/rfc/rfc2109.txt](http://www.ietf.org/rfc/rfc2109.txt)) describes the Set-Cookie and Cookie headers.

Java 5 introduced the abstract `CookieHandler` class as a callback mechanism that connects HTTP state management to an HTTP protocol handler (think concrete `URLConnection` subclass). An application installs a concrete `CookieHandler` subclass as the system-wide cookie handler via the `CookieHandler` class’s `void setDefault(CookieHandler cHandler)` class method. A companion `CookieHandler getDefault()` class method returns this cookie handler, which is null when a system-wide cookie handler hasn’t been installed.

An HTTP protocol handler accesses response and request headers. This handler invokes the system-wide cookie handler’s `void put(URI uri, Map<String, List<String>> responseHeaders)` method to store response cookies in a cookie cache and invokes the `Map<String, List<String>> get(URI uri, Map<String, List<String>> requestHeaders)` method to fetch request cookies from this cache. Unlike Java 5, Java 6 introduced a concrete implementation of `CookieHandler` so that HTTP protocol handlers and applications can work with cookies.

The concrete `CookieManager` class extends `CookieHandler` to manage cookies. This class does not interact with the web browser’s cookies (stored on the client computer). Instead, it represents a separate and distinct cookie manager.

A `CookieManager` object is initialized as follows:

- With a *cookie store* for storing cookies. The cookie store is based on the `CookieStore` interface.
- With a *cookie policy* for determining which cookies to accept for storage. The cookie policy is based on the `CookiePolicy` interface.

Create a cookie manager by calling either the `CookieManager()` constructor or the `CookieManager(CookieStore store, CookiePolicy policy)` constructor. The `CookieManager()` constructor invokes the latter constructor with null arguments, using the default in-memory cookie store and the default `accept-cookies-from-the-original-server-only` cookie policy. Unless you plan to create your own `CookieStore` and `CookiePolicy` implementations, you’ll most likely work with the default constructor. The following example creates and establishes a new `CookieManager` object as the system-wide cookie handler:

```
CookieHandler.setDefault(new CookieManager());
```

Along with the aforementioned constructors, `CookieManager` declares the following methods:

- `Map<String, List<String>> get(URI uri, Map<String, List<String>> requestHeaders)` returns an immutable map of `Cookie` and `Cookie2` request headers for cookies obtained from the cookie store whose path matches `uri`’s path. Although `requestHeaders` isn’t used by the default implementation of this method, it can be used by subclasses. `IOException` is thrown when an I/O error occurs.
- `CookieStore getCookieStore()` returns the cookie manager’s cookie store.



- `void put(URI uri, Map<String, List<String>> responseHeaders)` stores all applicable cookies whose `Set-Cookie` and `Set-Cookie2` response headers were retrieved from the specified `uri` value and placed (with all other response headers) in the immutable `responseHeaders` map in the cookie store. `IOException` is thrown when an I/O error occurs.
- `void setCookiePolicy(CookiePolicy cookiePolicy)` sets the cookie manager's cookie policy to one of `CookiePolicy.ACCEPT_ALL` (accept all cookies), `CookiePolicy.ACCEPT_NONE` (accept no cookies), or `CookiePolicy.ACCEPT_ORIGINAL_SERVER` (accept cookies from original server only—this is the default). Passing null to this method has no effect on the current policy.

In contrast to the `get()` and `put()` methods, which are called by HTTP protocol handlers, an application works with the `getCookieStore()` and `setCookiePolicy()` methods. Consider Listing 12-15.

*Listing 12-15. Listing All Cookies for a Specific Domain*

```
import java.io.IOException;

import java.net.CookieHandler;
import java.net.CookieManager;
import java.net.CookiePolicy;
import java.net.HttpCookie;
import java.net.URL;

import java.util.List;

public class ListAllCookies
{
    public static void main(String[] args) throws IOException
    {
        if (args.length != 1)
        {
            System.err.println("usage: java ListAllCookies url");
            return;
        }
        CookieManager cm = new CookieManager();
        cm.setCookiePolicy(CookiePolicy.ACCEPT_ALL);
        CookieHandler.setDefault(cm);
        new URL(args[0]).openConnection().getContent();
        List<HttpCookie> cookies = cm.getCookieStore().getCookies();
        for (HttpCookie cookie: cookies)
        {
            System.out.println("Name = " + cookie.getName());
            System.out.println("Value = " + cookie.getValue());
            System.out.println("Lifetime (seconds) = " + cookie.getMaxAge());
            System.out.println("Path = " + cookie.getPath());
            System.out.println();
        }
    }
}
```

Listing 12-15 describes a command-line application that obtains and lists all cookies from its single domain name argument. After creating a cookie manager and invoking `setCookiePolicy()` to set the cookie manager's policy to accept all cookies, `ListAllCookies` installs the cookie manager as the system-wide cookie handler. It next connects to the domain identified by the command-line argument and reads the content (via URL's `Object getContent()` method).

The cookie store is obtained via `getCookieStore()` and used to retrieve all nonexpired cookies via its `List<HttpCookie> getCookies()` method. For each of these `HttpCookies`, `String getName()`, `String getValue()`, and other `HttpCookie` methods are invoked to return cookie-specific information.

Compile Listing 12-15 (`javac ListAllCookies.java`). The following output resulted from invoking `java ListAllCookies http://java.dzone.com`:

```
Name = SESS374e8db54ec3033c25a586b1d093b1d1
Value = irhqtiemls4cp0vf5pe1p0oeo7
Lifetime (seconds) = 2000000
Path = /
```

**Note** For more information about cookie management, including examples that show you how to create your own `CookiePolicy` and `CookieStore` implementations, check out *The Java Tutorial's* "Working With Cookies" lesson (<http://docs.oracle.com/javase/tutorial/networking/cookies/index.html>).

## EXERCISES

The following exercises are designed to test your understanding of Chapter 12's content.

1. Define network.
2. What is an intranet and what is an internet?
3. What do intranets and internets often use to communicate between nodes?
4. Define host.
5. What is a socket?
6. How is a socket identified?
7. Define IP address.
8. What is a packet?
9. A socket address is comprised of what elements?
10. Identify the `InetAddress` subclasses that are used to represent IPv4 and IPv6 addresses.
11. What is the loopback interface?
12. True or false: In network byte order, the least significant byte comes first.

13. How is the local host represented?
14. Define socket option.
15. How are socket options described?
16. True or false: You set a socket option by calling the void `setOption(int optID, Object value)` method.
17. Why are sockets based on the `Socket` class commonly referred to as stream sockets?
18. What does binding accomplish in the context of a `Socket` instance?
19. Define proxy. How does Java represent proxy settings?
20. True or false: The `ServerSocket()` constructor creates a bound sever socket.
21. What is the difference between the `DatagramSocket` and `MulticastSocket` classes?
22. What is a datagram packet?
23. What is the difference between unicasting and multicasting?
24. What is a URL?
25. What is a URN?
26. True or false: URLs and URNs are also URIs.
27. What does the `URL(String s)` constructor do when you pass null to `s`?
28. What is the equivalent of `openStream()`?
29. True or false: You need to invoke `URLConnection`'s void `setDoInput(boolean doInput)` method with `true` as the argument before you can input content from a web resource.
30. What does `URLEncoder` do when it encounters a space character?
31. What is the purpose of the `URI` class?
32. Define normalization.
33. True or false: Resolution and relativization are inverse operations of each other.
34. What does the `NetworkInterface` class accomplish?
35. What is a MAC address?
36. What does MTU stand for and what is its purpose?
37. True or false: `NetworkInterface`'s `getName()` method returns a human-readable name.
38. What does `InterfaceAddress`'s `getNetworkPrefixLength()` method return under IPv4?
39. Define HTTP Cookie.
40. Why is it preferable to store cookies on the client rather than on the server?
41. Identify the four `java.net` types that are used to work with cookies.

42. Modify Listing 12-1's `EchoClient` source code to explicitly close the socket.
  43. Modify Listing 12-2's `EchoServer` source code to exit the while loop and explicitly close the server socket when a file named `kill` appears in the directory from which the server was started. After this file appears, the server will probably not die immediately because it's most likely waiting (via the `accept()` call) for an incoming client connection. However, it should die after servicing the next incoming connection.
- 

## Summary

A network is a group of interconnected nodes that can be shared among the network's users. An *intranet* is a network located within an organization and an *internet* is a network connecting organizations to each other. The *Internet* is the global network of networks.

The `java.net` package provides types that support TCP/IP between processes running on the same or different hosts. Two processes communicate by way of sockets, which are endpoints in a communications link between these processes. Each endpoint is identified by an IP address that identifies a host and by a port number that identifies the process running on that host.

One process writes a message to its socket, the network management software portion of the underlying operating system breaks the message into a sequence of packets that it forwards to the other process's socket, and the other process recombines received packets into the original message for its own processing.

The network management software uses TCP to create an ongoing conversation between two hosts in which messages are sent back and forth. Before this conversation occurs, a connection is established between these hosts. After the connection has been established, TCP enters a pattern where it sends message packets and waits for a reply that they arrived correctly (or for a timeout to expire when the reply doesn't arrive because of some network problem). This pattern repeats and guarantees a reliable connection.

Because it can take time to establish a connection, and it also takes time to send packets (as it is necessary to receive reply acknowledgments, and also because of timeouts), TCP is slow. On the other hand, UDP, which doesn't require connections and packet acknowledgement, is much faster. The downside is that UDP isn't as reliable (there's no guarantee of packet delivery, ordering, or protection against duplicate packets, although UDP uses checksums to verify that data is correct) because there's no acknowledgment. Furthermore, UDP is limited to single-packet conversations.

An instance of a `Socket`-suffixed class is associated with a socket address comprised of an IP address and a port number. These classes often rely on the `InetAddress` class to represent the IPv4 or IPv6 address portion of the socket address, and represent the port number separately.

An instance of a `Socket`-suffixed class shares the concept of socket options, which are parameters for configuring socket behavior. Socket options are described by constants that are declared in the `SocketOptions` interface.

The `Socket` and `ServerSocket` classes support TCP-based communications between client processes and server processes. `Socket` supports the creation of client-side sockets, whereas `ServerSocket` supports the creation of server-side sockets.

The `DatagramSocket` and `MulticastSocket` classes let you perform UDP-based communications between a pair of hosts (`DatagramSocket`) or between as many hosts as necessary (`MulticastSocket`). With either class, you communicate one-way messages via datagram packets.

Two processes communicating via sockets demonstrate low-level network access. Java also supports high-level access via URLs that identify resources and specify where they are located on TCP/IP-based networks.

URLs are represented by the `URL` class, which provides access to the resources to which they refer. `URLConnection` gives you additional control over client/server communication. For example, you can use this class to output content to various resources that accept content. In contrast, `URL` only lets you input content via `openStream()`.

HTML lets you introduce forms into web pages that solicit information from page visitors. The `java.net` package provides `URLEncoder` and `URLDecoder` classes to assist you with the tasks of encoding and decoding form content.

URLs are a form of URI, which is a character string that identifies a resource without providing access to the resource, or identifies a name. URIs are represented by the `URI` class, which provides methods for extracting parts of a URI (such as the scheme), and for performing normalization, resolution, and relativization operations.

The `NetworkInterface` class represents a network interface in terms of a name (such as `le0`) and a list of IP addresses assigned to this interface. `NetworkInterface`'s `getInterfaceAddresses()` method returns a list of `InterfaceAddress` objects, with each object containing a network interface's IP address along with broadcast address and subnet mask (IPv4) or network prefix length (IPv6).

Server applications commonly use HTTP cookies (state objects)—cookies, for short—to persist small amounts of information on clients. Java provides the `CookieHandler` and `CookieManager` classes and the `CookiePolicy` and `CookieStore` interfaces for working with cookies.

This chapter focused on I/O in a network context. `New I/O` lets you perform file-based and network-based I/O in a more performant manner. Chapter 13 introduces you to Java's `New I/O` APIs.

# Migrating to New I/O

Chapters 11 and 12 introduced you to Java's classic I/O APIs. Chapter 11 presented classic I/O in terms of `java.io`'s `File`, `RandomAccessFile`, `stream`, and `writer/reader` types. Chapter 12 presented classic I/O in terms of `java.net`'s `socket` and `URL` types.

Modern operating systems offer powerful I/O features that are not supported by Java's classic I/O APIs. Features include *memory-mapped file I/O* (the ability to map part of a *process* (executing application)'s *virtual memory* (see [http://en.wikipedia.org/wiki/Virtual\\_memory](http://en.wikipedia.org/wiki/Virtual_memory)) to some portion of a file so that writes to or reads from that portion of the process's memory space actually write/read the associated portion of the file), *readiness selection* (a step above nonblocking I/O that offloads to the operating system the work involved in checking for I/O stream readiness to perform write and read operations), and *file locking* (the ability for one process to prevent other processes from accessing a file or to limit the access in some way).

Java 1.4 introduced a more powerful I/O architecture that supports memory-mapped file I/O, readiness selection, file locking, and more. This architecture largely consists of buffers, channels, selectors, regular expressions, and charsets, and it is commonly known as *New I/O (NIO)*.

**Note** Regular expressions are included as part of NIO (see JSR 51 at <http://jcp.org/en/jsr/detail?id=51>) because NIO is all about performance, and regular expressions are useful for scanning text (read from an I/O source) in a highly performant manner.

In this chapter, I introduce you to NIO in terms of buffers, channels, selectors, regular expressions, and charsets. I also discuss the simple `printf`-style formatting facility proposed in JSR 51 but not implemented until Java 5.

## Working with Buffers

NIO is based on buffers. A *buffer* is an object that stores a fixed amount of data to be sent to or received from an *I/O service* (a means for performing input/output). It sits between an application and a *channel* that writes the buffered data to the service or reads the data from the service and deposits it into the buffer.

Buffers possess four properties:

- *Capacity*: The total number of data items that can be stored in the buffer. The capacity is specified when the buffer is created and cannot be changed later.
- *Limit*: The number of “live” data items in the buffer. No items starting from the zero-based limit should be written or read.
- *Position*: The zero-based index of the next data item that can be read or the location where the data item can be written.
- *Mark*: A zero-based position that can be recalled. The mark is initially undefined.

These four properties are related as follows:

$$0 \leq \text{mark} \leq \text{position} \leq \text{limit} \leq \text{capacity}$$

Figure 13-1 reveals a newly created and byte-oriented buffer with a capacity of 7.

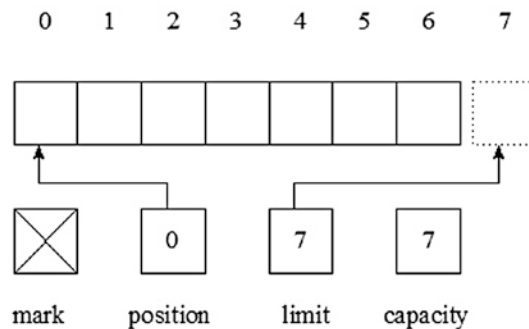

**Figure 13-1.** The logical layout of a byte-oriented buffer includes an undefined mark, a current position, a limit, and a capacity

Figure 13-1’s buffer can store a maximum of seven elements. The mark is initially undefined, the position is initially set to 0, and the limit is initially set to the capacity (7), which specifies the maximum number of bytes that can be stored in the buffer. You can only access positions 0 through 6. Position 7 lies beyond the buffer.

## Buffer and Its Children

Buffers are implemented by classes that are derived from the abstract `java.nio.Buffer` class. Table 13-1 describes Buffer’s methods.

**Table 13-1. Buffer Methods**

Method	Description
<code>Object array()</code>	Returns the array that backs this buffer. This method is intended to allow array-backed buffers to be passed to <i>native code</i> more efficiently. Concrete subclasses override this method and provide more strongly typed return values via covariant return types (discussed in Chapter 4). This method throws <code>java.nio.ReadOnlyBufferException</code> when this buffer is backed by an array but is read only and throws <code>java.lang.UnsupportedOperationException</code> when this buffer isn't backed by an accessible array.
<code>int arrayOffset()</code>	Returns the offset of the first buffer element within this buffer's backing array. When this buffer is backed by an array, buffer position <code>p</code> corresponds to array index <code>p + arrayOffset()</code> . Invoke <code>hasArray()</code> before invoking this method to ensure that this buffer has an accessible backing array. This method throws <code>ReadOnlyBufferException</code> when this buffer is backed by an array but is read only and throws <code>UnsupportedOperationException</code> when this buffer isn't backed by an accessible array.
<code>int capacity()</code>	Returns this buffer's capacity.
<code>Buffer clear()</code>	Clears this buffer. The position is set to 0, the limit is set to the capacity, and the mark is discarded. This method doesn't erase the data in the buffer but is named as if it did because it will most often be used in situations in which that might as well be the case.
<code>Buffer flip()</code>	Flips this buffer. The limit is set to the current position and then the position is set to 0. When the mark is defined, it's discarded.
<code>boolean hasArray()</code>	Returns true when this buffer is backed by an array and isn't read-only; otherwise, returns false. When this method returns true, <code>array()</code> and <code>arrayOffset()</code> may be invoked safely.
<code>boolean hasRemaining()</code>	Returns true when at least one element remains in this buffer (that is, between the current position and the limit); otherwise, returns false.
<code>boolean isDirect()</code>	Returns true when this buffer is a direct byte buffer (discussed later in this section); otherwise, returns false.
<code>boolean isReadOnly()</code>	Returns true when this buffer is read-only; otherwise, returns false.
<code>int limit()</code>	Returns this buffer's limit.
<code>Buffer limit(int newLimit)</code>	Sets this buffer's limit to <code>newLimit</code> . When the position is larger than <code>newLimit</code> , the position is set to <code>newLimit</code> . When the mark is defined and is larger than <code>newLimit</code> , the mark is discarded. This method throws <code>java.lang.IllegalArgumentException</code> when <code>newLimit</code> is negative or larger than this buffer's capacity; otherwise, it returns this buffer.
<code>Buffer mark()</code>	Sets this buffer's mark to its position and returns this buffer.
<code>int position()</code>	Returns this buffer's position.

(continued)



**Table 13-1.** (continued)

Method	Description
<code>Buffer position(int newPosition)</code>	Sets this buffer's position to <code>newPosition</code> . When the mark is defined and is larger than <code>newPosition</code> , the mark is discarded. This method throws <code>IllegalArgumentException</code> when <code>newPosition</code> is negative or larger than this buffer's current limit; otherwise, it returns this buffer.
<code>int remaining()</code>	Returns the number of elements between the current position and the limit.
<code>Buffer reset()</code>	Resets this buffer's position to the previously marked position. Invoking this method neither changes nor discards the mark's value. This method throws <code>java.nio.InvalidMarkException</code> when the mark hasn't been set; otherwise, it returns this buffer.
<code>Buffer rewind()</code>	Rewinds and then returns this buffer. The position is set to 0 and the mark is discarded.

Table 13-1 shows that many of `Buffer`'s methods return `Buffer` references so that you can chain instance method calls together. (See Chapter 3 for a discussion on instance method call chaining.) For example, instead of specifying the following three lines,

```
buf.mark();
buf.position(2);
buf.reset();
```

you can more conveniently specify the following line:

```
buf.mark().position(2).reset();
```

Table 13-1 also shows that all buffers can be read but not all buffers can be written—for example, a buffer backed by a memory-mapped file that's read-only. You must not write to a read-only buffer; otherwise, `ReadOnlyBufferException` is thrown. Call `isReadOnly()` when you're unsure that a buffer is writable before attempting to write to that buffer.

**Caution** Buffers are not thread-safe. You must employ synchronization when you want to access a buffer from multiple threads.

The `java.nio` package includes several abstract classes that extend `Buffer`, one for each primitive type except for `Boolean`: `ByteBuffer`, `CharBuffer`, `DoubleBuffer`, `FloatBuffer`, `IntBuffer`, `LongBuffer`, and `ShortBuffer`. Furthermore, this package includes `MappedByteBuffer` as an abstract `ByteBuffer` subclass.

**Note** Operating systems perform byte-oriented I/O, and you use `ByteBuffer` to create byte-oriented buffers that store the bytes to write to a destination or that are read from a source. The other primitive-type buffer classes let you create multibyte view buffers (discussed later) so that you can conceptually perform I/O in terms of characters, double precision floating-point values, 32-bit integers, and so on. However, the I/O operation is really being carried out as a flow of bytes.

Listing 13-1 demonstrates the `Buffer` class in terms of `ByteBuffer`, capacity, limit, position, and remaining elements.

*Listing 13-1. Demonstrating a Byte-Oriented Buffer*

```
import java.nio.Buffer;
import java.nio.ByteBuffer;

public class BufferDemo
{
    public static void main(String[] args)
    {
        Buffer buffer = ByteBuffer.allocate(7);
        System.out.println("Capacity: " + buffer.capacity());
        System.out.println("Limit: " + buffer.limit());
        System.out.println("Position: " + buffer.position());
        System.out.println("Remaining: " + buffer.remaining());
        System.out.println("Changing buffer limit to 5");
        buffer.limit(5);
        System.out.println("Limit: " + buffer.limit());
        System.out.println("Position: " + buffer.position());
        System.out.println("Remaining: " + buffer.remaining());
        System.out.println("Changing buffer position to 3");
        buffer.position(3);
        System.out.println("Position: " + buffer.position());
        System.out.println("Remaining: " + buffer.remaining());
        System.out.println(buffer);
    }
}
```

Listing 13-1's `main()` method first needs to obtain a buffer. It cannot instantiate the `Buffer` class because that class is abstract. Instead, it uses the `ByteBuffer` class and its `allocate()` class method to allocate the 7-byte buffer shown in Figure 13-1. `main()` then calls assorted `Buffer` methods to demonstrate capacity, limit, position, and remaining elements.

Compile Listing 13-1 as follows:

```
javac BufferDemo.java
```

Run this application as follows:

```
java BufferDemo
```

You should observe the following output:

```
Capacity: 7
Limit: 7
Position: 0
Remaining: 7
Changing buffer limit to 5
Limit: 5
Position: 0
Remaining: 5
Changing buffer position to 3
Position: 3
Remaining: 2
java.nio.HeapByteBuffer[pos=3 lim=5 cap=7]
```

The final output line reveals that the `ByteBuffer` instance assigned to `buffer` is actually an instance of the package-private `java.nio.HeapByteBuffer` class.

## Buffers in Depth

The previous discussion of the `Buffer` class has given you some insight into NIO buffers. However, there's much more to explore. This section takes you deeper into buffers by exploring buffer creation, buffer writing and reading, buffer flipping, buffer marking, `Buffer` subclass operations, byte ordering, and direct buffers.

**Note** Although the primitive-type buffer classes have similar capabilities, `ByteBuffer` is the largest and most versatile. After all, bytes are the basic unit used by operating systems to transfer data items. I'll therefore use `ByteBuffer` to demonstrate most buffer operations. I'll also use `CharBuffer` to add variety.

## Buffer Creation

`ByteBuffer` and the other primitive-type buffer classes declare various class methods for creating a buffer of that type. For example, `ByteBuffer` declares the following class methods for creating `ByteBuffer` instances:

- `ByteBuffer allocate(int capacity)`: Allocates a new byte buffer with the specified capacity value. Its position is 0, its limit is its capacity, its mark is undefined, and each element is initialized to 0. It has a backing array, and its array offset is 0. This method throws `IllegalArgumentException` when capacity is negative.
- `ByteBuffer allocateDirect(int capacity)`: Allocates a new direct byte buffer with the specified capacity value. Its position is 0, its limit is its capacity, its mark is undefined, and each element is initialized to 0. Whether or not it has a backing array is unspecified. This method throws `IllegalArgumentException` when capacity is negative.

- `ByteBuffer wrap(byte[] array)`: Wraps a byte array into a buffer. The new buffer is backed by array; that is, modifications to the buffer will cause the array to be modified and vice versa. The new buffer's capacity and limit are set to `array.length`, its position is set to 0, and its mark is undefined. Its array offset is 0.
- `ByteBuffer wrap(byte[] array, int offset, int length)`: Wraps a byte array into a buffer. The new buffer is backed by array. The new buffer's capacity is set to `array.length`, its position is set to `offset`, its limit is set to `offset + length`, and its mark is undefined. Its array offset is 0. This method throws `java.lang.IndexOutOfBoundsException` when `offset` is negative or greater than `array.length` or when `length` is negative or greater than `array.length - offset`.

These methods show two ways to create a byte buffer: create the `ByteBuffer` object and allocate an internal array that stores capacity bytes or create the `ByteBuffer` object and use the specified array to store these bytes. Consider these examples:

```
ByteBuffer buffer = ByteBuffer.allocate(10);
byte[] bytes = new byte[200];
ByteBuffer buffer2 = ByteBuffer.wrap(bytes);
```

The first line creates a byte buffer with an internal byte array that stores a maximum of 10 bytes, and the second and third lines create a byte array and a byte buffer that uses this array to store a maximum of 200 bytes.

Now consider the following example, which extends the previous example:

```
buffer = ByteBuffer.wrap(bytes, 10, 50);
```

This example creates a byte buffer with a position of 10, a limit of 50, and a capacity of `bytes.length` (which happens to be 200). Although it appears that the buffer can only access a subrange of this array, it actually has access to the entire array: values 10 and 50 are only the starting values for the position and limit.

`ByteBuffers` (and other primitive type buffers) created via `allocate()` or `wrap()` are nondirect byte buffers; you'll learn about direct byte buffers later. Nondirect byte buffers have backing arrays, and you can access these backing arrays via the `array()` method (which happens to be declared as `byte[] array()` in the `ByteArray` class) as long as `hasArray()` returns true. (When `hasArray()` returns true, you'll need to call `arrayOffset()` to obtain the location of the first data item in the array.)

Listing 13-2 demonstrates buffer allocation and wrapping.

*Listing 13-2. Creating Byte-Oriented Buffers via Allocation and Wrapping*

```
import java.nio.ByteBuffer;

public class BufferDemo
{
    public static void main(String[] args)
    {
        ByteBuffer buffer1 = ByteBuffer.allocate(10);
        if (buffer1.hasArray())
```

```

    {
        System.out.println("buffer1 array: " + buffer1.array());
        System.out.println("Buffer1 array offset: " + buffer1.arrayOffset());
        System.out.println("Capacity: " + buffer1.capacity());
        System.out.println("Limit: " + buffer1.limit());
        System.out.println("Position: " + buffer1.position());
        System.out.println("Remaining: " + buffer1.remaining());
        System.out.println();
    }

    byte[] bytes = new byte[200];
    ByteBuffer buffer2 = ByteBuffer.wrap(bytes);
    buffer2 = ByteBuffer.wrap(bytes, 10, 50);
    if (buffer2.hasArray())
    {
        System.out.println("buffer2 array: " + buffer2.array());
        System.out.println("Buffer2 array offset: " + buffer2.arrayOffset());
        System.out.println("Capacity: " + buffer2.capacity());
        System.out.println("Limit: " + buffer2.limit());
        System.out.println("Position: " + buffer2.position());
        System.out.println("Remaining: " + buffer2.remaining());
    }
}
}

```

Compile Listing 13-2 (`javac BufferDemo.java`), and run this application (`java BufferDemo`). You should observe the following output:

---

```

buffer1 array: [B@15e565bd
Buffer1 array offset: 0
Capacity: 10
Limit: 10
Position: 0
Remaining: 10

buffer2 array: [B@77a6686
Buffer2 array offset: 0
Capacity: 200
Limit: 60
Position: 10
Remaining: 50

```

---

In addition to managing data elements stored in external arrays (via the `wrap()` methods), buffers can also manage data stored in other buffers. When you create a buffer that manages another buffer's data, the created buffer is known as a *view buffer*. Changes made in either buffer are reflected in the other.

View buffers are created by calling a `Buffer` subclass's `duplicate()` method. The resulting view buffer is equivalent to the original buffer; both buffers share the same data items and have equivalent capacities. However, each buffer has its own position, limit, and mark. When the buffer being duplicated is read-only or direct, the view buffer is also read-only or direct.

Consider the following example:

```
ByteBuffer buffer = ByteBuffer.allocate(10);
ByteBuffer bufferView = buffer.duplicate();
```

The `ByteBuffer` instance identified by `bufferView` shares the same internal array of 10 elements as `buffer`. At the moment, these buffers have the same position, limit, and (undefined) mark. However, these properties in one buffer can be changed independently of the properties in the other buffer.

View buffers are also created by calling one of `ByteBuffer`'s `asXBuffer()` methods. For example, `LongBuffer asLongBuffer()` returns a view buffer that conceptualizes the byte buffer as a buffer of long integers.

**Note** Read-only view buffers can be created by calling a method such as `ByteBuffer asReadOnlyBuffer()`. Any attempt to change a read-only view buffer's content results in `ReadOnlyBufferException`. However, the original buffer content (provided that it isn't read-only) can be changed, and the read-only view buffer will reflect these changes.

## Buffer Writing and Reading

`ByteBuffer` and the other primitive-type buffer classes declare several overloaded `put()` and `get()` methods for writing data items to and reading data items from a buffer. These methods are absolute when they require an index argument or relative when they don't require an index.

For example, `ByteBuffer` declares the absolute `ByteBuffer put(int index, byte b)` method to store byte `b` in the buffer at the `index` value and the absolute byte `get(int index)` method to fetch the byte located at position `index`. This class also declares the relative `ByteBuffer put(byte b)` method to store byte `b` in the buffer at the current position and then increment the current position, and the relative byte `get()` method to fetch the byte located at the buffer's current position and increment the current position.

The absolute `put()` and `get()` methods throw `IndexOutOfBoundsException` when `index` is negative or greater than or equal to the buffer's limit. The relative `put()` method throws `java.nio.BufferOverflowException` when the current position is greater than or equal to the limit, and the relative `get()` method throws `java.nio.BufferUnderflowException` when the current position is greater than or equal to the limit. Furthermore, the absolute and relative `put()` methods throw `ReadOnlyBufferException` when the buffer is read-only.

Listing 13-3 demonstrates the relative `put()` method and the absolute `get()` method.

*Listing 13-3. Writing Bytes to and Reading Them from a Buffer*

```
import java.nio.ByteBuffer;

public class BufferDemo
{
    public static void main(String[] args)
    {
        ByteBuffer buffer = ByteBuffer.allocate(7);
        System.out.println("Capacity = " + buffer.capacity());
        System.out.println("Limit = " + buffer.limit());
        System.out.println("Position = " + buffer.position());
        System.out.println("Remaining = " + buffer.remaining());

        buffer.put((byte) 10).put((byte) 20).put((byte) 30);

        System.out.println("Capacity = " + buffer.capacity());
        System.out.println("Limit = " + buffer.limit());
        System.out.println("Position = " + buffer.position());
        System.out.println("Remaining = " + buffer.remaining());

        for (int i = 0; i < buffer.position(); i++)
            System.out.println(buffer.get(i));
    }
}
```

Compile Listing 13-3 (`javac BufferDemo.java`), and run this application (`java BufferDemo`). You should observe the following output:

---

```
Capacity = 7
Limit = 7
Position = 0
Remaining = 7
Capacity = 7
Limit = 7
Position = 3
Remaining = 4
10
20
30
```

---

Figure 13-2 illustrates the state of the buffer following the three `put()` method calls and presented in the previous output.

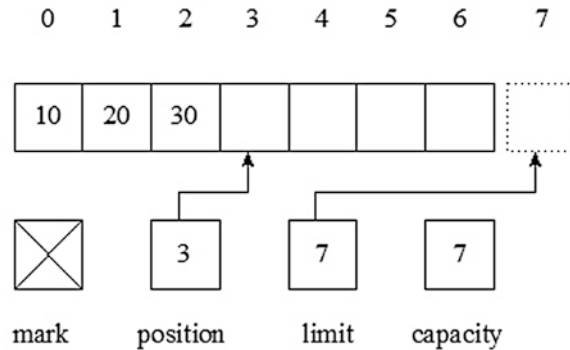

**Figure 13-2.** The buffer can store four more data items before reaching its capacity

The subsequent calls to the absolute `get()` method don't change the position, which remains set to 3.

**Tip** For maximum efficiency, you can perform bulk data transfers by using the `ByteBuffer put(byte[] src)`, `ByteBuffer put(byte[] src, int offset, int length)`, `ByteBuffer get(byte[] dst)`, and `ByteBuffer get(byte[] dst, int offset, int length)` methods to write and read an array of bytes.

## Flipping Buffers

After filling a buffer, you must prepare it for draining by a channel. When you pass the buffer as is, the channel accesses undefined data beyond the current position.

To solve this problem, you could reset the position to 0, but how would the channel know when the end of the inserted data had been reached? The solution is to work with the `limit` property, which indicates the end of the active portion of the buffer. Basically, you set the `limit` to the current position and then reset the current position to 0.

You could accomplish this task by executing the following code, which also clears any defined mark:

```
buffer.limit(buffer.position()).position(0);
```

However, there's an easier way to accomplish the same task, as shown here:

```
buffer.flip();
```

In either case, the buffer is ready to be drained.

Assuming that `buffer.flip();` is executed at the end of Listing 13-3's `main()` method, Figure 13-3 reveals what the buffer state would look like after calling `flip()`.



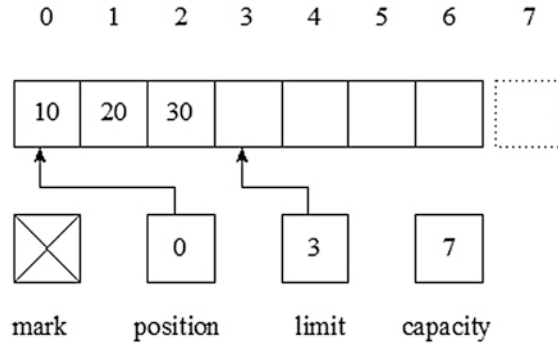

**Figure 13-3.** The buffer is ready to be drained

A call to `buffer.remaining()` would return 3. This value indicates the number of bytes available for draining (10, 20, and 30).

Listing 13-4 provides another buffer flipping demonstration, which uses a character buffer.

**Listing 13-4.** Writing Characters to and Reading Them from a Character Buffer

```
import java.nio.CharBuffer;

public class BufferDemo
{
    public static void main(String[] args)
    {
        String[] poem =
        {
            "Roses are red",
            "Violets are blue",
            "Sugar is sweet",
            "And so are you."
        };

        CharBuffer buffer = CharBuffer.allocate(50);

        for (int i = 0; i < poem.length; i++)
        {
            // Fill the buffer.
            for (int j = 0; j < poem[i].length(); j++)
                buffer.put(poem[i].charAt(j));

            // Flip the buffer so that its contents can be read.
            buffer.flip();

            // Drain the buffer.
            while (buffer.hasRemaining())
                System.out.print(buffer.get());
        }
    }
}
```

```

    // Empty the buffer to prevent BufferOverflowException.
    buffer.clear();

    System.out.println();
  }
}

```

Compile Listing 13-4 (`javac BufferDemo.java`), and run this application (`java BufferDemo`). You should observe the following output:

```

Roses are red
Violets are blue
Sugar is sweet
And so are you.

```

**Note** `rewind()` is similar to `flip()` but ignores the limit. Also, calling `flip()` twice doesn't return you to the original state. Instead, the buffer has a zero size. Calling a `put()` method results in `BufferOverflowException`, and calling a `get()` method results in `BufferUnderflowException` or (in the case of `get(int)`), `IndexOutOfBoundsException`.

## Marking Buffers

You can mark a buffer by invoking the `mark()` method and later return to the marked position by invoking `reset()`. For example, suppose you've executed `ByteBuffer buffer = ByteBuffer.allocate(7);`, followed by `buffer.put((byte) 10).put((byte) 20).put((byte) 30).put((byte) 40);`, followed by `buffer.limit(4);`. The current position and limit are set to 4.

Continuing, suppose you execute `buffer.position(1).mark().position(3);`. Figure 13-4 reveals the buffer state at this point.

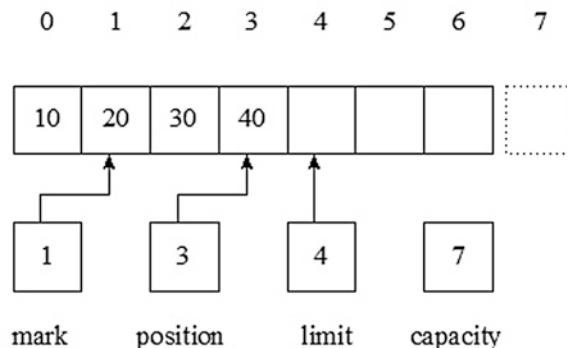

Figure 13-4. The mark has been set to position 1

If you sent this buffer to a channel, byte 40 would be sent (the current position is 3 because of `position(3)`) and the position would advance to 4. If you subsequently executed `buffer.reset()`; and sent this buffer to the channel, the position would be set to the mark (1) and bytes 20, 30, and 40 (all bytes from the current position to one position below the limit) would be sent to the channel (and in that order).

Listing 13-5 demonstrates this mark/reset scenario.

*Listing 13-5. Marking the Current Buffer Position and Resetting the Current Position to the Marked Position*

```
import java.nio.ByteBuffer;

public class BufferDemo
{
    public static void main(String[] args)
    {
        ByteBuffer buffer = ByteBuffer.allocate(7);
        buffer.put((byte) 10).put((byte) 20).put((byte) 30).put((byte) 40);
        buffer.limit(4);
        buffer.position(1).mark().position(3);
        System.out.println(buffer.get());
        System.out.println();
        buffer.reset();
        while (buffer.hasRemaining())
            System.out.println(buffer.get());
    }
}
```

Compile Listing 13-5 (`javac BufferDemo.java`), and run this application (`java BufferDemo`). You should observe the following output:

---

```
40
20
30
40
```

---

**Caution** Don't confuse `reset()` with `clear()`. The `clear()` method marks a buffer as empty whereas `reset()` changes the buffer's current position to the previously set mark, or throws `InvalidMarkException` when there's no previously set mark.

## Buffer Subclass Operations

`ByteBuffer` and the other primitive-type buffer classes declare a `compact()` method that's useful for compacting a buffer by copying all bytes between the current position and the limit to the beginning of the buffer. The byte at index  $p = \text{position}()$  is copied to index 0, the byte at index  $p + 1$  is copied to index 1, and so on until the byte at index  $\text{limit}() - 1$  is copied to index  $n = \text{limit}() - 1 - p$ . The buffer's current position is then set to  $n + 1$  and its limit is set to its capacity. The mark, when defined, is discarded.

You invoke `compact()` after writing data from a buffer to handle situations where not all of the buffer's content is written. Consider the following example that copies content from an `in` channel to an `out` channel via buffer `buf`:

```
buf.clear(); // Prepare buffer for use
while (in.read(buf) != -1)
{
    buf.flip(); // Prepare buffer for draining.
    out.write(buf); // Write the buffer.
    buf.compact(); // Do this in case of a partial write.
}
```

The `compact()` method call moves unwritten buffer data to the beginning of the buffer so that the next `read()` method call appends read data to the buffer's data instead of overwriting that data when `compact()` isn't specified.

You may occasionally need to compare buffers for equality or order. All `Buffer` subclasses except for `ByteBuffer`'s `MappedByteBuffer` subclass override the `equals()` and `compareTo()` methods to perform these comparisons—`MappedByteBuffer` inherits these methods from its `ByteBuffer` superclass. The following example shows you how to compare byte buffers `bytBuf1` and `bytBuf2` for equality and ordering:

```
System.out.println(bytBuf1.equals(bytBuf2));
System.out.println(bytBuf1.compareTo(bytBuf2));
```

The `equals()` contract for `ByteBuffer` states that 2 byte buffers are equal if and only if they have the same element type; they have the same number of remaining elements; and the two sequences of remaining elements, considered independently of their starting positions, are individually equal. This contract is the same for the other `Buffer` subclasses.

The `compareTo()` method for `ByteBuffer` states that 2 byte buffers are compared for order by comparing their sequences of remaining elements lexicographically, without regard to the starting position of each sequence within its corresponding buffer. Pairs of byte elements are compared as if by invoking `Byte.compare(byte, byte)`. Similar descriptions apply to the other `Buffer` subclasses.

## Byte Ordering

Nonbyte primitive types, except for `Boolean` (which might be represented by a bit or by a byte), are composed of several bytes: a character or a short integer occupies 2 bytes, a 32-bit integer or a floating-point value occupies 4 bytes, and a long integer or a double precision floating-point value occupies 8 bytes. Each value of one of these multibyte types is stored in a sequence of contiguous memory locations. However, the order of these bytes can differ from platform to platform.

For example, consider 32-bit long integer 0x10203040. This value's 4 bytes could be stored in memory (from low address to high address) as 10, 20, 30, 40; this arrangement is known as *big-endian order* (the most significant byte, the "big" end, is stored at the lowest address). Alternatively, these bytes could be stored as 40, 30, 20, 10; this arrangement is known as *little-endian order* (the least significant byte, the "little" end, is stored at the lowest address).

Java provides the `java.nio.ByteOrder` class to help you deal with byte-order issues when writing/reading multibyte values to/from a multibyte buffer. `ByteOrder` declares a `ByteOrder nativeOrder()` method that returns the platform's byte order as a `ByteOrder` instance. Because this instance is one of `ByteOrder`'s `BIG_ENDIAN` and `LITTLE_ENDIAN` constants, and because no other `ByteOrder` instances can be created, you can compare `nativeOrder()`'s return value to one of these constants via the `==` or `!=` operator.

Also, each multibyte class (such as `FloatBuffer`) declares a `ByteOrder order()` method that returns the buffer's byte order. This method returns `ByteOrder.BIG_ENDIAN` or `ByteOrder.LITTLE_ENDIAN`.

The `ByteOrder` value returned from `order()` can take on a different value based on how the buffer was created. If a multibyte buffer (such as a float buffer) was created by allocation or by wrapping an existing array, the buffer's byte order is the native order of the underlying platform. However, if a multibyte buffer was created as a view of a byte buffer, the view buffer's byte order is that of the byte buffer when the view was created. The view buffer's byte order cannot be subsequently changed.

`ByteBuffer` differs from the multibyte classes when it comes to byte order. Its default byte order is always big endian, even when the underlying platform's byte order is little endian. `ByteBuffer` defaults to big endian because Java's default byte order is also big endian, which lets classfiles and serialized objects store data consistently across virtual machines.

Because this big endian default can impact performance on little-endian platforms, `ByteBuffer` also declares a `ByteBuffer order(ByteOrder bo)` method to change the byte buffer's byte order.

Although it may seem unusual to change the byte order of a byte buffer (where only single-byte data items are accessed), this method is useful because `ByteBuffer` also declares several convenience methods for writing and reading multibyte values (`ByteBuffer putInt(int value)` and `int getInt()`, for example). These convenience methods write these values according to the byte buffer's current byte order. Furthermore, you can subsequently call `ByteBuffer`'s `LongBuffer asLongBuffer()` or another `asXBuffer()` method to return a view buffer whose order will reflect the byte buffer's changed byte order.

## Direct Byte Buffers

Unlike multibyte buffers, byte buffers can serve as the sources and/or targets of channel-based I/O. This shouldn't come as a surprise because operating systems perform I/O on memory areas that are contiguous sequences of 8-bit bytes (not floating-point values, not 32-bit integers, and so on).

Operating systems can directly access the address space of a process. For example, an operating system could directly access a virtual machine process's address space to perform a data transfer operation based on a byte array. However, a virtual machine might not store the array of bytes contiguously or its garbage collector might move the byte array to another location. Because of these limitations, direct byte buffers were created.

A *direct byte buffer* is a byte buffer that interacts with channels and native code to perform I/O. The direct byte buffer attempts to store byte elements in a memory area that a channel uses to perform *direct* (raw) access via native code that tells the operating system to drain or fill the memory area directly.

Direct byte buffers are the most efficient means for performing I/O on the virtual machine. Although you can also pass nondirect byte buffers to channels, a performance problem might arise because nondirect byte buffers are not always able to serve as the target of native I/O operations.

When passed a nondirect byte buffer, a channel might have to create a temporary direct byte buffer, copy the nondirect byte buffer's content to the direct byte buffer, perform the I/O operation on the temporary direct byte buffer, and copy the temporary direct byte buffer's content to the nondirect byte buffer. The temporary direct byte buffer will then be subject to garbage collection.

Although optimal for I/O, a direct byte buffer can be expensive to create because memory extraneous to the virtual machine's heap will need to be allocated by the operating system, and setting up/tearing down this memory might take longer than when the buffer was located within the heap. After your code is working and should you want to experiment with performance optimization, you can easily obtain a direct byte buffer by invoking `ByteBuffer`'s `allocateDirect()` method, which I discussed earlier.

## Working with Channels

Channels partner with buffers to achieve high-performance I/O. A *channel* is an object that represents an open connection to a hardware device, a file, a network socket, an application component, or another entity that's capable of performing write, read, and other I/O operations. Channels efficiently transfer data between byte buffers and I/O service sources or destinations.

**Note** Channels are the gateways through which native I/O services are accessed. Channels use byte buffers as the endpoints for sending and receiving data.

There often exists a one-to-one correspondence between an operating system file handle or file descriptor and a channel. When you work with channels in a file context, the channel will often be connected to an open file descriptor. Despite channels being more abstract than file descriptors, they are still capable of modeling an operating system's native I/O facilities.

## Channel and Its Children

Java supports channels via its `java.nio.channels` and `java.nio.channels.spi` packages. Applications interact with the types located in the former package; developers who are defining new selector providers work with the latter package. (I will discuss selectors later in this chapter.)

All channels are instances of classes that ultimately implement the `java.nio.channels.Channel` interface. `Channel` declares the following methods:

- `void close()`: Closes this channel. When this channel is already closed, invoking `close()` has no effect. When another thread has already invoked `close()`, a new `close()` invocation blocks until the first invocation finishes, after which `close()` returns without effect. This method throws `IOException` when an I/O error occurs. After the channel is closed, any further attempts to invoke I/O operations upon it result in `java.nio.channels.ClosedChannelException` being thrown.
- `boolean isOpen()`: Returns this channel's open status. This method returns `true` when the channel is open; otherwise, it returns `false`.

These methods indicate that only two operations are common to all channels: close the channel and determine whether the channel is open or closed. To support I/O, `Channel` is extended by the `java.nio.channels.WritableByteChannel` and `java.nio.channels.ReadableByteChannel` interfaces:

- `WritableByteChannel` declares an abstract `int write(ByteBuffer buffer)` method that writes a sequence of bytes from `buffer` to the current channel. This method returns the number of bytes actually written. It throws `java.nio.channels.NonWritableChannelException` when the channel was not opened for writing, `java.nio.channels.ClosedChannelException` when the channel is closed, `java.nio.channels.AsynchronousCloseException` when another thread closes the channel during the write, `java.nio.channels.ClosedByInterruptException` when another thread interrupts the current thread while the write operation is in progress (thereby closing the channel and setting the current thread's interrupt status), and `java.io.IOException` when some other I/O error occurs.
- `ReadableByteChannel` declares an abstract `int read(ByteBuffer buffer)` method that reads bytes from the current channel into `buffer`. This method returns the number of bytes actually read (or `-1` when there are no more bytes to read). It throws `java.nio.channels.NonReadableChannelException` when the channel was not opened for reading; `ClosedChannelException` when the channel is closed; `AsynchronousCloseException` when another thread closes the channel during the read; `ClosedByInterruptException` when another thread interrupts the current thread while the write operation is in progress, thereby closing the channel and setting the current thread's interrupt status; and `IOException` when some other I/O error occurs.

**Note** A channel whose class implements only `WritableByteChannel` or `ReadableByteChannel` is *unidirectional*. Attempting to read from a writable byte channel or write to a readable byte channel results in a thrown exception.

You can use the `instanceof` operator to determine if a channel instance implements either interface. Because it's somewhat awkward to test for both interfaces, Java supplies the `java.nio.channels.ByteChannel` interface, which is an empty marker interface that subtypes `WritableByteChannel` and `ReadableByteChannel`. When you need to learn whether or not a channel is *bidirectional*, it's more convenient to specify an expression such as `channel instanceof ByteChannel`.

`Channel` is also extended by the `java.nio.channels.InterruptibleChannel` interface. `InterruptibleChannel` describes a channel that can be asynchronously closed and interrupted. This interface overrides its `Channel` superinterface's `close()` method header, presenting the following additional stipulation to `Channel`'s contract for this method: any thread currently blocked in an I/O operation upon this channel will receive `AsynchronousCloseException` (an `IOException` descendent).

A channel that implements this interface is asynchronously *closeable*: When a thread is blocked in an I/O operation on an interruptible channel, another thread may invoke the channel's `close()` method. This causes the blocked thread to receive a thrown `AsynchronousCloseException` instance.

A channel that implements this interface is also *interruptible*: when a thread is blocked in an I/O operation on an interruptible channel, another thread may invoke the blocked thread's `interrupt()` method. Doing this causes the channel to be closed, the blocked thread to receive a thrown `ClosedByInterruptException` instance, and the blocked thread to have its interrupt status set. (When a thread's interrupt status is already set and it invokes a blocking I/O operation on a channel, the channel is closed and the thread will immediately receive a thrown `ClosedByInterruptException` instance; its interrupt status will remain set.)

NIO's designers chose to shut down a channel when a blocked thread is interrupted because they couldn't find a way to handle interrupted I/O operations reliably in the same manner across platforms. The only way to guarantee deterministic behavior was to shut down the channel.

**Tip** You can determine whether or not a channel supports asynchronous closing and interruption by using the `instanceof` operator in an expression such as `channel instanceof InterruptibleChannel`.



You previously learned that you must call a class method on a Buffer subclass to obtain a buffer. Regarding channels, there are two ways to obtain a channel:

- The `java.nio.channels` package provides a `Channels` utility class that offers two methods for obtaining channels from streams—for each of the following methods, the underlying stream is closed when the channel is closed, and the channel isn't buffered:
  - `WritableByteChannel newChannel(OutputStream outputStream)` returns a writable byte channel for the given `outputStream`.
  - `ReadableByteChannel newChannel(InputStream inputStream)` returns a readable byte channel for the given `inputStream`.
- Various classic I/O classes have been retrofitted to support channel creation. For example, `RandomAccessFile` declares a `FileChannel getChannel()` method for returning a file channel instance, and `java.net.Socket` declares a `SocketChannel getChannel()` method for returning a socket channel.

Listing 13-6 uses the `Channels` class to obtain channels for the standard input and output streams and then uses these channels to copy bytes from the input channel to the output channel.

*Listing 13-6. Copying Bytes from an Input Channel to an Output Channel*

```
import java.io.IOException;

import java.nio.ByteBuffer;

import java.nio.channels.Channels;
import java.nio.channels.ReadableByteChannel;
import java.nio.channels.WritableByteChannel;

public class ChannelDemo
{
    public static void main(String[] args)
    {
        ReadableByteChannel src = Channels.newChannel(System.in);
        WritableByteChannel dest = Channels.newChannel(System.out);

        try
        {
            copy(src, dest); // or copyAlt(src, dest);
        }
        catch (IOException ioe)
        {
            System.err.println("I/O error: " + ioe.getMessage());
        }
        finally
        {
            try
            {
                src.close();
                dest.close();
            }
        }
    }
}
```

```

        catch (IOException ioe)
        {
            ioe.printStackTrace();
        }
    }
}

static void copy(ReadableByteChannel src, WritableByteChannel dest)
    throws IOException
{
    ByteBuffer buffer = ByteBuffer.allocateDirect(2048);
    while (src.read(buffer) != -1)
    {
        buffer.flip();
        dest.write(buffer);
        buffer.compact();
    }
    buffer.flip();
    while (buffer.hasRemaining())
        dest.write(buffer);
}

static void copyAlt(ReadableByteChannel src, WritableByteChannel dest)
    throws IOException
{
    ByteBuffer buffer = ByteBuffer.allocateDirect(2048);
    while (src.read(buffer) != -1)
    {
        buffer.flip();
        while (buffer.hasRemaining())
            dest.write(buffer);
        buffer.clear();
    }
}
}

```

Listing 13-6 presents two approaches to copying bytes from the standard input stream to the standard output stream. In the first approach, which is exemplified by the `copy()` method, the goal is to minimize native I/O calls (via the `write()` method calls), although more data may end up being copied as a result of the `compact()` method calls. In the second approach, as demonstrated by `copyAlt()`, the goal is to eliminate data copying, although more native I/O calls might occur.

Each of `copy()` and `copyAlt()` first allocates a direct byte buffer (recall that a direct byte buffer is the most efficient means for performing I/O on the virtual machine) and enters a while loop that continually reads bytes from the source channel until end-of-input (`read()` returns -1). Following the read, the buffer is flipped so that it can be drained. Here is where the methods diverge.

- The `copy()` method while loop makes a single call to `write()`. Because `write()` might not completely drain the buffer, `compact()` is called to compact the buffer before the next read. Compaction ensures that unwritten buffer content isn't overwritten during the next read operation. Following the while loop, `copy()` flips the buffer in preparation for draining any remaining content and then works with `hasRemaining()` and `write()` to drain the buffer completely.
- The `copyAlt()` method while loop contains a nested while loop that works with `hasRemaining()` and `write()` to continue draining the buffer until the buffer is empty. This is followed by a `clear()` method call that empties the buffer so that it can be filled on the next `read()` call.

**Note** It's important to realize that a single `write()` method call may not output the entire content of a buffer. Similarly, a single `read()` call may not completely fill a buffer.

Compile Listing 13-6 via the following command line:

```
javac ChannelDemo.java
```

Run `ChannelDemo` via the following command lines:

```
java ChannelDemo  
java ChannelDemo <ChannelDemo.java >ChannelDemo.bak
```

The first command line copies standard input to standard output. The second command line copies the contents of `ChannelDemo.java` to `ChannelDemo.bak`. After testing the `copy()` method, replace `copy(src, dest);` with `copyAlt(src, dest);` and repeat.

## Channels in Depth

The previous discussion of the `Channel` interface and its direct descendents has given you some insight into NIO channels. However, there's much more to explore. This section takes you deeper into channels by exploring scatter/gather I/O, file channels, socket channels, and pipes.

### Scatter/Gather I/O

Channels provide the ability to perform a single I/O operation across multiple buffers. This capability is known as *scatter/gather I/O* (and is also known as *vectored I/O*).

In the context of a write operation, the contents of several buffers are *gathered* (drained) in sequence and then sent through the channel to a destination; these buffers are not required to have identical capacities. In the context of a read operation, the contents of a channel are *scattered* (filled) to multiple buffers in sequence; each buffer is filled to its limit until the channel is empty or total buffer space is used up.

**Note** Modern operating systems provide APIs that support vectored I/O to eliminate (or at least reduce) system calls or buffer copies, and hence improve performance. For example, the Win32/Win64 APIs provide `ReadFileScatter()` and `WriteFileGather()` functions for this purpose.

Java provides the `java.nio.channels.ScatteringByteChannel` interface to support scattering and the `java.nio.channels.GatheringByteChannel` interface to support gathering.

`ScatteringByteChannel` offers the following methods:

- `long read(ByteBuffer[] buffers, int offset, int length)`
- `long read(ByteBuffer[] buffers)`

`GatheringByteChannel` offers the following methods:

- `long write(ByteBuffer[] buffers, int offset, int length)`
- `long write(ByteBuffer[] buffers)`

The first `read()` method and the first `write()` method let you identify the first buffer to read/write by passing a zero-based offset to `offset`, and the number of buffers to read/write by passing a value to `length`. The second `read()` method and the second `write()` method read and write all buffers in sequence.

Listing 13-7 demonstrates `read(ByteBuffer[] buffers)` and `write(ByteBuffer[] buffers)`.

*Listing 13-7. Demonstrating Scatter/Gather*

```
import java.io.FileInputStream;
import java.io.FileOutputStream;
import java.io.IOException;

import java.nio.ByteBuffer;

import java.nio.channels.Channels;
import java.nio.channels.GatheringByteChannel;
import java.nio.channels.ReadableByteChannel;
import java.nio.channels.ScatteringByteChannel;

public class ChannelDemo
{
    public static void main(String[] args) throws IOException
    {
        ScatteringByteChannel src;
        src = (ScatteringByteChannel) Channels.newChannel(new FileInputStream("x.dat"));
        ByteBuffer buffer1 = ByteBuffer.allocateDirect(5);
        ByteBuffer buffer2 = ByteBuffer.allocateDirect(3);
        ByteBuffer[] buffers = { buffer1, buffer2 };
        src.read(buffers);
        buffer1.flip();
    }
}
```

```

while (buffer1.hasRemaining())
    System.out.println(buffer1.get());
System.out.println();
buffer2.flip();
while (buffer2.hasRemaining())
    System.out.println(buffer2.get());
buffer1.rewind();
buffer2.rewind();
GatheringByteChannel dest;
dest = (GatheringByteChannel) Channels.newChannel(new FileOutputStream("y.dat"));
buffers[0] = buffer2;
buffers[1] = buffer1;
dest.write(buffers);
    }
}

```

Listing 13-7's `main()` method first obtains a scattering byte channel by instantiating `java.io.FileInputStream` and passing this instance to the `Channels` class's `ReadableByteChannel newChannel(InputStream inputStream)` method. The returned `ReadableByteChannel` instance is cast to `ScatteringByteChannel` because this instance is actually a file channel (discussed later) that implements `ScatteringByteChannel`.

Next, `main()` creates a couple of direct byte buffers; the first buffer has a capacity of 5 bytes and the second buffer has a capacity of 3 bytes. These buffers are subsequently stored in an array, and this array is passed to `read(ByteBuffer[])` to fill them.

After filling the buffers, `main()` flips them so that it can output their contents to standard output. After these contents have been output, the buffers are rewound in preparation for being drained via a gather operation.

`main()` now obtains a gathering byte channel by instantiating `java.io.FileOutputStream` and passing this instance to the `Channels` class's `WritableByteChannel newChannel(OutputStream outputStream)` method. The returned `WritableByteChannel` instance is cast to `GatheringByteChannel` because this instance is actually a file channel (discussed later) that implements `GatheringByteChannel`.

Finally, `main()` assigns these buffers to the `buffers` array in reverse order to how they were originally assigned, and then passes this array to `write(ByteBuffer[])` to drain them.

Create a file named `x.dat`, and store the following text in this file:

```
12345abcdefg
```

Now compile Listing 13-7 (`javac ChannelDemo.java`), and run this application (`java ChannelDemo`). You should observe the following Unicode values for the first eight characters:

```
49
50
51
52
53

97
98
99
```

Additionally, you should observe a newly created `y.dat` file with the following content:

```
abc12345
```

## File Channels

I previously mentioned that `RandomAccessFile` declares a `FileChannel getChannel()` method for returning a file channel instance, which describes an open connection to a file. It turns out that `FileInputStream` and `FileOutputStream` also provide the same method. In contrast, `FileReader` and `FileWriter` don't offer a way to obtain a file channel.

**Caution** The file channel returned from `FileInputStream`'s `getChannel()` method is read-only, and the file channel returned from `FileOutputStream`'s `getChannel()` method is write-only. Attempting to write to a read-only file channel or read from a write-only file channel results in an exception.

The abstract `java.nio.channels.FileChannel` class describes a file channel. Because this class implements the `InterruptibleChannel` interface, file channels are interruptible. Because this class implements the `ByteChannel`, `GatheringByteChannel`, and `ScatteringByteChannel` interfaces, you can write to, read from, and perform scattering I/O on underlying files. However, there's more.

**Note** Unlike buffers, which are not thread-safe, file channels are thread-safe.

A file channel maintains a current position into the file, which `FileChannel` lets you obtain and change. It also lets you request that cached data be forced to the disk, read/write file content, obtain the size of the file underlying the channel, truncate a file, attempt to lock the entire file or just a region of the file, perform memory-mapped file I/O, and transfer data directly to another channel in a manner that has the potential to be optimized by the platform.

Table 13-2 describes a few of `FileChannel`'s methods.

Table 13-2. FileChannel Methods

Method	Description
<code>void force(boolean metadata)</code>	<p>Requests that all updates to this file channel be committed to the storage device. When this method returns, all modifications made to the platform file underlying this channel have been committed when the file resides on a local storage device. However, when the file isn't hosted locally (it's on a networked file system, for example), applications cannot be certain that the modifications have been committed. (No assurances are given that changes made to the file using methods defined elsewhere will be committed. For example, changes made via a mapped byte buffer may not be committed.)</p> <p>The <code>metadata</code> value indicates whether the update should include the file's metadata (such as last modification time and last access time), when <code>true</code> is passed, or not include the file's metadata, when <code>false</code> is passed. Passing <code>true</code> may invoke an underlying write to the operating system (if the platform is maintaining metadata, such as last access time), even when the channel is opened as a read-only channel.</p> <p>This method throws <code>ClosedChannelException</code> when the channel is already closed and throws <code>IOException</code> when any other I/O error occurs.</p>
<code>long position()</code>	<p>Returns the current zero-based file position maintained by this file channel. This method throws <code>ClosedChannelException</code> when the file channel is closed and <code>IOException</code> when another I/O error occurs.</p>
<code>FileChannel position(long newPosition)</code>	<p>Sets this file channel's current file position to <code>newPosition</code>. The argument is the number of bytes counted from the start of the file. The position cannot be set to a negative value. However, it can be set beyond the current file size. If set beyond the current file size, attempts to read will return end of file. Write operations will succeed, but they will fill the bytes between the current end of file and the new position with the required number of (unspecified) byte values. This method throws <code>IllegalArgumentException</code> when <code>offset</code> is negative, <code>ClosedChannelException</code> when the file channel is closed, and <code>IOException</code> when another I/O error occurs.</p>
<code>int read(ByteBuffer buffer)</code>	<p>Reads bytes from this file channel into the given buffer. The maximum number of bytes that will be read is the remaining number of bytes in the buffer when the method is invoked. The bytes will be copied into the buffer starting at the buffer's current position. The call may block when other threads are also attempting to read from this channel. Upon completion, the buffer's position is set to the end of the bytes that have been read. The buffer's limit isn't changed. This method returns the number of bytes actually read and throws the same exceptions as previously discussed regarding <code>ReadableByteChannel</code>.</p>

(continued)

**Table 13-2.** (continued)

Method	Description
<code>int read(ByteBuffer dst, long position)</code>	Equivalent to the previous method except that bytes are read starting at the specified file position. <code>IllegalArgumentException</code> is thrown when position is negative.
<code>long size()</code>	Returns the size (in bytes) of the file underlying this file channel. This method throws <code>ClosedChannelException</code> when the file channel is closed and <code>IOException</code> when another I/O error occurs.
<code>FileChannel truncate(long size)</code>	Truncates the file underlying this file channel to size. Any bytes beyond the given size are removed from the file. When there are no bytes beyond the given size, the file contents are unmodified. When the current file position is greater than the given size, it's set to size.
<code>int write(ByteBuffer buffer)</code>	Writes a sequence of bytes to this file channel from the given buffer. Bytes are written starting at the channel's current file position unless the channel is in append mode, in which case the position is first advanced to the end of the file. The file is grown (when necessary) to accommodate the written bytes, and then the file position is updated with the number of bytes actually written. Otherwise, this method behaves exactly as specified by the <code>WritableByteChannel</code> interface. This method returns the number of bytes actually written and throws the same exceptions as previously discussed regarding <code>WritableByteChannel</code> .
<code>int write(ByteBuffer src, long position)</code>	Equivalent to the previous method except that bytes are written starting at the specified file position. <code>IllegalArgumentException</code> is thrown when position is negative.

The `force()` method ensures that all changes made to a file residing in the local filesystem, and since this method was previously invoked, are written to the disk. This capability is vital for critical tasks such as transaction processing where you must maintain data integrity and ensure reliable recovery. However, this guarantee doesn't apply to remote filesystems.

Passing `true` to `force()` results in metadata (last modification time, access permissions, and so on) also being synchronized to the disk. Because metadata isn't usually critical to file recovery, you can often pass `false` and gain a small performance increase because an extra I/O operation isn't required to output the metadata.

`FileChannel` objects support the concept of a current file position, which determines the location where the next data item will be read from or written to. The `position()` method returns the current position, and the `position(long newPosition)` method sets the current position to `newPosition`. The value passed to `newPosition` must be nonnegative or `IllegalArgumentException` will be thrown.

There are two forms of the `read()` and `write()` methods. The relative forms don't take position arguments, and they ensure that the current file position is updated after a call to either method. The absolute forms of these methods take a position argument and don't update the position. Absolute reads and writes can be more efficient because the channel's state doesn't need to be updated.



If you attempt to perform an absolute read past the end of a file, which `size()` returns, `-1` is returned to signify end of file. Attempting to perform an absolute write past the end of a file causes the file to grow to accommodate the bytes being written. The values of the bytes located between the previous end of file and the first newly written byte are filesystem-specific and may constitute a hole.

A *hole* occurs in a file when the amount of disk space allocated for the file is smaller than the file's size. Modern filesystems typically allocate space only for data that's written to the file. When data is written to noncontiguous areas, holes can appear. When the file is read, holes typically appear to be zero-filled but don't take up disk space.

The `truncate(long size)` method is useful for reducing a file's size. This method truncates all data beyond the specified size. When the file's size is greater than the specified size, all bytes past the specified size are discarded. When the specified size is greater than or equal to the current size, the file isn't changed.

Listing 13-8 demonstrates various methods from Table 13-2.

*Listing 13-8. Demonstrating a File Channel*

```
import java.io.IOException;
import java.io.RandomAccessFile;

import java.nio.ByteBuffer;

import java.nio.channels.FileChannel;

public class ChannelDemo
{
    public static void main(String[] args) throws IOException
    {
        RandomAccessFile raf = new RandomAccessFile("temp", "rw");
        FileChannel fc = raf.getChannel();
        long pos;
        System.out.println("Position = " + (pos = fc.position()));
        System.out.println("size: " + fc.size());
        String msg = "This is a test message.";
        ByteBuffer buffer = ByteBuffer.allocateDirect(msg.length() * 2);
        buffer.asCharBuffer().put(msg);
        fc.write(buffer);
        fc.force(true);
        System.out.println("position: " + fc.position());
        System.out.println("size: " + fc.size());
        buffer.clear();
        fc.position(pos);
        fc.read(buffer);
        buffer.flip();
        while (buffer.hasRemaining())
            System.out.print(buffer.getChar());
    }
}
```

Listing 13-8's `main()` method first creates a randomly-accessible file named `temp` for writing and reading. It then obtains a channel for communicating with this file and reports the file channel's current position and the file's size, which are both 0 for a newly created file.

`main()` next allocates a direct byte buffer for storing a message to be written to the file, treats this buffer as a character buffer, and calls the character buffer's `put()` method to store the message in the buffer, which is then output to the file.

`main()` now calls `force(true)` to recommend to the underlying operating system that the data be committed to the underlying storage device.

After reporting the new current position and file size, `main()` clears the buffer, resets the current file position to the position that was current before the message was written, and reads the previously written content back into the buffer. It then flips the buffer and outputs its contents.

Compile Listing 13-8 (`javac ChannelDemo.java`), and run this application (`java ChannelDemo`). You should observe the following output:

---

```
Position = 0
size: 46
position: 46
size: 46
This is a test message.
```

---

## Locking Files

The ability to lock all or part of a file was an important but missing feature in Java until Java 1.4 arrived. This capability lets a virtual machine process prevent other processes from accessing all or part of a file until it's finished with the entire file or part of the file.

**Note** Think of a *process* as an executing application, such as the `java` command which loads and starts running the Java virtual machine.

Although an entire file can be locked, it's often desirable to lock a smaller region. For example, a database management system might lock individual table rows that are being updated instead of locking the entire table so that read requests can be honored, which improves throughput.

Locks that are associated with files are known as *file locks*. Each file lock starts at a certain byte position in the file and has a specific length (in bytes) from this position. Together, they define the region governed by the lock. File locks let processes coordinate access to various regions in a file.

There are two kinds of file locks: exclusive and shared. An *exclusive lock* prevents other file locks from being used within the region governed by the exclusive lock. In contrast, a *shared lock* may apply to a region governed by other shared locks.

Exclusive and shared locks are commonly used in scenarios where a shared file is primarily read and occasionally updated. A process that needs to read from the file acquires a shared lock to the entire

file or to the desired subregion. A second process that also needs to read from the file acquires a shared lock to the desired region. Both processes can read the file without interfering with each other.

Suppose a third process wants to perform updates. To do so, it would request an exclusive lock. The process would block until all exclusive or shared locks that overlap with its region were released. Once the exclusive lock was granted to the updater process, any reader process requesting a shared lock would block until the exclusive lock was released. The updater process could then update the file without the reader processes observing inconsistent data.

There are a couple more items to keep in mind regarding file locking:

- When an operating system doesn't support shared locks, a shared lock request is quietly promoted to a request for an exclusive lock. Although correctness is assured, performance may be impacted.
- Locks are applied on a per-file basis. They are not applied on a per-thread or per-process basis. Two threads running on the same virtual machine that request an exclusive lock to the same region will be granted access.

`FileChannel` declares four methods for obtaining exclusive and shared locks:

- `FileLock lock()`: Obtains an exclusive lock on this file channel's underlying file. This convenience method is equivalent to executing `fileChannel.lock(0L, Long.MAX_VALUE, false)`; where `fileChannel` references a file channel.
- This method returns a `java.nio.channels.FileLock` object representing the locked area. It throws `ClosedChannelException` when the file channel is closed; `NonWritableChannelException` when the channel isn't open for writing; `java.nio.channels.OverlappingFileLockException` when either a lock is already held that overlaps this lock request or another thread is waiting to acquire a lock that will overlap with this request; `java.nio.channels.FileLockInterruptedException` when the calling thread was interrupted while waiting to acquire the lock; `AsynchronousCloseException` when the channel was closed while the calling thread was waiting to acquire the lock; and `IOException` when some other I/O error occurs while obtaining the requested lock.
- `FileLock lock(long position, long size, boolean shared)`: This method is similar to the previous method except that it attempts to acquire a lock on the given region of this channel's file. Pass nonnegative values to `position` and `size` to delimit the region. Pass `true` to `shared` to request a shared lock and `false` to `shared` to request an exclusive lock.
- `FileLock tryLock()`: Attempts to obtain an exclusive lock on this file channel's underlying file without blocking. This convenience method is equivalent to executing `fileChannel.tryLock(0L, Long.MAX_VALUE, false)`; where `fileChannel` references a file channel.

This method returns a `FileLock` object representing the locked area or null when the lock would overlap with an existing exclusive lock in another operating system process. It throws `ClosedChannelException` when the file channel is closed; `OverlappingFileLockException` when a lock that overlaps the requested region is

already held by this virtual machine, or when another thread is already blocked in this method and is attempting to lock an overlapping region; and `IOException` when some other I/O error occurs while obtaining the requested lock.

- `FileLock tryLock(long position, long size, boolean shared)`: This method is similar to the previous method except that it attempts to acquire a lock on the given region of this channel's file. Pass nonnegative values to `position` and `size` to delimit the region. Pass `true` to `shared` to request a shared lock and `false` to `shared` to request an exclusive lock.

The `lock()` methods block when the desired region to be locked is already locked (unless both locks are shared locks). In contrast, the `tryLock()` methods return immediately with a null value.

Each method returns a `FileLock` instance, which encapsulates a locked region in the file. `FileLock`'s methods are as follows:

- `FileChannel channel()`: Returns the file channel on whose file this lock was acquired or null when the lock wasn't acquired by a file channel.
- `void close()`: Invokes the `release()` method to release the lock.
- `boolean isShared()`: Returns true to identify the lock as a shared lock or false to identify the lock as an exclusive lock.
- `boolean isValid()`: Returns true to identify a valid lock; otherwise, returns false. A lock is valid until it's released or the associated file channel is closed, whichever comes first.
- `boolean overlaps(long position, long size)`: Indicates whether (return true) or not (return false) this lock's region overlaps the region described in the parameter list.
- `long position()`: Returns the position within the file of the first byte of the locked region. A locked region doesn't need to be contained within or even overlap the underlying file, so the value returned by this method may exceed the file's current size.
- `void release()`: Releases this lock. If this lock object is valid, invoking this method releases the lock and renders the object invalid. If this lock object is invalid, invoking this method has no effect.
- `long size()`: Returns the length of the file lock (in bytes).
- `String toString()`: Returns a string describing the range, type, and validity of this lock.

A `FileLock` instance is associated with a `FileChannel` instance but the file lock represented by the `FileLock` instance associates with the underlying file and not with the file channel. Without care, you can run into conflicts (and possibly even a deadlock) when you don't release a file lock after you're

finished using it. To avoid these problems, you should adopt a pattern such as the following one in order to ensure that the file lock is always released:

```
FileLock lock = fileChannel.lock();
try
{
    // interact with the file channel
}
catch (IOException ioe)
{
    // handle the exception
}
finally
{
    lock.release();
}
```

I've created an application that demonstrates file locking. It follows this pattern to ensure that the lock is released. Listing 13-9 presents its source code.

*Listing 13-9. Demonstrating File Locking*

```
import java.io.IOException;
import java.io.RandomAccessFile;

import java.nio.ByteBuffer;
import java.nio.IntBuffer;

import java.nio.channels.FileChannel;
import java.nio.channels.FileLock;

public class ChannelDemo
{
    final static int MAXQUERIES = 150000;
    final static int MAXUPDATES = 150000;

    final static int RECLLEN = 16;

    static ByteBuffer buffer = ByteBuffer.allocate(RECLLEN);
    static IntBuffer intBuffer = buffer.asIntBuffer();

    static int counter = 1;

    public static void main(String[] args) throws IOException
    {
        boolean writer = false;
        if (args.length != 0)
            writer = true;
        RandomAccessFile raf = new RandomAccessFile("temp",
            (writer) ? "rw" : "r");
```

```

FileChannel fc = raf.getChannel();
if (writer)
    update(fc);
else
    query(fc);
}

static void query(FileChannel fc) throws IOException
{
    for (int i = 0; i < MAXQUERIES; i++)
    {
        System.out.println("acquiring shared lock");
        FileLock lock = fc.lock(0, RECLLEN, true);
        try
        {
            buffer.clear();
            fc.read(buffer, 0);
            int a = intBuffer.get(0);
            int b = intBuffer.get(1);
            int c = intBuffer.get(2);
            int d = intBuffer.get(3);
            System.out.println("Reading: " + a + " " +
                               b + " " +
                               c + " " +
                               d);
            if (a*2 != b || a*3 != c || a*4 != d)
            {
                System.out.println("error");
                return;
            }
        }
        finally
        {
            lock.release();
        }
    }
}

static void update(FileChannel fc) throws IOException
{
    for (int i = 0; i < MAXUPDATES; i++)
    {
        System.out.println("acquiring exclusive lock");
        FileLock lock = fc.lock(0, RECLLEN, false);
        try
        {
            intBuffer.clear();
            int a = counter;
            int b = counter*2;
            int c = counter*3;
            int d = counter*4;

```

```

        System.out.println("Writing: " + a + " " +
                           b + " " +
                           c + " " +
                           d);
        intBuffer.put(a);
        intBuffer.put(b);
        intBuffer.put(c);
        intBuffer.put(d);
        counter++;
        buffer.clear();
        fc.write(buffer, 0);
    }
    finally
    {
        lock.release();
    }
}
}
}

```

Listing 13-9 describes an application that either updates a file named `temp` or queries this file. Because file locking applies at the process level and not at the thread level, you need to run two copies of this application to demonstrate file locking for yourself. One copy will behave as a writer, updating the file. The other copy will behave as a reader, querying the file.

The `ChannelDemo` class first declares a pair of constants for controlling the duration of the update and query loops, along with a constant that denotes the length of a record. It then allocates a byte buffer that can accommodate the entire 16-byte record and an `int`-based view buffer for treating the byte buffer as a sequence of four `int` values. Finally, a counter variable initialized to 1 is declared.

The `main()` method first determines whether the application runs as a writer or runs as a reader. If you specify any command-line arguments, `writer` is assumed. This method then either opens (for a reader) or creates (for a writer) `temp` as a random access file. If this file doesn't exist when you run the application as a reader, an exception is thrown.

After opening or creating `temp`, a file channel to this file is obtained. This channel is then passed to either the `update()` or `query()` method.

Consider `update()`. This method receives the file channel argument and enters a fixed-length for loop whose duration is governed by the `MAXUPDATES` constant. After outputting a lock-acquisition message, it attempts to obtain an exclusive lock to the entire 16-byte record. If the reader process has locked that record via a shared lock, `lock()` blocks until the shared lock is released.

Once the lock is obtained, the view buffer is cleared, which sets the position to 0 and the limit to the capacity. The buffer is ready to be completely filled.

The counter variable's current value is now accessed and saved in a variable. This value is multiplied by 2, 3, and 4, and the results are also saved in their own variables. After outputting a writing message that identifies these values, `update()` makes four `put()` calls on the view buffer to store the values in the byte buffer. The counter variable is incremented and the byte buffer is cleared to ensure that it can be completely drained. Finally, the file channel's `write()` method is called to drain the buffer to the underlying `temp` file.

The `query()` method has a similar structure to the `update()` method. However, it uses the file channel to read the temp file's record, and it stores the results in the byte buffer. After outputting a message to display the read results, it verifies that the values are correct. Any deviation from what is expected causes the method to terminate after outputting an error message.

Compile Listing 13-9 (`javac ChannelDemo.java`), and execute the following command line in one command window:

```
java ChannelDemo w
```

You should observe messages similar to the following:

---

```
acquiring exclusive lock
Writing: 1 2 3 4
acquiring exclusive lock
Writing: 2 4 6 8
acquiring exclusive lock
Writing: 3 6 9 12
acquiring exclusive lock
Writing: 4 8 12 16
acquiring exclusive lock
Writing: 5 10 15 20
```

---

In a second command window, execute the following command line:

```
java ChannelDemo
```

You should observe messages similar to the following:

---

```
acquiring shared lock
Reading: 2500 5000 7500 10000
acquiring shared lock
Reading: 2501 5002 7503 10004
acquiring shared lock
Reading: 2502 5004 7506 10008
acquiring shared lock
Reading: 2503 5006 7509 10012
acquiring shared lock
Reading: 2504 5008 7512 10016
```

---

If you run these applications until they finish, you should observe no error messages. The file locking ensures that only the writer process or the reader process can access temp's 16-byte record. The other process is denied while these bytes are locked. As a result, there can be no corruption to this record's values.



To prove to yourself that the file locking is actually working, comment out the following four lines from the previous listing, recompile `ChannelDemo.java`, and re-run this application as a writer and as a reader:

```
FileLock lock = fc.lock(0, RECLEN, true);  
FileLock lock = fc.lock(0, RECLEN, false);  
lock.release();  
lock.release();
```

At some point during the execution, you should observe output similar to that shown below:

```
acquiring shared lock  
Reading: 803 1606 2412 3216  
error
```

The output is invalid—it should be `803 1606 2409 3212` but it isn't because the reader and writer were able to access the record at the same time.

**Note** The more `ChannelDemo` reader processes that run, the slower a `ChannelDemo` writer process will run. Eventually, the `ChannelDemo` writer process will block during a lock acquisition attempt and not unblock because there will always be a shared lock in use.

## Mapping Files into Memory

`FileChannel` declares a `map()` method that lets you create a virtual memory mapping between a region of an open file and a `MappedByteBuffer` instance that wraps itself around this region. This mapping mechanism offers an efficient way to access a file because no time-consuming system calls are needed to perform I/O.

**Note** *Virtual memory* is a kind of memory in which virtual addresses (also known as artificial addresses) replace physical (RAM memory) addresses. Check out Wikipedia's "Virtual memory" topic ([http://en.wikipedia.org/wiki/Virtual\\_memory](http://en.wikipedia.org/wiki/Virtual_memory)) to learn more about virtual memory.

The `map()` method has the following signature:

```
MappedByteBuffer map(FileChannel.MapMode mode, long position, long size)
```

The `mode` parameter defines the mapping mode and receives one of the following constants defined by the `FileChannel.MapMode` enumerated type:

- `READ_ONLY`: Any attempt to modify the buffer will cause `ReadOnlyBufferException` to be thrown.
- `READ_WRITE`: Changes made to the resulting buffer will eventually be propagated to the file; they may or may not be made visible to other programs that have mapped the same file.
- `PRIVATE`: Changes made to the resulting buffer will not be propagated to the file, and they will not be visible to other programs that have mapped the same file. Instead, changes will cause private copies of the modified portions of the buffer to be created. These changes are lost when the buffer is garbage collected.

The specified mapping mode is constrained by the invoking `FileChannel` object's access permissions. For example, if the file channel was opened as a read-only channel, and if you request `READ_WRITE` mode, `map()` will throw `NonWritableChannelException` because it cannot write to the file channel. Similarly, `NonReadableChannelException` is thrown when the channel was opened as write-only and you request `READ_ONLY` mode. (You can request `READ_ONLY` for a file channel opened as a read-write channel.)

**Tip** Invoke `MappedByteBuffer`'s `isReadOnly()` method to determine whether or not you can modify the mapped file.

The `position` and `size` parameters define the start and extent of the mapped region. Arguments passed to these parameters must be nonnegative. Furthermore, the argument passed to `size` must not exceed `Integer.MAX_VALUE`.

The specified range shouldn't exceed the file's size because the file will be made larger to accommodate the range. For example, if you pass `Integer.MAX_VALUE` to `size`, the file will grow to more than 2GB. Also, for a read-only mapping, `map()` will probably throw `IOException`.

The returned `MappedByteBuffer` object behaves like a memory-mapped buffer, but its contents are stored in a file. When you invoke `get()` on this object, the current contents of the file are obtained, even when these contents have been modified by an external program. Similarly, when you have write permission, invoking `put()` updates the file and changes are available to external programs.

**Note** Because mapped byte buffers are direct byte buffers, the memory space assigned to them exists outside of the virtual machine's heap.

Consider the following example:

```
MappedByteBuffer buffer = fileChannel.map(FileChannel.MapMode.READ_ONLY, 50, 100);
```

This example maps a subrange, from location 50 through location 149, of the file described by `fileChannel`. In contrast, the following example maps the entire file:

```
MappedByteBuffer buffer = fileChannel.map(FileChannel.MapMode.READ_ONLY, 0, fileChannel.size());
```

There is no `unmap()` method. Once a mapping is established, it remains until the `MappedByteBuffer` object is garbage collected (or the application exits, whichever happens first). Because a mapped byte buffer isn't connected to the file channel by which it was created, the mapping isn't destroyed when the file channel is closed.

`MappedByteBuffer` inherits methods from its `ByteBuffer` superclass. It also declares the following methods:

- `MappedByteBuffer load()`: Attempts to load all of the mapped file content into memory. This results in much faster access for large files because the virtual memory manager doesn't have to load portions of the file into memory as those portions are requested (by reading from/writing to their locations) while traversing the mapped buffer. Although `load()` makes a best effort, it may not succeed because external programs may cause the virtual memory manager to remove portions of the loaded file content to make room for their requests to load content into physical memory. Also, `load()` can be expensive time-wise because it can cause the virtual memory manager to perform many I/O operations; it may take time for this method to complete.
- `boolean isLoaded()`: Returns true when all of the mapped file content has been loaded into memory; otherwise, returns false. If this method returns true, you can probably access all of the content with few or no I/O operations. If this method returns false, it's still possible that buffer access will be fast and that the mapped content will be entirely resident in memory. Think of `isLoaded()` as hinting at the mapped byte buffer's status.
- `MappedByteBuffer force()`: Causes changes made to the mapped byte buffer to be written out to permanent storage. When working with mapped byte buffers, you should invoke this method instead of the file channel's `force()` method because the channel might be unaware of various changes made through the mapped byte buffer. Calling this method has no effect for `READ_ONLY` and `PRIVATE` mappings.

Listing 13-10 presents an application that demonstrates file mapping.

*Listing 13-10. Demonstrating File Mapping*

```
import java.io.IOException;
import java.io.RandomAccessFile;

import java.nio.ByteBuffer;
import java.nio.MappedByteBuffer;

import java.nio.channels.FileChannel;
```

```

public class ChannelDemo
{
    public static void main(String[] args) throws IOException
    {
        if (args.length != 1)
        {
            System.out.println("usage: java ChannelDemo filespec");
            return;
        }
        RandomAccessFile raf = new RandomAccessFile(args[0], "rw");
        FileChannel fc = raf.getChannel();
        long size = fc.size();
        System.out.println("Size: " + size);
        MappedByteBuffer mbb = fc.map(FileChannel.MapMode.READ_WRITE, 0, size);
        while (mbb.remaining() > 0)
            System.out.print((char) mbb.get());
        System.out.println();
        System.out.println();
        for (int i = 0; i < mbb.limit()/2; i++)
        {
            byte b1 = mbb.get(i);
            byte b2 = mbb.get(mbb.limit()-i-1);
            mbb.put(i, b2);
            mbb.put(mbb.limit()-i-1, b1);
        }
        mbb.flip();
        while (mbb.remaining() > 0)
            System.out.print((char) mbb.get());
        fc.close();
    }
}

```

After verifying that you've specified a single command-line argument, which should identify an existing file, `main()` creates a `RandomAccessFile` object for accessing this file in read/write mode. It then obtains a file channel for communicating with this file.

After using the file channel to obtain the file size, which is subsequently output, `main()` uses the file channel to invoke `map()` to obtain a read/write mapping of the entire file. It subsequently outputs the contents of the returned mapped byte buffer.

Later on, `main()` enters a for loop whose purpose is to reverse the file's contents. In each of the iterations, two bytes that mirror each other are obtained and then swapped. After leaving this loop, `main()` flips the buffer for draining and outputs its reversed contents.

Compile Listing 13-10 (`javac ChannelDemo.java`) and, assuming the existence of a `poem.txt` file, execute the following command line to reverse this file's contents:

```
java ChannelDemo poem.txt
```

You should observe output similar to the following:

---

```
Size: 67
Roses are red,
Violets are blue,
Sugar is sweet,
And so are you!

!uoy era os dnA
,teews si raguS
,eulb era steloiv
,der era sesoR
```

---

The blank lines in the reversed text result from reversing the carriage return (13)/line feed (10) sequences on Windows platforms. Also, the contents of poem.txt should be reversed.

## Transferring Bytes Among Channels

To optimize the common practice of performing bulk transfers, two methods have been added to `FileChannel` that avoid the need for intermediate buffers:

- `long transferFrom(ReadableByteChannel src, long position, long count):`  
Transfers bytes into this channel's file from the given readable byte channel. Parameter `src` identifies the source channel, `position` identifies the nonnegative start position in the file where the transfer is to start, and `count` identifies the nonnegative maximum number of bytes that are to be transferred. This method returns the number of bytes (possibly 0) that were actually transferred. It throws `IllegalArgumentException` when a precondition on a parameter (such as `position` being nonnegative) doesn't hold; `NonReadableChannelException` when the source channel wasn't opened for reading; `NonWritableChannelException` when this channel wasn't opened for writing; `ClosedChannelException` when this channel or the source channel is closed; `ClosedByInterruptException` when another thread interrupts the current thread while the transfer is in progress, thereby closing both channels and setting the current thread's interrupt status; and `IOException` when some other I/O error occurs.
- `long transferTo(long position, long count, WritableByteChannel target):`  
Transfers bytes from this channel's file to the given writable byte channel. Parameter `position` identifies the nonnegative start position in the file where the transfer is to start, `count` identifies the nonnegative maximum number of bytes that are to be transferred, and `target` identifies the target channel. This method returns the number of bytes (possibly 0) that were actually transferred. It throws `IllegalArgumentException` when a precondition on a parameter doesn't hold; `NonReadableChannelException` when this channel wasn't opened for reading; `NonWritableChannelException` when the target channel wasn't opened for

writing; `ClosedChannelException` when this channel or the target channel is closed; `ClosedByInterruptException` when another thread interrupts the current thread while the transfer is in progress, thereby closing both channels and setting the current thread's interrupt status; and `IOException` when some other I/O error occurs.

If you're using `transferTo()` with a file channel as the transfer source, the transfer stops at the end of the file when position plus count exceeds the file's size. Similarly, `transferFrom()` stops when `src` is a file channel and its end of file is reached.

Listing 13-11 presents an application that demonstrates channel transfer.

*Listing 13-11. Demonstrating Channel Transfer*

```
import java.io.FileInputStream;
import java.io.IOException;

import java.nio.channels.Channels;
import java.nio.channels.FileChannel;
import java.nio.channels.WritableByteChannel;

public class ChannelDemo
{
    public static void main(String[] args)
    {
        if (args.length != 1)
        {
            System.err.println("usage: java ChannelDemo filespec");
            return;
        }

        FileInputStream fis = null;
        try
        {
            fis = new FileInputStream(args[0]);
            FileChannel inChannel = fis.getChannel();
            WritableByteChannel outChannel = Channels.newChannel(System.out);
            inChannel.transferTo(0, inChannel.size(), outChannel);
        }
        catch (IOException ioe)
        {
            System.out.println("I/O error: " + ioe.getMessage());
        }
        finally
        {
            if (fis != null)
                try
                {
                    fis.close();
                }
        }
    }
}
```

```

        catch (IOException ioe)
        {
        }
    }
}

```

Listing 13-11's `main()` method verifies that a single command-line argument has been specified. This argument identifies a file whose contents are to be copied to the standard output stream.

Next, `main()` creates a file input stream to the file identified by the command-line argument and a file channel for reading from this file.

Finally, an output channel for sending bytes to the standard output stream is obtained and the input file channel's `transferTo()` method is called to transfer the file content to standard output.

Compile Listing 13-11 (`javac ChannelDemo.java`), and execute the following command line to make a copy of `ChannelDemo.java`:

```
java ChannelDemo ChannelDemo.java >ChannelDemo.bak
```

You should observe a `ChannelDemo.bak` file with size and contents identical to `ChannelDemo.java`.

## Socket Channels

I previously mentioned that `Socket` declares a `SocketChannel` `getChannel()` method for returning a socket channel instance, which describes an open connection to a socket. Unlike sockets, socket channels are selectable and can function in nonblocking mode. These capabilities (discussed later in this chapter) enhance the scalability and flexibility of large applications (such as web servers).

**Note** Although you might not care about scalability and flexibility when developing an Android app, suppose that your app needs to communicate with a custom web server that you must also create. When many instances of your app need to simultaneously communicate with the server, you'll appreciate being able to leverage the selectable and nonblocking mode capabilities of socket channels to ensure that the server is responsive to each app instance. After all, why risk angry customers?

Socket channels are described by the abstract `java.nio.channels.ServerSocketChannel`, `java.nio.channels.SocketChannel`, and `java.nio.channels.DatagramChannel` classes. Each class ultimately extends `java.nio.channels.SelectableChannel` and implements `InterruptibleChannel`, making `ServerSocketChannel`, `SocketChannel`, and `DatagramChannel` instances selectable and interruptible. Because `SocketChannel` and `DatagramChannel` implement the `ByteChannel`, `GatheringByteChannel`, and `ScatteringByteChannel` interfaces, you can write to, read from, and perform scattering I/O on their underlying sockets.

**Note** Unlike buffers, which are not thread-safe, server socket channels, socket channels, and datagram channels are thread-safe.

Each `ServerSocketChannel`, `SocketChannel`, and `DatagramChannel` instance creates a peer socket object from the `java.net.ServerSocket`, `Socket`, or `java.net.DatagramSocket` class; each class has been retrofitted to work with channels. You can obtain the peer socket object by invoking `ServerSocketChannel`'s, `SocketChannel`'s, or `DatagramChannel`'s `socket()` method.

**Note** When invoked on the socket instance returned from `socket()`, `getChannel()` returns the associated socket channel. However, when invoked on a socket obtained by instantiating `ServerSocket`, `Socket`, or `DatagramSocket`, `getChannel()` returns null.

## Understanding Nonblocking Mode

The blocking nature of sockets created from Java's socket classes is a serious limitation to a network-oriented Java application's scalability. For example, the `ServerSocket` class's `Socket` `accept()` method blocks until an incoming connection arrives, at which point it creates and returns a `Socket` instance that lets the server communicate with the client. If this method didn't block, scalability would improve because the server could be accomplishing other useful work instead of having to wait.

The abstract `SelectableChannel` class is a common ancestor of the `ServerSocketChannel`, `SocketChannel`, and `DatagramChannel` classes. In addition to letting the socket channel work in a selector context (I discuss selectors later in this chapter), `SelectableChannel` lets socket channels choose to block or operate in *nonblocking mode*.

**Note** `SelectableChannel` merges functionality related to selectors with nonblocking mode because nonblocking mode is most useful in conjunction with selector-based multiplexing.

`SelectableChannel` offers the following methods for enabling blocking or nonblocking, determining whether the channel is blocking or nonblocking, and obtaining the blocking lock:

- `SelectableChannel` `configureBlocking(boolean block)`: Specifies the calling selectable channel's blocking status. Pass `true` to make the channel blocking and `false` to make the channel nonblocking. The method returns the selectable channel or throws an exception: `ClosedChannelException` when the channel is closed, `java.net.channels.IllegalBlockingModeException` when `block` is `true` and the channel has been registered with one or more selectors, and `IOException` when an I/O error occurs.



- `boolean isBlocking()`: This method returns true when the calling selectable channel is blocking; otherwise, false returns. Newly created channels default to blocking.
- `Object blockingLock()`: Returns the object on which `configureBlocking()` synchronizes. The returned object is useful in the implementation of adaptors that require the current blocking mode value to not change for a short period of time.

It's trivial to set or reset a selectable channel's blocking/nonblocking status. To enable nonblocking, pass false to an invocation of `configureBlocking()`, which the following example demonstrates:

```
ServerSocketChannel ssc = ServerSocketChannel.open();
ssc.configureBlocking(false); // enable nonblocking mode
```

Although nonblocking sockets are commonly used in server-oriented applications, they are also beneficial on the client side. For example, a GUI application can leverage nonblocking sockets to keep the user interface responsive while communicating simultaneously with several server applications.

The `blockingLock()` method lets you prevent other threads from changing a socket channel's blocking/nonblocking status. This method returns the object that a channel implementation uses for synchronizing when changing this status. Only the thread that holds the lock on this object can change the status, and the lock is often obtained by using Java's synchronized keyword. Consider the following example:

```
ServerSocketChannel ssc = ServerSocketChannel.open();
SocketChannel sc = null;
Object lock = ssc.blockingLock();

// Thread might block when obtaining the lock associated with
// the lock object.
synchronized(lock)
{
    // Current thread owns the lock. No other thread can
    // change blocking mode.

    // Obtaining server socket channel's current blocking mode.
    boolean blocking = ssc.isBlocking();

    // Set server socket channel to nonblocking.
    ssc.configureBlocking(false);

    // Obtain next connection, which is null when there is no
    // connection.
    sc = ssc.accept();

    // Restore previous blocking mode.
    ssc.configureBlocking(blocking);
}
```

```
// The lock is released and some other thread may modify the
// server socket channel's blocking mode.
if (sc != null)
    communicateWithSocket(sc);
```

## Exploring Server Socket Channels

`ServerSocketChannel` is the simplest of the three socket channel classes. This class includes the following methods:

- `static ServerSocketChannel open()`: Attempts to open a server-socket channel, which is initially unbound; it must be bound to a specific address via one of its peer socket's `bind()` methods before connections can be accepted. If the channel cannot be opened, `IOException` is thrown.
- `ServerSocket socket()`: Returns the peer `ServerSocket` instance associated with this server socket channel.
- `SocketChannel accept()`: Accepts the connection made to this channel's socket. If this channel is nonblocking, `accept()` immediately returns null when there are no pending connections or returns a socket channel that represents the connection. Otherwise, when the channel is blocking, `accept()` blocks indefinitely until a new connection is available or an I/O error occurs. The socket channel returned by this method is blocking regardless of whether the server socket channel is blocking or nonblocking. This method throws `ClosedChannelException` when the server socket channel is closed, `AsynchronousCloseException` when another thread closes this server socket channel while the `accept` operation is in progress, `java.nio.channels.NotYetBoundException` when the server socket channel hasn't been bound, or `IOException` when an I/O error occurs.

A server socket channel behaves as a server in the TCP/IP stream protocol. You use server socket channels to listen for incoming connections with clients.

You create a new server socket channel by invoking the static `open()` factory method. If all goes well, `open()` returns a `ServerSocketChannel` instance associated with an unbound peer `ServerSocket` object. You can obtain this object by invoking `socket()`, and then invoke `ServerSocket`'s `bind()` method to bind the server socket (and ultimately the server socket channel) to a specific address.

You can then invoke `ServerSocketChannel`'s `accept()` method to accept an incoming connection. Depending on whether or not you have configured the server socket channel to be nonblocking, this method either returns immediately with null or a socket channel to an incoming connection, or blocks until there is an incoming connection.

**Note** Alternatively, you can invoke `accept()` on the peer `ServerSocket` object that `socket()` returns. However, this `accept()` method will always block.

Listing 13-12 presents a `ChannelServer` application that demonstrates `ServerSocketChannel`.

*Listing 13-12. Demonstrating `ServerSocketChannel`*

```
import java.io.IOException;

import java.net.InetSocketAddress;

import java.nio.ByteBuffer;

import java.nio.channels.ServerSocketChannel;
import java.nio.channels.SocketChannel;

public class ChannelServer
{
    public static void main(String[] args) throws IOException
    {
        System.out.println("Starting server...");
        ServerSocketChannel ssc = ServerSocketChannel.open();
        ssc.socket().bind(new InetSocketAddress(9999));
        ssc.configureBlocking(false);
        String msg = "Local address: " + ssc.socket().getLocalSocketAddress();
        ByteBuffer buffer = ByteBuffer.wrap(msg.getBytes());
        while (true)
        {
            System.out.print(".");
            SocketChannel sc = ssc.accept();
            if (sc != null)
            {
                System.out.println();
                System.out.println("Received connection from " +
                    sc.socket().getRemoteSocketAddress());

                buffer.rewind();
                sc.write(buffer);
                sc.close();
            }
            else
                try
                {
                    {
                        Thread.sleep(100);
                    }
                }
                catch (InterruptedException ie)
                {
                    {
                        assert false; // shouldn't happen
                    }
                }
            }
        }
    }
}
```

Listing 13-12's `main()` method first outputs a startup message and then obtains a server socket channel. Continuing, it accesses the `ServerSocket` peer object and uses this object to bind the socket/channel to port 9999.

Next, `main()` configures the server socket channel to be nonblocking and creates a byte buffer based on a message that identifies the server socket channel's local socket address.

`main()` now enters a while loop that repeatedly prints a single period character to demonstrate the channel's nonblocking status and checks for an incoming connection. If a connection is detected, its `SocketChannel` instance is used to obtain the remote socket address, which is output to the standard output stream. The buffer is then rewound and its content written to the socket channel, which is then closed. However, if a connection isn't detected, `main()` sleeps for a fraction of a second.

Compile Listing 13-12 as follows:

```
javac ChannelServer.java
```

Execute the following command to start the server:

```
java ChannelServer
```

You should observe a starting `server...` message followed by a growing sequence of periods across the screen from left to right. At this point, there's nothing further to observe.

## Exploring Socket Channels

`SocketChannel` is the most commonly used of the three socket channel classes, and it models a connection-oriented stream protocol (such as TCP/IP). This class includes the following methods:

- `static SocketChannel open():` Attempts to open a socket channel. If the channel cannot be opened, `IOException` is thrown.
- `static SocketChannel open(InetSocketAddress remoteAddr):` Attempts to open a socket channel and connect it to `remoteAddr`. This convenience method works as if by invoking the `open()` method, invoking the `connect()` method upon the resulting socket channel, passing it `remoteAddr`, and then returning that channel. This method throws `AsynchronousCloseException` when another thread closes this channel while the connect operation is in progress; `ClosedByInterruptException` when another thread interrupts the current thread while the connect operation is in progress, thereby closing the channel and setting the current thread's interrupt status; `java.nio.channels.UnresolvedAddressException` when the given remote address isn't fully resolved; `java.nio.channels.UnsupportedAddressTypeException` when the type of the given remote address isn't supported; and `IOException` when some other I/O error occurs.
- `Socket socket():` Returns the peer `Socket` instance associated with this socket channel.
- `boolean connect(SocketAddress remoteAddr):` Attempts to connect this socket channel's socket object to the remote address. If this channel is nonblocking, an invocation of this method initiates a nonblocking connection operation. If the connection is established immediately, as can happen with a local connection, this method returns `true`. Otherwise, this method returns `false` and the connection operation must be subsequently completed by repeatedly

invoking the `finishConnect()` method until this method returns true. This method throws `java.nio.channels.AlreadyConnectedException` when this channel is already connected; `java.nio.channels.ConnectionPendingException` when a nonblocking connection operation is already in progress on this channel; `ClosedChannelException` when this channel is closed; `AsynchronousCloseException` when another thread closes this channel while the connect operation is in progress; `ClosedByInterruptException` when another thread interrupts the current thread while the connect operation is in progress, thereby closing the channel and setting the current thread's interrupt status; `UnresolvedAddressException` when the given remote address isn't fully resolved; `UnsupportedAddressTypeException` when the type of the given remote address isn't supported; and `IOException` when some other I/O error occurs.

- `boolean isConnectionPending()`: Returns true when a connection operation is pending completion; otherwise, returns false.
- `boolean finishConnect()`: Finishes the process of connecting a socket channel. This method returns true when the socket channel is fully connected; otherwise, returns false. This method throws `java.nio.channels.NoConnectionPendingException` when this channel isn't connected and a connection operation hasn't been initiated; `ClosedChannelException` when this channel is closed; `AsynchronousCloseException` when another thread closes this channel while the connect operation is in progress; `ClosedByInterruptException` when another thread interrupts the current thread while the connect operation is in progress, thereby closing the channel and setting the current thread's interrupt status; and `IOException` when some other I/O error occurs.
- `boolean isConnected()`: Returns true when this channel's socket is open and connected; otherwise, returns false.

A socket channel behaves as a client in the TCP/IP stream protocol. You use socket channels to initiate connections to listening servers.

Create a new socket channel by calling either of the `open()` methods. Behind the scenes a peer `Socket` object is created. Invoke `SocketChannel`'s `socket()` method to return this peer object. Also, you can return the original socket channel by invoking `getChannel()` on the peer `Socket` object.

A socket channel obtained from the noargument `open()` method isn't connected. Attempting to read from or write to this socket channel results in `java.nio.channels.NotYetConnectedException`. To connect the socket, call the `connect()` method on the socket channel or on its peer socket.

After a socket channel has been connected, it remains connected until closed. To determine if a socket channel is connected, invoke `SocketChannel`'s `boolean isConnected()` method.

The `open()` method that takes a `java.net.InetSocketAddress` argument also lets you connect to another host at the specified remote address, as follows:

```
SocketChannel sc = SocketChannel.open(new InetSocketAddress("localhost", 9999));
```

This convenience method is equivalent to invoking the following code sequence:

```
SocketChannel sc = SocketChannel.open();
sc.connect(new InetSocketAddress("localhost", 9999));
```

When connecting to a server via the peer `Socket` object or via `SocketChannel`'s `connect()`/`secondOpen()` method on a blocking socket channel, the thread that invokes `connect()` blocks until the socket channel is connected. However, when the socket channel isn't blocking, `connect()` returns immediately, typically with `false` to indicate that the connection hasn't been made (although it might return `true` for a local loopback connection). Because a connection must be established before you can perform I/O on the socket channel, you need to invoke `finishConnect()` repeatedly until this method returns `true`.

Listing 13-13 presents a `ChannelClient` application that demonstrates `SocketChannel`.

*Listing 13-13. Demonstrating SocketChannel*

```
import java.io.IOException;

import java.net.InetSocketAddress;

import java.nio.ByteBuffer;

import java.nio.channels.SocketChannel;

public class ChannelClient
{
    public static void main(String[] args)
    {
        try
        {
            SocketChannel sc = SocketChannel.open();
            sc.configureBlocking(false);
            InetSocketAddress addr = new InetSocketAddress("localhost", 9999);
            sc.connect(addr);

            while (!sc.finishConnect())
                System.out.println("waiting to finish connection");

            ByteBuffer buffer = ByteBuffer.allocate(200);
            while (sc.read(buffer) >= 0)
            {
                buffer.flip();
                while (buffer.hasRemaining())
                    System.out.print((char) buffer.get());
                buffer.clear();
            }
            sc.close();
        }
    }
}
```

```

    catch (IOException ioe)
    {
        System.err.println("I/O error: " + ioe.getMessage());
    }
}
}

```

Listing 13-13's `main()` method first obtains a socket channel and configures it to be nonblocking. It then creates an address to the previous channel server application and initiates a connection to this address. Because of the nonblocking status, it's necessary to invoke `finishConnect()` repeatedly until this method returns true, which indicates a connection to the remote server application.

`main()` subsequently creates a byte buffer and enters a loop that repeatedly reads content into this buffer and outputs this content to the standard output stream. The channel is then closed.

Compile Listing 13-13 via the following command:

```
javac ChannelClient.java
```

Assuming that the channel server is running, execute the following command to start the client:

```
java ChannelClient
```

You should observe a message similar to the following on the channel server output stream:

---

```
Received connection from /127.0.0.1:51177
```

---

You should also observe the following message on the channel client output stream:

---

```
Local address: /0:0:0:0:0:0:0:9999
```

---

## Exploring Datagram Channels

`DatagramChannel` models a connectionless packet-oriented protocol (such as UDP/IP). This class includes the following methods:

- `static DatagramChannel open()`: Attempts to open a datagram channel. If the channel cannot be opened, `IOException` is thrown.
- `DatagramSocket socket()`: Returns the peer `DatagramSocket` instance associated with this datagram channel.
- `DatagramChannel connect(SocketAddress remoteAddr)`: Attempts to connect this datagram channel's socket object to the remote address. The channel's socket is configured so that it only receives datagrams from and sends datagrams to the given address. Once connected, datagrams cannot be received from or sent to any other address. A datagram socket remains connected until explicitly disconnected or closed. This method returns the datagram channel upon success. It throws `ClosedChannelException` when the datagram channel is closed; `AsynchronousCloseException` when another thread closes this channel

while the connect operation is in progress; `ClosedByInterruptedException` when another thread interrupts the current thread while the connect operation is in progress, thereby closing the channel and setting the current thread's interrupt status; and `IOException` when some other I/O error occurs.

- `boolean isConnected()`: Returns true when this channel's socket is open and connected; otherwise, returns false.
- `DatagramChannel disconnect()`: Disconnects this channel's socket. This method may be invoked at any time and has no effect on read or write operations that are already in progress. When the socket isn't connected or when the channel is closed, invoking this method has no effect.
- `SocketAddress receive(ByteBuffer buffer)`: Receives a datagram via this channel. If a datagram is immediately available or if this channel is blocking and a datagram becomes available, the datagram is copied into the given byte buffer and its source address is returned. If this channel is nonblocking and a datagram isn't immediately available, this method immediately returns null. The datagram is transferred into the given byte buffer starting at its current position, as if by a regular read operation. If there are fewer bytes remaining in the buffer than are required to hold the datagram, the remainder of the datagram is silently discarded. This method returns the datagram's source address or null when the channel isn't blocking and no datagram is available. It throws `ClosedChannelException` when the datagram channel is closed; `AsynchronousCloseException` when another thread closes this channel while the read operation is in progress; `ClosedByInterruptedException` when another thread interrupts the current thread while the read operation is in progress, thereby closing the channel and setting the current thread's interrupt status; and `IOException` when some other I/O error occurs.
- `int send(ByteBuffer buffer, SocketAddress destAddr)`: Sends a datagram via this channel. If this channel is nonblocking and there is sufficient room in the underlying output buffer, or if this channel is blocking and sufficient room becomes available, the remaining bytes in the given buffer are transmitted as a single datagram to the given destination address. The datagram is transferred from the byte buffer as if by a regular write operation. This method returns the number of bytes sent, which will be the number of bytes that were remaining in the source buffer when this method was invoked or, when this channel is nonblocking, may be zero if there was insufficient room for the datagram in the underlying output buffer. It throws `ClosedChannelException` when the datagram channel is closed; `AsynchronousCloseException` when another thread closes this channel while the write operation is in progress; `ClosedByInterruptedException` when another thread interrupts the current thread while the write operation is in progress, thereby closing the channel and setting the current thread's interrupt status; and `IOException` when some other I/O error occurs.

Additionally, there are several `read()` and `write()` methods that you might like to use. Unlike `send()` and `receive()`, which don't require the datagram channel to be connected, the `read()` and `write()` methods require a connection.



As with `ServerSocketChannel` and `SocketChannel`, you obtain a `DatagramChannel` instance by invoking the static `open()` method. The new datagram channel is associated with a peer `DatagramSocket` object, which you can obtain by invoking `DatagramChannel`'s `socket()` method.

A datagram channel can behave as both a client (the sender) and a server (the listener). To act as a listener, the datagram channel must be bound to a port and an optional address. Accomplish this task by obtaining the `DatagramSocket` object and invoking `bind()` on this object, as follows:

```
DatagramChannel dc = DatagramChannel.open();
DatagramSocket ds = dc.socket();
ds.bind(new InetSocketAddress(9999); // bind to port 9999
```

The `receive()` method copies the incoming datagram's data payload into the byte buffer argument and returns a socket address identifying the datagram's source address. If the channel is blocking, `receive()` sleeps until the packet arrives or some event results in a thrown exception. If the channel is nonblocking, `receive()` returns null when a datagram isn't available. If the data payload is larger than will fit in the buffer, excess bytes are quietly removed.

The `send()` method sends the given byte buffer's content, starting from the current position and ranging to the buffer's limit, to the destination address/port number specified by the socket address argument. If the datagram channel is blocking, `send()` sleeps until the datagram is queued for sending or some event results in a thrown exception. If the channel isn't blocking, this method returns with one of two values: the entire length of the buffer content that was sent or 0 indicating that the buffer content wasn't sent—nothing is sent when there isn't room to store the entire datagram before transmission.

**Note** Datagram protocols aren't reliable. For one thing, they don't guarantee delivery. As a result, a nonzero return value from `send()` doesn't mean that the datagram reached its destination. Also, the underlying network might fragment the datagram into multiple smaller packets. When a datagram is fragmented, it's more probable for one or more of these packets not to arrive at the destination. Because the receiver cannot reassemble all of the packets, the entire datagram is discarded. For this reason, data payloads should be restricted to several hundred bytes maximum.

An example of where you might require a datagram channel is a stock ticker that offers the latest stock prices for a given company. A client would submit a company's stock symbol (such as MSFT for Microsoft) as a datagram payload and receive a datagram in response whose payload provides the requested stock prices. Because the latest information is desired, the client would re-request the stock prices when a response datagram doesn't arrive.

Listing 13-14 presents a `ChannelServer` application that leverages `DatagramChannel` to implement the server portion of the stock ticker.

*Listing 13-14. Using DatagramChannel to Implement a Stock Ticker Server*

```

import java.io.IOException;

import java.net.InetSocketAddress;
import java.net.SocketAddress;

import java.nio.ByteBuffer;

import java.nio.channels.DatagramChannel;

public class ChannelServer
{
    final static int PORT = 9999;

    public static void main(String[] args) throws IOException
    {
        System.out.println("server starting and listening on port " +
            PORT + " for incoming requests...");
        DatagramChannel dcServer = DatagramChannel.open();
        dcServer.socket().bind(new InetSocketAddress(PORT));
        ByteBuffer symbol = ByteBuffer.allocate(4);
        ByteBuffer payload = ByteBuffer.allocate(16);
        while (true)
        {
            payload.clear();
            symbol.clear();
            SocketAddress sa = dcServer.receive(symbol);
            if (sa == null)
                return;
            System.out.println("Received request from " + sa);
            String stockSymbol = new String(symbol.array(), 0, 4);
            System.out.println("Symbol: " + stockSymbol);
            if (stockSymbol.toUpperCase().equals("MSFT"))
            {
                payload.putFloat(0, 37.40f); // open share price
                payload.putFloat(4, 37.22f); // low share price
                payload.putFloat(8, 37.48f); // high share price
                payload.putFloat(12, 37.41f); // close share price
            }
            else
            {
                payload.putFloat(0, 0.0f);
                payload.putFloat(4, 0.0f);
                payload.putFloat(8, 0.0f);
                payload.putFloat(12, 0.0f);
            }
            dcServer.send(payload, sa);
        }
    }
}

```

Listing 13-14's `main()` method first creates a datagram channel and binds it to port 9999. It then creates two byte buffers to hold a 4-byte stock symbol and a 16-byte response, which is organized into four 4-byte floating-point values representing open share price, low share price, high share price, and close share price.

**Note** For convenience, I'm representing currency amounts as floating-point values. This is not a good idea in practice and `java.math.BigDecimal` should be used instead. Also, you wouldn't embed stock prices in the source code but would dynamically obtain them from some kind of external server or database.

`main()` now enters an infinite loop that clears both byte buffers in preparation for receiving new information from a client and receives the next stock symbol. The subsequent `if` statement that tests `sa` for `null` isn't necessary for this application but is present in case you want to configure the channel for nonblocking mode.

After outputting a message identifying the request, `main()` checks the stock symbol to see if it equals `MSFT`. If so, the payload byte buffer is configured to store four stock prices for Microsoft stock; otherwise, the payload byte buffer is configured to store four 0 prices (to indicate unknown stock symbol).

Finally, `main()` sends the payload datagram payload to the receiver and continues to loop.

Compile Listing 13-14 via the following command:

```
javac ChannelServer.java
```

Run the application as follows:

```
java ChannelServer
```

You should observe the following message:

---

```
server starting and listening on port 9999 for incoming requests...
```

---

Listing 13-15 presents a `ChannelClient` application that leverages `DatagramChannel` to implement the client portion of the stock ticker.

*Listing 13-15. Using `DatagramChannel` to Implement a Stock Ticker Client*

```
import java.io.IOException;
import java.net.InetSocketAddress;
import java.nio.ByteBuffer;
import java.nio.channels.DatagramChannel;

public class ChannelClient
{
    final static int PORT = 9999;
```

```

public static void main(String[] args) throws IOException
{
    if (args.length != 1)
    {
        System.err.println("usage: java ChannelClient stocksymbol");
        return;
    }

    DatagramChannel dcClient = DatagramChannel.open();

    ByteBuffer symbol = ByteBuffer.wrap(args[0].getBytes());
    ByteBuffer response = ByteBuffer.allocate(16);

    InetSocketAddress sa = new InetSocketAddress("localhost", PORT);
    dcClient.send(symbol, sa);
    System.out.println("Receiving datagram from " +
        dcClient.receive(response));
    System.out.println("Open price: " + response.getFloat(0));
    System.out.println("Low price: " + response.getFloat(4));
    System.out.println("High price: " + response.getFloat(8));
    System.out.println("Close price: " + response.getFloat(12));
}
}

```

Listing 13-15's `main()` method first verifies that a single command-line argument has been specified. This argument identifies a stock symbol. It then creates a datagram channel and a pair of byte buffers: `symbol` stores the specified symbol and `response` stores the response from the server.

Next, `main()` creates a socket address for communicating with and sends the `symbol` buffer to the server. It then receives a response datagram from the server, storing its payload in the `response` buffer.

Finally, `main()` accesses the response buffer, using `getFloat()` to convert each set of 4 bytes to a floating-point value, which is subsequently output.

Compile Listing 13-15 via the following command:

```
javac ChannelClient.java
```

Run this application as follows:

```
java ChannelClient msft
```

Assuming that the server is still running, you should observe the following messages in the server window:

---

```

Received request from /127.0.0.1:64837
Symbol: msft

```

---

Also, you should observe the following output in the client window:

---

```
Receiving datagram from /127.0.0.1:9999
Open price: 37.4
Low price: 37.22
High price: 37.48
Close price: 37.41
```

---

## Pipes

The `java.nio.channels` package includes a `Pipe` class. `Pipe` describes a pair of channels that implement a unidirectional *pipe*, which is a conduit for passing data in one direction between two entities, such as two file channels or two socket channels. `Pipe` is analogous to the `java.io.PipedInputStream` and `java.io.PipedOutputStream` classes—see Chapter 11.

This class declares nested `SourceChannel` and `SinkChannel` classes that serve as readable and writable byte channels, respectively. `Pipe` also declares the following methods:

- `static Pipe open()`: This class method opens a new pipe, throwing `IOException` when an I/O error occurs.
- `SourceChannel source()`: This method returns the pipe's source channel.
- `SinkChannel sink()`: This method returns the pipe's sink channel.

Pipes can be used to pass data within the same virtual machine; you cannot use them to pass data between the virtual machine and an external program. Pipes are ideal in producer/consumer scenarios because of encapsulation: you can use the same code to write data to files, sockets, or pipes depending upon the kind of channel presented to the pipe.

Listing 13-16 presents a producer/consumer application that uses a pipe to achieve communication between two threads.

### *Listing 13-16. Producing and Consuming Bytes via a Pipe*

```
import java.io.IOException;

import java.nio.ByteBuffer;

import java.nio.channels.Pipe;
import java.nio.channels.ReadableByteChannel;
import java.nio.channels.WritableByteChannel;

public class ChannelDemo
{
    final static int BUFSIZE = 10;
    final static int LIMIT = 3;

    public static void main(String[] args) throws IOException
    {
        final Pipe pipe = Pipe.open();
```

```

Runnable senderTask = new Runnable()
{
    @Override
    public void run()
    {
        WritableByteChannel src = pipe.sink();
        ByteBuffer buffer = ByteBuffer.allocate(BUFSIZE);
        for (int i = 0; i < LIMIT; i++)
        {
            buffer.clear();
            for (int j = 0; j < BUFSIZE; j++)
                buffer.put((byte) (Math.random() * 256));
            buffer.flip();
            try
            {
                while (src.write(buffer) > 0);
            }
            catch (IOException ioe)
            {
                System.err.println(ioe.getMessage());
            }
        }
        try
        {
            src.close();
        }
        catch (IOException ioe)
        {
        }
    }
};

Runnable receiverTask = new Runnable()
{
    @Override
    public void run()
    {
        ReadableByteChannel dst = pipe.source();
        ByteBuffer buffer = ByteBuffer.allocate(BUFSIZE);
        try
        {
            while (dst.read(buffer) >= 0)
            {
                buffer.flip();
                while (buffer.remaining() > 0)
                    System.out.println(buffer.get()&255);
                buffer.clear();
            }
        }
    }
}

```

```

        catch (IOException ioe)
        {
            System.err.println(ioe.getMessage());
        }
    }
};
Thread sender = new Thread(senderTask);
Thread receiver = new Thread(receiverTask);
sender.start();
receiver.start();
}
}

```

Listing 13-16's `main()` method first obtains a pipe and then creates sender and receiver tasks that serve as producer and consumer. `main()` then creates sender and receiver threads and starts them.

The sender task's `run()` method first obtains a writable byte channel from the pipe by invoking `Pipe`'s `sink()` method. It then allocates a byte buffer for storing content to be written.

`run()` continues by entering a pair of for loops for sending byte-oriented data to the writable byte channel. Each of the outer for loop iterations clears the buffer in preparation for filling by the inner for loop. The buffer is then flipped in preparation for draining, which is accomplished by passing the buffer to the writable byte channel's `write()` method. Because a single method call might not drain the entire buffer, `write()` is invoked in a loop until it returns 0, which means that there is no more content to write. The channel is then closed so that the receiver task doesn't block when reading from the channel because it expects to receive more data.

The receiver task's `run()` method first obtains a readable byte channel from the pipe by invoking `Pipe`'s `source()` method. It then allocates a buffer for storing read content.

Continuing, `run()` enters a while loop that continually reads from the channel until the `read()` method returns -1, which indicates that the channel has reached the end of the stream. This method wouldn't reach the end of the stream if the sender's `run()` method hadn't closed the channel.

At this point, the buffer is flipped to prepare it for draining. It's then drained by printing its byte values to the standard output stream. Each byte is bitwise ANDed with 255 to prevent a negative value from being output. Basically, `get()` returns an 8-bit integer value that's converted to a 32-bit integer during the `System.out.println()` method call. This conversion applies sign extension, which means that some byte values become negative 32-bit integers. By bitwise ANDing the byte value with 255, the conversion ensures that no byte value is turned into a negative 32-bit integer.

Finally, the buffer is cleared in preparation for filling and the loop continues.

---

Compile Listing 13-16 (`javac ChannelDemo.java`), and run the application (`java ChannelDemo`). You should observe a sequence of 30 random integers similar to the following:

---

```
245
56
137
166
52
183
252
166
246
124
163
11
159
68
203
118
157
70
54
148
186
17
12
203
75
223
224
175
205
47
```

---

## Working with Selectors

I/O is either block-oriented (such as file I/O) or stream-oriented (such as network I/O). Streams are often slower than block devices (such as fixed disks) and read/write operations often cause the calling thread to block until input is available or output has been fully written. To compensate, modern operating systems let streams operate in *nonblocking mode*, which makes it possible for a thread to read or write data without blocking. The operation fully succeeds, or it indicates that the read/write isn't possible at that time. Either way, the thread is able to perform other useful work instead of waiting.

Nonblocking mode doesn't let an application determine if it can perform an operation without actually performing the operation. For example, when a nonblocking read operation succeeds, the application learns that the read operation is possible but also has read some data that must be managed. This duality prevents you from separating code that checks for stream readiness from the data-processing code without making your code significantly complicated.



Nonblocking mode serves as a foundation for performing *readiness selection*, which offloads to the operating system the work involved in checking for I/O stream readiness to perform write, read, and other operations. The operating system is instructed to observe a group of streams and return some indication of which streams are ready to perform a specific operation (such as read) or operations (such as accept and read). This capability lets a thread *multiplex* a potentially huge number of active streams by using the readiness information provided by the operating system. In this way, network servers can handle large numbers of network connections; they are vastly scalable.

**Note** Modern operating systems make readiness selection available to applications by providing system calls such as the POSIX `select()` call.

Selectors let you achieve readiness selection in a Java context. In this section, I first introduce you to selector fundamentals and then provide a demonstration.

## Selector Fundamentals

A *selector* is an object created from a subclass of the abstract `java.nio.channels.Selector` class. It maintains a set of channels, which it examines to determine which of them are ready for reading, writing, completing a connection sequence, accepting another connection, or some combination of these tasks. The actual work is delegated to the operating system via a POSIX `select()` or similar system call.

**Note** The ability to check a channel without having to wait when something isn't ready (such as bytes are not available for reading) and without also having to perform the operation while checking is the key to scalability. A single thread can manage a huge number of channels, which reduces code complexity and potential threading issues.

Selectors are used with *selectable channels*, which are objects whose classes ultimately inherit from the abstract `SelectableChannel` class, which describes a channel that can be multiplexed by a selector. Socket channels, server socket channels, datagram channels, and pipe source/sink channels are selectable channels because `SocketChannel`, `ServerChannel`, `DatagramChannel`, `Pipe.SinkChannel`, and `Pipe.SourceChannel` are derived from `SelectableChannel`. In contrast, file channels are not selectable channels because `FileChannel` doesn't include `SelectableChannel` in its ancestry.

One or more previously created selectable channels are registered with a selector. Each registration returns a *key* (described by a concrete instance of the abstract `java.nio.channels.SelectionKey` class) that's a token signifying the relationship between one channel and the selector. This key keeps track of two sets of operations: interest set and ready set. The *interest set* identifies the operation categories that will be tested for readiness the next time one of the selector's selection methods is invoked. The *ready set* identifies the operation categories for which the key's channel has been found to be ready by the key's selector. When a selection method is invoked, the selector's associated keys are updated by checking all channels registered with that selector. The application

can then obtain a set of keys whose channels were found ready, and iterate over these keys to service each channel that has become ready since a previous select method call.

**Note** A selectable channel can be registered with more than one selector. It has no knowledge of the selectors to which it's currently registered.

To work with selectors, you first need to create one. You can accomplish this task by invoking Selector's `Selector.open()` class method. This method returns a `Selector` instance on success or throws `IOException` on failure. The following code fragment demonstrates this task:

```
Selector selector = Selector.open();
```

You can create your selectable channels before or after creating the selector. However, you must ensure that each channel is in nonblocking mode before registering the channel with the selector. You register a selectable channel with a selector by invoking either of the following `SelectableChannel` registration methods:

- `SelectionKey register(Selector sel, int ops)`
- `SelectionKey register(Selector sel, int ops, Object att)`

Each method requires that you pass a previously created selector to `sel` and a bitwise ORed combination of the following `SelectionKey` int-based constants to `ops`, which signifies the interest set:

- `OP_ACCEPT`: Operation-set bit for socket-accept operations.
- `OP_CONNECT`: Operation-set bit for socket-connect operations.
- `OP_READ`: Operation-set bit for read operations.
- `OP_WRITE`: Operation-set bit for write operations.

The second method also lets you pass an arbitrary `java.lang.Object`/subclass instance (or `null`) to `att`. The non-null object is known as an *attachment*, and it is a convenient way of recognizing a given channel or attaching additional information to the channel. It's stored in the `SelectionKey` instance returned from this method.

Upon success, each method returns a `SelectionKey` instance that relates the selectable channel with the selector. Upon failure, an exception is thrown. For example, `ClosedChannelException` is thrown when the channel is closed and `IllegalBlockingModeException` is thrown when the channel hasn't been set to nonblocking mode.

The following code fragment extends the previous code fragment by configuring a previously created channel to nonblocking mode and registering the channel with the selector, whose selection methods are to test the channel for accept, read, and write readiness:

```
channel.configureBlocking(false);
SelectionKey key = channel.register(selector, SelectionKey.OP_ACCEPT |
                                         SelectionKey.OP_READ |
                                         SelectionKey.OP_WRITE);
```

At this point, the application typically enters an infinite loop where it accomplishes the following tasks.

1. Performs a selection operation.
2. Obtains the selected keys followed by an iterator over the selected keys.
3. Iterates over these keys and perform channel operations.

A selection operation is performed by invoking one of `Selector`'s selection methods. For example, `int select()` performs a blocking selection operation. It doesn't return until at least one channel is selected, this selector's `wakeup()` method is invoked, or the current thread is interrupted, whichever comes first.

**Note** `Selector` also declares an `int select(long timeout)` method that doesn't return until at least one channel is selected, this selector's `wakeup()` method is invoked, the current thread is interrupted, or the timeout value expires, whichever comes first. Additionally, `Selector` declares `int selectNow()`, which is a nonblocking version of `select()`.

The `select()` method returns the number of channels that have become ready since the last time it was called. For example, if you call `select()` and it returns 1 because one channel has become ready, and if you call `select()` again and a second channel has become ready, `select()` will once again return 1. If you've not yet serviced the first ready channel, you now have two ready channels to service. However, only one channel became ready between these `select()` calls.

A set of the selected keys (the ready set) is now obtained by invoking `Selector`'s `Set<SelectionKey> selectedKeys()` method. Invoke the set's `iterator()` method to obtain an iterator over these keys.

Finally, the application iterates over the keys. For each of the iterations, a `SelectionKey` instance is returned. Some combination of `SelectionKey`'s `boolean isAcceptable()`, `boolean isConnectable()`, `boolean isReadable()`, and `boolean isWritable()` methods are called to determine if the key indicates that a channel is ready to accept a connection, finished connecting, readable, or writable.

**Note** The aforementioned methods offer a convenient alternative to specifying expressions such as `key.readyOps() & OP_READ != 0`. `SelectionKey`'s `int readyOps()` method returns the key's ready set. The returned set will only contain operation bits that are valid for this key's channel. For example, it never returns an operation bit that indicates that a read-only channel is ready for writing. Note that every selectable channel also declares an `int validOps()` method, which returns a bitwise ORed set of operations that are valid for the channel.

Once the application determines that a channel is ready to perform a specific operation, it can call `SelectionKey`'s `SelectableChannel channel()` method to obtain the channel and then perform work on that channel.

**Note** `SelectionKey` also declares a `Selector selector()` method that returns the selector for which the key was created.

When you're finished processing a channel, you must remove the key from the set of keys; the selector doesn't perform this task. The next time the channel becomes ready, the `Selector` will add the key to the selected key set.

The following code fragment continues from the previous code fragment and demonstrates the aforementioned tasks:

```
while (true)
{
    int numReadyChannels = selector.select();
    if (numReadyChannels == 0)
        continue; // there are no ready channels to process

    Set<SelectionKey> selectedKeys = selector.selectedKeys();
    Iterator<SelectionKey> keyIterator = selectedKeys.iterator();

    while (keyIterator.hasNext())
    {
        SelectionKey key = keyIterator.next();

        if (key.isAcceptable())
        {
            // A connection was accepted by a ServerSocketChannel.
            ServerSocketChannel server = (ServerSocketChannel) key.channel();
            SocketChannel client = server.accept();
            if (client == null) // in case accept() returns null
                continue;
            client.configureBlocking(false); // must be nonblocking
            // Register socket channel with selector for read operations.
            client.register(selector, SelectionKey.OP_READ);
        }
        else
            if (key.isReadable())
            {
                // A socket channel is ready for reading.
                SocketChannel client = (SocketChannel) key.channel();
                // Perform work on the socket channel.
            }
    }
}
```

```

else
if (key.isWritable())
{
    // A socket channel is ready for writing.
    SocketChannel client = (SocketChannel) key.channel();
    // Perform work on the socket channel.
}

keyIterator.remove();
}
}

```

In addition to registering the server socket channel with the selector, each incoming client socket channel is also registered with the server socket channel. When a client socket channel becomes ready for read or write operations, `key.isReadable()` or `key.isWritable()` for the associated socket channel returns true and the socket channel can be read or written.

A key represents a relationship between a selectable channel and a selector. This relationship can be terminated by invoking `SelectionKey`'s void `cancel()` method. Upon return, the key will be invalid and will have been added to its selector's cancelled-key set. The key will be removed from all of the selector's key sets during the next selection operation.

When you're finished with a selector, call `Selector`'s void `close()` method. If a thread is currently blocked in one of this selector's selection methods, it's interrupted as if by invoking the selector's `wakeup()` method. Any uncancelled keys still associated with this selector are invalidated, their channels are deregistered, and any other resources associated with this selector are released. If this selector is already closed, invoking `close()` has no effect.

## Selector Demonstration

Selectors are commonly used in server applications. Listing 13-17 presents the source code to a server application that sends its local time to clients.

*Listing 13-17. Serving Time to Clients*

```

import java.io.IOException;

import java.net.InetSocketAddress;
import java.net.ServerSocket;

import java.nio.ByteBuffer;

import java.nio.channels.SelectionKey;
import java.nio.channels.Selector;
import java.nio.channels.ServerSocketChannel;
import java.nio.channels.SocketChannel;

import java.util.Iterator;

```

```

public class SelectorServer
{
    final static int DEFAULT_PORT = 9999;

    static ByteBuffer bb = ByteBuffer.allocateDirect(8);

    public static void main(String[] args) throws IOException
    {
        int port = DEFAULT_PORT;
        if (args.length > 0)
            port = Integer.parseInt(args[0]);
        System.out.println("Server starting ... listening on port " + port);

        ServerSocketChannel ssc = ServerSocketChannel.open();
        ServerSocket ss = ssc.socket();
        ss.bind(new InetSocketAddress(port));
        ssc.configureBlocking(false);

        Selector s = Selector.open();
        ssc.register(s, SelectionKey.OP_ACCEPT);

        while (true)
        {
            int n = s.select();
            if (n == 0)
                continue;
            Iterator it = s.selectedKeys().iterator();
            while (it.hasNext())
            {
                SelectionKey key = (SelectionKey) it.next();
                if (key.isAcceptable())
                {
                    SocketChannel sc = ((ServerSocketChannel) key.channel()).accept();
                    if (sc == null)
                        continue;
                    System.out.println("Receiving connection");
                    bb.clear();
                    bb.putLong(System.currentTimeMillis());
                    bb.flip();
                    System.out.println("Writing current time");
                    while (bb.hasRemaining())
                        sc.write(bb);
                    sc.close();
                }
                it.remove();
            }
        }
    }
}

```

Listing 13-17's server application consists of a `SelectorServer` class. This class allocates a direct byte buffer after this class is loaded.

When the `main()` method is executed, it first checks for a command-line argument, which is assumed to represent a port number. If no argument is specified, a default port number is used; otherwise, `main()` tries to convert it to an integer representing the port by passing the argument to `Integer.parseInt()`. (Remember that this method throws `java.lang.NumberFormatException` when a noninteger argument is passed.)

After outputting a startup message that identifies the listening port, `main()` obtains a server socket channel followed by the underlying socket, which is bound to the specified port. The server socket channel is then configured for nonblocking mode in preparation for registering this channel with a selector.

A selector is now obtained and the server socket channel registers itself with the selector so that it can learn when the channel is ready to perform an accept operation. The returned key isn't saved because it's never canceled (and the selector is never closed).

`main()` now enters an infinite loop, first invoking the selector's `select()` method. If the server socket channel isn't ready (`select()` returns 0), the rest of the loop is skipped.

The selected keys (just one key) along with an iterator for iterating over them are now obtained and `main()` enters an inner loop to loop over these keys. Each key's `isAcceptable()` method is invoked to find out if the server socket channel is ready to perform an accept operation. If this is the case, the channel is obtained and cast to `ServerSocketChannel`, and `ServerSocketChannel`'s `accept()` method is called to accept the new connection.

To guard against the unlikely possibility of the returned `SocketChannel` instance being null (`accept()` returns null when the server socket channel is in nonblocking mode and no connection is available to be accepted), `main()` tests for this scenario and continues the loop when null is detected.

A message about receiving a connection is output, and the byte buffer is cleared in preparation for storing the local time. After this long integer has been stored in the buffer, the buffer is flipped in preparation for draining. A message about writing the current time is output and the buffer is drained. The socket channel is then closed and the key is removed from the set of keys.

Compile Listing 13-17 as follows:

```
javac SelectorServer.java
```

Run this application as follows:

```
java SelectorServer
```

You should observe the following output and the server should continue to run:

---

```
Server starting ... listening on port 9999
```

---

We need a client to exercise this server. Listing 13-18 presents the source code to a sample client application.

*Listing 13-18. Receiving Time from the Server*

```
import java.io.IOException;

import java.net.InetSocketAddress;

import java.nio.ByteBuffer;

import java.nio.channels.SocketChannel;

import java.util.Date;

public class SelectorClient
{
    final static int DEFAULT_PORT = 9999;

    static ByteBuffer bb = ByteBuffer.allocateDirect(8);

    public static void main(String[] args)
    {
        int port = DEFAULT_PORT;
        if (args.length > 0)
            port = Integer.parseInt(args[0]);

        try
        {
            SocketChannel sc = SocketChannel.open();
            InetSocketAddress addr = new InetSocketAddress("localhost", port);
            sc.connect(addr);

            long time = 0;
            while (sc.read(bb) != -1)
            {
                bb.flip();
                while (bb.hasRemaining())
                {
                    time <<= 8;
                    time |= bb.get() & 255;
                }
                bb.clear();
            }
            System.out.println(new Date(time));

            sc.close();
        }
        catch (IOException ioe)
        {
            System.err.println("I/O error: " + ioe.getMessage());
        }
    }
}
```



Listing 13-18 is much simpler than Listing 13-17 because selectors aren't used. There's no need for a selector in this simple application. You would typically use selectors in a client context when the client interacts with several servers.

There are a couple of interesting items in the source code:

- `bb.get()` returns a 32-bit integer representation of an 8-bit byte. Sign extension is used for byte values greater than 127, which are regarded as negative numbers. Because leading one bits affect the result after bitwise ORing them with `time`, they are removed by bitwise ANDing the integer with 255.
- This value in `time` is passed to the `java.util.Date(long time)` constructor when a new `Date` object is constructed. In turn, the `Date` object is passed to `System.out.println()`, which invokes `Date`'s `toString()` method to obtain a human-readable date/time string. (I discuss `Date` in Chapter 16.)

Compile Listing 13-18 as follows:

```
javac SelectorClient.java
```

In a second command window, run this application as follows:

```
java SelectorClient
```

You should observe output similar to the following:

---

```
Mon Jan 13 18:48:10 CST 2014
```

---

In the server command window, you should observe the following messages:

---

```
Receiving connection  
Writing current time
```

---

## Working with Regular Expressions

Text-processing applications often need to match text against *patterns* (character strings that concisely describe sets of strings that are considered to be matches). For example, an application might need to locate all occurrences of a specific word pattern in a text file so that it can replace those occurrences with another word. NIO includes regular expressions to help text-processing applications perform pattern matching with high performance.

## Pattern, PatternSyntaxException, and Matcher

A *regular expression* (also known as a *regex* or *regexp*) is a string-based pattern that represents the set of strings that match this pattern. The pattern consists of literal characters and *metacharacters*, which are characters with special meanings instead of literal meanings.

The Regular Expressions API provides the `java.util.regex.Pattern` class to represent patterns via compiled regexes. Regexes are compiled for performance reasons; pattern matching via compiled regexes is much faster than if the regexes were not compiled. Table 13-3 describes `Pattern`'s methods.

**Table 13-3. Pattern Methods**

Method	Description
<code>static Pattern compile(String regex)</code>	Compiles regex and returns its <code>Pattern</code> object. This method throws <code>java.util.regex.PatternSyntaxException</code> when regex's syntax is invalid.
<code>static Pattern compile(String regex, int flags)</code>	Compiles regex according to the given flags (a bitset consisting of some combination of <code>Pattern</code> 's <code>CANON_EQ</code> , <code>CASE_INSENSITIVE</code> , <code>COMMENTS</code> , <code>DOTALL</code> , <code>LITERAL</code> , <code>MULTILINE</code> , <code>UNICODE_CASE</code> , and <code>UNIX_LINES</code> constants) and returns its <code>Pattern</code> object. This method throws <code>PatternSyntaxException</code> when regex's syntax is invalid, and throws <code>IllegalArgumentException</code> when bit values other than those corresponding to the defined match flags are set in flags.
<code>int flags()</code>	Returns this <code>Pattern</code> object's match flags. This method returns 0 for <code>Pattern</code> instances created via <code>compile(String)</code> and the bitset of flags for <code>Pattern</code> instances created via <code>compile(String, int)</code> .
<code>Matcher matcher(CharSequence input)</code>	Returns a <code>java.util.regex.Matcher</code> that will match input against this <code>Pattern</code> 's compiled regex.
<code>static boolean matches(String regex, CharSequence input)</code>	Compiles regex and attempts to match input against the compiled regex. Returns true when there is a match; otherwise, returns false. This convenience method is equivalent to <code>Pattern.compile(regex).matcher(input).matches()</code> and throws <code>PatternSyntaxException</code> when regex's syntax is invalid.
<code>String pattern()</code>	Returns this <code>Pattern</code> 's uncompiled regex.
<code>static String quote(String s)</code>	Quotes <code>s</code> using <code>"\Q"</code> and <code>"\E"</code> so that all other metacharacters lose their special meaning. When the returned <code>java.lang.String</code> object is later compiled into a <code>Pattern</code> instance, it only can be matched literally.
<code>String[] split(CharSequence input)</code>	Splits <code>input</code> around matches of this <code>Pattern</code> 's compiled regex and returns an array containing the matches.
<code>String[] split(CharSequence input, int limit)</code>	Splits <code>input</code> around matches of this <code>Pattern</code> 's compiled regex; <code>limit</code> controls the number of times the compiled regex is applied and thus affects the length of the resulting array.
<code>String toString()</code>	Returns this <code>Pattern</code> 's uncompiled regex.

Table 13-3 reveals the `java.lang.CharSequence` interface, which describes a readable and immutable sequence of `char` values; the underlying implementation may be mutable. Instances of any class that implements this interface (such as `String`, `java.lang.StringBuffer`, and `java.lang.StringBuilder`) can be passed to `Pattern` methods that take `CharSequence` arguments (such as `split(CharSequence)`).

Table 13-3 also reveals that each of Pattern's `compile()` methods and its `matches()` method (which calls the `compile(String)` method) throws `PatternSyntaxException` when a syntax error is encountered while compiling the pattern argument. Table 13-4 describes `PatternSyntaxException`'s methods.

**Table 13-4.** *PatternSyntaxException Methods*

Method	Description
<code>String getDescription()</code>	Returns a description of the syntax error.
<code>int getIndex()</code>	Returns the approximate index of where the syntax error occurred in the pattern or -1 when the index isn't known.
<code>String getMessage()</code>	Returns a multiline string containing the description of the syntax error and its index, the erroneous pattern, and a visual indication of the error index within the pattern.
<code>String getPattern()</code>	Returns the erroneous pattern.

Finally, Table 13-4's `Matcher matcher(CharSequence input)` method reveals that the Regular Expressions API also provides the `Matcher` class, whose *matchers* attempt to match compiled regexes against input text. `Matcher` declares the following methods to perform matching operations:

- `boolean matches()`: Attempts to match the entire region against the pattern. When the match succeeds, more information can be obtained by calling `Matcher`'s `start()`, `end()`, and `group()` methods. For example, `int start()` returns the start index of the previous match, `int end()` returns the offset of the first character following the previous match, and `String group()` returns the input subsequence matched by the previous match. Each method throws `java.lang.IllegalStateException` when a match has not yet been attempted or the previous match attempt failed.
- `boolean lookingAt()`: Attempts to match the input sequence, starting at the beginning of the region, against the pattern. As with `matches()`, this method always starts at the beginning of the region. Unlike `matches()`, `lookingAt()` doesn't require that the entire region be matched. When the match succeeds, more information can be obtained by calling `Matcher`'s `start()`, `end()`, and `group()` methods.
- `boolean find()`: Attempts to find the next subsequence of the input sequence that matches the pattern. It starts at the beginning of this `matcher`'s region, or, if a previous call to this method was successful and the `matcher` hasn't since been reset (by calling `Matcher`'s `Matcher reset()` or `Matcher reset(CharSequence input)` method), at the first character not matched by the previous match. When the match succeeds, more information can be obtained by calling `Matcher`'s `start()`, `end()`, and `group()` methods.

**Note** A matcher finds matches in a subset of its input called the *region*. By default, the region contains all of the matcher's input. The region can be modified by calling `Matcher`'s `Matcher region(int start, int end)` method (set the limits of this matcher's region) and queried by calling `Matcher`'s `int regionStart()` and `int regionEnd()` methods.

I've created a simple application that demonstrates `Pattern`, `PatternSyntaxException`, and `Matcher`. Listing 13-19 presents this application's source code.

*Listing 13-19. Playing with Regular Expressions*

```
import java.util.regex.Matcher;
import java.util.regex.Pattern;
import java.util.regex.PatternSyntaxException;

public class RegExDemo
{
    public static void main(String[] args)
    {
        if (args.length != 2)
        {
            System.err.println("usage: java RegExDemo regex input");
            return;
        }
        try
        {
            System.out.println("regex = " + args[0]);
            System.out.println("input = " + args[1]);
            Pattern p = Pattern.compile(args[0]);
            Matcher m = p.matcher(args[1]);
            while (m.find())
                System.out.println("Located [" + m.group() + "] starting at "
                    + m.start() + " and ending at " + (m.end() - 1));
        }
        catch (PatternSyntaxException pse)
        {
            System.err.println("Bad regex: " + pse.getMessage());
            System.err.println("Description: " + pse.getDescription());
            System.err.println("Index: " + pse.getIndex());
            System.err.println("Incorrect pattern: " + pse.getPattern());
        }
    }
}
```

Compile Listing 13-19 as follows:

```
javac RegExDemo.java
```

Run this application as follows:

```
java RegExDemo ox ox
```

You'll discover the following output:

---

```
regex = ox
input = ox
Located [ox] starting at 0 and ending at 1
```

---

`find()` searches for a match by comparing regex characters with the input characters in left-to-right order and returns true because o equals o and x equals x.

Continue by executing the following command:

```
java RegExDemo box ox
```

This time, you'll discover the following output:

---

```
regex = box
input = ox
```

---

`find()` first compares regex character b with input character o. Because these characters are not equal and because there are not enough characters in the input to continue the search, `find()` doesn't output a "Located" message to indicate a match.

However, if you execute `java RegExDemo ox box`, you'll discover a match:

---

```
regex = ox
input = box
Located [ox] starting at 1 and ending at 2
```

---

The `ox` regex consists of literal characters. More sophisticated regexes combine literal characters with *metacharacters* (such as the period `[.]`) and other regex constructs.

**Tip** To specify a metacharacter as a literal character, precede the metacharacter with a backslash character (as in `\.`) or place the metacharacter between `\Q` and `\E` (as in `\Q.\E`). In either case, make sure to double the backslash character when the escaped metacharacter appears in a string literal, such as `"\\."` or `"\\Q\\.\\E"`.

The period metacharacter matches all characters except for the line terminator. For example, each of `java RegExDemo .ox box` and `java RegExDemo .ox fox` report a match because the period matches the b in box and the f in fox.

**Note** Pattern recognizes the following line terminators: carriage return (`\r`), newline (line feed) (`\n`), carriage return immediately followed by newline (`\r\n`), next line (`\u0085`), line separator (`\u2028`), and paragraph separator (`\u2029`). The period metacharacter can also be made to match these line terminators by specifying the `Pattern.DOTALL` flag when calling `Pattern.compile(String, int)`.

## Character Classes

A *character class* is a set of characters appearing between `[` and `]`. There are six kinds of character classes:

- A *simple character class* consists of literal characters placed side by side and matches only these characters. For example, `[abc]` consists of characters `a`, `b`, and `c`. Also, `java RegExDemo t[aiou]ck tack` reports a match because `a` is a member of `[aiou]`. It also reports a match when the input is `tick`, `tock`, or `tuck` because `i`, `o`, and `u` are members.
- A *negation character class* consists of a circumflex metacharacter (`^`), followed by literal characters placed side by side, and it matches all characters except for those in the class. For example, `[^abc]` consists of all characters except for `a`, `b`, and `c`. Also, `java RegExDemo "[^b]ox" box` doesn't report a match because `b` isn't a member of `[^b]`, whereas `java RegExDemo "[^b]ox" fox` reports a match because `f` is a member. (The double quotes surrounding `[^b]ox` are necessary on my Windows 7 platform because `^` is treated specially at the command line.)
- A *range character class* consists of successive literal characters expressed as a starting literal character, followed by the hyphen metacharacter (`-`), followed by an ending literal character, and matches all characters in this range. For example, `[a-z]` consists of all characters from `a` through `z`. Also, `java RegExDemo [h-l]ouse house` reports a match because `h` is a member of the class, whereas `java RegExDemo [h-l]ouse mouse` doesn't report a match because `m` lies outside of the range and is therefore not part of the class. You can combine multiple ranges within the same range character class by placing them side by side; for example, `[A-Za-z]` consists of all uppercase and lowercase Latin letters.
- A *union character class* consists of multiple nested character classes and matches all characters that belong to the resulting union. For example, `[abc[u-z]]` consists of characters `a`, `b`, `c`, `u`, `v`, `w`, `x`, `y`, and `z`. Also, `java RegExDemo [[0-9][A-F][a-f]] e` reports a match because `e` is a hexadecimal character. (I could have alternatively expressed this character class as `[0-9A-Fa-f]` by combining multiple ranges.)
- An *intersection character class* consists of multiple `&&`-separated nested character classes and matches all characters that are common to these nested character classes. For example, `[a-c&&[c-f]]` consists of character `c`, which is the only character common to `[a-c]` and `[c-f]`. Also, `java RegExDemo "[aeiouy&&[y]]" y` reports a match because `y` is common to classes `[aeiouy]` and `[y]`.

- A *subtraction character class* consists of multiple &&-separated nested character classes, where at least one nested character class is a negation character class, and it matches all characters except for those indicated by the negation character class/classes. For example, `[a-z&&[^x-z]]` consists of characters a through w. (The square brackets surrounding `^x-z` are necessary; otherwise, `^` is ignored and the resulting class consists of only x, y, and z.) Also, `java RegExDemo "[a-z&&[^aeiou]]" g` reports a match because g is a consonant and only consonants belong to this class. (I'm ignoring y, which is sometimes regarded as a consonant and sometimes regarded as a vowel.)

A *predefined character class* is a regex construct for a commonly specified character class. Table 13-5 identifies Pattern's predefined character classes.

**Table 13-5. Predefined Character Classes**

Predefined Character Class	Description
<code>\d</code>	Matches any digit character. <code>\d</code> is equivalent to <code>[0-9]</code> .
<code>\D</code>	Matches any nondigit character. <code>\D</code> is equivalent to <code>[^\d]</code> .
<code>\s</code>	Matches any whitespace character. <code>\s</code> is equivalent to <code>[\t\n\x0B\f\r ]</code> .
<code>\S</code>	Matches any nonwhitespace character. <code>\S</code> is equivalent to <code>[^\s]</code> .
<code>\w</code>	Matches any word character. <code>\w</code> is equivalent to <code>[a-zA-Z0-9]</code> .
<code>\W</code>	Matches any nonword character. <code>\W</code> is equivalent to <code>[^\w]</code> .

For example, the following command reports a match because `\w` matches the word character a in abc:

```
java RegExDemo \wbc abc
```

## Capturing Groups

A *capturing group* saves a match's characters for later recall during pattern matching and is expressed as a character sequence surrounded by parentheses metacharacters ( and ). All characters within a capturing group are treated as a unit. For example, the `(Android)` capturing group combines A, n, d, r, o, i, and d into a unit. It matches the `Android` pattern against all occurrences of `Android` in the input. Each match replaces the previous match's saved `Android` characters with the next match's `Android` characters.

Capturing groups can appear inside other capturing groups. For example, capturing groups (A) and (B(C)) appear inside capturing group ((A)(B(C))), and capturing group (C) appears inside capturing group (B(C)). Each nested or nonnested capturing group receives its own number, numbering starts at 1, and capturing groups are numbered from left to right. For example, ((A)(B(C))) is assigned 1, (A) is assigned 2, (B(C)) is assigned 3, and (C) is assigned 4.

A capturing group saves its match for later recall via a *back reference*, which is a backslash character followed by a digit character denoting a capturing group number. The back reference causes the matcher to use the back reference's capturing group number to recall the capturing group's saved match and then use that match's characters to attempt a further match. The following example uses a back reference to determine if the input consists of two consecutive Android patterns:

```
java RegExDemo "(Android) \1" "Android Android"
```

RegExDemo reports a match because the matcher detects Android, followed by a space, followed by Android in the input.

## Boundary Matchers and Zero-Length Matches

A *boundary matcher* is a regex construct for identifying the beginning of a line, a word boundary, the end of text, and other commonly occurring boundaries. See Table 13-6.

**Table 13-6.** Boundary Matchers

Boundary Matcher	Description
<code>^</code>	Matches the beginning of the line.
<code>\$</code>	Matches the end of the line.
<code>\b</code>	Matches a word boundary.
<code>\B</code>	Matches a nonword boundary.
<code>\A</code>	Matches the beginning of text.
<code>\G</code>	Matches the end of the previous match.
<code>\Z</code>	Matches the end of text except for line terminator (when present).
<code>\z</code>	Matches the end of text.

Consider the following example:

```
java RegExDemo "\b\b" "I think"
```

This example reports several matches, as revealed in the following output:

---

```
regex = \b\b
input = I think
Located [] starting at 0 and ending at -1
Located [] starting at 1 and ending at 0
Located [] starting at 2 and ending at 1
Located [] starting at 7 and ending at 6
```

---



This output reveals several *zero-length matches*. When a zero-length match occurs, the starting and ending indexes are equal, although the output shows the ending index to be one less than the starting index because I specified `end() - 1` in Listing 13-19 (so that a match's end index identifies a non-zero-length match's last character, not the character following the non-zero-length match's last character).

**Note** A zero-length match occurs in empty input text, at the beginning of input text, after the last character of input text, or between any two characters of that text. Zero-length matches are easy to identify because they always start and end at the same index position.

## Quantifiers

The final regex construct I present is the *quantifier*, a numeric value implicitly or explicitly bound to a pattern. Quantifiers are categorized as greedy, reluctant, or possessive:

- A *greedy quantifier* (`?`, `*`, or `+`) attempts to find the longest match. Specify `X?` to find one or no occurrences of `X`; `X*` to find zero or more occurrences of `X`; `X+` to find one or more occurrences of `X`; `X{n}` to find `n` occurrences of `X`; `X{n,}` to find at least `n` (and possibly more) occurrences of `X`; and `X{n,m}` to find at least `n` but no more than `m` occurrences of `X`.
- A *reluctant quantifier* (`??`, `*?`, or `+`) attempts to find the shortest match. Specify `X??` to find one or no occurrences of `X`; `X*?` to find zero or more occurrences of `X`; `X+?` to find one or more occurrences of `X`; `X{n}?` to find `n` occurrences of `X`; `X{n,}?` to find at least `n` (and possibly more) occurrences of `X`; and `X{n,m}?` to find at least `n` but no more than `m` occurrences of `X`.
- A *possessive quantifier* (`?+`, `*+`, or `++`) is similar to a greedy quantifier except that a possessive quantifier only makes one attempt to find the longest match, whereas a greedy quantifier can make multiple attempts. Specify `X?+` to find one or no occurrences of `X`; `X*+` to find zero or more occurrences of `X`; `X++` to find one or more occurrences of `X`; `X{n}+` to find `n` occurrences of `X`; `X{n,}+` to find at least `n` (and possibly more) occurrences of `X`; and `X{n,m}+` to find at least `n` but no more than `m` occurrences of `X`.

For an example of a greedy quantifier, execute the following command:

```
java RegExDemo .*end "wend rend end"
```

You'll discover the following output:

---

```
regex = .*end
input = wend rend end
Located [wend rend end] starting at 0 and ending at 12
```

---

The greedy quantifier (`.*`) matches the longest sequence of characters that terminates in `end`. It starts by consuming all of the input text and then is forced to back off until it discovers that the input text terminates with these characters.

For an example of a reluctant quantifier, execute the following command:

```
java RegExDemo .*?end "wend rend end"
```

You'll discover the following output:

---

```
regex = .*?end
input = wend rend end
Located [wend] starting at 0 and ending at 3
Located [ rend] starting at 4 and ending at 8
Located [ end] starting at 9 and ending at 12
```

---

The reluctant quantifier (`.?*?`) matches the shortest sequence of characters that terminates in `end`. It begins by consuming nothing and then slowly consumes characters until it finds a match. It then continues until it exhausts the input text.

For an example of a possessive quantifier, execute the following command:

```
java RegExDemo .*+end "wend rend end"
```

You'll discover the following output:

---

```
regex = .*+end
input = wend rend end
```

---

The possessive quantifier (`.?*+`) doesn't detect a match because it consumes the entire input text, leaving nothing left over to match `end` at the end of the regex. Unlike a greedy quantifier, a possessive quantifier doesn't back off.

While working with quantifiers, you'll probably encounter zero-length matches. For example, execute the following command:

```
java RegExDemo 1? 101101
```

You should observe the following output:

---

```
regex = 1?
input = 101101
Located [1] starting at 0 and ending at 0
Located [] starting at 1 and ending at 0
Located [1] starting at 2 and ending at 2
Located [1] starting at 3 and ending at 3
Located [] starting at 4 and ending at 3
Located [1] starting at 5 and ending at 5
Located [] starting at 6 and ending at 5
```

---

The result of this greedy quantifier is that 1 is detected at locations 0, 2, 3, and 5 in the input text, and that nothing is detected (a zero-length match) at locations 1, 4, and 6.

This time, execute the following command:

```
java RegExDemo 1?? 101101
```

You should observe the following output:

---

```
regex = 1??
input = 101101
Located [] starting at 0 and ending at -1
Located [] starting at 1 and ending at 0
Located [] starting at 2 and ending at 1
Located [] starting at 3 and ending at 2
Located [] starting at 4 and ending at 3
Located [] starting at 5 and ending at 4
Located [] starting at 6 and ending at 5
```

---

This output might look surprising, but remember that a reluctant quantifier looks for the shortest match, which (in this case) is no match at all.

Finally, execute the following command:

```
java RegExDemo 1+? 101101
```

You should observe the following output:

---

```
regex = 1+?
input = 101101
Located [1] starting at 0 and ending at 0
Located [1] starting at 2 and ending at 2
Located [1] starting at 3 and ending at 3
Located [1] starting at 5 and ending at 5
```

---

This possessive quantifier only matches the locations where 1 is detected in the input text. It doesn't perform zero-length matches.

**Note** Check out the Java documentation on the `Pattern` class to learn about additional regex constructs.

## Practical Regular Expressions

Most of the previous regex examples haven't been practical, except to help you grasp how to use the various regex constructs. In contrast, the following examples reveal a regex that matches phone numbers of the form (ddd) ddd-dddd or ddd-dddd. A single space appears between (ddd) and ddd; there's no space on either side of the hyphen.

```
java RegExDemo "(\\d{3}\\s)?\\s*\\d{3}-\\d{4}" "(800) 555-1212"
regex = (\\d{3}\\s)?\\s*\\d{3}-\\d{4}
input = (800) 555-1212
Located [(800) 555-1212] starting at 0 and ending at 13
```

```
java RegExDemo "(\\d{3}\\s)?\\s*\\d{3}-\\d{4}" "555-1212"
regex = (\\d{3}\\s)?\\s*\\d{3}-\\d{4}
input = 555-1212
Located [555-1212] starting at 0 and ending at 7
```

**Note** To learn more about regular expressions, check out “Lesson: Regular Expressions” (<http://download.oracle.com/javase/tutorial/essential/regex/index.html>) in The Java Tutorials.

## Working with Charsets

In Chapter 11, I briefly introduced the concepts of character set and character encoding. I also referred to some of the types located in the `java.nio.charset` package. In this section, I expand on these topics and explore this package in more detail. I also briefly revisit the `String` class, discussing that part of `String` that's relevant to the discussion.

## A Brief Review of the Fundamentals

Java uses Unicode to represent characters. (*Unicode* is a 16-bit character set standard [actually, more of an encoding standard because some characters are represented by multiple numeric values; each value is known as a *code point*] whose goal is to map all of the world's significant character sets into an all-encompassing mapping). Although Unicode makes it much easier to work with characters from different languages, it doesn't automate everything and you often need to work with charsets. Before I dig into this topic, you should understand the following terms:

- *Character*: A meaningful symbol. For example, “\$” and “E” are characters. These symbols predate the computer era.
- *Character set*: A set of characters. For example, uppercase letters A through Z could be considered to form a character set. No numeric values are assigned to the characters in the set. There is no relationship to Unicode, ASCII, EBCDIC, or any other kind of character set standard.
- *Coded character set*: A character set where each character is assigned a unique numeric value. Standards bodies such as US-ASCII or ISO-8859-1 define mappings from characters to numeric values.

- *Character-encoding scheme*: An encoding of a coded character set's numeric values to sequences of bytes that represent these values. Some encodings are one-to-one. For example, in ASCII, character A is mapped to integer 65 and encoded as integer 65. For some other mappings, encodings are one-to-one or one-to-many. For example, UTF-8 encodes Unicode characters. Each character whose numeric value is less than 128 is encoded as a single byte to be compatible with ASCII. Other Unicode characters are encoded as 2-to-6-byte sequences. See [www.ietf.org/rfc/rfc2279.txt](http://www.ietf.org/rfc/rfc2279.txt) for more information.
- *Charset*: A coded character set combined with a character-encoding scheme. Charsets are described by the abstract `java.nio.charset.CharSet` class.

Although Unicode is widely used and increasing in popularity, other character set standards are also used. Because operating systems perform I/O at the byte level, and because files store data as byte sequences, it's necessary to translate between byte sequences and the characters that are encoded into these sequences. Charset and the other classes located in the `java.nio.charset` package address this translation task.

## Working with Charsets

Beginning with JDK 1.4, virtual machines were required to support a standard collection of charsets and could support additional charsets. They also support the default charset, which doesn't have to be one of the standard charsets and is obtained when the virtual machine starts running. Table 13-7 identifies and describes the standard charsets.

**Table 13-7. Standard Charsets**

Charset Name	Description
US-ASCII	The 7-bit ASCII that forms the American English character set. Also known as the basic Latin block in Unicode.
ISO-8859-1	The 8-bit character set used by most European languages. It's a superset of ASCII and includes most non-English European characters.
UTF-8	An 8-bit byte-oriented character encoding for Unicode. Characters are encoded in 1 to 6 bytes.
UTF-16BE	A 16-bit encoding using big-endian order for Unicode. Characters are encoded in 2 bytes with the high-order 8 bits written first.
UTF-16LE	A 16-bit encoding using little-endian order for Unicode. Characters are encoded in 2 bytes with the low-order 8 bits written first.
UTF-16	A 16-bit encoding whose endian order is determined by an optional byte-order mark.

Charset names are case-insensitive and are maintained by the Internet Assigned Names Authority (IANA). The names in Table 13-7 are included in IANA's official registry.

UTF-16BE and UTF-16LE encode each character as a 2-byte sequence in big-endian or little-endian order, respectively. A decoder for a UTF-16BE- or UTF-16LE-encoded byte sequence needs to know how the byte sequence was encoded. In contrast, UTF-16 relies on a *byte order mark* that appears at the beginning of the sequence. If this mark is absent, decoding proceeds according to UTF-16BE

(Java's native byte order). If this mark equals `\uFEFF`, the sequence is decoded according to UTF-16BE. If this mark equals `\uFFFE`, the sequence is decoded according to UTF-16LE.

Each charset name is associated with a `Charset` object, which you obtain by invoking one of this class's factory methods. Listing 13-20 presents an application that shows you how to use this class to obtain the default and standard charsets, which are then used to encode characters into byte sequences.

*Listing 13-20. Using Charsets to Encode Characters into Byte Sequences*

```
import java.nio.ByteBuffer;

import java.nio.charset.Charset;

public class CharsetDemo
{
    public static void main(String[] args)
    {
        String msg = "façade touché";
        String[] csNames =
        {
            "US-ASCII",
            "ISO-8859-1",
            "UTF-8",
            "UTF-16BE",
            "UTF-16LE",
            "UTF-16"
        };

        encode(msg, Charset.defaultCharset());
        for (String csName: csNames)
            encode(msg, Charset.forName(csName));
    }

    static void encode(String msg, Charset cs)
    {
        System.out.println("Charset: " + cs.toString());
        System.out.println("Message: " + msg);

        ByteBuffer buffer = cs.encode(msg);
        System.out.println("Encoded: ");

        for (int i = 0; buffer.hasRemaining(); i++)
        {
            int _byte = buffer.get() & 255;
            char ch = (char) _byte;
            if (Character.isWhitespace(ch) || Character.isISOControl(ch))
                ch = '\u0000';
            System.out.printf("%2d: %02x (%c)%n", i, _byte, ch);
        }
        System.out.println();
    }
}
```

Listing 13-20's `main()` method first creates a message consisting of two French words and an array of names for the standard collection of charsets. Next, it invokes the `encode()` method to encode the message according to the default charset, which it obtains by calling `Charset's Charset defaultCharset()` factory method. Continuing, `main()` invokes `encode()` for each of the standard charsets. `Charset's Charset forName(String charsetName)` factory method is used to obtain the `Charset` instance that corresponds to `charsetName`.

**Caution** `forName()` throws `java.nio.charset.IllegalCharsetNameException` when the specified charset name is illegal and throws `java.nio.charset.UnsupportedCharsetException` when the desired charset isn't supported by the virtual machine.

The `encode()` method first identifies the charset and the message. It then invokes `Charset's ByteBuffer encode(String s)` method to return a new `ByteBuffer` object containing the bytes that encode the characters from `s`.

`main()` next iterates over the bytes in the byte buffer, converting each byte to a character. It uses `java.lang.Character's isWhitespace()` and `isISOControl()` methods to determine if the character is whitespace or a control character (neither is regarded as printable) and converts such a character to Unicode 0 (empty string). (A carriage return or newline would screw up the output, for example.)

Finally, the index of the character, its hexadecimal value, and the character itself are printed to the standard output stream. I chose to use `System.out.printf()` for this task. You'll learn about this method in the next section.

Compile Listing 13-20 as follows:

```
javac CharsetDemo.java
```

Run the application as follows:

```
java CharsetDemo
```

You should observe the following output:

---

```
Charset: windows-1252
Message: façade touché
Encoded:
0: 66 (f)
1: 61 (a)
2: e7 (ç)
3: 61 (a)
4: 64 (d)
5: 65 (e)
6: 20 ( )
7: 74 (t)
8: 6f (o)
```

9: 75 (u)  
10: 63 (c)  
11: 68 (h)  
12: e9 (é)

Charset: US-ASCII  
Message: façade touché  
Encoded:

0: 66 (f)  
1: 61 (a)  
2: 3f (?)  
3: 61 (a)  
4: 64 (d)  
5: 65 (e)  
6: 20 ( )  
7: 74 (t)  
8: 6f (o)  
9: 75 (u)  
10: 63 (c)  
11: 68 (h)  
12: 3f (?)

Charset: ISO-8859-1  
Message: façade touché  
Encoded:

0: 66 (f)  
1: 61 (a)  
2: e7 (ç)  
3: 61 (a)  
4: 64 (d)  
5: 65 (e)  
6: 20 ( )  
7: 74 (t)  
8: 6f (o)  
9: 75 (u)  
10: 63 (c)  
11: 68 (h)  
12: e9 (é)

Charset: UTF-8  
Message: façade touché  
Encoded:

0: 66 (f)  
1: 61 (a)  
2: c3 (Ã)  
3: a7 (§)  
4: 61 (a)  
5: 64 (d)  
6: 65 (e)  
7: 20 ( )  
8: 74 (t)  
9: 6f (o)



10: 75 (u)  
11: 63 (c)  
12: 68 (h)  
13: c3 (Ã)  
14: a9 (©)

Charset: UTF-16BE  
Message: façade touché  
Encoded:

0: 00 ( )  
1: 66 (f)  
2: 00 ( )  
3: 61 (a)  
4: 00 ( )  
5: e7 (ç)  
6: 00 ( )  
7: 61 (a)  
8: 00 ( )  
9: 64 (d)  
10: 00 ( )  
11: 65 (e)  
12: 00 ( )  
13: 20 ( )  
14: 00 ( )  
15: 74 (t)  
16: 00 ( )  
17: 6f (o)  
18: 00 ( )  
19: 75 (u)  
20: 00 ( )  
21: 63 (c)  
22: 00 ( )  
23: 68 (h)  
24: 00 ( )  
25: e9 (é)

Charset: UTF-16LE  
Message: façade touché  
Encoded:

0: 66 (f)  
1: 00 ( )  
2: 61 (a)  
3: 00 ( )  
4: e7 (ç)  
5: 00 ( )  
6: 61 (a)  
7: 00 ( )  
8: 64 (d)  
9: 00 ( )  
10: 65 (e)  
11: 00 ( )  
12: 20 ( )

```
13: 00 ( )
14: 74 (t)
15: 00 ( )
16: 6f (o)
17: 00 ( )
18: 75 (u)
19: 00 ( )
20: 63 (c)
21: 00 ( )
22: 68 (h)
23: 00 ( )
24: e9 (é)
25: 00 ( )
```

Charset: UTF-16

Message: façade touché

Encoded:

```
0: fe (þ)
1: ff (ÿ)
2: 00 ( )
3: 66 (f)
4: 00 ( )
5: 61 (a)
6: 00 ( )
7: e7 (ç)
8: 00 ( )
9: 61 (a)
10: 00 ( )
11: 64 (d)
12: 00 ( )
13: 65 (e)
14: 00 ( )
15: 20 ( )
16: 00 ( )
17: 74 (t)
18: 00 ( )
19: 6f (o)
20: 00 ( )
21: 75 (u)
22: 00 ( )
23: 63 (c)
24: 00 ( )
25: 68 (h)
26: 00 ( )
27: e9 (é)
```

---

In addition to providing encoding methods such as the aforementioned `ByteBuffer encode(String s)` method, `Charset` provides a complementary `CharBuffer decode(ByteBuffer buffer)` decoding method. The return type is `CharBuffer` because byte sequences are decoded into characters.

**Note** `ByteBuffer encode(String s)` is a convenience method for specifying `CharBuffer.wrap(s)` and passing the result to the `ByteBuffer encode(CharBuffer buffer)` method.

If you dig deeper into `Charset`, you'll encounter the following pair of methods:

- `CharsetEncoder newEncoder()`
- `CharsetDecoder newDecoder()`

These methods perform the actual work of encoding and decoding. `Charset`'s `encode()` and `decode()` methods delegate to the `java.nio.charset.CharsetEncoder` and `java.nio.charset.CharsetDecoder` objects returned from `newEncoder()` and `newDecoder()` and invoke their `encode()` and `decode()` (along with additional) methods. (For brevity, I don't discuss `CharsetEncoder` and `CharsetDecoder`.)

## Charsets and the String Class

The `String` class describes a string as a sequence of characters. It declares constructors that can be passed byte arrays. Because a byte array contains an encoded character sequence, a charset is required to decode them. The following is a partial list of `String` constructors that work with charsets:

- `String(byte[] data)`: Constructs a new `String` instance by decoding the specified array of bytes using the platform's default charset.
- `String(byte[] data, int offset, int byteCount)`: Constructs a new `String` instance by decoding the specified subsequence of the byte array using the platform's default charset.
- `String(byte[] data, String charsetName)`: Constructs a new `String` instance by decoding the specified array of bytes using the named charset.

Furthermore, `String` declares methods that encode its sequence of characters into a byte array with help from the default charset or a named charset. Two of these methods are the following:

- `byte[] getBytes()`: Returns a new byte array containing the characters of this string encoded using the platform's default charset.
- `byte[] getBytes(String charsetName)`: Returns a new byte array containing the characters of this string encoded using the named charset.

Note that `String(byte[] data, String charsetName)` and `byte[] getBytes(String charsetName)` throw `java.io.UnsupportedEncodingException` when the charset isn't supported.

I've created a small application that demonstrates `String` and charsets. Listing 13-21 presents the source code.

*Listing 13-21. Using Charsets with String*

```
import java.io.UnsupportedEncodingException;

public class CharsetDemo
{
    public static void main(String[] args) throws UnsupportedEncodingException
    {
        byte[] encodedMsg =
        {
            0x66, 0x61, (byte) 0xc3, (byte) 0xa7, 0x61, 0x64, 0x65, 0x20, 0x74,
            0x6f, 0x75, 0x63, 0x68, (byte) 0xc3, (byte) 0xa9
        };
        String s = new String(encodedMsg, "UTF-8");
        System.out.println(s);
        System.out.println();
        byte[] bytes = s.getBytes();
        for (byte _byte: bytes)
            System.out.print(Integer.toHexString(_byte & 255) + " ");
        System.out.println();
    }
}
```

Listing 13-21's `main()` method first creates a byte array containing a UTF-8 encoded message. It then converts this array to a `String` object via the UTF-8 charset. After outputting the resulting `String` object, it extracts this object's bytes into a new byte array and proceeds to output these bytes in hexadecimal format. As demonstrated earlier in this chapter, I bitwise AND each byte value with 255 to remove the `0xFF` sign extension bytes for negative integers when the 8-bit byte integer value is converted to a 32-bit integer value. These sign extension bytes would otherwise be output.

Compile Listing 13-21 (`javac CharsetDemo.java`), and run this application (`java CharsetDemo`). You should observe the following output:

---

```
 façade touché
```

```
66 61 e7 61 64 65 20 74 6f 75 63 68 e9
```

---

You might be wondering why you observe `e7` instead of `c3 a7` (Latin small letter *c* with a *cedilla* [hook or tail]) and `e9` instead of `c3 a9` (Latin small letter *e* with an acute accent). The answer is that I invoked the noargument `getBytes()` method to encode the string. This method uses the default charset, which is `windows-1252` on my platform. According to this charset, `e7` is equivalent to `c3 a7` and `e9` is equivalent to `c3 a9`. The result is a shorter encoded sequence.

## Working with Formatter and Scanner

The description for JSR 51 (<http://jcp.org/en/jsr/detail?id=51>) indicates that a simple `printf`-style formatting facility was proposed for inclusion in NIO. If you're familiar with the C language, you've probably worked with the `printf()` family of functions that support formatted output. You've also probably worked with the complementary `scanf()` family that support formatted input.

One feature that makes the `printf()` and `scanf()` functions useful is `varargs`, which lets you pass a variable number of arguments to these functions. Because support for `varargs` wasn't added to Java until JDK 1.5, and because this support is very useful for achieving formatted output (Java doesn't need it for formatted input), the formatted `printf`-style formatting facility was deferred to JDK 1.5.

## Working with Formatter

Java 5 introduced the `java.util.Formatter` class as an interpreter for `printf()`-style format strings. This class provides support for layout justification and alignment; common formats for numeric, string, and date/time data; and more. Commonly used Java types (such as `byte` and `BigDecimal`) are supported. Also, limited formatting customization for arbitrary user-defined types is provided through the associated `java.util.Formattable` interface and `java.util.FormattableFlags` class.

`Formatter` declares several constructors for creating `Formatter` objects. These constructors let you specify where you want formatted output to be sent. For example, `Formatter()` writes formatted output to an internal `StringBuilder` instance and `Formatter(OutputStream os)` writes formatted output to the specified output stream. You can access the destination by calling `Formatter`'s `Appendable out()` method.

**Note** The `java.lang.Appendable` interface describes an object to which `char` values and character sequences can be appended. Classes (such as `StringBuilder`) whose instances are to receive formatted output (via the `Formatter` class) implement `Appendable`. This interface declares methods such as `Appendable append(char c)`—append `c`'s character to this appendable. When an I/O error occurs, this method throws `IOException`.

After creating a `Formatter` object, you would call a `format()` method to format a varying number of values. For example, `Formatter format(String format, Object... args)` formats the `args` array according to the string of format specifiers passed to the `format` parameter, and it returns a reference to the invoking `Formatter` so that you can chain `format()` calls together (for convenience).

Each format specifier has one of the following syntaxes:

- `%[argument_index$][flags][width][.precision]conversion`
- `%[argument_index$][flags][width]conversion`
- `%[flags][width]conversion`

The first syntax describes a format specifier for general, character, and numeric types. The second syntax describes a format specifier for types that are used to represent dates and times. The third syntax describes a format specifier that doesn't correspond to arguments.

The optional *argument\_index* is a decimal integer indicating the position of the argument in the argument list. The first argument is referenced by `1$`, the second argument is referenced by `2$`, and so on.

The optional *flags* are a set of characters that modify the output format. The set of valid flags depends on the conversion.

The optional *width* is a positive decimal integer indicating the minimum number of characters to be written to the output.

The optional *precision* is a nonnegative decimal integer usually used to restrict the number of characters. The specific behavior depends on the conversion.

The required conversion depends on the syntax. For the first syntax, it's a character indicating how the argument should be formatted. The set of valid conversions for a given argument depends on the argument's data type. For the second syntax, it's a two-character sequence. The first character is `t` or `T`. The second character indicates the format to be used. For the third syntax, it's a character indicating content to be inserted in the output.

Conversions are divided into six categories: general, character, numeric (integer or floating-point), date/time, percent, and line separator. The following list identifies a few example format specifiers and their conversions:

- `%d`: Formats argument as a decimal integer.
- `%x`: Formats argument as a hexadecimal integer.
- `%c`: Formats argument as a character.
- `%f`: Formats argument as a decimal number.
- `%s`: Formats argument as a string.
- `%n`: Outputs a platform-specific line separator.
- `%10.2f`: Formats argument as a decimal number with 10 as the minimum number of characters to be written (leading spaces are written when the number is smaller than the width) and 2 as the number of characters to be written after the decimal point.
- `%05d`: Formats argument as a decimal integer with 5 as the minimum number of characters to be written (leading 0s are written when the number is smaller than the width).

When you're finished with the formatter, you might want to invoke the `void flush()` method to ensure that any buffered output in the destination is written to the underlying stream. You would typically invoke `flush()` when the destination is a file.

Continuing, invoke the formatter's `void close()` method. In addition to closing the formatter, this method also closes the underlying output destination when this destination's class implements the `java.io.Closeable` interface. If the formatter has been closed, this method has no effect. Attempting to format after calling `close()` results in `java.util.FormatterClosedException`.

Listing 13-22 provides a simple demonstration of `Formatter` using the aforementioned format specifiers.

*Listing 13-22. Demonstrating the Formatter Class*

```
import java.util.Formatter;

public class FormatterDemo
{
    public static void main(String[] args)
    {
        Formatter formatter = new Formatter();
        formatter.format("%d", 123);
        System.out.println(formatter.toString());
        formatter.format("%x", 123);
        System.out.println(formatter.toString());
        formatter.format("%c", 'X');
        System.out.println(formatter.toString());
        formatter.format("%f", 0.1);
        System.out.println(formatter.toString());
        formatter.format("%s%n", "Hello, World");
        System.out.println(formatter.toString());
        formatter.format("%10.2f", 98.375);
        System.out.println(formatter.toString());
        formatter.format("%05d", 123);
        System.out.println(formatter.toString());
        formatter.format("%1$d %1$d", 123);
        System.out.println(formatter.toString());
        formatter.format("%d %d", 123);
        System.out.println(formatter.toString());
        formatter.close();
    }
}
```

Listing 13-22's `main()` method first creates a `Formatter` object via the `Formatter()` constructor, which sends formatted output to a `StringBuilder` instance. It then demonstrates the aforementioned format specifiers by invoking a `format()` method, followed by the `toString()` method to obtain the formatted content, which is subsequently output.

The `formatter.format("%1$d %1$d", 123);` method call accesses the single data item argument to be formatted (123) twice by referencing this argument via `1$`. Without this reference, which is demonstrated via `formatter.format("%d %d", 123);`, an exception would be thrown because there must be a separate argument for each format specifier unless you use an argument index.

Lastly, the formatter is closed.

Compile Listing 13-22 as follows:

```
javac FormatterDemo.java
```

Run this application as follows:

```
java FormatterDemo
```

You should observe the following output:

```
123
1237b
1237bX
1237bX0.100000
1237bX0.100000Hello, World

1237bX0.100000Hello, World
 98.38
1237bX0.100000Hello, World
 98.3800123
1237bX0.100000Hello, World
 98.3800123123 123
Exception in thread "main" java.util.MissingFormatArgumentException: Format specifier 'd'
    at java.util.Formatter.format(Formatter.java:2487)
    at java.util.Formatter.format(Formatter.java:2423)
    at FormatterDemo.main(FormatterDemo.java:24)
```

The first thing to notice about the output is that each `format()` call appends formatted output to the previously formatted output. The second thing to notice is that `java.util.MissingFormatArgumentException` is thrown when you don't specify a needed argument.

**Note** `MissingFormatArgumentException` is one of several formatter exception types. These exception types subtype the `java.util.IllegalFormatException` type.

If you aren't happy with this concatenated output, there are two ways to solve the problem:

- Instantiate a new `Formatter` instance, as in `formatter = new Formatter();`, before calling `format()`. This ensures that a new default and empty string builder is created.
- Create your own `StringBuilder` instance and pass it to a constructor such as `Formatter(Appendable a)`. After outputting the formatted content, invoke `StringBuilder`'s void `setLength(int newLength)` method with 0 as the argument to erase previous content.

It's cumbersome to have to create and manage a `Formatter` object when all you want to do is to achieve something equivalent to the C language's `printf()` function. Java addresses this situation by adding formatter support to the `java.io.PrintStream` class.

Of the various formatter-oriented methods added to `PrintStream`, you'll often invoke `PrintStream printf(String format, Object... args)`. After sending its formatted content to the print stream, this method returns a reference to this stream so that you can chain method calls together.

Listing 13-23 provides a small `printf()` demonstration.



*Listing 13-23. Formatting via printf()*

```
public class FormatterDemo
{
    public static void main(String[] args)
    {
        System.out.printf("%04X%n", 478);
        System.out.printf("Current date: %1$tb %1$te, %1$tY%n",
            System.currentTimeMillis());
    }
}
```

Listing 13-23's `main()` method invokes `System.out.printf()` twice. The first invocation formats 32-bit integer 478 into a four-digit hexadecimal string with a leading zero and uppercase hexadecimal digits. The second invocation formats the current millisecond value returned from `System.currentTimeMillis()` into a date. The `tb` conversion specifies an abbreviated month name (such as Jan), the `te` conversion specifies the day of the month (such as 1 through 31), and the `tY` conversion specifies the year (formatted with at least four digits, with leading 0s as necessary).

Compile Listing 13-23 (`javac FormatterDemo.java`), and run the application (`java FormatterDemo`). You should observe output similar to the output shown below:

---

```
01DE
Current date: Jan 14, 2014
```

---

**Note** For more information on `Formatter` and its supported format specifiers, I refer you to `Formatter`'s Java documentation. You might also want to check out the documentation on the `Formattable` interface and `FormattableFlags` class to learn about customizing `Formatter`.

## Working with Scanner

Java 5 introduced the `java.util.Scanner` class to parse input characters into primitive types, strings, and big integers/big decimals with the help of regular expressions. `Scanner` declares several constructors for scanning content originating from diverse sources. For example, `Scanner(InputStream source)` creates a scanner for scanning the specified input stream, whereas `Scanner(String source)` creates a scanner for scanning the specified string.

A `Scanner` instance uses a *delimiter pattern*, which matches whitespace by default, to break its input into discrete values. After creating this instance, you can call one of the “hasNext” methods to verify that an anticipated character sequence is present for scanning. For example, you could call `boolean hasNextDouble()` to determine whether or not the next sequence of characters can be scanned into a double precision floating-point value.

When the value is present, you would call the appropriate “next” method to scan the value. For example, you would call `double nextDouble()` to scan this sequence and return a `double` containing its value.

When you're finished with the scanner, invoke its void `close()` method. Beyond closing the scanner, this method also closes the underlying input source when this source's class implements the `Closeable` interface. If the scanner has been closed, this method has no effect. Any attempt to scan after calling this method will result in `IllegalStateException`.

The following example shows you how to create a scanner for scanning values from standard input and then scanning an integer followed by a double precision floating-point value:

```
Scanner sc = new Scanner(System.in);
if (sc.hasNextInt())
    i = sc.nextInt();
if (sc.hasNextDouble())
    d = sc.nextDouble();
```

Listing 13-24 presents a more realistic (menu-oriented) example.

*Listing 13-24. Scanning Input in a Menu Context*

```
import java.util.Scanner;

public class ScannerDemo
{
    public static void main(String[] args)
    {
        Scanner scanner = new Scanner(System.in);
        while (true)
        {
            System.out.printf("%nMenu Options%n%n");
            System.out.println("1: Frequency Count");
            System.out.printf("2: Quit%n%n");
            System.out.print("Enter your selection (1 or 2): ");
            int selection = scanner.nextInt();
            scanner.nextLine();
            if (selection == 1)
            {
                System.out.printf("%nEnter sentence: ");
                String sentence = scanner.nextLine();
                System.out.print("Enter index: ");
                int index = scanner.nextInt();
                int count = 0;
                for (int i = 0; i < sentence.length(); i++)
                    if (sentence.charAt(i) == sentence.charAt(index))
                        count++;
                System.out.printf("Count of [%c] in [%s]: %d%n",
                                sentence.charAt(index), sentence, count);
            }
            else
                if (selection == 2)
                    break;
        }
        scanner.close();
    }
}
```

Listing 13-24's `main()` method creates a scanner that scans input from the standard input stream and then enters a while loop. Each of the loop iterations presents a two-option menu and prompts the user to select one of these options.

Option selection is made via a `scanner.nextInt()` method call. Because `nextInt()` doesn't consume the line terminator following the selection number, a call to Scanner's void `nextLine()` method is made to skip over the line terminator so as not to affect sentence entry (when option 1 is chosen).

If the user selected option 1, the user is prompted to enter a sentence along with the zero-based index of one of the sentence characters. The sentence is then iterated over, and all occurrences of the indexed character are tallied. This count is subsequently output.

If the user selected option 2, the loop is broken and the application ends.

Compile Listing 13-24 as follows:

```
javac ScannerDemo.java
```

Run this application as follows:

```
javac ScannerDemo
```

The following output reveals one run of this application:

---

Menu Options

```
1: Frequency Count
2: Quit
```

```
Enter your selection (1 or 2): 1
```

```
Enter sentence: This is a test.
Enter index: 2
Count of [i] in [This is a test.]: 2
```

Menu Options

```
1: Frequency Count
2: Quit
```

```
Enter your selection (1 or 2): 2
```

---

**Note** To learn more about Scanner, check out this class's Java documentation.

## EXERCISES

The following exercises are designed to test your understanding of Chapter 13's content.

1. Define New I/O.
2. What is a buffer?
3. Identify a buffer's four properties.
4. What happens when you invoke Buffer's `array()` method on a buffer backed by a read-only array?
5. What happens when you invoke Buffer's `flip()` method on a buffer?
6. What happens when you invoke Buffer's `reset()` method on a buffer where a mark has not been set?
7. True or False: Buffers are thread-safe.
8. Identify the classes that extend the abstract Buffer class.
9. How do you create a byte buffer?
10. Define view buffer.
11. How is a view buffer created?
12. How do you create a read-only view buffer?
13. Identify ByteBuffer's methods for storing a single byte in a byte buffer and fetching a single byte from a byte buffer.
14. What causes `BufferOverflowException` or `BufferUnderflowException` to occur?
15. What is the equivalent of executing `buffer.flip();`?
16. True or false: Calling `flip()` twice returns you to the original state.
17. What is the difference between Buffer's `clear()` and `reset()` methods?
18. What does ByteBuffer's `compact()` method accomplish?
19. What is the purpose of the `ByteOrder` class?
20. Define direct byte buffer.
21. How do you obtain a direct byte buffer?
22. What is a channel?
23. What capabilities does the `Channel` interface provide?
24. Identify the three interfaces that directly extend `Channel`.
25. True or false: A channel that implements `InterruptibleChannel` is asynchronously closeable.
26. Identify the two ways to obtain a channel.
27. Define scatter/gather I/O.
28. What interfaces are provided for achieving scatter/gather I/O?

29. Define file channel.
30. True or false: File channels don't support scatter/gather I/O.
31. Define exclusive lock and shared lock.
32. What is the fundamental difference between `FileChannel`'s `lock()` and `tryLock()` methods?
33. What does the `FileLock lock()` method do when either a lock is already held that overlaps this lock request or another thread is waiting to acquire a lock that will overlap with this request?
34. Specify the pattern that you should adopt to ensure that an acquired file lock is always released.
35. What method does `FileChannel` provide for mapping a region of a file into memory?
36. Identify the three file-mapping modes.
37. Which file-mapping mode corresponds to copy-on-write?
38. Identify the `FileChannel` methods that optimize the common practice of performing bulk transfers.
39. True or false: Socket channels are selectable and can function in nonblocking mode.
40. Identify the three classes that describe socket channels.
41. True or false: Datagram channels are not thread-safe.
42. Why do socket channels support nonblocking mode?
43. How would you obtain a socket channel's associated socket?
44. How do you obtain a server socket channel?
45. Define selector.
46. Identify the three main types that support selectors.
47. True or false: File channels can be used with selectors.
48. Define regular expression.
49. What does the `Pattern` class accomplish?
50. What do `Pattern`'s `compile()` methods do when they discover illegal syntax in their regular expression arguments?
51. What does the `Matcher` class accomplish?
52. What is the difference between `Matcher`'s `matches()` and `lookingAt()` methods?
53. Define character class.
54. Identify the various kinds of character classes.
55. Define capturing group.
56. What is a zero-length match?
57. Define quantifier.
58. What is the difference between a greedy quantifier and a reluctant quantifier?
59. How do possessive and greedy quantifiers differ?

60. Identify the two main classes that contribute to the NIO printf-style formatting facility.
61. What does the %n format specifier accomplish?
62. Refactor Listing 11–11 (Chapter 11's Copy application) to use the `ByteBuffer` and `FileChannel` classes in partnership with `FileInputStream` and `FileOutputStream`.
63. Create a `ReplaceText` application that takes input text, a pattern that specifies text to replace, and replacement text command-line arguments, and uses `Matcher`'s `String replaceAll(String replacement)` method to replace all matches of the pattern with the replacement text (passed to `replaceAll()`). For example, `java ReplaceText "too many embedded spaces" "\s+" " "` should output `too many embedded spaces` with only a single space character between successive words.
64. Create a `ValidateInput` application that reads the contents of standard input (via the `Scanner` class) and views this content as a sequence of lines with each line containing a string-based name followed by an integer-based age. For example, one line might contain `Jack 40` and another line might contain `Jill 32`. If the current line is empty, the application should output `name field missing`. If the current line contains a name field only, the application should output `age field missing`. After reading a line, the application should output the line followed by a 1-based line number. It should extract the individual name and age and output, for example, `Name: Jack` and `Age: 40`. Include the current line number when outputting the line and individual messages. In addition to the previous lines, test this application with a line containing `George` only, a line containing `42` only, and an empty line.

---

## Summary

Java 1.4 introduced a more powerful I/O architecture that supports memory-mapped file I/O, readiness selection, file locking, and more. This architecture largely consists of buffers, channels, selectors, regular expressions, and charsets, and it is commonly known as New I/O (NIO).

NIO is based on buffers. A buffer is an object that stores a fixed amount of data to be sent to or received from an I/O service (a means for performing input/output). It sits between an application and a channel that writes the buffered data to the service or reads the data from the service and deposits it into the buffer. Java supports buffers by providing the `Buffer` class, assorted subclasses, and the `ByteOrder` typesafe enumeration.

Channels partner with buffers to achieve high-performance I/O. A channel is an object that represents an open connection to a hardware device, a file, a network socket, an application component, or another entity that's capable of performing write, read, and other I/O operations. Channels efficiently transfer data between byte buffers and I/O service sources or destinations. Java supports channels by providing the `Channel` interface and related types.

Selectors let you achieve readiness selection in a Java context. Readiness selection offloads to the operating system the work involved in checking for I/O stream readiness to perform write, read, and other operations. The operating system is instructed to observe a group of channels and return some indication of which channels are ready to perform a specific operation (such as read) or operations (such as accept and read). This capability lets a thread multiplex a potentially huge number of active channels by using the readiness information provided by the operating system. In this way, network

servers can handle large numbers of network connections; they are vastly scalable. Java supports selectors by offering the `SelectableChannel`, `SelectionKey`, and `Selector` classes.

Text-processing applications often need to match text against patterns (character strings that concisely describe sets of strings that are considered to be matches). For example, an application might need to locate all occurrences of a specific word pattern in a text file so that it can replace those occurrences with another word. NIO includes regular expressions to help text-processing applications perform pattern matching with high performance. Java supports regular expressions by providing the `Pattern` and `Matcher` classes.

Charsets combine coded character sets with character-encoding schemes. They're used to translate between byte sequences and the characters that are encoded into these sequences. Java supports charsets by providing `Charset` and related classes.

The description for JSR 51 (the NIO JSR) indicates that a simple `printf`-style formatting facility was proposed for inclusion in NIO. This facility consists of formatted output and formatted input. Because the C language versions of these features depend on `varargs`, and because support for `varargs` wasn't added to Java until Java 5, this facility didn't debut in Java 1.4. Instead, the `printf` facility was deferred to Java 5, which added `Formatter` and related types to perform formatted output and `Scanner`, which doesn't depend on `varargs`, to perform formatted input.

Chapter 14 focuses on database access. You first encounter the Java DB and SQLite database products and then learn how to use the JDBC API to create/access their databases.

# Accessing Databases

Applications often need to access databases to store and retrieve various kinds of data. A *database* (<http://en.wikipedia.org/wiki/Database>) is an organized collection of data. Although there are many kinds of databases (such as hierarchical, object-oriented, and relational), *relational databases*, which organize data into tables that can be related to each other, are common.

**Note** In a relational database, each row stores a single item (such as an employee) and each column stores a single item attribute (such as an employee's name).

Except for the most trivial of databases (such as Chapter 11's flat file database based on a single data file), databases are created and managed through a *database management system (DBMS)*—see [http://en.wikipedia.org/wiki/Database\\_management\\_system](http://en.wikipedia.org/wiki/Database_management_system). Relational DBMSs (RDBMSs) support *Structured Query Language (SQL)* for working with tables and more.

**Note** For brevity, I assume that you're familiar with SQL. If not, you might want to check out Wikipedia's "SQL" entry (<http://en.wikipedia.org/wiki/SQL>) for an introduction.

Java supports database access and creation (and more) via its relational database-oriented JDBC (Java Database Connectivity) API. Because you need an RDBMS before you can explore JDBC, this chapter first introduces you to Java DB, which is included with the JDK, followed by the popular SQLite (<http://en.wikipedia.org/wiki/Sqlite>). This chapter then focuses on JDBC.



**Note** Android offers an alternative to JDBC via its `android.database` and `android.database.sqlite` packages, which are the preferred means for accessing databases from an Android application. Although Android supports JDBC by including this API and an undocumented JDBC driver (I discuss JDBC drivers later in this chapter), you should focus on using Android’s database access alternative when developing an Android application that requires database access. Because you still might find JDBC useful, especially when creating a non-Android application, I present JDBC in this chapter.

## Introducing Java DB

First introduced by Sun Microsystems as part of JDK 6 (and not included in the JRE) to give developers an RDBMS to test their JDBC code, *Java DB* is a distribution of Apache’s open-source Derby product, which is based on IBM’s Cloudscape RDBMS code base. This pure-Java RDBMS is also bundled with JDK 7 (but not in the JRE). It’s secure, supports JDBC and SQL (including transactions, stored procedures, and concurrency), and has a small footprint—its core engine and JDBC driver occupy approximately 2MB.

**Note** A *JDBC driver* is a classfile plug-in for communicating with a database. I’ll have more to say about JDBC drivers when I introduce JDBC later in this chapter.

Java DB is capable of running in an embedded environment or in a client/server environment. In an embedded environment, where an application accesses the database engine via Java DB’s *embedded driver*, the database engine runs in the same virtual machine as the application. Figure 14-1 illustrates the embedded environment architecture, where the database engine is embedded in the application.

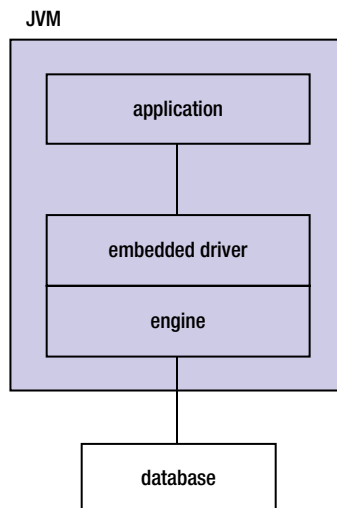

**Figure 14-1.** No separate processes are required to start up or shut down an embedded database engine

In a client/server environment, client applications and the database engine run in separate virtual machines. A client application accesses the network server through Java DB's *client driver*. The network server, which runs in the same virtual machine as the database engine, accesses the database engine through the embedded driver. Figure 14-2 illustrates this architecture.

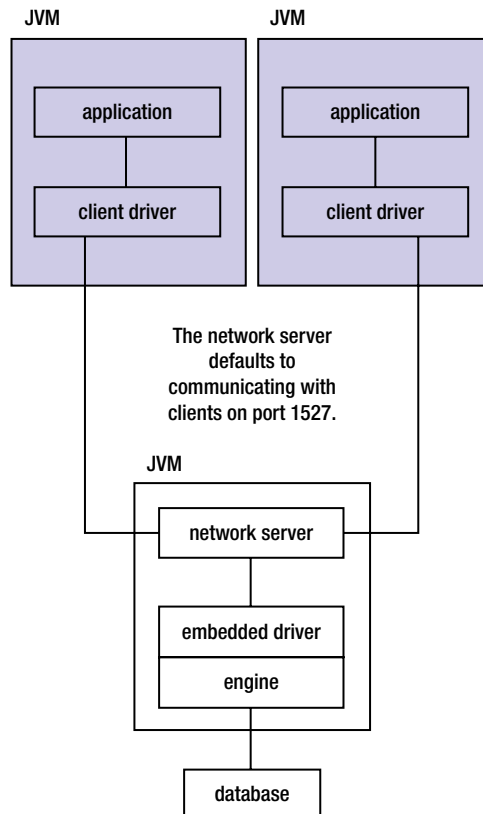

**Figure 14-2.** Multiple clients communicate with the same database engine through the network server

Java DB implements the database portion of the architectures shown in Figures 14-1 and 14-2 as a directory with the same name as the database. Within this directory, Java DB creates a log directory to store transaction logs, a `seg0` directory to store the data files, and a `service.properties` file to store configuration parameters.

**Note** Java DB doesn't provide an SQL command to *drop* (destroy) a database. Destroying a database requires that you manually delete its directory structure.

## Java DB Installation and Configuration

When you install JDK 7 with the default settings, the bundled Java DB is installed into %JAVA\_HOME%\db on Windows platforms, or into the db subdirectory in the equivalent location on Unix/Linux platforms. (For convenience, I adopt the Windows convention when presenting environment variable paths.)

**Note** I focus on Java DB 10.8.2.2 in this chapter because it's included with JDK 7 build 1.7.0\_06-b24, which is the Java build on which this book is based.

The db directory contains five files and the following pair of subdirectories:

- The bin directory contains scripts for setting up embedded and client/server environments, running command-line tools, and starting/stopping the network server. You should add this directory to your PATH environment variable so that you can conveniently execute its scripts from anywhere in the filesystem.
- The lib directory contains various JAR files that house the engine library (derby.jar), the command-line tools libraries (derbytools.jar and derbyrun.jar), the network server library (derbynet.jar), the network client library (derbyclient.jar), and various locale-specific libraries. This directory also contains derby.war, which is used to register the network *servlet* (see [http://en.wikipedia.org/wiki/Java\\_Servlet](http://en.wikipedia.org/wiki/Java_Servlet)) at the /derbynet relative path—it's also possible to manage the Java DB network server remotely via the servlet interface (see <http://db.apache.org/derby/docs/10.8/adminguide/cadminervlet98430.html>).

Before you can run the tools and start/stop the network server, you must set the DERBY\_HOME environment variable. Set this variable for Windows via set DERBY\_HOME=%JAVA\_HOME%\db, and for Unix (Korn shell) via export DERBY\_HOME=\$JAVA\_HOME/db. (This setting will not persist past the current command shell session unless you make it permanent.)

**Note** The embedded and client/server environment setup scripts refer to a DERBY\_INSTALL environment variable. According to the “Re: DERBY\_INSTALL and DERBY\_HOME” mail item ([www.mail-archive.com/derby-dev@db.apache.org/msg22098.html](http://www.mail-archive.com/derby-dev@db.apache.org/msg22098.html)), DERBY\_HOME is equivalent to and replaces DERBY\_INSTALL for consistency with other Apache projects.

You must also set the CLASSPATH environment variable. The easiest way to set this environment variable is to run a script file included with Java DB. Windows and Unix/Linux versions of various “setxxxCP” script files (which extend the current classpath) are located in the %JAVA\_HOME%\db\bin directory. The script file(s) to run will depend on whether you work with the embedded or client/server environment:

- For the embedded environment, invoke `setEmbeddedCP` to add `derby.jar` and `derbytools.jar` to the classpath.
- For the client/server environment, invoke `setNetworkServerCP` to add `derbynet.jar` and `derbytools.jar` to the classpath. In a separate command window, invoke `setNetworkClientCP` to add `derbyclient.jar` and `derbytools.jar` to the classpath.

## Java DB Demos

For JDK 7, the Java DB demos are included with other Java demos in a separate distribution file—see [www.oracle.com/technetwork/java/javase/downloads/index-jsp-138363.html](http://www.oracle.com/technetwork/java/javase/downloads/index-jsp-138363.html). After downloading and unarchiving the distribution file, you can move it to %JAVA\_HOME%. If you’re running Windows 7, you’ll also need to ensure that Java DB can write files to subdirectories of C:\Program Files (64-bit JDK) or C:\Program Files (x86) (32-bit JDK). Otherwise, you’ll encounter “access denied” errors.

The %JAVA\_HOME%\demo\db\programs directory contains HTML documentation that describes the demos included with Java DB; the `demo.html` file is the entry point into this documentation. These demos include a simple JDBC application for working with Java DB, a network server sample program, and sample programs that are introduced in the *Working with Derby* manual.

**Note** The *Working with Derby* manual underscores Java DB’s Derby heritage. You can download this manual and other Derby manuals from the documentation section (<http://db.apache.org/derby/manuals/index.html>) of Apache’s Derby project site (<http://db.apache.org/derby/index.html>).

For brevity, I’ll focus only on the simple JDBC application that’s located in the `programs` directory’s `simple` subdirectory. This application runs in either the default embedded environment or the client/server environment. It creates and connects to a `derbyDB` database, introduces a table into this database, performs SQL insert/update/select operations on this table, *drops* (removes) the table, and disconnects from the database.

To run this application in the embedded environment, open a command window and make sure that the `DERBY_HOME` and `CLASSPATH` environment variables have been set properly; then invoke `setEmbeddedCP` to set the classpath. Assuming that `simple` is the current directory, invoke `java SimpleApp` or `java SimpleApp embedded` to run this application. You should observe the following output:

```
SimpleApp starting in embedded mode
Loaded the appropriate driver
Connected to and created database derbyDB
```

```

Created table location
Inserted 1956 Webster
Inserted 1910 Union
Updated 1956 Webster to 180 Grand
Updated 180 Grand to 300 Lakeshore
Verified the rows
Dropped table location
Committed the transaction
Derby shut down normally
SimpleApp finished

```

This output reveals that an application running in the embedded environment shuts down the database engine before exiting. This is done to perform a checkpoint and release resources. When this shutdown doesn't occur, Java DB notes the absence of the checkpoint, assumes a crash, and causes recovery code to run before the next database connection (which takes longer to complete).

**Tip** When running SimpleApp (or any other Java DB application) in the embedded environment, you can determine where the database directory will be created by setting the `derby.system.home` property. For example, `java -Dderby.system.home=c:\temp SimpleApp` causes derbyDB to be created in the `temp` subdirectory of the root directory of the C: drive on the Windows 7 platform.

To run this application in the client/server environment, you need to start the network server and run the application in separate command windows.

In one command window, set `DERBY_HOME`. Start the network server via the `startNetworkServer` script (located in `%JAVA_HOME%\db\bin`), which takes care of setting the classpath. You should see output similar to this:

```

Fri Oct 18 13:21:35 CST 2013 : Security manager installed using the Basic server security policy.
Fri Oct 18 13:21:36 CST 2013 : Apache Derby Network Server - 10.8.2.2 - (1181258) started and ready
to accept connections on port 1527

```

In the other command window, set `DERBY_HOME` followed by `CLASSPATH` (via `setNetworkClientCP`). Assuming that the `simple` directory is current, execute the `java SimpleApp derbyClient` command line to run this application. This time, you should observe the following output:

```

SimpleApp starting in derbyclient mode
Loaded the appropriate driver
Connected to and created database derbyDB
Created table location
Inserted 1956 Webster
Inserted 1910 Union
Updated 1956 Webster to 180 Grand
Updated 180 Grand to 300 Lakeshore
Verified the rows

```

```
Dropped table location
Committed the transaction
SimpleApp finished
```

Notice that the database engine is not shut down in the client/server environment. Although not indicated in the output, there's a second difference between running SimpleApp in the embedded and client/server environments. In the embedded environment, the derbyDB database directory is created in the simple directory. In the client/server environment, this database directory is created in the directory that was current when you executed startNetworkServer.

When you're finished playing with SimpleApp in the client/server environment, you should shut down the network server and database engine. Accomplish this task by invoking the stopNetworkServer script (located in %JAVA\_HOME%\db\bin). You can also shut down (or start and otherwise control) the network server by running the NetworkServerControl script (also located in %JAVA\_HOME%\db\bin). For example, NetworkServerControl shutdown shuts down the network server and database engine.

## Java DB Command-Line Tools

The %JAVA\_HOME%\db\bin directory contains sysinfo, ij, and dblook Windows and Unix/Linux script files for launching command-line tools:

- Run sysinfo to view the Java environment/Java DB configuration.
- Run ij to run scripts that execute ad hoc SQL commands and perform repetitive tasks.
- Run dblook to view all or part of a database's Data Definition Language (DDL).

If you experience trouble with Java DB (such as not being able to connect to a database), you can run sysinfo to find out if the problem is configuration-related. This tool reports various settings under the Java Information, Derby Information, and Locale Information headings. It outputs the following information on my platform:

```
----- Java Information -----
Java Version:    1.7.0_06
Java Vendor:    Oracle Corporation
Java home:      C:\Program Files\Java\jdk1.7.0_06\jre
Java classpath: C:\PROGRA~1\Java\JDK17~2.0_0\db\lib\derbyclient.jar;C:\PROGRA~1\Java\JDK17~2.0_0\
db\lib\derbytools.jar;.;C:\Program Files (x86)\QuickTime\QTSystem\QTJava.zip;C:\PROGRA~1\Java\
JDK17~2.0_0\db\lib\derby.jar;C:\PROGRA~1\Java\JDK17~2.0_0\db\lib\derbynet.jar;C:\PROGRA~1\Java\
JDK17~2.0_0\db\lib\derbyclient.jar;C:\PROGRA~1\Java\JDK17~2.0_0\db\lib\derbytools.jar
OS name:        Windows 7
OS architecture: amd64
OS version:     6.1
Java user name: Owner
Java user home: C:\Users\Owner
Java user dir:  C:\PROGRA~1\Java\jdk1.7.0_06\db\bin
java.specification.name: Java Platform API Specification
java.specification.version: 1.7
java.runtime.version: 1.7.0_06-b24
```

```

----- Derby Information -----
JRE - JDBC: Java SE 7 - JDBC 4.0
[C:\Program Files\Java\jdk1.7.0_06\db\lib\derby.jar] 10.8.2.2 - (1181258)
[C:\Program Files\Java\jdk1.7.0_06\db\lib\derbytools.jar] 10.8.2.2 - (1181258)
[C:\Program Files\Java\jdk1.7.0_06\db\lib\derbynet.jar] 10.8.2.2 - (1181258)
[C:\Program Files\Java\jdk1.7.0_06\db\lib\derbyclient.jar] 10.8.2.2 - (1181258)
-----
----- Locale Information -----
Current Locale : [English/Canada [en_CA]]
Found support for locale: [cs]
    version: 10.8.2.2 - (1181258)
Found support for locale: [de_DE]
    version: 10.8.2.2 - (1181258)
Found support for locale: [es]
    version: 10.8.2.2 - (1181258)
Found support for locale: [fr]
    version: 10.8.2.2 - (1181258)
Found support for locale: [hu]
    version: 10.8.2.2 - (1181258)
Found support for locale: [it]
    version: 10.8.2.2 - (1181258)
Found support for locale: [ja_JP]
    version: 10.8.2.2 - (1181258)
Found support for locale: [ko_KR]
    version: 10.8.2.2 - (1181258)
Found support for locale: [pl]
    version: 10.8.2.2 - (1181258)
Found support for locale: [pt_BR]
    version: 10.8.2.2 - (1181258)
Found support for locale: [ru]
    version: 10.8.2.2 - (1181258)
Found support for locale: [zh_CN]
    version: 10.8.2.2 - (1181258)
Found support for locale: [zh_TW]
    version: 10.8.2.2 - (1181258)
-----

```

The `ij` script is useful for creating a database and initializing a user's *schema* (a namespace that logically organizes tables and other database objects) by running a script file that specifies the appropriate DDL statements. For example, you've created an `EMPLOYEES` table with its `NAME` and `PHOTO` columns and you have created a `create_emp_schema.sql` script file in the current directory that contains the following line:

```
CREATE TABLE EMPLOYEES(NAME VARCHAR(30), PHOTO BLOB);
```

The following embedded `ij` script session creates the `employees` database and `EMPLOYEES` table:

```

C:\db>ij
ij version 10.8
ij> connect 'jdbc:derby:employees;create=true';
ij> run 'create_emp_schema.sql';

```

```

ij> CREATE TABLE EMPLOYEES(NAME VARCHAR(30), PHOTO BLOB);
0 rows inserted/updated/deleted
ij> disconnect;
ij> exit;
C:>\db>

```

The connect command causes the employees database to be created—I'll have more to say about this command's syntax when I introduce JDBC later in this chapter. The run command causes create\_emp\_schema.sql to execute, and the subsequent pair of lines is generated as a result.

The CREATE TABLE EMPLOYEES(NAME VARCHAR(30), PHOTO BLOB); line is an SQL statement for creating a table named EMPLOYEES with NAME and PHOTO columns. Data items entered into the NAME column are of SQL type VARCHAR (a varying number of characters—a string) with a maximum of 30 characters, and data items entered into the PHOTO column are of SQL type BLOB (a binary large object, such as an image).

**Note** I specify SQL statements in uppercase, but you can also specify them in lowercase or mixed case.

After run 'create\_emp\_schema.sql' finishes, the specified EMPLOYEES table is added to the newly created employees database. To verify the table's existence, run dblook against the employees directory, as the following session demonstrates:

```

C:\db>dblook -d jdbc:derby:employees
-- Timestamp: 2012-11-25 16:13:42.693
-- Source database is: employees
-- Connection URL is: jdbc:derby:employees
-- appendLogs: false

-- -----
-- DDL Statements for tables
-- -----

CREATE TABLE "APP"."EMPLOYEES" ("NAME" VARCHAR(30), "PHOTO" BLOB(2147483647));

C:\db>

```

All database objects (such as tables and indexes) are assigned to user and system schemas, which logically organize these objects in the same way that packages logically organize classes. When a user creates or accesses a database, Java DB uses the specified username as the namespace name for newly added database objects. In the absence of a username, Java DB chooses APP, as the preceding session output shows.



## Introducing SQLite

SQLite (<http://sqlite.org/>) is a very simple and popular RDBMS. Basically, it implements a self-contained, serverless, zero-configuration, transactional SQL database engine; and is considered to be the most widely deployed database engine in the world. For example, SQLite is found in Mozilla Firefox, Google Chrome, and other web browsers. It's also found in Google Android, Apple iOS, and other mobile operating systems.

**Note** To learn what sets SQLite apart from other RDBMs, visit the “Distinctive Features of SQLite” page at <http://sqlite.org/different.html>. As well as learning about features such as the aforementioned zero-configuration, you'll learn about features such as *manifest typing*, in which you can store any value of any data type in any column regardless of the declared type of that column.

To introduce yourself to SQLite, visit the SQLite home page at <http://sqlite.org/>. You can explore online documentation (<http://sqlite.org/docs.html>), download SQLite software (<http://sqlite.org/download.html>), and so on. Regarding downloads, you can download source code, documentation, and precompiled binaries for the Linux, Mac OS X (x86), and Windows platforms.

I downloaded the `sqlite-shell-win32-x86-3071401.zip` distribution file for my Windows 7 platform. This archive contains a single `sqlite3` executable, which offers a command-line shell for accessing and modifying SQLite databases. According to the SQLite downloads page, this program is compatible with all versions of SQLite through version 3.7.14.1 (and beyond). (The Android SDK for Windows also includes `sqlite3.exe` but not necessarily the same version.)

You can specify `sqlite3` with a database filename argument (such as `sqlite3 employees`) to create the database file (`employees`, for example) when it doesn't exist (you must create a table at least) or open the existing file and enter this tool's shell from where you can execute `sqlite3`-specific, dot-prefixed commands and SQL statements. As Figure 14-3 shows, you can also specify `sqlite3` without an argument and enter the shell.

```

C:\prj\dev\l1fad2\ch14\code>sqlite3
SQLite version 3.7.14.1 2012-10-04 19:37:12
Enter ".help" for instructions
Enter SQL statements terminated with a ";"
sqlite> .help
.backup ?DB? FILE      Backup DB (default "main") to FILE
.bail ON|OFF           Stop after hitting an error. Default OFF
.databases             List names and files of attached databases
.dump ?TABLE? ...     Dump the database in an SQL text format
                      If TABLE specified, only dump tables matching
                      LIKE pattern TABLE.
.echo ON|OFF          Turn command echo on or off
.exit                 Exit this program
.explain ?ON|OFF?     Turn output mode suitable for EXPLAIN on or off.
                      With no args, it turns EXPLAIN on.
.header(s) ON|OFF     Turn display of headers on or off
.help                Show this message
.import FILE TABLE   Import data from FILE into TABLE
.indices ?TABLE?     Show names of all indices
                      If TABLE specified, only show indices for tables
                      matching LIKE pattern TABLE.
.load FILE ?ENTRY?   Load an extension library
.log FILE!off        Turn logging on or off. FILE can be stderr/stdout
.mode MODE ?TABLE?   Set output mode where MODE is one of:
                      csv      Comma-separated values
                      column   Left-aligned columns. (See .width)
                      html     HTML <table> code
                      insert   SQL insert statements for TABLE
                      line     One value per line
                      list     Values delimited by .separator string
                      tabs     Tab-separated values
                      tcl      TCL list elements

```

Figure 14-3. *sqlite3* is invoked without a database filename argument

Figure 14-3 reveals the prologue that greets you after entering the *sqlite3* shell, which is indicated by the *sqlite>* prompt from where you enter commands. It also reveals part of the help text that's presented when you type the *sqlite3*-specific *.help* command.

**Tip** You can create a database after specifying *sqlite3* without an argument by entering the appropriate SQL statements to create and populate desired tables (and possibly create indexes) and then invoking *.backup filename* (where *filename* identifies the file that stores the database) before exiting *sqlite3*.

While discussing Java DB command-line tools, I presented a small employee-oriented database example consisting of an *employees* database and a *create\_emp\_schema.sql* script file that contains the following SQL statement for creating an *EMPLOYEES* table (consisting of names and photos).

```
CREATE TABLE EMPLOYEES(NAME VARCHAR(30), PHOTO BLOB);
```

Let's find out how to create this database and table with *sqlite3*.

At the command line, execute *sqlite3 employees*. At the resulting *sqlite>* command prompt, execute the aforementioned SQL statement, and then execute *.quit* to quit *sqlite3*. You should now observe an *employees* file in the same directory as *sqlite3*.

Re-execute `sqlite3 employees`. At the `sqlite>` command prompt, execute `.tables`. You should observe a single output line consisting of `EMPLOYEES`. Now execute `.schema employees` (case isn't significant) and you should see the aforementioned `CREATE TABLE` statement.

You can continue to play with `sqlite3` and the `employees` database/`EMPLOYEES` table. For example, you could insert a single row of data into the `EMPLOYEES` table via the following `INSERT` statement and then `select/output` this row via the following `SELECT` statement:

```
INSERT INTO EMPLOYEES VALUES('Duke', null);
SELECT * FROM EMPLOYEES;
```

You should observe the following line as the result—nothing appears for the photo because of its `null` value:

```
DUKE|
```

## Accessing Databases via JDBC

*JDBC* is an API (associated with the `java.sql` and `javax.sql` packages—I mainly focus on `java.sql` in this chapter) for communicating with RDBMSs in an RDBMS-independent manner. You can use JDBC to perform various database operations, such as submitting SQL statements that tell the RDBMS to create a table and to update or query tabular data.

## Data Sources, Drivers, and Connections

Although JDBC is typically used to communicate with RDBMSs, it also can be used to communicate with a flat file database. For this reason, JDBC uses the term *data source* (a data-storage facility ranging from a simple file to a complex relational database managed by an RDBMS) to abstract the source of data.

Because data sources are accessed in different ways (such as Chapter 11's flat file database is accessed via methods of the `java.io.RandomAccessFile` class, whereas Java DB and SQLite databases are accessed via SQL statements), JDBC uses *drivers* (classfile plug-ins) to abstract over their implementations. This abstraction lets you write an application that can be adapted to an arbitrary data source without having to change a single line of code (in most cases). Drivers are implementations of the `java.sql.Driver` interface.

JDBC recognizes four types of drivers.

- *Type 1 drivers* implement JDBC as a mapping to another data-access API (such as Open Database Connectivity, or ODBC—see <http://en.wikipedia.org/wiki/ODBC>). The driver converts JDBC method calls into function calls on the other library. The JDBC-ODBC Bridge Driver is an example and isn't supported by Oracle. It was commonly used in the early days of JDBC when other kinds of drivers were uncommon.
- *Type 2 drivers* are written partly in Java and partly in native code. They interact with a data source-specific native client library and are not portable for this reason. Oracle's OCI (Oracle Call Interface) client-side driver is an example.

- *Type 3 drivers* don't depend on native code and communicate with a *middleware server* (a server that sits between the application client and the data source) via an RDBMS-independent protocol. The middleware server then communicates the client's requests to the data source.
- *Type 4 drivers* don't depend on native code and implement the network protocol for a specific data source. The client connects directly to the data source instead of going through a middleware server.

Before you can communicate with a data source, you need to establish a connection. JDBC provides the `java.sql.DriverManager` class and the `javax.sql.DataSource` interface for this purpose.

- `DriverManager` lets an application connect to a data source by specifying a URL. When this class first attempts to establish a connection, it automatically loads any JDBC 4.x drivers located via the classpath. (Pre-JDBC 4.x drivers must be loaded manually.)
- `DataSource` hides connection details from the application to promote data source portability and is preferred over `DriverManager` for this reason. Because a discussion of `DataSource` is somewhat involved (and is typically used in a Java EE context), I focus on `DriverManager` in this chapter.

Before letting you obtain a data source connection, early JDBC versions required you to explicitly load a suitable driver by specifying `Class.forName()` with the name of the class that implements the `Driver` interface. For example, the JDBC-ODBC Bridge driver was loaded via `Class.forName("sun.jdbc.odbc.JdbcOdbcDriver");`. Later JDBC versions relaxed this requirement by letting you specify a list of drivers to load via the `jdbc.drivers` system property. `DriverManager` would attempt to load all of these drivers during its initialization.

Under Java 7, `DriverManager` first loads all drivers identified by the `jdbc.drivers` system property. It then uses the `java.util.ServiceLoader`-based service provider mechanism to load all drivers from accessible driver JAR files so that you don't have to explicitly load drivers. This mechanism requires a driver to be packaged into a JAR file that includes `META-INF/services/java.sql.Driver`. The `java.sql.Driver` text file must contain a single line that names the driver's implementation of the `Driver` interface.

Each loaded driver instantiates and registers itself with `DriverManager` via `DriverManager`'s `void registerDriver(Driver driver)` class method. When invoked, a `getConnection()` method walks through registered drivers, returning an implementation of the `java.sql.Connection` interface from the first driver that recognizes `getConnection()`'s JDBC URL. (You might want to check out `DriverManager`'s source code to see how this is done.)

**Note** To maintain data source-independence, much of JDBC consists of interfaces. Each driver provides implementations of the various interfaces.

To connect to a data source and obtain a `Connection` instance, call one of `DriverManager`'s `Connection getConnection(String url)`, `Connection getConnection(String url, Properties info)`, or `Connection getConnection(String url, String user, String password)` methods. With

either method, the `url` argument specifies a string-based URL that starts with the `jdbc:` prefix and continues with data source-specific syntax.

Consider Java DB. The URL syntax varies depending on the driver. For the embedded driver (when you want to access a local database), this syntax is as follows:

```
jdbc:derby:databaseName;URLAttributes
```

For the client driver (when you want to access a remote database, although you can also access a local database with this driver), this syntax is as follows:

```
jdbc:derby://host:port/databaseName;URLAttributes
```

With either syntax, `URLAttributes` is an optional sequence of semicolon-delimited `name=value` pairs. For example, `create=true` tells Java DB to create a new database.

The following example demonstrates the first syntax by telling JDBC to load the Java DB embedded driver and create the database named `testdb` on the local host:

```
Connection con = DriverManager.getConnection("jdbc:derby:testdb;create=true");
```

The following example demonstrates the second syntax by telling JDBC to load the Java DB client driver and create the database named `testdb` on port 8500 of the `xyz` host:

```
Connection con;  
con = DriverManager.getConnection("jdbc:derby://xyz:8500/testdb;create=true");
```

Consider SQLite. The Xerial project ([www.xerial.org/trac/Xerial](http://www.xerial.org/trac/Xerial)) provides the SQLite JDBC driver ([www.xerial.org/trac/Xerial/wiki/SQLiteJDBC](http://www.xerial.org/trac/Xerial/wiki/SQLiteJDBC)) for testing JDBC with SQLite. Point your browser to <https://bitbucket.org/xerial/sqlite-jdbc/downloads> and download an appropriate driver JAR file (such as `sqlite-jdbc-3.7.2.jar`).

For creating an actual file in which to store the database, the URL syntax for the Xerial SQLite driver is as follows:

```
jdbc:sqlite:databaseName
```

The following examples demonstrate this syntax for connecting to a database file (which is created when it doesn't exist) named `sample.db`:

```
Connection con1 = DriverManager.getConnection("jdbc:sqlite:sample.db");  
Connection con2 = DriverManager.getConnection("jdbc:sqlite:C:/temp/sample.db");
```

The first example obtains a connection to the current directory's `sample.db` file; the second example obtains a connection to a `sample.db` file in the `C:\temp` directory.

SQLite also supports in-memory database management, which doesn't create any database files. The following example shows you how to connect to an existing in-memory database:

```
Connection con = DriverManager.getConnection("jdbc:sqlite::memory:");
```

The following example shows you how to create and obtain a connection to an in-memory database:

```
Connection con = DriverManager.getConnection("jdbc:sqlite:");
```

**Note** For the most part, this chapter's applications can be used with either the Java DB embedded driver connection syntax or the non-in-memory SQLite driver connection syntax.

## Exceptions

DriverManager's `getConnection()` methods (and other JDBC methods in the various JDBC interfaces) throw `java.sql.SQLException` or one of its subclasses when something goes wrong. Along with the methods it inherits from `java.lang.Throwable` (such as `String getMessage()`), `SQLException` declares various constructors (not discussed for brevity) and the following methods:

- `int getErrorCode()` returns a vendor-specific integer error code. Normally this value will be the actual error code returned by the underlying data source.
- `SQLException getNextException()` returns the `SQLException` instance chained to this `SQLException` object (via a call to `setNextException(SQLException ex)`) or null when there isn't a chained exception.
- `String getSQLState()` returns a "SQLstate" string that provides an X/Open or SQL:1999 (see <http://en.wikipedia.org/wiki/SQL:1999>) error code identifying the exception.
- `Iterator<Throwable> iterator()` returns an iterator over the chained `SQLException`s and their causes in proper order. The iterator will be used to iterate over each `SQLException` and its underlying cause (if any). You would normally not call this method but would instead use the enhanced for statement (discussed in Chapter 9), which calls `iterator()` when you need to iterate over the chain of `SQLException`s. (The Android documentation at the current time of writing reports this method to be obsolete.)
- `void setNextException(SQLException sqlEx)` appends `sqlEx` to the end of the chain. (The Android documentation at the current time of writing reports this method to be obsolete.)

One or more `SQLException`s might occur while processing a request, and the code that throws these exceptions can add them to a *chain* of `SQLException`s by invoking `setNextException()`. Also, an `SQLException` instance might be thrown as a result of a different exception (`java.io.IOException`, for example) which is known as that exception's *cause* (see Chapter 5).

SQL state error codes are defined by the ISO/ANSI and Open Group (X/Open) SQL standards. The error code is a five-character string consisting of a two-character class value followed by a three-character subclass value. Class value "00" indicates success, class value "01" indicates a warning, and other class values normally indicate an exception. Examples of SQL state error codes are 00000 (success) and 08001 (unable to connect to the data source).

Listing 14-1 presents a framework for structuring a JDBC application that connects to a JDBC or SQLite data source, performs some work, and responds to a thrown `SQLException` instance.

*Listing 14-1. Architecting a Basic JDBC Application*

```
import java.sql.Connection;
import java.sql.DriverManager;
import java.sql.SQLException;

public class JDBCdemo
{
    final static String URL1 = "jdbc:derby:employee;create=true";
    final static String URL2 = "jdbc:sqlite:employee";

    public static void main(String[] args)
    {
        String url = null;
        if (args.length != 1)
        {
            System.err.println("usage 1: java JDBCdemo javadb");
            System.err.println("usage 2: java JDBCdemo sqlite");
            return;
        }
        if (args[0].equals("javadb"))
            url = URL1;
        else
            if (args[0].equals("sqlite"))
                url = URL2;
            else
            {
                System.err.println("invalid command-line argument");
                return;
            }
        Connection con = null;
        try
        {
            if (args[0].equals("sqlite"))
                Class.forName("org.sqlite.JDBC");
            con = DriverManager.getConnection(url);
            // Perform useful work. The following throw statement simulates a
            // JDBC method throwing SQLException.
            throw new SQLException("Unable to access database table",
                new java.io.IOException("File I/O problem"));
        }
        catch (ClassNotFoundException cnfe)
        {
            System.err.println("unable to load sqlite driver");
        }
    }
}
```

```

catch (SQLException sqlex)
{
    while (sqlex != null)
    {
        System.err.println("SQL error : " + sqlex.getMessage());
        System.err.println("SQL state : " + sqlex.getSQLState());
        System.err.println("Error code: " + sqlex.getErrorCode());
        System.err.println("Cause: " + sqlex.getCause());
        sqlex = sqlex.getNextException();
    }
}
finally
{
    if (con != null)
        try
        {
            con.close();
        }
        catch (SQLException sqle)
        {
            sqle.printStackTrace();
        }
}
}
}
}

```

Listing 14-1 requires that you run this application with the `javadb` or `sqlite` command-line argument. This argument determines which JDBC driver to use. If you specify `sqlite` as the argument, `Serial` requires that the SQLite driver classfile be explicitly loaded, and this task is accomplished via the `Class.forName("org.sqlite.JDBC")` method call.

Next, a connection to the data source is obtained. When successful, `IOException` and `SQLException` objects are created, and the `IOException` instance is wrapped inside the `SQLException` instance (as its cause), which is subsequently thrown. The catch block that handles the SQL exception uses a while loop to demonstrate outputting the SQL exception and all chained exceptions.

Connections must be closed when no longer needed. `Connection` declares a void `close()` method for this purpose. This method is documented to throw `SQLException`.

Compile Listing 14-1 via the following command line:

```
javac JDBCdemo.java
```

Run this application via the following command line:

```
java JDBCdemo javadb
```



Assuming that Java DB hasn't been configured (by setting the `DERBY_HOME` and `CLASSPATH` environment variables), you should expect the following output:

```
SQL error : No suitable driver found for jdbc:derby:employee;create=true
SQL state : 08001
Error code: 0
Cause: null
```

Set the `DERBY_HOME` environment variable, and then execute `setEmbeddedCP` to install Java DB's embedded driver. Then re-execute `java JDBCdemo javadb`. This time, you should observe the following correct output:

```
SQL error : Unable to access database table
SQL state : null
Error code: 0
Cause: java.io.IOException: File I/O problem
```

Furthermore, an `employee` directory containing the database and a `derby.log` file should appear in the current directory.

Now, run this application via the following command:

```
java JDBCdemo sqlite
```

Assuming that SQLite hasn't been configured, you should observe the following output:

```
unable to load sqlite driver
```

This error message results from the thrown `java.lang.ClassNotFoundException` instance. This exception was thrown from the `Class.forName("org.sqlite.JDBC")` method call that attempted to load a nonexistent driver classfile.

You need to add the Xerial SQLite driver to the classpath when running `JDBCdemo`. Accomplish this task via the following command line:

```
java -cp sqlite-jdbc-3.7.2.jar;. JDBCdemo sqlite
```

Because of the previously created `employee` directory, you should observe the following output:

```
SQL error : [SQLITE_CANTOPEN] Unable to open the database file (out of memory)
SQL state : null
Error code: 0
Cause: null
```

Remove the `employee` directory (and `derby.log` for neatness) and re-execute the aforementioned command line. This time, you should observe the following correct output:

```
SQL error : Unable to access database table
SQL state : null
Error code: 0
Cause: java.io.IOException: File I/O problem
```

SQLException declares several subclasses (such as `java.sql.BatchUpdateException`—an error has occurred during a batch update operation). Many of these subclasses are categorized under `java.sql.SQLNonTransientException`- and `java.sql.SQLTransientException`-rooted class hierarchies in which `SQLNonTransientException` describes failed operations that cannot be retried without changing application source code or some aspect of the data source, and `SQLTransientException` describes failed operations that can be retried immediately.

## Statements

After obtaining a connection to a data source, an application interacts with the data source by issuing SQL statements (such as `CREATE TABLE`, `INSERT`, `SELECT`, `UPDATE`, `DELETE`, and `DROP TABLE`). JDBC supports SQL statements via the `java.sql.Statement`, `java.sql.PreparedStatement`, and `java.sql.CallableStatement` interfaces. Furthermore, `Connection` declares various `createStatement()`, `prepareStatement`, and `prepareCall()` methods that return `Statement`, `PreparedStatement`, or `CallableStatement` implementation instances, respectively.

## Statement and ResultSet

`Statement` is the easiest-to-use interface, and `Connection`'s `Statement` `createStatement()` method is the easiest-to-use method for obtaining a `Statement` instance. After calling this method, you can execute various SQL statements by invoking `Statement` methods such as the following:

- `ResultSet executeQuery(String sql)` executes a `SELECT` statement and (assuming no exception is thrown) provides access to its results via a `java.sql.ResultSet` instance.
- `int executeUpdate(String sql)` executes a `CREATE TABLE`, `INSERT`, `UPDATE`, `DELETE`, or `DROP TABLE` statement and (assuming no exception is thrown) typically returns the number of table rows affected by this statement.

I've created a second `JDBCDemo` application that demonstrates these methods. Listing 14-2 presents its source code.

*Listing 14-2. Creating, Inserting Values into, Querying, and Dropping an EMPLOYEES Table*

```
import java.sql.Connection;
import java.sql.DriverManager;
import java.sql.ResultSet;
import java.sql.SQLException;
import java.sql.Statement;

public class JDBCDemo
{
    final static String URL1 = "jdbc:derby:employee;create=true";
    final static String URL2 = "jdbc:sqlite:employee";

    public static void main(String[] args)
    {
        String url = null;
        if (args.length != 1)
```

```
{
    System.err.println("usage 1: java JDBCdemo javadb");
    System.err.println("usage 2: java JDBCdemo sqlite");
    return;
}
if (args[0].equals("javadb"))
    url = URL1;
else
if (args[0].equals("sqlite"))
    url = URL2;
else
{
    System.err.println("invalid command-line argument");
    return;
}
Connection con = null;
try
{
    if (args[0].equals("sqlite"))
        Class.forName("org.sqlite.JDBC");
    con = DriverManager.getConnection(url);
    Statement stmt = null;
    try
    {
        stmt = con.createStatement();
        String sql = "CREATE TABLE EMPLOYEES(ID INTEGER, NAME VARCHAR(30))";
        stmt.executeUpdate(sql);
        sql = "INSERT INTO EMPLOYEES VALUES(1, 'John Doe')";
        stmt.executeUpdate(sql);
        sql = "INSERT INTO EMPLOYEES VALUES(2, 'Sally Smith')";
        stmt.executeUpdate(sql);
        ResultSet rs = stmt.executeQuery("SELECT * FROM EMPLOYEES");
        while (rs.next())
            System.out.println(rs.getInt("ID") + " " + rs.getString("NAME"));
        stmt.executeUpdate("DROP TABLE EMPLOYEES");
    }
    catch (SQLException sqllex)
    {
        while (sqllex != null)
        {
            System.err.println("SQL error : " + sqllex.getMessage());
            System.err.println("SQL state : " + sqllex.getSQLState());
            System.err.println("Error code: " + sqllex.getErrorCode());
            System.err.println("Cause: " + sqllex.getCause());
            sqllex = sqllex.getNextException();
        }
    }
}
```

```

    finally
    {
        if (stmt != null)
            try
            {
                stmt.close();
            }
            catch (SQLException sqle)
            {
                sqle.printStackTrace();
            }
    }
}
catch (ClassNotFoundException cnfe)
{
    System.err.println("unable to load sqlite driver");
}
catch (SQLException sqlex)
{
    while (sqlex != null)
    {
        System.err.println("SQL error : " + sqlex.getMessage());
        System.err.println("SQL state : " + sqlex.getSQLState());
        System.err.println("Error code: " + sqlex.getErrorCode());
        System.err.println("Cause: " + sqlex.getCause());
        sqlex = sqlex.getNextException();
    }
}
finally
{
    if (con != null)
        try
        {
            con.close();
        }
        catch (SQLException sqle)
        {
            sqle.printStackTrace();
        }
}
}
}

```

Listing 14-2 presents a similar architecture to Listing 14-1. For brevity, I won't repeat the same instructions and examples that I presented while discussing SQL exceptions. Instead, I prefer to focus on new aspects of JDBC.

After successfully establishing a connection to the employee data source, `main()` creates a statement and uses it to execute SQL statements for creating, inserting values into, querying, and dropping an `EMPLOYEES` table.

The `executeQuery()` method returns a `ResultSet` object that provides access to a query's tabular results. Each result set is associated with a *cursor* that provides access to a specific row of data. The cursor initially points before the first row; call `ResultSet`'s `boolean next()` method to advance the cursor to the next row. As long as there's a next row, this method returns `true`; it returns `false` when there are no more rows to examine.

`ResultSet` also declares various methods for returning the current row's column values based on their types. For example, `int getInt(String columnLabel)` returns the integer value corresponding to the `INTEGER`-based column identified by `columnLabel`. Similarly, `String getString(String columnLabel)` returns the string value corresponding to the `VARCHAR`-based column identified by `columnLabel`.

**Tip** If you don't have column names but have one-based column indexes, call `ResultSet` methods such as `int getInt(int columnIndex)` and `String getString(int columnIndex)`. However, best practice is to call `int getInt(String columnLabel)`.

Compile Listing 14-2 and run this application as previously discussed—you will want to first delete the employee directory/file left behind by the previous application. You should observe the following output:

```
1 John Doe
2 Sally Smith
```

SQL's `INTEGER` and `VARCHAR` types map to Java's `int` and `java.lang.String` types. Table 14-1 presents a more complete list of type mappings.

**Table 14-1.** SQL Type/Java Type Mappings

SQL Type	Java Type
ARRAY	<code>java.sql.Array</code>
BIGINT	<code>Long</code>
BINARY	<code>byte[]</code>
BIT	<code>Boolean</code>
BLOB	<code>java.sql.Blob</code>
BOOLEAN	<code>Boolean</code>
CHAR	<code>java.lang.String</code>
CLOB	<code>java.sql.Clob</code>
DATE	<code>java.sql.Date</code>
DECIMAL	<code>java.math.BigDecimal</code>
DOUBLE	<code>Double</code>

(continued)

**Table 14-1.** (continued)

SQL Type	Java Type
FLOAT	Double
INTEGER	Int
LONGVARBINARY	byte[]
LONGVARCHAR	java.lang.String
NUMERIC	java.math.BigDecimal
REAL	Float
REF	java.sql.Ref
SMALLINT	Short
STRUCT	java.sql.Struct
TIME	java.sql.Time
TIMESTAMP	java.sql.Timestamp
TINYINT	Byte
VARBINARY	byte[]
VARCHAR	java.lang.String

Check out <http://docs.oracle.com/javase/1.5.0/docs/guide/jdbc/getstart/mapping.html> for more information on type mappings.

## PreparedStatement

PreparedStatement is the next easiest-to-use interface, and Connection's PreparedStatement prepareStatement() method is the easiest-to-use method for obtaining a PreparedStatement instance—PreparedStatement is a subinterface of Statement.

Unlike a regular statement, a *prepared statement* represents a precompiled SQL statement. The SQL statement is compiled to improve performance and prevent *SQL injection* (see [http://en.wikipedia.org/wiki/SQL\\_injection](http://en.wikipedia.org/wiki/SQL_injection)), and the compiled result is stored in a PreparedStatement implementation instance.

You typically obtain this instance when you want to execute the same prepared statement multiple times. For example, you want to execute an SQL INSERT statement multiple times to populate a database table. Consider Listing 14-3.

**Listing 14-3.** Creating, Inserting Values via a Prepared Statement into, Querying, and Dropping an EMPLOYEES Table

```
import java.sql.Connection;
import java.sql.DriverManager;
import java.sql.PreparedStatement;
import java.sql.ResultSet;
import java.sql.SQLException;
import java.sql.Statement;
```

```
public class JDBCdemo
{
    final static String URL1 = "jdbc:derby:employee;create=true";
    final static String URL2 = "jdbc:sqlite:employee";

    public static void main(String[] args)
    {
        String url = null;
        if (args.length != 1)
        {
            System.err.println("usage 1: java JDBCdemo javadb");
            System.err.println("usage 2: java JDBCdemo sqlite");
            return;
        }
        if (args[0].equals("javadb"))
            url = URL1;
        else
            if (args[0].equals("sqlite"))
                url = URL2;
            else
            {
                System.err.println("invalid command-line argument");
                return;
            }
        Connection con = null;
        try
        {
            if (args[0].equals("sqlite"))
                Class.forName("org.sqlite.JDBC");
            con = DriverManager.getConnection(url);
            Statement stmt = null;
            try
            {
                stmt = con.createStatement();
                String sql = "CREATE TABLE EMPLOYEES(ID INTEGER, NAME VARCHAR(30))";
                stmt.executeUpdate(sql);
                PreparedStatement pstmt = null;
                try
                {
                    pstmt = con.prepareStatement("INSERT INTO EMPLOYEES VALUES(?, ?)");
                    String[] empNames = { "John Doe", "Sally Smith" };
                    for (int i = 0; i < empNames.length; i++)
                    {
                        pstmt.setInt(1, i+1);
                        pstmt.setString(2, empNames[i]);
                        pstmt.executeUpdate();
                    }
                }
                ResultSet rs = stmt.executeQuery("SELECT * FROM EMPLOYEES");
                while (rs.next())
                    System.out.println(rs.getInt("ID") + " " + rs.getString("NAME"));
                stmt.executeUpdate("DROP TABLE EMPLOYEES");
            }
        }
    }
}
```

```
catch (SQLException sqllex)
{
    while (sqllex != null)
    {
        System.err.println("SQL error : " + sqllex.getMessage());
        System.err.println("SQL state : " + sqllex.getSQLState());
        System.err.println("Error code: " + sqllex.getErrorCode());
        System.err.println("Cause: " + sqllex.getCause());
        sqllex = sqllex.getNextException();
    }
}
finally
{
    if (pstmt != null)
    try
    {
        pstmt.close();
    }
    catch (SQLException sqle)
    {
        sqle.printStackTrace();
    }
}
}
catch (SQLException sqllex)
{
    while (sqllex != null)
    {
        System.err.println("SQL error : " + sqllex.getMessage());
        System.err.println("SQL state : " + sqllex.getSQLState());
        System.err.println("Error code: " + sqllex.getErrorCode());
        System.err.println("Cause: " + sqllex.getCause());
        sqllex = sqllex.getNextException();
    }
}
finally
{
    if (stmt != null)
    try
    {
        stmt.close();
    }
    catch (SQLException sqle)
    {
        sqle.printStackTrace();
    }
}
}
```



```

catch (ClassNotFoundException cnfe)
{
    System.err.println("unable to load sqlite driver");
}
catch (SQLException sqllex)
{
    while (sqllex != null)
    {
        System.err.println("SQL error : " + sqllex.getMessage());
        System.err.println("SQL state : " + sqllex.getSQLState());
        System.err.println("Error code: " + sqllex.getErrorCode());
        System.err.println("Cause: " + sqllex.getCause());
        sqllex = sqllex.getNextException();
    }
}
finally
{
    if (con != null)
        try
        {
            con.close();
        }
        catch (SQLException sqle)
        {
            sqle.printStackTrace();
        }
}
}
}

```

Listing 14-3 creates a `String` object that specifies an SQL `INSERT` statement. Each “?” character serves as a placeholder for a value that’s specified before the statement is executed.

After the `PreparedStatement` implementation instance has been obtained, this interface’s `void setInt(int parameterIndex, int x)` and `void setString(int parameterIndex, String x)` methods are called on this instance to provide these values (the first argument passed to each method is a 1-based integer column index into the table associated with the statement—1 corresponds to the leftmost column), and then `PreparedStatement`’s `int executeUpdate()` method is called to execute this SQL statement. The end result is that a pair of rows containing John Doe, Sally Smith, and their respective identifiers is added to the `EMPLOYEES` table.

## CallableStatement

`CallableStatement` is the most specialized of the statement interfaces; it extends `PreparedStatement`. You use this interface to execute SQL stored procedures in which a *stored procedure* is a list of SQL statements that perform a specific task (such as fire an employee). Java DB differs from other RDBMSs in that a stored procedure’s body is implemented as a `public static` Java method. Furthermore, the class in which this method is declared must be `public`.

**Note** SQLite doesn't support stored procedures.

You create a stored procedure by executing an SQL statement that typically begins with CREATE PROCEDURE and then continues with RDBMS-specific syntax. For example, the Java DB syntax for creating a stored procedure, as specified on the web page at <http://db.apache.org/derby/docs/10.8/ref/rrefcreateprocedurestatement.html>, is as follows:

```
CREATE PROCEDURE procedure-name ([ procedure-parameter [, procedure-parameter ] ]*)
[ procedure-element ]*
```

*procedure-name* is expressed as

```
[ schemaName . ] SQL92Identifier
```

*procedure-parameter* is expressed as

```
[ { IN | OUT | INOUT } ] [ parameter-Name ] DataType
```

*procedure-element* is expressed as

```
{
| [ DYNAMIC ] RESULT SETS INTEGER
| LANGUAGE { JAVA }
| DeterministicCharacteristic
| EXTERNAL NAME string
| PARAMETER STYLE JAVA
| EXTERNAL SECURITY { DEFINER | INVOKER }
| { NO SQL | MODIFIES SQL DATA | CONTAINS SQL | READS SQL DATA }
}
```

Anything between [ ] is optional, the \* to the right of [ ] indicates that anything between these metacharacters can appear zero or more times, the { } metacharacters surround a list of items, and | separates possible items—only one of these items can be specified.

For example, CREATE PROCEDURE FIRE(IN ID INTEGER) PARAMETER STYLE JAVA LANGUAGE JAVA DYNAMIC RESULT SETS 0 EXTERNAL NAME 'JDBCDemo.fire' creates a stored procedure named FIRE. This procedure specifies an input parameter named ID and is associated with a public static method named fire in a public class named JDBCDemo.

After creating the stored procedure, you need to obtain a CallableStatement implementation instance in order to call that procedure, and you do so by invoking one of Connection's prepareCall() methods; for example, CallableStatement prepareCall(String sql).

The string passed to prepareCall() is an *escape clause* (RDBMS-independent syntax) consisting of an open {, followed by the word call, followed by a space, followed by the name of the stored procedure, followed by a parameter list with "?" placeholder characters for the arguments that will be passed, followed by a closing }.

**Note** Escape clauses are JDBC's way of smoothing out some of the differences in how different RDBMS vendors implement SQL. When a JDBC driver detects escape syntax, it converts it into the code that the particular RDBMS understands. This makes escape syntax RDBMS independent.

Once you have a `CallableStatement` reference, you pass arguments to these parameters in the same way as with `PreparedStatement`. The following example demonstrates:

```
CallableStatement cstmt = null;
try
{
    cstmt = con.prepareCall("{ call FIRE(?)}")
    cstmt.setInt(1, 2);
    cstmt.execute();
}
catch (SQLException sqle)
{
    // handle the exception
}
finally
{
    // close the callable statement
}
```

The `cstmt.setInt(1, 2)` method call assigns 2 to the leftmost stored procedure parameter—parameter index 1 corresponds to the leftmost parameter (or to a single parameter when there's only one). The `cstmt.execute()` method call executes the stored procedure, which results in a callback to the application's public static void `fire(int id)` method.

I've created another version of the `JDBCDemo` application that demonstrates this callable statement in a Java DB context only. Listing 14-4 presents its source code.

*Listing 14-4. Firing an Employee via a Stored Procedure*

```
import java.sql.CallableStatement;
import java.sql.Connection;
import java.sql.DriverManager;
import java.sql.ResultSet;
import java.sql.SQLException;
import java.sql.Statement;

public class JDBCDemo
{
    public static void main(String[] args)
    {
        String url = "jdbc:derby:employee;create=true";
        Connection con = null;
        try
```

```

{
    con = DriverManager.getConnection(url);
    Statement stmt = null;
    try
    {
        stmt = con.createStatement();
        String sql = "CREATE PROCEDURE FIRE(IN ID INTEGER)" +
            "    PARAMETER STYLE JAVA" +
            "    LANGUAGE JAVA" +
            "    DYNAMIC RESULT SETS 0" +
            "    EXTERNAL NAME 'JDBCDemo.fire'";
        stmt.executeUpdate(sql);
        sql = "CREATE TABLE EMPLOYEES(ID INTEGER, NAME VARCHAR(30), " +
            "    FIRED BOOLEAN)";
        stmt.executeUpdate(sql);
        sql = "INSERT INTO EMPLOYEES VALUES(1, 'John Doe', false)";
        stmt.executeUpdate(sql);
        sql = "INSERT INTO EMPLOYEES VALUES(2, 'Sally Smith', false)";
        stmt.executeUpdate(sql);
        dump(stmt.executeQuery("SELECT * FROM EMPLOYEES"));
        CallableStatement cstmt = null;
        try
        {
            cstmt = con.prepareCall("{ call FIRE(?)}");
            cstmt.setInt(1, 2);
            cstmt.execute();
            dump(stmt.executeQuery("SELECT * FROM EMPLOYEES"));
            stmt.executeUpdate("DROP TABLE EMPLOYEES");
            stmt.executeUpdate("DROP PROCEDURE FIRE");
        }
        catch (SQLException sqllex)
        {
            while (sqllex != null)
            {
                System.err.println("SQL error : " + sqllex.getMessage());
                System.err.println("SQL state : " + sqllex.getSQLState());
                System.err.println("Error code: " + sqllex.getErrorCode());
                System.err.println("Cause: " + sqllex.getCause());
                sqllex = sqllex.getNextException();
            }
        }
    }
    finally
    {
        if (cstmt != null)
            try
            {
                cstmt.close();
            }
    }
}

```

```
        catch (SQLException sqle)
        {
            sqle.printStackTrace();
        }
    }
}
catch (SQLException sqlex)
{
    while (sqlex != null)
    {
        System.err.println("SQL error : " + sqlex.getMessage());
        System.err.println("SQL state : " + sqlex.getSQLState());
        System.err.println("Error code: " + sqlex.getErrorCode());
        System.err.println("Cause: " + sqlex.getCause());
        sqlex = sqlex.getNextException();
    }
}
finally
{
    if (stmt != null)
    try
    {
        stmt.close();
    }
    catch (SQLException sqle)
    {
        sqle.printStackTrace();
    }
}
}
catch (SQLException sqlex)
{
    while (sqlex != null)
    {
        System.err.println("SQL error : " + sqlex.getMessage());
        System.err.println("SQL state : " + sqlex.getSQLState());
        System.err.println("Error code: " + sqlex.getErrorCode());
        System.err.println("Cause: " + sqlex.getCause());
        sqlex = sqlex.getNextException();
    }
}
finally
{
    if (con != null)
    try
    {
        con.close();
    }
}
```

```

        catch (SQLException sqle)
        {
            sqle.printStackTrace();
        }
    }
}

static void dump(ResultSet rs) throws SQLException
{
    StringBuilder sb = new StringBuilder();
    while (rs.next())
    {
        sb.append(rs.getInt("ID"));
        sb.append(' ');
        sb.append(rs.getString("NAME"));
        sb.append(' ');
        sb.append(rs.getBoolean("FIRED"));
        System.out.println(sb);
        sb.setLength(0);
    }
    System.out.println();
}

public static void fire(int id) throws SQLException
{
    Connection con = DriverManager.getConnection("jdbc:default:connection");
    String sql = "UPDATE EMPLOYEES SET FIRED=TRUE WHERE ID=" + id;
    Statement stmt = null;
    try
    {
        stmt = con.createStatement();
        stmt.executeUpdate(sql);
    }
    finally
    {
        if (stmt != null)
            try
            {
                stmt.close();
            }
            catch (SQLException sqle)
            {
                sqle.printStackTrace();
            }
    }
}
}
}

```

Much of 14-4 should be fairly understandable so I'll only discuss the `fire()` method. As previously stated, this method is invoked as a result of the callable statement invocation.

`fire()` is called with the integer identifier of the employee to fire. It first accesses the current `Connection` object by invoking `getConnection()` with the `jdbc.default:connection` argument, which is supported by Oracle virtual machines through a special internal driver.

After creating an SQL `UPDATE` statement string to set the `FIRE` column to true in the `EMPLOYEES` table row where its `ID` field equals the value in `id`, `fire()` invokes `executeUpdate()` to update the table appropriately.

Compile Listing 14-4 (`javac JDBCdemo.java`) and run this application (`java JDBCdemo`). You should observe the following output:

```
1 John Doe false
2 Sally Smith false
```

```
1 John Doe false
2 Sally Smith true
```

## Metadata

A data source is typically associated with *metadata* (data about data) that describes the data source. When the data source is an RDBMS, this data is typically stored in a collection of tables.

Metadata includes a list of *catalogs* (RDBMS databases whose tables describe RDBMS objects such as *base tables* [tables that physically exist], *views* [virtual tables], and *indexes* [files that improve the speed of data retrieval operations]), *schemas* (namespaces that partition database objects), and additional information (such as version numbers, identification strings, and limits).

To access a data source's metadata, invoke `Connection`'s `DatabaseMetaData` `getMetaData()` method. This method returns an implementation instance of the `java.sql.DatabaseMetaData` interface.

I've created yet another `JDBCdemo` application that demonstrates `getMetaData()` and various `DatabaseMetaData` methods in the context of Java DB. Listing 14-5 presents `Metadata`'s source code.

### Listing 14-5. Obtaining Metadata from an Employee Data Source

```
import java.sql.Connection;
import java.sql.DatabaseMetaData;
import java.sql.DriverManager;
import java.sql.ResultSet;
import java.sql.SQLException;
import java.sql.Statement;

public class JDBCdemo
{
    public static void main(String[] args)
    {
        String url = "jdbc:derby:employee;create=true";
        Connection con = null;
        try
        {
            con = DriverManager.getConnection(url);
            dump(con.getMetaData());
        }
    }
}
```

```

catch (SQLException sqllex)
{
    while (sqllex != null)
    {
        System.err.println("SQL error : " + sqllex.getMessage());
        System.err.println("SQL state : " + sqllex.getSQLState());
        System.err.println("Error code: " + sqllex.getErrorCode());
        System.err.println("Cause: " + sqllex.getCause());
        sqllex = sqllex.getNextException();
    }
}
finally
{
    if (con != null)
        try
        {
            con.close();
        }
        catch (SQLException sqle)
        {
            sqle.printStackTrace();
        }
}
}

static void dump(DatabaseMetaData dbmd) throws SQLException
{
    System.out.println("DB Major Version = " + dbmd.getDatabaseMajorVersion());
    System.out.println("DB Minor Version = " + dbmd.getDatabaseMinorVersion());
    System.out.println("DB Product = " + dbmd.getDatabaseProductName());
    System.out.println("Driver Name = " + dbmd.getDriverName());
    System.out.println("Numeric function names for escape clause = " +
        dbmd.getNumericFunctions());
    System.out.println("String function names for escape clause = " +
        dbmd.getStringFunctions());
    System.out.println("System function names for escape clause = " +
        dbmd.getSystemFunctions());
    System.out.println("Time/date function names for escape clause = " +
        dbmd.getTimeDateFunctions());
    System.out.println("Catalog term: " + dbmd.getCatalogTerm());
    System.out.println("Schema term: " + dbmd.getSchemaTerm());
    System.out.println();
    System.out.println("Catalogs");
    System.out.println("-----");
    ResultSet rsCat = dbmd.getCatalogs();
    while (rsCat.next())
        System.out.println(rsCat.getString("TABLE_CAT"));
    System.out.println();
    System.out.println("Schemas");
    System.out.println("-----");
    ResultSet rsSchem = dbmd.getSchemas());
}

```



```

while (rsSchem.next())
    System.out.println(rsSchem.getString("TABLE_SCHEM"));
System.out.println();
System.out.println("Schema/Table");
System.out.println("-----");
rsSchem = dbmd.getSchemas();
while (rsSchem.next())
{
    String schem = rsSchem.getString("TABLE_SCHEM");
    ResultSet rsTab = dbmd.getTables(null, schem, "%", null);
    while (rsTab.next())
        System.out.println(schem + " " + rsTab.getString("TABLE_NAME"));
    }
}
}

```

Listing 14-5's `dump()` method invokes various methods on its `dbmd` argument to output assorted metadata.

The `int getDatabaseMajorVersion()` and `int getDatabaseMinorVersion()` methods return the major (such as 10) and minor (such as 8) parts of Java DB's version number. Similarly, `String getDatabaseProductName()` returns the name of this product (such as Apache Derby), and `String getDriverName()` returns the name of the driver (such as Apache Derby Embedded JDBC Driver).

SQL defines various functions that can be invoked as part of `SELECT` and other statements. For example, you can specify `SELECT COUNT(*) AS TOTAL FROM EMPLOYEES` to return a one-row-by-one-column result set with the column named `TOTAL` and the row value containing the number of rows in the `EMPLOYEES` table.

Because not all RDMSES adopt the same syntax for specifying function calls, JDBC uses a *function escape clause*, consisting of `{ fn functionname(arguments) }`, to abstract over differences. For example, `SELECT {fn UCASE(NAME)} FROM EMPLOYEES` selects all `NAME` column values from `EMPLOYEES` and uppercases their values in the result set.

The `String getNumericFunctions()`, `String getStringFunctions()`, `String getSystemFunctions()`, and `String getTimeDateFunctions()` methods return lists of function names that can appear in function escape clauses. For example, `getNumericFunctions()` returns `ABS, ACOS, ASIN, ATAN, ATAN2, CEILING, COS, COT, DEGREES, EXP, FLOOR, LOG, LOG10, MOD, PI, RADIANS, RAND, SIGN, SIN, SQRT, TAN` for Java DB 10.8.

Not all vendors use the same terminology for catalog and schema. For this reason, the `String getCatalogTerm()` and `String getSchemaTerm()` methods are present to return the vendor-specific terms, which happen to be `CATALOG` and `SCHEMA` for Java DB 10.8.

The `ResultSet getCatalogs()` method returns a result set of catalog names, which are accessible via the result set's `TABLE_CAT` column. This result set is empty for Java DB 10.8, which divides a single default catalog into various schemas.

The `ResultSet getSchemas()` method returns a result set of schema names, which are accessible via the result set's `TABLE_SCHEM` column. This column contains `APP, NULLID, SQLJ, SYS, SYSCAT, SYSCS_DIAG, SYSCS_UTIL, SYSFUN, SYSIBM, SYSPROC, and SYSSTAT` values for Java DB 10.8. `APP` is the default schema in which a user's database objects are stored.

The `ResultSet` `getTables(String catalog, String schemaPattern, String tableNamePattern, String[] types)` method returns a result set containing table names (in the `TABLE_NAME` column) and other table-oriented metadata that match the specified catalog, `schemaPattern`, `tableNamePattern`, and `types`. To obtain a result set of all tables for a specific schema, pass null to `catalog` and `types`, the schema name to `schemaPattern`, and the `%` wildcard to `tableNamePattern`.

For example, the `SYS` schema stores `SYSALIASES`, `SYSCHECKS`, `SYSCOLPERMS`, `SYSCOLUMNS`, `SYSCONGLOMERATES`, `SYSCONSTRAINTS`, `SYSDEPENDS`, `SYSFILES`, `SYSFOREIGNKEYS`, `SYSKEYS`, `SYSPERMS`, `SYSROLES`, `SYSROUTINEPERMS`, `SYSSCHEMAS`, `SYSSEQUENCES`, `SYSSTATEMENTS`, `SYSSTATISTICS`, `SYSTABLEPERMS`, `SYSTABLES`, `SYSTRIGGERS`, and `SYSVIEWS` tables.

Listings 14-2 through 14-4 suffer from an architectural problem. After creating the `EMPLOYEES` table, suppose that `SQLException` is thrown before the table is dropped. The next time the `JDBCDemo` application runs (under Java DB), `SQLException` is thrown when the application attempts to recreate `EMPLOYEES` because this table already exists. You have to manually delete the employee directory before you can rerun `JDBCDemo`.

It would be nice to call an `isExist()` function before creating `EMPLOYEES`, but that function doesn't exist. However, you can create a same-named method with help from `getTables()`, and Listing 14-6 shows you how to accomplish this task.

*Listing 14-6. Determining the Existence of EMPLOYEES Before Creating This Table*

```
import java.sql.Connection;
import java.sql.DatabaseMetaData;
import java.sql.DriverManager;
import java.sql.ResultSet;
import java.sql.SQLException;
import java.sql.Statement;

public class JDBCDemo
{
    public static void main(String[] args)
    {
        String url = "jdbc:derby:employee;create=true";
        Connection con = null;
        try
        {
            con = DriverManager.getConnection(url);
            Statement stmt = null;
            try
            {
                stmt = con.createStatement();
                String sql;
                if (!isExist(con, "EMPLOYEES"))
                {
                    System.out.println("EMPLOYEES doesn't exist");
                    sql = "CREATE TABLE EMPLOYEES(ID INTEGER, NAME VARCHAR(30))";
                    stmt.executeUpdate(sql);
                }
            }
        }
    }
}
```

```

else
    System.out.println("EMPLOYEES already exists");
    sql = "INSERT INTO EMPLOYEES VALUES(1, 'John Doe')";
    stmt.executeUpdate(sql);
    sql = "INSERT INTO EMPLOYEES VALUES(2, 'Sally Smith')";
    stmt.executeUpdate(sql);
    ResultSet rs = stmt.executeQuery("SELECT * FROM EMPLOYEES");
    while (rs.next())
        System.out.println(rs.getInt("ID") + " " + rs.getString("NAME"));
    stmt.executeUpdate("DROP TABLE EMPLOYEES");
}
catch (SQLException sqllex)
{
    while (sqllex != null)
    {
        System.err.println("SQL error : " + sqllex.getMessage());
        System.err.println("SQL state : " + sqllex.getSQLState());
        System.err.println("Error code: " + sqllex.getErrorCode());
        System.err.println("Cause: " + sqllex.getCause());
        sqllex = sqllex.getNextException();
    }
}
finally
{
    if (stmt != null)
        try
        {
            stmt.close();
        }
        catch (SQLException sqle)
        {
            sqle.printStackTrace();
        }
}
}
catch (SQLException sqllex)
{
    while (sqllex != null)
    {
        System.err.println("SQL error : " + sqllex.getMessage());
        System.err.println("SQL state : " + sqllex.getSQLState());
        System.err.println("Error code: " + sqllex.getErrorCode());
        System.err.println("Cause: " + sqllex.getCause());
        sqllex = sqllex.getNextException();
    }
}
finally
{
    if (con != null)
        try

```

```

        {
            con.close();
        }
        catch (SQLException sqle)
        {
            sqle.printStackTrace();
        }
    }
}

static boolean isExist(Connection con, String tableName) throws SQLException
{
    DatabaseMetaData dbmd = con.getMetaData();
    ResultSet rs = dbmd.getTables(null, "APP", tableName, null);
    return rs.next();
}
}

```

Listing 14-6 refactors Listing 14-2 (from a Java DB perspective only) by introducing a boolean `isExist(Connection con, String tableName)` class method, which returns true when `tableName` exists, and using this method to determine the existence of `EMPLOYEES` before creating this table.

When the specified table exists, a `ResultSet` object containing one row is returned, and `ResultSet`'s `next()` method returns true. Otherwise, the result set contains no rows and `next()` returns false.

**Caution** `isExist()` assumes the default APP schema, which might not be the case when usernames are involved (each user's database objects are stored in a schema corresponding to the user's name).

## EXERCISES

The following exercises are designed to test your understanding of Chapter 14's content.

1. Define database.
2. What is a relational database?
3. Identify two other database categories.
4. Define database management system.
5. What is Java DB?
6. True or false: Java DB's client driver causes the database engine to run in the same virtual machine as the application.
7. What does `setEmbeddedCP` accomplish?
8. True or false: You run Java DB's `dblook` command-line tool to view the Java environment/Java DB configuration.

9. What is SQLite?
  10. Define manifest typing.
  11. What tool does SQLite provide for accessing and modifying SQLite databases?
  12. What is JDBC?
  13. Define data source.
  14. A JDBC driver implements what interface?
  15. True or false: There are three kinds of JDBC drivers.
  16. Describe a Type 3 JDBC driver.
  17. What types does JDBC provide for communicating with a data source?
  18. How do you obtain a connection to a Java DB data source via the embedded driver?
  19. True or false: `String getSQLState()` returns a vendor-specific error code.
  20. What is a SQL state error code?
  21. What is the difference between `SQLException` and `TransientSQLException`?
  22. Identify JDBC's three statement types.
  23. Which `Statement` method do you call to execute an SQL `SELECT` statement?
  24. What does a result set's cursor accomplish?
  25. To which Java type does the SQL `FLOAT` type map?
  26. What does a prepared statement represent?
  27. True or false: `CallableStatement` extends `PreparedStatement`.
  28. Define stored procedure.
  29. How do you call a stored procedure?
  30. What is an escape clause?
  31. Define metadata.
  32. What does metadata include?
  33. Refactor Listing 14-5 to output metadata for the SQLite driver as well as for the Java DB embedded driver.
-

## Summary

A database is an organized collection of data. Although there are many kinds of databases (such as hierarchical, object-oriented, and relational), relational databases, which organize data into tables that can be related to each other, are common.

Except for the most trivial of databases (such as Chapter 11's flat file database based on a single data file), databases are created and managed through a database management system. Relational DBMSs support SQL for working with tables and more.

First introduced by Sun Microsystems as part of JDK 6 (and not included in the JRE) to give developers an RDBMS to test their JDBC code, Java DB is a distribution of Apache's open-source Derby product, which is based on IBM's Cloudscape RDBMS code base.

Java DB is capable of running in an embedded environment or in a client/server environment. In an embedded environment, where an application accesses the database engine via Java DB's embedded driver, the database engine runs in the same virtual machine as the application.

In a client/server environment, client applications and the database engine run in separate virtual machines. A client application accesses the network server through Java DB's client driver. The network server, which runs in the same virtual machine as the database engine, accesses the database engine through the embedded driver.

SQLite is a self-contained, serverless, zero-configuration, transactional SQL database engine; it is considered to be the most widely deployed database engine in the world. For example, SQLite is found in Mozilla Firefox, Google Chrome, and other web browsers. It's also found in Google Android, Apple iOS, and other mobile operating systems.

The `sqlite3` executable offers a command-line shell for accessing and modifying SQLite databases. You can specify `sqlite3` with a database filename argument to create the database file when it doesn't exist (you must create a table at least) or open the existing file, and enter this tool's shell from where you can execute `sqlite3`-specific, dot-prefixed commands and SQL statements.

JDBC is an API for performing various database operations, such as submitting SQL statements that tell the RDBMS to create a table and to update or query tabular data. Although JDBC is typically used to communicate with RDBMSs, it also can be used to communicate with a flat file database. For this reason, JDBC uses the term data source to abstract the source of data.

Because data sources are accessed in different ways, JDBC uses drivers to abstract over their implementations. This abstraction lets you write an application that can be adapted to an arbitrary data source without having to change a single line of code (in most cases). Drivers are implementations of the `java.sql.Driver` interface. JDBC recognizes four types of drivers.

To connect to a data source and obtain a `Connection` instance, call one of `DriverManager`'s `getConnection()` methods. With either method, the `url` argument specifies a string-based URL that starts with the `jdbc:` prefix and continues with data source-specific syntax.

`DriverManager`'s `getConnection()` methods (and other JDBC methods in the various JDBC interfaces) throw `SQLException` or one of its subclasses when something goes wrong. Instances of this class provide vendor codes, SQL state strings, and other kinds of information.

After obtaining a connection to a data source, an application interacts with the data source by issuing SQL statements. JDBC supports SQL statements via the `Statement`, `PreparedStatement`, and `CallableStatement` interfaces.

The `executeQuery()` methods return a `ResultSet` object that provides access to a query's tabular results. Each result set is associated with a cursor that provides access to a specific row of data. The cursor initially points before the first row.

`ResultSet` also declares various methods for returning the current row's column values based on their types. For example, `int getInt(String columnName)` returns the integer value corresponding to the `INTEGER`-based column identified by `columnName`.

A prepared statement represents a precompiled SQL statement. The SQL statement is compiled to improve performance and prevent SQL injection, and the compiled result is stored in a `PreparedStatement` implementation instance.

A callable statement is a special kind of prepared statement for executing SQL stored procedures in which a stored procedure is a list of SQL statements that perform a specific task. The argument passed to a callable statement's `prepareCall()` method is specified using escape syntax.

A data source is typically associated with metadata that describes the data source. When the data source is an RDBMS, this data is typically stored in a collection of tables. Metadata includes a list of catalogs, base tables, views, indexes, schemas, and additional information.

Databases can store XML documents, which are a convenient way to exchange data. Chapter 15 introduces you to XML and shows you how to parse, create, and transform XML documents.

# Parsing, Creating, and Transforming XML Documents

Applications commonly use XML documents to store and exchange data. In Chapter 15, I introduce XML for the benefit of those who are unfamiliar with this technology.

Java supports XML via the SAX, DOM, StAX, XPath, and XSLT APIs. After introducing XML, I also introduce these APIs, except for StAX, which Android doesn't support. Instead of StAX, I introduce Android's XMLPULL V1 API, which is somewhat equivalent to StAX.

## What Is XML?

XML (eXtensible Markup Language) is a *metalanguage* (a language used to describe other languages) for defining *vocabularies* (custom markup languages), which is key to XML's importance and popularity. XML-based vocabularies (such as XHTML) let you describe documents in a meaningful way.

XML vocabulary documents are like HTML (see <http://en.wikipedia.org/wiki/HTML>) documents in that they are text-based and consist of *markup* (encoded descriptions of a document's logical structure) and *content* (document text not interpreted as markup). Markup is evidenced via *tags* (angle bracket-delimited syntactic constructs) and each tag has a name. Furthermore, some tags have *attributes* (name-value pairs).



**Note** XML and HTML are descendants of *Standard Generalized Markup Language (SGML)*, which is the original metalanguage for creating vocabularies. XML is essentially a restricted form of SGML, while HTML is an *application* of SGML. The key difference between XML and HTML is that XML invites you to create your own vocabularies with their own tags and rules, whereas HTML gives you a single precreated vocabulary with its own fixed set of tags and rules. XHTML and other XML-based vocabularies are *XML applications*. XHTML was created to be a cleaner implementation of HTML.

If you haven't previously encountered XML, you might be surprised by its simplicity and how closely its vocabularies resemble HTML. You don't need to be a rocket scientist to learn how to create an XML document. To prove this to yourself, check out Listing 15-1.

*Listing 15-1. XML-Based Recipe for a Grilled Cheese Sandwich*

```
<recipe>
  <title>
    Grilled Cheese Sandwich
  </title>
  <ingredients>
    <ingredient qty="2">
      bread slice
    </ingredient>
    <ingredient>
      cheese slice
    </ingredient>
    <ingredient qty="2">
      margarine pat
    </ingredient>
  </ingredients>
  <instructions>
    Place frying pan on element and select medium heat. For each bread slice, smear
    one pat of margarine on one side of bread slice. Place cheese slice between bread
    slices with margarine-smearred sides away from the cheese. Place sandwich in frying
    pan with one margarine-smearred side in contact with pan. Fry for a couple of
    minutes and flip. Fry other side for a minute and serve.
  </instructions>
</recipe>
```

Listing 15-1 presents an XML document that describes a recipe for making a grilled cheese sandwich. This document is reminiscent of an HTML document in that it consists of tags, attributes, and content. However, that's where the similarity ends. Instead of presenting HTML tags such as `<html>`, `<head>`, `<img>`, and `<p>`, this informal recipe language presents its own `<recipe>`, `<ingredients>`, and other tags.

**Note** Although Listing 15-1's `<title>` and `</title>` tags are also found in HTML, they differ from their HTML counterparts. Web browsers typically display the content between these tags in their title bars. In contrast, the content between Listing 15-1's `<title>` and `</title>` tags might be displayed as a header, spoken aloud, or presented in some other way, depending on the application that parses this document.

XML documents are based on the XML declaration, elements and attributes, character references and CDATA sections, namespaces, and comments and processing instructions. After learning about these fundamentals, you'll learn what it means for an XML document to be well formed. You will also learn what it means for an XML document to be valid.

## XML Declaration

An XML document will typically begin with the *XML declaration*, special markup that informs an XML parser that the document is XML. The absence of the XML declaration in Listing 15-1 reveals that this special markup isn't mandatory. When the XML declaration is present, nothing can appear before it.

The XML declaration minimally looks like `<?xml version="1.0"?>` in which the nonoptional `version` attribute identifies the version of the XML specification to which the document conforms. The initial version of this specification (1.0) was introduced in 1998 and is widely implemented.

**Note** The World Wide Web Consortium (W3C), which maintains XML, released version 1.1 in 2004. This version mainly supports the use of line-ending characters used on EBCDIC platforms (see <http://en.wikipedia.org/wiki/EBCDIC>) and the use of scripts and characters that are absent from Unicode 3.2 (see <http://en.wikipedia.org/wiki/Unicode>). Unlike XML 1.0, XML 1.1 isn't widely implemented and should be used only by those needing its unique features.

XML supports Unicode, which means that XML documents consist entirely of characters taken from the Unicode character set. The document's characters are encoded into bytes for storage or transmission, and the encoding is specified via the XML declaration's optional encoding attribute. One common encoding is *UTF-8* (see <http://en.wikipedia.org/wiki/UTF-8>), which is a variable-length encoding of the Unicode character set. UTF-8 is a strict superset of ASCII (see <http://en.wikipedia.org/wiki/Ascii>), which means that pure ASCII text files are also UTF-8 documents.

**Note** In the absence of the XML declaration or when the XML declaration's encoding attribute isn't present, an XML parser typically looks for a special character sequence at the start of a document to determine the document's encoding. This character sequence is known as the *byte-order-mark (BOM)* and is created by an editor program (such as Microsoft Windows Notepad) when it saves the document according to UTF-8 or some other encoding. For example, the hexadecimal sequence EF BB BF signifies UTF-8 as the encoding. Similarly, FE FF signifies UTF-16 big endian (see <http://en.wikipedia.org/wiki/UTF-16/UCS-2>), FF FE signifies UTF-16 little endian, 00 00 FE FF signifies UTF-32 big endian (see <http://en.wikipedia.org/wiki/UTF-32/UCS-4>), and FF FE 00 00 signifies UTF-32 little endian. UTF-8 is assumed when no BOM is present.

If you'll never use characters apart from the ASCII character set, you can probably forget about the encoding attribute. However, when your native language isn't English or when you're called to create XML documents that include non-ASCII characters, you need to specify encoding properly. For example, when your document contains ASCII plus characters from a non-English Western European Language (such as ç, the cedilla used in French, Portuguese, and other languages), you might want to choose ISO-8859-1 as the encoding attribute's value; the document will probably have a smaller size when encoded in this manner than when encoded with UTF-8. Listing 15-2 shows you the resulting XML declaration.

*Listing 15-2. An Encoded Document Containing Non-ASCII Characters*

```
<?xml version="1.0" encoding="ISO-8859-1"?>
<movie>
  <name>Le Fabuleux Destin d'Amélie Poulain</name>
  <language>français</language>
</movie>
```

The final attribute that can appear in the XML declaration is `standalone`. This optional attribute determines whether the XML document relies on an external DTD (discussed later in this chapter) or not: its value is `no` when relying on an external DTD, or `yes` when not relying on an external DTD. The value defaults to `no`, implying that there is an external DTD. However, because there's no guarantee of a DTD, `standalone` is rarely used and won't be discussed further.

## Elements and Attributes

Following the XML declaration is a *hierarchical* (tree) structure of elements, where an *element* is a portion of the document delimited by a *start tag* (such as `<name>`) and an *end tag* (such as `</name>`), or is an *empty-element tag* (a standalone tag whose name ends with a forward slash [`/`], such as `<break/>`). Start tags and end tags surround content and possibly other markup whereas empty-element tags don't surround anything. Figure 15-1 reveals Listing 15-1's XML document tree structure.

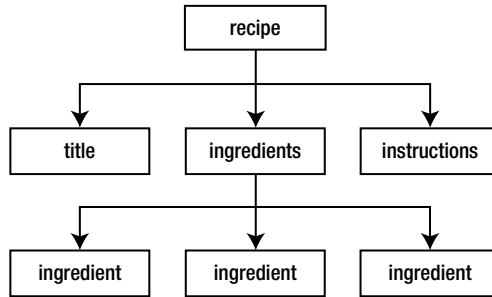

**Figure 15-1.** Listing 15-1's tree structure is rooted in the *recipe* element

As with HTML document structure, the structure of an XML document is anchored in a *root element* (the topmost element). In HTML, the root element is `html` (the `<html>` and `</html>` tag pair). Unlike in HTML, you can choose the root element for your XML documents. Figure 15-1 shows the root element to be `recipe`.

Unlike the other elements that have parent elements, `recipe` has no parent. Also, `recipe` and `ingredients` have child elements: `recipe`'s children are `title`, `ingredients`, and `instructions`; and `ingredients`' children are three instances of `ingredient`. The `title`, `instructions`, and `ingredient` elements don't have child elements.

Elements can contain child elements, content, or *mixed content* (a combination of child elements and content). Listing 15-2 reveals that the `movie` element contains `name` and `language` child elements, and it also reveals that each of these child elements contains content (`language` contains `français`, for example). Listing 15-3 presents another example that demonstrates mixed content along with child elements and content.

**Listing 15-3. An abstract Element Containing Mixed Content**

```

<?xml version="1.0"?>
<article title="The Rebirth of JavaFX" lang="en">
  <abstract>
    JavaFX 2.0 marks a significant milestone in the history of JavaFX. Now that
    Sun Microsystems has passed the torch to Oracle, we have seen the demise of
    JavaFX Script and the emerge of Java APIs (such as
    <code-inline>javafx.application.Application</code-inline>) for interacting
    with this technology. This article introduces you to this new flavor of
    JavaFX, where you learn about JavaFX 2.0 architecture and key APIs.
  </abstract>
  <body>
  </body>
</article>
  
```

This document's root element is `article`, which contains `abstract` and `body` child elements. The `abstract` element mixes content with a `code-inline` element, which contains content. In contrast, the `body` element is empty.

**Note** As with Listings 15-1 and 15-2, Listing 15-3 also contains *whitespace* (invisible characters such as spaces, tabs, carriage returns, and line feeds). The XML specification permits whitespace to be added to a document. Whitespace appearing within content (such as spaces between words) is considered part of the content. In contrast, the parser typically ignores whitespace appearing between an end tag and the next start tag. Such whitespace isn't considered part of the content.

An XML element's start tag can contain one or more attributes. For example, Listing 15-1's `<ingredient>` tag has a `qty` (quantity) attribute and Listing 15-3's `<article>` tag has `title` and `lang` attributes. Attributes provide additional information about elements. For example, `qty` identifies the amount of an ingredient that can be added, `title` identifies an article's title, and `lang` identifies the language in which the article is written (en for English). Attributes can be optional. For example, when `qty` isn't specified, a default value of 1 is assumed.

**Note** Element and attribute names may contain any alphanumeric character from English or another language, and they may also include the underscore (`_`), hyphen (`-`), period (`.`), and colon (`:`) punctuation characters. The colon should only be used with namespaces (discussed later in this chapter), and names cannot contain whitespace.

## Character References and CDATA Sections

Certain characters cannot appear literally in the content that appears between a start tag and an end tag, or within an attribute value. For example, you cannot place a literal `<` character between a start tag and an end tag because doing so would confuse an XML parser into thinking that it had encountered another tag.

One solution to this problem is to replace the literal character with a *character reference*, which is a code that represents the character. Character references are classified as numeric character references or character entity references.

- A *numeric character reference* refers to a character via its Unicode code point and adheres to the format `&#nnnn;` (not restricted to four positions) or `&#xhhhh;` (not restricted to four positions), where `nnnn` provides a decimal representation of the code point and `hhhh` provides a hexadecimal representation. For example, `&#0931;` and `&#x03A3;` represent the Greek capital letter sigma. Although XML mandates that the `x` in `&#xhhhh;` be lowercase, it's flexible in that the leading zero is optional in either format and in allowing you to specify an uppercase or lowercase letter for each `h`. As a result, `&#931;`, `&#x3A3;`, and `&#x03a3;` are also valid representations of the Greek capital letter sigma.

- A *character entity reference* refers to a character via the name of an *entity* (aliased data) that specifies the desired character as its replacement text. Character entity references are predefined by XML and have the format `&name;`, in which *name* is the entity's name. XML predefines five character entity references: `&lt;` (<), `&gt;` (>), `&amp;` (&), `&apos;` ('), and `&quot;` (").

Consider `<expression>6 < 4</expression>`. You could replace the `<` with numeric reference `&#60;`, yielding `<expression>6 &#60; 4</expression>`, or better yet with `&lt;`, yielding `<expression>6 &lt; 4</expression>`. The second choice is clearer and easier to remember.

Suppose you want to embed an HTML or XML document within an element. To make the embedded document acceptable to an XML parser, you would need to replace each literal `<` (start of tag) and `&` (start of entity) character with its `&lt;` and `&amp;` predefined character entity reference, a tedious and possibly error prone undertaking since you might forget to replace one of these characters. To save you from tedium and potential errors, XML provides an alternative in the form of a CDATA (character data) section.

A *CDATA section* is a section of literal HTML or XML markup and content surrounded by the `<![CDATA[ prefix and the ]]>` suffix. You don't need to specify predefined character entity references within a CDATA section, as demonstrated in Listing 15-4.

*Listing 15-4. Embedding an XML Document in Another Document's CDATA Section*

```
<?xml version="1.0"?>
<svg-examples>
  <example>
    The following Scalable Vector Graphics document describes a blue-filled and
    black-stroked rectangle.
    <![CDATA[<svg width="100%" height="100%" version="1.1"
      xmlns="http://www.w3.org/2000/svg">
        <rect width="300" height="100"
          style="fill:rgb(0,0,255);stroke-width:1; stroke:rgb(0,0,0)"/>
        </svg>]]>
  </example>
</svg-examples>
```

Listing 15-4 embeds a Scalable Vector Graphics (SVG) [see <http://en.wikipedia.org/wiki/Svg>] XML document within the `example` element of an SVG `examples` document. The SVG document is placed in a CDATA section, obviating the need to replace all `<` characters with `&lt;`; predefined character entity references.

## Namespaces

It's common to create XML documents that combine features from different XML languages. Namespaces are used to prevent name conflicts when elements and other XML language features appear. Without namespaces, an XML parser couldn't distinguish between same-named elements or other language features that mean different things, such as two same-named `title` elements from two different languages.

**Note** Namespaces aren't part of XML 1.0. They arrived about a year after this specification was released. To ensure backward compatibility with XML 1.0, namespaces take advantage of colon characters, which are legal characters in XML names. Parsers that don't recognize namespaces return names that include colons.

A *namespace* is a Uniform Resource Identifier (URI)-based container that helps differentiate XML vocabularies by providing a unique context for its contained identifiers. The namespace URI is associated with a *namespace prefix* (an alias for the URI) by specifying, typically on an XML document's root element, either the `xmlns` attribute by itself (which signifies the default namespace) or the `xmlns:prefix` attribute (which signifies the namespace identified as *prefix*), and assigning the URI to this attribute.

**Note** A namespace's scope starts at the element where it's declared and is applied to all of the element's content unless overridden by another namespace declaration with the same prefix name.

When *prefix* is specified, it and a colon character are prepended to the name of each element tag that belongs to that namespace (see Listing 15-5).

*Listing 15-5. Introducing a Pair of Namespaces*

```
<?xml version="1.0"?>
<h:html xmlns:h="http://www.w3.org/1999/xhtml"
  xmlns:r="http://www.tutortutor.ca/">
  <h:head>
    <h:title>
      Recipe
    </h:title>
  </h:head>
  <h:body>
    <r:recipe>
      <r:title>
        Grilled Cheese Sandwich
      </r:title>
      <r:ingredients>
        <h:ul>
          <h:li>
            <r:ingredient qty="2">
              bread slice
            </r:ingredient>
          </h:li>
          <h:li>
            <r:ingredient>
              cheese slice
            </r:ingredient>
          </h:li>
        </h:ul>
      </r:ingredients>
    </r:recipe>
  </h:body>
</h:html>
```

```

<h:li>
<r:ingredient qty="2">
  margarine pat
</r:ingredient>
</h:li>
</h:ul>
</r:ingredients>
<h:p>
<r:instructions>
  Place frying pan on element and select medium heat. For each bread slice, smear
  one pat of margarine on one side of bread slice. Place cheese slice between
  bread slices with margarine-smearred sides away from the cheese. Place sandwich
  in frying pan with one margarine-smearred side in contact with pan. Fry for a
  couple of minutes and flip. Fry other side for a minute and serve.
</r:instructions>
</h:p>
</r:recipe>
</h:body>
</h:html>

```

Listing 15-5 describes a document that combines elements from the XHTML language (see <http://en.wikipedia.org/wiki/XHTML>) with elements from the recipe language. All element tags that associate with XHTML are prefixed with `h:`, and all element tags that associate with the recipe language are prefixed with `r:`.

The `h:` prefix associates with the [www.w3.org/1999/xhtml](http://www.w3.org/1999/xhtml) URI, and the `r:` prefix associates with the [www.tutortutor.ca](http://www.tutortutor.ca) URI. XML doesn't mandate that URIs point to document files. It only requires that they be unique to guarantee unique namespaces.

This document's separation of the recipe data from the XHTML elements makes it possible to preserve this data's structure while also allowing an XHTML-compliant web browser (such as Google Chrome) to present the recipe via a web page (see Figure 15-2).

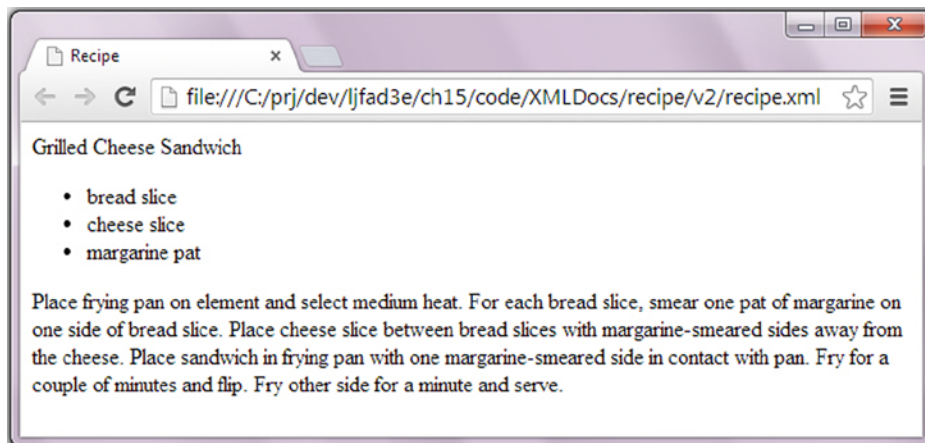

Figure 15-2. Google Chrome presents the recipe data via XHTML tags



A tag's attributes don't need to be prefixed when those attributes belong to the element. For example, `qty` isn't prefixed in `<r:ingredient qty="2">`. However, a prefix is required for attributes belonging to other namespaces. For example, suppose you want to add an XHTML `style` attribute to the document's `<r:title>` tag to provide styling for the recipe title when displayed via an application. You can accomplish this task by inserting an XHTML attribute into the `title` tag, as follows:

```
<r:title h:style="font-family: sans-serif;">
```

The XHTML `style` attribute has been prefixed with `h:` because this attribute belongs to the XHTML language namespace and not to the recipe language namespace.

When multiple namespaces are involved, it can be convenient to specify one of these namespaces as the default namespace to reduce the tedium in entering namespace prefixes. Consider Listing 15-6.

*Listing 15-6. Specifying a Default Namespace*

```
<?xml version="1.0"?>
<html xmlns="http://www.w3.org/1999/xhtml"
      xmlns:r="http://www.tutortutor.ca/">
  <head>
    <title>
      Recipe
    </title>
  </head>
  <body>
    <r:recipe>
      <r:title>
        Grilled Cheese Sandwich
      </r:title>
      <r:ingredients>
        <ul>
          <li>
            <r:ingredient qty="2">
              bread slice
            </r:ingredient>
          </li>
          <li>
            <r:ingredient>
              cheese slice
            </r:ingredient>
          </li>
          <li>
            <r:ingredient qty="2">
              margarine pat
            </r:ingredient>
          </li>
        </ul>
      </r:ingredients>
      <p>
        <r:instructions>
```

```

    Place frying pan on element and select medium heat. For each bread slice, smear
    one pat of margarine on one side of bread slice. Place cheese slice between
    bread slices with margarine-smearred sides away from the cheese. Place sandwich
    in frying pan with one margarine-smearred side in contact with pan. Fry for a
    couple of minutes and flip. Fry other side for a minute and serve.
  </r:instructions>
</p>
</r:recipe>
</body>
</html>

```

Listing 15-6 specifies a default namespace for the XHTML language. No XHTML element tag needs to be prefixed with `h:`. However, recipe language element tags must still be prefixed with the `r:` prefix.

## Comment and Processing Instructions

XML documents can contain *comments*, which are character sequences beginning with `<!--` and ending with `-->`. For example, you might place `<!-- Todo -->` in Listing 15-3's body element to remind yourself that you need to finish coding this element.

Comments are used to clarify portions of a document. They can appear anywhere after the XML declaration except within tags; they cannot be nested, cannot contain a double hyphen (`--`) because doing so might confuse an XML parser that the comment has been closed, shouldn't contain a hyphen (`-`) for the same reason, and they are typically ignored during processing. Comments are not content.

XML also permits processing instructions to be present. A *processing instruction* is an instruction that's made available to the application parsing the document. The instruction begins with `<?` and ends with `?>`. The `<?` prefix is followed by a name known as the *target*. This name typically identifies the application to which the processing instruction is intended. The rest of the processing instruction contains text in a format appropriate to the application. Two examples of processing instructions are `<?xml-stylesheet href="modern.xml" type="text/xml"?>` (associate an eXtensible Stylesheet Language [XSL] style sheet [see <http://en.wikipedia.org/wiki/XSL>] with an XML document) and `<?php /* PHP code */ ?>` (pass a PHP [see <http://en.wikipedia.org/wiki/Php>] code fragment to the application). Although the XML declaration looks like a processing instruction, this isn't the case.

**Note** The XML declaration isn't a processing instruction.

## Well-Formed Documents

HTML is a sloppy language in which elements can be specified out of order, end tags can be omitted, and so on. The complexity of a web browser's page layout code is partly due to the need to handle these special cases. In contrast, XML is a much stricter language. To make XML documents easier to parse, XML mandates that XML documents follow certain rules:

- *All elements must either have start and end tags or consist of empty-element tags.* For example, unlike the HTML `<p>` tag that's often specified without a `</p>` counterpart, `</p>` must also be present from an XML document perspective.
- *Tags must be nested correctly.* For example, while you'll probably get away with specifying `<b><i>Android</b></i>` in HTML, an XML parser would report an error. In contrast, `<b><i>Android</i></b>` doesn't result in an error.
- *All attribute values must be quoted.* Either single quotes (') or double quotes (") are permissible (although double quotes are the more commonly specified quotes). It's an error to omit these quotes.
- *Empty elements must be properly formatted.* For example, HTML's `<br>` tag would have to be specified as `<br />` in XML. You can specify a space between the tag's name and the / character, although the space is optional.
- *Be careful with case.* XML is a case-sensitive language in which tags differing in case (such as `<author>` and `<Author>`) are considered different. It's an error to mix start and end tags of different cases, for example, `<author>` with `</Author>`.

XML parsers that are aware of namespaces enforce two additional rules:

- All element and attribute names must not include more than one colon character.
- No entity names, processing instruction targets, or notation names (discussed later) can contain colons.

An XML document that conforms to these rules is *well formed*. The document has a logical and clean appearance and is much easier to process. XML parsers will only parse well-formed XML documents.

## Valid Documents

It's not always enough for an XML document to be well formed; in many cases, the document must also be valid. A *valid* document adheres to constraints. For example, a constraint could be placed upon Listing 15-1's recipe document to ensure that the `ingredients` element always precedes the `instructions` element; perhaps an application must first process ingredients.

**Note** XML document validation is similar to a compiler analyzing source code to make sure that the code makes sense in a machine context. For example, each of `int`, `count`, `=`, `1`, and `;` are valid Java character sequences but `1 count ; int =` isn't a valid Java construct (whereas `int count = 1;` is a valid Java construct).

Some XML parsers perform validation, whereas other parsers don't because validating parsers are harder to write. A parser that performs validation compares an XML document to a grammar document. Any deviation from this document is reported as an error to the application; the document isn't valid. The application may choose to fix the error or reject the document. Unlike well-formedness errors, validity errors aren't necessarily fatal and the parser can continue to parse the document.

**Note** Validating XML parsers often don't validate by default because validation can be time-consuming. They must be instructed to perform validation.

Grammar documents are written in a special language. Two commonly-used grammar languages are Document Type Definition and XML Schema.

## Document Type Definition

*Document Type Definition (DTD)* is the oldest grammar language for specifying an XML document's grammar. DTD grammar documents (known as DTDs) are written in accordance with a strict syntax that states what elements may be present and in what parts of a document. It also states what is contained within elements (child elements, content, or mixed content) and what attributes may be specified. For example, a DTD may specify that a recipe element must have an ingredients element followed by an instructions element.

Listing 15-7 presents a DTD for the recipe language that was used to construct Listing 15-1's document.

### *Listing 15-7. The Recipe Language's DTD*

```
<!ELEMENT recipe (title, ingredients, instructions)>
<!ELEMENT title (#PCDATA)>
<!ELEMENT ingredients (ingredient+)>
<!ELEMENT ingredient (#PCDATA)>
<!ELEMENT instructions (#PCDATA)>
<!ATTLIST ingredient qty CDATA "1">
```

This DTD first declares the recipe language's elements. Element declarations take the form `<!ELEMENT name content-specifier>`, where *name* is any legal XML name (it cannot contain whitespace, for example), and *content-specifier* identifies what can appear within the element.

The first element declaration states that exactly one recipe element can appear in the XML document; this declaration doesn't imply that recipe is the root element. Furthermore, this element must include exactly one each of the title, ingredients, and instructions child elements, and in that order. Child elements must be specified as a comma-separated list. Furthermore, a list is always surrounded by parentheses.

The second element declaration states that the title element contains *parsed character data* (nonmarkup text). The third element declaration states that at least one ingredient element must appear in ingredients. The + character is an example of a regular expression that means one or more. Other expressions that may be used are \* (zero or more) and ? (once or not at all). The fourth and fifth element declarations are similar to the second by stating that ingredient and instructions elements contain parsed character data.

**Note** Element declarations support three other content specifiers. You can specify `<!ELEMENT name ANY>` to allow any type of element content or `<!ELEMENT name EMPTY>` to disallow any element content. To state that an element contains mixed content, you would specify `#PCDATA` and a list of element names, separated by vertical bars (`|`). For example, `<!ELEMENT ingredient (#PCDATA | measure | note)*>` states that the `ingredient` element can contain a mix of parsed character data, zero or more `measure` elements, and zero or more `note` elements. It doesn't specify the order in which the parsed character data and these elements occur. However, `#PCDATA` must be the first item specified in the list. When a regular expression is used in this context, it must appear to the right of the closing parenthesis.

Listing 15-7's DTD lastly declares the recipe language's attributes, of which there is only one: `qty`. Attribute declarations take the form `<!ATTLIST ename aname type default-value>`, where *ename* is the name of the element to which the attribute belongs, *aname* is the name of the attribute, *type* is the attribute's type, and *default-value* is the attribute's default value.

The attribute declaration identifies `qty` as an attribute of `ingredient`. It also states that `qty`'s type is `CDATA` (any string of characters not including the ampersand, less than or greater than signs, or double quotes may appear; these characters may be represented via `&amp;`, `&lt;`, `&gt;`, or `&quot;`, respectively), and that `qty` is optional, assuming default value 1 when not present.

## MORE ABOUT ATTRIBUTES

DTD lets you specify additional attribute types: `ID` (create a unique identifier for an attribute that identifies an element), `IDREF` (an attribute's value is an element located elsewhere in the document), `IDREFS` (the value consists of multiple `IDREFs`), `ENTITY` (you can use external binary data or unparsed entities), `ENTITIES` (the value consists of multiple entities), `NMTOKEN` (the value is restricted to any valid XML name), `NMTOKENS` (the value is composed of multiple XML names), `NOTATION` (the value is already specified via a DTD notation declaration), and `enumerated` (a list of possible values from which to choose; values are separated with vertical bars).

Instead of specifying a default value verbatim, you can specify `#REQUIRED` to mean that the attribute must always be present with some value (`<!ATTLIST ename aname type #REQUIRED>`), `#IMPLIED` to mean that the attribute is optional and no default value is provided (`<!ATTLIST ename aname type #IMPLIED>`), or `#FIXED` to mean that the attribute is optional and must always take on the DTD-assigned default value when used (`<!ATTLIST ename aname type #FIXED "value">`).

You can specify a list of attributes in one `ATTLIST` declaration. For example, `<!ATTLIST ename aname1 type1 default-value1 aname2 type2 default-value2>` declares two attributes identified as *aname1* and *aname2*.

A DTD-based validating XML parser requires that a document include a *document type declaration* identifying the DTD that specifies the document's grammar before it will validate the document.

**Note** Document Type Definition and document type declaration are two different things. The DTD acronym identifies a Document Type Definition and never identifies a document type declaration.

A document type declaration appears immediately after the XML declaration, and it is specified in one of the following ways:

- `<!DOCTYPE root-element-name SYSTEM uri>` references an external but private DTD via *uri*. The referenced DTD isn't available for public scrutiny. For example, I might store my recipe language's DTD file (`recipe.dtd`) in a private `dtds` directory on my [www.tutortutor.ca](http://www.tutortutor.ca) website and use `<!DOCTYPE recipe SYSTEM "http://www.tutortutor.ca/dtds/recipe.dtd">` to identify this DTD's location via *system identifier* `http://www.tutortutor.ca/dtds/recipe.dtd`.
- `<!DOCTYPE root-element-name PUBLIC fpi uri>` references an external but public DTD via *fpi*, a *formal public identifier* (see [http://en.wikipedia.org/wiki/Formal\\_Public\\_Identifier](http://en.wikipedia.org/wiki/Formal_Public_Identifier)), and *uri*. If a validating XML parser cannot locate the DTD via public identifier *fpi*, it can use system identifier *uri* to locate the DTD. For example, `<!DOCTYPE html PUBLIC "-//W3C//DTD XHTML 1.0 Transitional//EN" "http://www.w3.org/TR/xhtml1/DTD/xhtml1-transitional.dtd">` references the XHTML 1.0 DTD first via public identifier `-//W3C//DTD XHTML 1.0 Transitional//EN` and second via system identifier <http://www.w3.org/TR/xhtml1/DTD/xhtml1-transitional.dtd>.
- `<!DOCTYPE root-element [ dtd ]>` references an internal DTD, one that is embedded within the XML document. The internal DTD must appear between square brackets.

Listing 15-8 presents Listing 15-1 (minus the child elements between the `<recipe>` and `</recipe>` tags) with an internal DTD.

*Listing 15-8. The Recipe Document with an Internal DTD*

```
<?xml version="1.0"?>
<!DOCTYPE recipe [
  <!ELEMENT recipe (title, ingredients, instructions)>
  <!ELEMENT title (#PCDATA)>
  <!ELEMENT ingredients (ingredient+)>
  <!ELEMENT ingredient (#PCDATA)>
  <!ELEMENT instructions (#PCDATA)>
  <!ATTLIST ingredient qty CDATA "1">
]>
<recipe>
  <!-- Child elements removed for brevity. -->
</recipe>
```

**Note** A document can have internal and external DTDs; for example, `<!DOCTYPE recipe SYSTEM "http://www.tutortutor.ca/dtds/recipe.dtd" [ <!ELEMENT ...>]>`. The internal DTD is referred to as the *internal DTD subset* and the external DTD is referred to as the *external DTD subset*. Neither subset can override the element declarations of the other subset.

You can also declare notations and general and parameter entities within DTDs. A *notation* is an arbitrary piece of data that typically describes the format of unparsed binary data, and it typically has the form `<!NOTATION name SYSTEM uri>`, where *name* identifies the notation and *uri* identifies some kind of plug-in that can process the data on behalf of the application that's parsing the XML document. For example, `<!NOTATION image SYSTEM "psp.exe">` declares a notation named `image` and identifies Windows executable `psp.exe` as a plug-in for processing images.

It's also common to use notations to specify binary data types via Internet media types (see [http://en.wikipedia.org/wiki/Internet\\_media\\_type](http://en.wikipedia.org/wiki/Internet_media_type)). For example, `<!NOTATION image SYSTEM "image/jpeg">` declares an image notation that identifies the `image/jpeg` Internet media type for Joint Photographic Experts Group images.

*General entities* are entities referenced from inside an XML document via *general entity references*—syntactic constructs of the form `&name;`. Examples include the predefined `lt`, `gt`, `amp`, `apos`, and `quot` character entities whose `&lt;`, `&gt;`, `&amp;`, `&apos;`, and `&quot;` character entity references are aliases for characters `<`, `>`, `&`, `'`, and `"`, respectively.

General entities are classified as internal or external. An *internal general entity* is a general entity whose value is stored in the DTD and has the form `<!ENTITY name value>`, where *name* identifies the entity and *value* specifies its value. For example, `<!ENTITY copyright "Copyright &copy; 2014 Jeff Friesen. All rights reserved.">` declares an internal general entity named `copyright`. The value of this entity may include another declared entity, such as `&copy;` (the HTML entity for the copyright symbol), and can be referenced from anywhere in an XML document by specifying `&copyright;`.

An *external general entity* is a general entity whose value is stored outside the DTD. The value might be textual data (such as an XML document) or it might be binary data (such as a JPEG image). External general entities are classified as external parsed general entities and external unparsed entities.

An *external parsed general entity* references an external file that stores the entity's textual data, which is subject to being inserted into a document and parsed by a validating parser when a general entity reference is specified in the document and that has the form `<!ENTITY name SYSTEM uri>`, where *name* identifies the entity and *uri* identifies the external file. For example, `<!ENTITY chapter-header SYSTEM "http://www.tutortutor.ca/entities/chapheader.xml">` identifies `chapheader.xml` as storing the XML content to be inserted into an XML document wherever `&chapter-header;` appears in the document. The alternative `<!ENTITY name PUBLIC fpi uri>` form can be specified.

**Caution** Because the contents of an external file may be parsed, this content must be well formed.

An *external unparsed entity* references an external file that stores the entity's binary data and has the form `<!ENTITY name SYSTEM uri NDATA nname>`, where *name* identifies the entity, *uri* locates the external file, and NDATA identifies the notation declaration named *nname*. The notation typically identifies a plug-in for processing the binary data or the Internet media type of this data. For example, `<!ENTITY photo SYSTEM "photo.jpg" NDATA image>` associates name *photo* with external binary file *photo.png* and notation *image*. The alternative `<!ENTITY name PUBLIC fpi uri NDATA nname>` form can be specified.

**Note** XML doesn't allow references to external general entities to appear in attribute values. For example, you cannot specify `&chapter-header;` in an attribute's value.

*Parameter entities* are entities referenced from inside a DTD via *parameter entity references*, syntactic constructs of the form `%name;`. They're useful for eliminating repetitive content from element declarations. For example, you're creating a DTD for a large company, and this DTD contains three element declarations: `<!ELEMENT salesperson (firstname, lastname)>`, `<!ELEMENT lawyer (firstname, lastname)>`, and `<!ELEMENT accountant (firstname, lastname)>`. Each element contains repeated child element content. If you need to add another child element (such as *middleinitial*), you'll need to make sure that all of the elements are updated; otherwise, you risk a malformed DTD. Parameter entities can help you solve this problem.

Parameter entities are classified as internal or external. An *internal parameter entity* is a parameter entity whose value is stored in the DTD and has the form `<!ENTITY % name value>`, where *name* identifies the entity and *value* specifies its value. For example, `<!ENTITY % person-name "firstname, lastname">` declares a parameter entity named *person-name* with value *firstname, lastname*. Once declared, this entity can be referenced in the three previous element declarations as follows: `<!ELEMENT salesperson (%person-name;)>`, `<!ELEMENT lawyer (%person-name;)>`, and `<!ELEMENT accountant (%person-name;)>`. Instead of adding *middleinitial* to each of *salesperson*, *lawyer*, and *accountant*, as was done previously, you would now add this child element to *person-name*, as in `<!ENTITY % person-name "firstname, middleinitial, lastname">`, and this change would be applied to these element declarations.

An *external parameter entity* is a parameter entity whose value is stored outside the DTD. It has the form `<!ENTITY % name SYSTEM uri>`, where *name* identifies the entity and *uri* locates the external file. For example, `<!ENTITY % person-name SYSTEM "http://www.tutortutor.ca/entities/names.dtd">` identifies *names.dtd* as storing the *firstname, lastname* text to be inserted into a DTD wherever `%person-name;` appears in the DTD. The alternative `<!ENTITY % name PUBLIC fpi uri>` form can be specified.

**Note** This discussion sums up the basics of DTD. One additional topic that wasn't covered (for brevity) is *conditional inclusion*, which lets you specify those portions of a DTD to make available to parsers and is typically used with parameter entity references.



## XML Schema

*XML Schema* is a grammar language for declaring the structure, content, and *semantics* (meaning) of an XML document. This language's grammar documents are known as *schemas* that are themselves XML documents. Schemas must conform to the XML Schema DTD (see [www.w3.org/2001/XMLSchema.dtd](http://www.w3.org/2001/XMLSchema.dtd)).

XML Schema was introduced by the W3C to overcome limitations with DTD, such as DTD's lack of support for namespaces. Also, XML Schema provides an object-oriented approach to declaring an XML document's grammar. This grammar language provides a much larger set of primitive types than DTD's CDATA and PCDATA types. For example, you'll find integer, floating-point, various date and time, and string types to be part of XML Schema.

**Note** XML Schema predefines 19 primitive types, which are expressed via the following identifiers: anyURI, base64Binary, boolean, date, dateTime, decimal, double, duration, float, hexBinary, gDay, gMonth, gMonthDay, gYear, gYearMonth, NOTATION, QName, string, and time.

XML Schema provides *restriction* (reducing the set of permitted values through constraints), *list* (allowing a sequence of values), and *union* (allowing a choice of values from several types) derivation methods for creating new *simple types* from these primitive types. For example, XML Schema derives 13 integer types from decimal through restriction; these types are expressed via the following identifiers: byte, int, integer, long, negativeInteger, nonNegativeInteger, nonPositiveInteger, positiveInteger, short, unsignedByte, unsignedInt, unsignedLong, and unsignedShort. It also provides support for creating *complex types* from simple types.

A good way to become familiar with XML Schema is to follow through an example, such as creating a schema for Listing 15-1's recipe language document. The first step in creating this recipe language schema is to identify all of its elements and attributes. The elements are recipe, title, ingredients, instructions, and ingredient; qty is the solitary attribute.

The next step is to classify the elements according to XML Schema's *content model*, which specifies the types of child elements and text *nodes* (see [http://en.wikipedia.org/wiki/Node\\_\(computer\\_science\)](http://en.wikipedia.org/wiki/Node_(computer_science))) that can be included in an element. An element is considered to be *empty* when the element has no child elements or text nodes, *simple* when only text nodes are accepted, *complex* when only child elements are accepted, and *mixed* when child elements and text nodes are accepted. None of Listing 15-1's elements have empty or mixed content models. However, the title, ingredient, and instructions elements have simple content models; and the recipe and ingredients elements have complex content models.

For elements that have a simple content model, you can distinguish between elements having attributes and elements not having attributes. XML Schema classifies elements having a simple content model and no attributes as simple types. Furthermore, it classifies elements having a simple content model and attributes, or elements from other content models as complex types. Furthermore, XML Schema classifies attributes as simple types because they only contain text values; attributes don't have child elements. Listing 15-1's title and instructions elements and its qty attribute are simple types. Its recipe, ingredients, and ingredient elements are complex types.

At this point, you can begin to declare the schema. The following example presents the introductory schema element:

```
<xs:schema xmlns:xs="http://www.w3.org/2001/XMLSchema">
```

The schema element introduces the grammar. It also assigns the commonly used `xs` namespace prefix to the standard XML Schema namespace; `xs:` is subsequently prepended to XML Schema element names.

Next you use the `element` element to declare the title and instructions simple type elements as follows:

```
<xs:element name="title" type="xs:string"/>
<xs:element name="instructions" type="xs:string"/>
```

XML Schema requires that each element have a name and (unlike DTD) be associated with a type, which identifies the kind of data stored in the element. For example, the first element declaration identifies `title` as the name via its `name` attribute and `string` as the type via its `type` attribute (string or character data appears between the `<title>` and `</title>` tags). The `xs:` prefix in `xs:string` is required because `string` is a predefined W3C type.

Continuing, you now use the `attribute` element to declare the `qty` simple type attribute, as follows:

```
<xs:attribute name="qty" type="xs:unsignedInt" default="1"/>
```

This attribute element declares an attribute named `qty`. I've chosen `unsignedInt` as this attribute's type because quantities are nonnegative values. Furthermore, I've specified `1` as the default value for when `qty` isn't specified—attribute elements default to declaring optional attributes.

**Note** The order of element and attribute declarations isn't significant within a schema.

Now that you've declared the simple types, you can start to declare the complex types. To begin, let's declare `recipe` as follows:

```
<xs:element name="recipe">
  <xs:complexType>
    <xs:sequence>
      <xs:element ref="title"/>
      <xs:element ref="ingredients"/>
      <xs:element ref="instructions"/>
    </xs:sequence>
  </xs:complexType>
</xs:element>
```

This declaration states that `recipe` is a complex type (via the `complexType` element) consisting of a sequence (via the `sequence` element) of one `title` element followed by one `ingredients` element followed by one `instructions` element. Each of these elements is declared by a different element that's referred to by its element's `ref` attribute.

The next complex type to declare is `ingredients`. The following example provides its declaration:

```
<xs:element name="ingredients">
  <xs:complexType>
    <xs:sequence>
      <xs:element ref="ingredient" maxOccurs="unbounded"/>
    </xs:sequence>
  </xs:complexType>
</xs:element>
```

This declaration states that `ingredients` is a complex type consisting of a sequence of one or more `ingredient` elements. The “or more” is specified by including `element`’s `maxOccurs` attribute and setting this attribute’s value to `unbounded`.

**Note** The `maxOccurs` attribute identifies the maximum number of times that an element can occur. A similar `minOccurs` attribute identifies the minimum number of times that an element can occur. Each attribute can be assigned 0 or a positive integer. Furthermore, you can specify `unbounded` for `maxOccurs`, which means that there’s no upper limit on occurrences of the element. Each attribute defaults to a value of 1, which means that an element can appear only one time when neither attribute is present.

The final complex type to declare is `ingredient`. Although `ingredient` can contain only text nodes, which implies that it should be a simple type, it’s the presence of the `qty` attribute that makes it complex. Check out the following declaration:

```
<xs:element name="ingredient">
  <xs:complexType>
    <xs:simpleContent>
      <xs:extension base="xs:string">
        <xs:attribute ref="qty"/>
      </xs:extension>
    </xs:simpleContent>
  </xs:complexType>
</xs:element>
```

The element named `ingredient` is a complex type (because of its optional `qty` attribute). The `simpleContent` element indicates that `ingredient` can only contain simple content (text nodes), and the `extension` element indicates that `ingredient` is a new type that extends the predefined `string` type (specified via the `base` attribute), implying that `ingredient` inherits all of `string`’s attributes and structure. Furthermore, `ingredient` is given an additional `qty` attribute.

Listing 15-9 combines the previous examples into a complete schema.

*Listing 15-9. The Recipe Document's Schema*

```

<?xml version="1.0"?>
<xs:schema xmlns:xs="http://www.w3.org/2001/XMLSchema">
<xs:element name="title" type="xs:string"/>
<xs:element name="instructions" type="xs:string"/>
<xs:attribute name="qty" type="xs:unsignedInt" default="1"/>
<xs:element name="recipe">
  <xs:complexType>
    <xs:sequence>
      <xs:element ref="title"/>
      <xs:element ref="ingredients"/>
      <xs:element ref="instructions"/>
    </xs:sequence>
  </xs:complexType>
</xs:element>
<xs:element name="ingredients">
  <xs:complexType>
    <xs:sequence>
      <xs:element ref="ingredient" maxOccurs="unbounded"/>
    </xs:sequence>
  </xs:complexType>
</xs:element>
<xs:element name="ingredient">
  <xs:complexType>
    <xs:simpleContent>
      <xs:extension base="xs:string">
        <xs:attribute ref="qty"/>
      </xs:extension>
    </xs:simpleContent>
  </xs:complexType>
</xs:element>

```

After creating the schema, you'll want to reference it from a recipe document. You can accomplish this task by specifying `xmlns:xsi` and `xsi:schemaLocation` attributes on the document's root element start tag (`<recipe>`) as follows:

```

<recipe xmlns="http://www.tutortutor.ca/"
  xmlns:xsi="http://www.w3.org/2001/XMLSchema-instance"
  xsi:schemaLocation="http://www.tutortutor.ca/schemas recipe.xsd">

```

The `xmlns` attribute identifies <http://www.tutortutor.ca/> as the document's default namespace. Unprefixed elements and their unprefixed attributes belong to this namespace.

The `xmlns:xsi` attribute associates the conventional `xsi` (XML Schema Instance) prefix with the standard <http://www.w3.org/2001/XMLSchema-instance> namespace. The only item in the document that's prefixed with `xsi:` is `schemaLocation`.

The `schemaLocation` attribute is used to locate the schema. This attribute's value can be multiple pairs of space-separated values, but it is specified as a single pair of such values in this example. The first value (<http://www.tutortutor.ca/schemas>) identifies the target namespace for the schema, and the second value (`recipe.xsd`) identifies the location of the schema within this namespace.

**Note** Schema files that conform to XML Schema's grammar are commonly assigned the `.xsd` file extension.

If an XML document declares a namespace (`xmlns` default or `xmlns:prefix`), that namespace must be made available to the schema so that a validating parser can resolve all references to elements and other schema components for that namespace. You also need to mention which namespace the schema describes, and you do so by including the `targetNamespace` attribute on the schema element. For example, suppose your recipe document declares a default XML namespace, as follows:

```
<?xml version="1.0"?>
<recipe xmlns="http://www.tutortutor.ca/">
```

At minimum, you would need to modify Listing 15-9's schema element to include `targetNamespace` and the recipe document's default namespace as `targetNamespace`'s value as follows:

```
<xs:schema targetNamespace="http://www.tutortutor.ca/"
  xmlns:xs="http://www.w3.org/2001/XMLSchema">
```

## Parsing XML Documents with SAX

*Simple API for XML (SAX)* is an event-based API for parsing an XML document sequentially from start to finish. As a SAX-oriented parser encounters an item from the document's *infoset* (an abstract data model describing an XML document's information, see [http://en.wikipedia.org/wiki/XML\\_Information\\_Set](http://en.wikipedia.org/wiki/XML_Information_Set)), it makes this item available to an application as an *event* by calling one of the methods in one of the application's *handlers* (an object whose methods are called by the parser to make event information available), which the application has previously registered with the parser. The application can then *consume* this event by processing the infoset item in some manner.

**Note** According to its official web site ([www.saxproject.org](http://www.saxproject.org)), SAX originated as an XML parsing API for Java. However, SAX isn't exclusive to Java. Microsoft also supports SAX for its .NET framework (see <http://saxdotnet.sourceforge.net>).

After taking you on a tour of the SAX API, I provide a simple demonstration of this API to help you become familiar with its event-based parsing paradigm. I then show you how to create a custom entity resolver.

## Exploring the SAX API

SAX exists in two major versions. Java implements SAX 1 through the `javax.xml.parsers` package's abstract `SAXParser` and `SAXParserFactory` classes, and it implements SAX 2 through the `org.xml.sax` package's `XMLReader` interface and through the `org.xml.sax.helpers` package's `XMLReaderFactory` class. The `org.xml.sax`, `org.xml.sax.ext`, and `org.xml.sax.helpers` packages provide various types that augment both Java implementations.

**Note** I explore only the SAX 2 implementation because SAX 2 makes available additional info set items about an XML document (such as comments and CDATA section notifications).

Classes that implement the `XMLReader` interface describe SAX 2-based parsers. Instances of these classes are obtained by calling the `XMLReaderFactory` class's `createXMLReader()` methods. For example, the following code fragment invokes this class's `XMLReader createXMLReader()` class method to create and return an `XMLReader` instance:

```
XMLReader xmlr = XMLReaderFactory.createXMLReader();
```

This method call returns an instance of an `XMLReader`-implementing class and assigns its reference to `xmlr`.

**Note** Behind the scenes, `createXMLReader()` attempts to create an `XMLReader` instance from system defaults according to a lookup procedure that first examines the `org.xml.sax.driver` system property to see if it has a value. If so, this property's value is used as the name of the class that implements `XMLReader`. Furthermore, an attempt to instantiate this class and return the instance is made. An instance of the `org.xml.sax.SAXException` class is thrown when `createXMLReader()` cannot obtain an appropriate class or instantiate the class.

The returned `XMLReader` object makes available several methods for configuring the parser and parsing a document's content. These methods are described below:

- `ContentHandler getContentHandler()` returns the current content handler, which is an instance of a class that implements the `org.xml.sax.ContentHandler` interface, or the null reference when none has been registered.
- `DTDHandler getDTDHandler()` returns the current DTD handler, which is an instance of a class that implements the `org.xml.sax.DTDHandler` interface, or the null reference when none has been registered.
- `EntityResolver getEntityResolver()` returns the current entity resolver, which is an instance of a class that implements the `org.xml.sax.EntityResolver` interface, or the null reference when none has been registered.

- `ErrorHandler errorHandler()` returns the current error handler, which is an instance of a class that implements the `org.xml.sax.ErrorHandler` interface, or the null reference when none has been registered.
- `boolean getFeature(String name)` returns the Boolean value that corresponds to the feature identified by name, which must be a fully-qualified URI. This method throws `org.xml.sax.SAXNotRecognizedException` when the name isn't recognized as a feature, and it throws `org.xml.sax.SAXNotSupportedException` when the name is recognized but the associated value cannot be determined when `getFeature()` is called. `SAXNotRecognizedException` and `SAXNotSupportedException` are subclasses of `SAXException`.
- `Object getProperty(String name)` returns the `java.lang.Object` instance that corresponds to the property identified by name, which must be a fully-qualified URI. This method throws `SAXNotRecognizedException` when the name isn't recognized as a property, and throws `SAXNotSupportedException` when the name is recognized but the associated value cannot be determined when `getProperty()` is called.
- `void parse(DataSource input)` parses an XML document and doesn't return until the document has been parsed. The `input` parameter stores a reference to an `org.xml.sax.DataSource` instance, which describes the document's source (such as a `java.io.InputStream` instance, or even a `java.lang.String`-based system identifier URI). This method throws `java.io.IOException` when the source cannot be read and `SAXException` when parsing fails, probably due to a well-formedness violation.
- `void parse(String systemId)` parses an XML document by executing `parse(new DataSource(systemId));`.
- `void setContentHandler(ContentHandler handler)` registers the content handler identified by `handler` with the parser. The `ContentHandler` interface provides 11 callback methods that are called to report various parsing events (such as the start and end of an element).
- `void setDTDHandler(DTDHandler handler)` registers the DTD handler identified by `handler` with the parser. The `DTDHandler` interface provides a pair of callback methods for reporting on notations and external unparsed entities.
- `void setEntityResolver(EntityResolver resolver)` registers the entity resolver identified by `resolver` with the parser. The `EntityResolver` interface provides a single callback method for resolving entities.
- `void setErrorHandler(ErrorHandler handler)` registers the error handler identified by `handler` with the parser. The `ErrorHandler` interface provides three callback methods that report *fatal errors* (problems that prevent further parsing, such as well-formedness violations), *recoverable errors* (problems that don't prevent further parsing, such as validation failures), and *warnings* (nonerrors that need to be addressed, such as prefixing an element name with the W3C-reserved `xml` prefix).

- `void setFeature(String name, boolean value)` assigns value to the feature identified by name, which must be a fully-qualified URI. This method throws `SAXNotRecognizedException` when the name isn't recognized as a feature, and it throws `SAXNotSupportedException` when the name is recognized but the associated value cannot be set when `setFeature()` is called.
- `void setProperty(String name, Object value)` assigns value to the property identified by name, which must be a fully-qualified URI. This method throws `SAXNotRecognizedException` when the name isn't recognized as a property, and it throws `SAXNotSupportedException` when the name is recognized but the associated value cannot be set when `setProperty()` is called.

When a handler isn't installed, all events pertaining to that handler are silently ignored. Not installing an error handler can be problematic because normal processing might not continue and the application wouldn't be aware that anything had gone wrong. When an entity resolver isn't installed, the parser performs its own default resolution. I'll have more to say about entity resolution later in this chapter.

**Note** You can install a new content handler, DTD handler, entity resolver, or error handler while the document is being parsed. The parser starts using the handler when the next event occurs.

After obtaining an `XMLReader` instance, you can configure that instance by setting its features and properties. A *feature* is a name-value pair that describes a parser mode, such as validation. In contrast, a *property* is a name-value pair that describes some other aspect of the parser interface, such as a lexical handler that augments the content handler by providing callback methods for reporting on comments, CDATA delimiters, and a few other syntactic constructs.

Features and properties have names, which must be absolute URIs beginning with the `http://` prefix. A feature's value is always a Boolean `true/false` value. In contrast, a property's value is an arbitrary object. The following example demonstrates setting a feature and a property:

```
xmlr.setFeature("http://xml.org/sax/features/validation", true);
xmlr.setProperty("http://xml.org/sax/properties/lexical-handler",
    new LexicalHandler() { /* ... */ });
```

The `setFeature()` call enables the `validation` feature so that the parser will perform validation. Feature names are prefixed with `http://xml.org/sax/features/`.



**Note** Parsers must support the namespaces and namespace-prefixes features. `namespaces` decides whether URIs and local names are passed to `ContentHandler`'s `startElement()` and `endElement()` methods. It defaults to `true`; these names are passed. The parser can pass empty strings when `false`. `namespace-prefixes` decides whether a namespace declaration's `xmlns` and `xmlns:prefix` attributes are included in the `Attributes` list passed to `startElement()`, and it also decides whether qualified names are passed as the method's third argument; a *qualified name* is a prefix plus a local name. It defaults to `false`, meaning that `xmlns` and `xmlns:prefix` aren't included, and meaning that parsers don't have to pass qualified names. No properties are mandatory. The JDK documentation's `org.xml.sax` package page lists standard SAX 2 features and properties.

The `setProperty()` call assigns an instance of a class that implements the `org.xml.sax.ext.LexicalHandler` interface to the `lexical-handler` property so that interface methods can be called to report on comments, CDATA sections, and so on. Property names are prefixed with `http://xml.org/sax/properties/`.

**Note** Unlike `ContentHandler`, `DTDHandler`, `EntityResolver`, and `ErrorHandler`, `LexicalHandler` is an extension (it's not part of the core SAX API), which is why `XMLReader` doesn't declare a `void setLexicalHandler(LexicalHandler handler)` method. If you want to install a lexical handler, you must use `XMLReader`'s `setProperty()` method to install the handler as the value of the `http://xml.org/sax/properties/lexical-handler` property.

Features and properties can be read-only or read-write. (In some rare cases, a feature or property might be write-only.) When setting or reading a feature or property, `SAXNotSupportedException` or `SAXNotRecognizedException` might be thrown. For example, if you try to modify a read-only feature/property, an instance of the `SAXNotSupportedException` class is thrown. This exception could also be thrown if you call `setFeature()` or `setProperty()` during parsing. Trying to set the validation feature for a parser that doesn't perform validation is a scenario where an instance of the `SAXNotRecognizedException` class is thrown.

The handlers installed by `setContentHandler()`, `setDTDHandler()`, and `setErrorHandler()`, the entity resolver installed by `setEntityResolver()`, and the handler installed by the `lexical-handler` property/`LexicalHandler` interface provide various callback methods that you need to understand before you can codify them to respond effectively to parsing events. `ContentHandler` declares the following content-oriented informational callback methods:

- `void characters(char[] ch, int start, int length)` reports an element's character data via the `ch` array. The arguments that are passed to `start` and `length` identify that portion of the array that's relevant to this method call. Characters are passed via a `char[]` array instead of via a `String` instance as a performance optimization. Parsers commonly store a large amount of the document in an array and repeatedly pass a reference to this array along with updated `start` and `length` values to `characters()`.

- `void endDocument()` reports that the end of the document has been reached. An application might use this method to close an output file or perform some other cleanup.
- `void endElement(String uri, String localName, String qName)` reports that the end of an element has been reached. `uri` identifies the element's namespace URI, or it is empty when there is no namespace URI or namespace processing hasn't been enabled. `localName` identifies the element's local name, which is the name without a prefix (the `html` in `html` or `h:html`, for example). `qName` references the qualified name, for example, `h:html` or `html` when there is no prefix. `endElement()` is invoked when an end tag is detected, or immediately following `startElement()` when an empty-element tag is detected.
- `void endPrefixMapping(String prefix)` reports that the end of a namespace prefix mapping (`xmlns:h`, for example) has been reached, and `prefix` reports this prefix (`h`, for example).
- `void ignorableWhitespace(char[] ch, int start, int length)` reports *ignorable whitespace* (whitespace located between tags where the DTD doesn't allow mixed content). This whitespace is often used to indent tags. The parameters serve the same purpose as those in the `characters()` method.
- `void processingInstruction(String target, String data)` reports a processing instruction in which `target` identifies the application to which the instruction is directed and `data` provides the instruction's data (the null reference when there is no data).
- `void setDocumentLocator(Locator locator)` reports an `org.xml.sax.Locator` object (an instance of a class implementing the `Locator` interface) whose `int getColumnNumber()`, `int getLineNumber()`, `String getPublicId()`, and `String getSystemId()` methods can be called to obtain location information at the end position of any document-related event, even when the parser isn't reporting an error. This method is called before `startDocument()`, and it is a good place to save the `Locator` object so that it can be accessed from other callback methods.
- `void skippedEntity(String name)` reports all skipped entities. Validating parsers resolve all general entity references, but nonvalidating parsers have the option of skipping them because nonvalidating parsers don't read DTDs where these entities are declared. If the nonvalidating parser doesn't read a DTD, it will not know if an entity is properly declared. Instead of attempting to read the DTD and report the entity's replacement text, the nonvalidating parser calls `skippedEntity()` with the entity's name.
- `void startDocument()` reports that the start of the document has been reached. An application might use this method to create an output file or perform some other initialization.
- `void startElement(String uri, String localName, String qName, Attributes attributes)` reports that the start of an element has been reached. `uri` identifies the element's namespace URI or is empty when there is no namespace URI or namespace processing hasn't been enabled. `localName` identifies the element's local name, `qName` references its qualified name, and `attributes` references an

array of `org.xml.sax.Attribute` objects that identify the element's attributes; this array is empty when there are no attributes. `startElement()` is invoked when a start tag or an empty-element tag is detected.

- `void startPrefixMapping(String prefix, String uri)` reports that the start of a namespace prefix mapping (`xmlns:h="http://www.w3.org/1999/xhtml"`, for example) has been reached in which `prefix` reports this prefix (such as `h`) and `uri` reports the URI to which the prefix is mapped (`http://www.w3.org/1999/xhtml`, for example).

Each method except for `setDocumentLocator()` is declared to throw `SAXException`, which an overriding callback method might choose to throw when it detects a problem.

`DTDHandler` declares the following DTD-oriented informational callback methods:

- `void notationDecl(String name, String publicId, String systemId)` reports a notation declaration, in which `name` provides this declaration's name attribute value, `publicId` provides this declaration's public attribute value (the null reference when this value isn't available), and `systemId` provides this declaration's system attribute value.
- `void unparsedEntityDecl(String name, String publicId, String systemId, String notationName)` reports an external unparsed entity declaration in which `name` provides the value of this declaration's name attribute, `publicId` provides the value of the public attribute (the null reference when this value isn't available), `systemId` provides the value of the system attribute, and `notationName` provides the NDATA name.

Each method is declared to throw `SAXException`, which an overriding callback method might choose to throw when it detects a problem.

`EntityResolver` declares the following callback method:

- `InputSource resolveEntity(String publicId, String systemId)` is called to let the application resolve an external entity (such as an external DTD subset) by returning a custom `InputSource` instance that's based on a different URI. This method is declared to throw `SAXException` when it detects a SAX-oriented problem, and it is also declared to throw `IOException` when it encounters an I/O error, possibly in response to creating an `InputStream` instance or a `java.io.Reader` instance for the `InputSource` being created.

`ErrorHandler` declares the following error-oriented informational callback methods:

- `void error(SAXParseException exception)` reports that a recoverable parser error (typically the document isn't valid) has occurred; the details are specified via the argument passed to `exception`. This method is typically overridden to report the error via a command window or to log it to a file or a database.
- `void fatalError(SAXParseException exception)` reports that an unrecoverable parser error (the document isn't well formed) has occurred; the details are specified via the argument passed to `exception`. This method is typically overridden so that the application can log the error before it stops processing the document (because the document is no longer reliable).

- `void warning(SAXParseException e)` reports that a nonserious error (such as an element name beginning with the reserved `xml` character sequence) has occurred; the details are specified via the argument passed to exception. This method is typically overridden to report the warning via a console or to log it to a file or a database.

Each method is declared to throw `SAXException`, which an overriding callback method might choose to throw when it detects a problem.

`LexicalHandler` declares the following additional content-oriented informational callback methods:

- `void comment(char[] ch, int start, int length)` reports a comment via the `ch` array. The arguments that are passed to `start` and `length` identify that portion of the array that's relevant to this method call.
- `void endCDATA()` reports the end of a CDATA section.
- `void endDTD()` reports the end of a DTD.
- `void endEntity(String name)` reports the start of the entity identified by name.
- `void startCDATA()` reports the start of a CDATA section.
- `void startDTD(String name, String publicId, String systemId)` reports the start of the DTD identified by name. `publicId` specifies the declared public identifier for the external DTD subset or is the null reference when none was declared. Similarly, `systemId` specifies the declared system identifier for the external DTD subset or is the null reference when none was declared.
- `void startEntity(String name)` reports the start of the entity identified by name.

Each method is declared to throw `SAXException`, which an overriding callback method might choose to throw when it detects a problem.

Because it can be tedious to implement all of the methods in each interface, the SAX API conveniently provides the `org.xml.sax.helpers.DefaultHandler` adapter class to relieve you of this tedium. `DefaultHandler` implements `ContentHandler`, `DTDHandler`, `EntityResolver`, and `ErrorHandler`. SAX also provides `org.xml.sax.ext.DefaultHandler2`, which subclasses `DefaultHandler` and which also implements `LexicalHandler`.

## Demonstrating the SAX API

Listing 15-10 presents the source code to `SAXDemo`, an application that demonstrates the SAX API. The application consists of a `SAXDemo` entry-point class and a `Handler` subclass of `DefaultHandler2`.

*Listing 15-10. SAXDemo*

```
import java.io.FileReader;
import java.io.IOException;

import org.xml.sax.InputSource;
import org.xml.sax.SAXException;
import org.xml.sax.XMLReader;
```

```
import org.xml.sax.helpers.XMLReaderFactory;

public class SAXDemo
{
    public static void main(String[] args)
    {
        if (args.length < 1 || args.length > 2)
        {
            System.err.println("usage: java SAXDemo xmlfile [v]");
            return;
        }
        try
        {
            XMLReader xmlr = XMLReaderFactory.createXMLReader();
            if (args.length == 2 && args[1].equals("v"))
                xmlr.setFeature("http://xml.org/sax/features/validation", true);
            xmlr.setFeature("http://xml.org/sax/features/namespace-prefixes",
                true);
            Handler handler = new Handler();
            xmlr.setContentHandler(handler);
            xmlr.setDTDHandler(handler);
            xmlr.setEntityResolver(handler);
            xmlr.setErrorHandler(handler);
            xmlr.setProperty("http://xml.org/sax/properties/lexical-handler", handler);
            xmlr.parse(new InputSource(new FileReader(args[0])));
        }
        catch (IOException ioe)
        {
            System.err.println("IOE: " + ioe);
        }
        catch (SAXException saxe)
        {
            System.err.println("SAXE: " + saxe);
        }
    }
}
```

SAXDemo's main() method first verifies that one or two command-line arguments (the name of an XML document optionally followed by lowercase letter v, which tells SAXDemo to create a validating parser) have been specified. It then creates an XMLReader instance; conditionally enables the validation feature and enables the namespace-prefixes feature; instantiates the companion Handler class; installs this Handler instance as the parser's content handler, DTD handler, entity resolver, and error handler; installs this Handler instance as the value of the lexical-handler property; creates an input source to read the document from a file; and parses the document.

The Handler class's source code is presented in Listing 15-11.

*Listing 15-11. Handler*

```
import org.xml.sax.Attributes;
import org.xml.sax.InputSource;
import org.xml.sax.Locator;
import org.xml.sax.SAXParseException;

import org.xml.sax.ext.DefaultHandler2;

public class Handler extends DefaultHandler2
{
    private Locator locator;

    @Override
    public void characters(char[] ch, int start, int length)
    {
        System.out.print("characters() [");
        for (int i = start; i < start + length; i++)
            System.out.print(ch[i]);
        System.out.println("]");
    }

    @Override
    public void comment(char[] ch, int start, int length)
    {
        System.out.print("characters() [");
        for (int i = start; i < start + length; i++)
            System.out.print(ch[i]);
        System.out.println("]");
    }

    @Override
    public void endCDATA()
    {
        System.out.println("endCDATA()");
    }

    @Override
    public void endDocument()
    {
        System.out.println("endDocument()");
    }

    @Override
    public void endDTD()
    {
        System.out.println("endDTD()");
    }
}
```

```
@Override
public void endElement(String uri, String localName, String qName)
{
    System.out.print("endElement() ");
    System.out.print("uri=[" + uri + "], ");
    System.out.print("localName=[" + localName + "], ");
    System.out.println("qName=[" + qName + ""]");
}

@Override
public void endEntity(String name)
{
    System.out.print("endEntity() ");
    System.out.println("name=[" + name + ""]");
}

@Override
public void endPrefixMapping(String prefix)
{
    System.out.print("endPrefixMapping() ");
    System.out.println("prefix=[" + prefix + ""]");
}

@Override
public void error(SAXParseException saxpe)
{
    System.out.println("error() " + saxpe);
}

@Override
public void fatalError(SAXParseException saxpe)
{
    System.out.println("fatalError() " + saxpe);
}

@Override
public void ignorableWhitespace(char[] ch, int start, int length)
{
    System.out.print("ignorableWhitespace() [");
    for (int i = start; i < start + length; i++)
        System.out.print(ch[i]);
    System.out.println("]");
}

@Override
public void notationDecl(String name, String publicId, String systemId)
{
    System.out.print("notationDecl() ");
    System.out.print("name=[" + name + ""]");
    System.out.print("publicId=[" + publicId + ""]");
    System.out.println("systemId=[" + systemId + ""]");
}
```

```
@Override
public void processingInstruction(String target, String data)
{
    System.out.print("processingInstruction() [");
    System.out.println("target=[" + target + "]);
    System.out.println("data=[" + data + "]);
}

@Override
public InputSource resolveEntity(String publicId, String systemId)
{
    System.out.print("resolveEntity() ");
    System.out.print("publicId=[" + publicId + "]);
    System.out.println("systemId=[" + systemId + "]);
    // Do not perform a remapping.
    InputSource is = new InputSource();
    is.setPublicId(publicId);
    is.setSystemId(systemId);
    return is;
}

@Override
public void setDocumentLocator(Locator locator)
{
    System.out.print("setDocumentLocator() ");
    System.out.println("locator=[" + locator + "]);
    this.locator = locator;
}

@Override
public void skippedEntity(String name)
{
    System.out.print("skippedEntity() ");
    System.out.println("name=[" + name + "]);
}

@Override
public void startCDATA()
{
    System.out.println("startCDATA()");
}

@Override
public void startDocument()
{
    System.out.println("startDocument()");
}

@Override
public void startDTD(String name, String publicId, String systemId)
{
    System.out.print("startDTD() ");
```



```

        System.out.print("name=[" + name + "]);
        System.out.print("publicId=[" + publicId + "]);
        System.out.println("systemId=[" + systemId + "]);
    }

    @Override
    public void startElement(String uri, String localName, String qName,
        Attributes attributes)
    {
        System.out.print("startElement() ");
        System.out.print("uri=[" + uri + "], ");
        System.out.print("localName=[" + localName + "], ");
        System.out.println("qName=[" + qName + "]);
        for (int i = 0; i < attributes.getLength(); i++)
            System.out.println(" Attribute: " + attributes.getLocalName(i) + ", " +
                attributes.getValue(i));
        System.out.println("Column number=[" + locator.getColumnNumber() + "]);
        System.out.println("Line number=[" + locator.getLineNumber() + "]);
    }

    @Override
    public void startEntity(String name)
    {
        System.out.print("startEntity() ");
        System.out.println("name=[" + name + "]);
    }

    @Override
    public void startPrefixMapping(String prefix, String uri)
    {
        System.out.print("startPrefixMapping() ");
        System.out.print("prefix=[" + prefix + "]);
        System.out.println("uri=[" + uri + "]);
    }

    @Override
    public void unparsedEntityDecl(String name, String publicId,
        String systemId, String notationName)
    {
        System.out.print("unparsedEntityDecl() ");
        System.out.print("name=[" + name + "]);
        System.out.print("publicId=[" + publicId + "]);
        System.out.print("systemId=[" + systemId + "]);
        System.out.println("notationName=[" + notationName + "]);
    }

    @Override
    public void warning(SAXParseException saxpe)
    {
        System.out.println("warning() " + saxpe);
    }
}

```

The Handler subclass is pretty straightforward; it outputs every possible piece of information about an XML document, subject to feature and property settings. You'll find this class handy for exploring the order in which events occur along with various features and properties.

After compiling `SAXDemo.java` and `Handler.java` (`javac SAXDemo.java`), execute the following command to parse Listing 15-4's `svg-examples.xml` document:

```
java SAXDemo svg-examples.xml
```

`SAXDemo` responds by presenting the following output (the hash code may be different):

```
setDocumentLocator() locator=[com.sun.org.apache.xerces.internal.parsers.AbstractSAXParser$LocatorP
roxy@1395ddb]
startDocument()
startElement() uri=[], localName=[svg-examples], qName=[svg-examples]
Column number=[15]
Line number=[2]
characters() [
]
startElement() uri=[], localName=[example], qName=[example]
Column number=[13]
Line number=[3]
characters() [
    The following Scalable Vector Graphics document describes a blue-filled and ]
characters() [
    black-stroked rectangle.
]
startCDATA()
characters() [<svg width="100%" height="100%" version="1.1"
    xmlns="http://www.w3.org/2000/svg">
    <rect width="300" height="100"
        style="fill:rgb(0,0,255);stroke-width:1; stroke:rgb(0,0,0)"/>
    </svg>]
endCDATA()
characters() [
]
endElement() uri=[], localName=[example], qName=[example]
characters() [
]
endElement() uri=[], localName=[svg-examples], qName=[svg-examples]
endDocument()
```

The first output line proves that `setDocumentLocator()` is called first. It also identifies the Locator instance whose `getColumnNumber()` and `getLineNumber()` methods are called to output the parser location when `startElement()` is called; these methods return column and line numbers starting at 1.

Perhaps you're curious about the three instances of the following output:

```
characters() [
]
```

The instance of this output that follows the `endCDATA()` output is reporting a carriage return/line feed combination that wasn't included in the preceding `characters()` method call, which was passed the contents of the CDATA section minus these line terminator characters. In contrast, the instances of this output that follow the `startElement()` call for `svg-examples` and follow the `endElement()` call for example are somewhat curious. There's no content between `<svg-examples>` and `<example>`, and between `</example>` and `</svg-examples>`, or is there?

You can satisfy this curiosity by modifying `svg-examples.xml` to include an internal DTD. Place the following DTD (which indicates that an `svg-examples` element contains one or more `example` elements, and that an `example` element contains parsed character data) between the XML declaration and the `<svg-examples>` start tag:

```
<!DOCTYPE svg-examples [
<!ELEMENT svg-examples (example+)>
<!ELEMENT example (#PCDATA)>
]>
```

Continuing, execute the following command:

```
java SAXDemo svg-examples.xml
```

This time, you should see the following output (although the hash code will probably differ):

```
setDocumentLocator() locator=[com.sun.org.apache.xerces.internal.parsers.AbstractSAXParser$LocatorP
roxy@540fe861]
startDocument()
startDTD() name=[svg-examples]publicId=[null]systemId=[null]
endDTD()
startElement() uri=[], localName=[svg-examples], qName=[svg-examples]
Column number=[15]
Line number=[6]
ignorableWhitespace() [
]
startElement() uri=[], localName=[example], qName=[example]
Column number=[13]
Line number=[7]
characters() [
    The following Scalable Vector Graphics document describes a blue-filled and
    black-stroked rectangle.]
characters() [
]
startCDATA()
characters() [<svg width="100%" height="100%" version="1.1"
    xmlns="http://www.w3.org/2000/svg">
    <rect width="300" height="100"
        style="fill:rgb(0,0,255);stroke-width:1; stroke:rgb(0,0,0)"/>
    </svg>]
endCDATA()
characters() [
]
```

```

endElement() uri=[], localName=[example], qName=[example]
ignorableWhitespace() [
]
endElement() uri=[], localName=[svg-examples], qName=[svg-examples]
endDocument()

```

This output reveals that the `ignorableWhitespace()` method was called after `startElement()` for `svg-examples` and after `endElement()` for `example`. The former two calls to `characters()` that produced the strange output were reporting ignorable whitespace.

Recall that I previously defined *ignorable whitespace* as whitespace located between tags where the DTD doesn't allow mixed content. For example, the DTD indicates that `svg-examples` shall contain only `example` elements, not `example` elements and parsed character data. However, the line terminator following the `<svg-examples>` tag and the leading whitespace before `<example>` are parsed character data. The parser now reports these characters by calling `ignorableWhitespace()`.

This time, there are only two occurrences of the following output:

```

characters() [
]

```

The first occurrence reports the line terminator separately from the `example` element's text (before the CDATA section); it didn't do so previously, which proves that `characters()` is called with either all or part of an element's content. Once again, the second occurrence reports the line terminator that follows the CDATA section.

Let's validate `svg-examples.xml` without the previously presented internal DTD. You'll do so by executing the following command; don't forget to include the `v` command-line argument or the document won't validate:

```
java SAXDemo svg-examples.xml v
```

Among its output are a couple of `error()`-prefixed lines that are similar to those shown below:

```

error() org.xml.sax.SAXParseException; lineNumber: 2; columnNumber: 14; Document is invalid: no
grammar found.
error() org.xml.sax.SAXParseException; lineNumber: 2; columnNumber: 14; Document root element "svg-
examples", must match DOCTYPE root "null".

```

These lines reveal that a DTD grammar hasn't been found. Furthermore, the parser reports a mismatch between `svg-examples` (it considers the first encountered element to be the root element) and `null` (it considers `null` to be the name of the root element in the absence of a DTD). Neither violation is considered to be fatal, which is why `error()` is called instead of `fatalError()`.

Add the internal DTD to `svg-examples.xml` and re-execute `java SAXDemo svg-examples.xml v`. This time, you should see no `error()`-prefixed lines in the output.

**Tip** SAX 2 validation defaults to validating against a DTD. To validate against an XML Schema-based schema instead, add the `schemaLanguage` property with the <http://www.w3.org/2001/XMLSchema> value to the `XMLReader` instance. Accomplish this task for `SAXDemo` by specifying `xmlr.setProperty("http://java.sun.com/xml/jaxp/properties/schemaLanguage", "http://www.w3.org/2001/XMLSchema");` before `xmlr.parse(new InputSource(new FileReader(args[0])));`

## Creating a Custom Entity Resolver

While exploring XML, I introduced you to the concept of *entities*, which are aliased data. Then I discussed general entities and parameter entities in terms of their internal and external variants.

Unlike internal entities, whose values are specified in a DTD, the values of external entities are specified outside of a DTD and are identified via public and/or system identifiers. The system identifier is a URI, whereas the public identifier is a formal public identifier.

An XML parser reads an external entity (including the external DTD subset) via an `InputSource` instance that's connected to the appropriate system identifier. In many cases, you pass a system identifier or `InputSource` instance to the parser and let it discover where to find other entities that are referenced from the current document entity.

However, for performance or other reasons, you might want the parser to read the external entity's value from a different system identifier, such as a local DTD copy's system identifier. You can accomplish this task by creating an *entity resolver* that uses the public identifier to choose a different system identifier. Upon encountering an external entity, the parser calls the custom entity resolver to obtain this identifier.

Consider Listing 15-12's formal specification of Listing 15-1's grilled cheese sandwich recipe.

### *Listing 15-12. XML-Based Recipe for a Grilled Cheese Sandwich Specified in Recipe Markup Language*

```
<?xml version="1.0" encoding="UTF-8"?>
<!DOCTYPE recipeml PUBLIC "-//FormatData//DTD RecipeML 0.5//EN"
    "http://www.formatdata.com/ recipeml/ recipeml.dtd">
<recipeml version="0.5">
  <recipe>
    <head>
      <title>Grilled Cheese Sandwich</title>
    </head>
    <ingredients>
      <ing>
        <amt><qty>2</qty><unit>slice</unit></amt>
        <item>bread</item>
      </ing>
      <ing>
        <amt><qty>1</qty><unit>slice</unit></amt>
        <item>cheese</item>
      </ing>
    </ingredients>
  </recipe>
</recipeml>
```

```

    <ing>
      <amt><qty>2</qty><unit>pat</unit></amt>
      <item>margarine</item>
    </ing>
  </ingredients>
  <directions>
    <step>Place frying pan on element and select medium heat.</step>
    <step>For each bread slice, smear one pat of margarine on one side of
      bread slice.</step>
    <step>Place cheese slice between bread slices with margarine-smearred
      sides away from the cheese.</step>
    <step>Place sandwich in frying pan with one margarine-smearred size in
      contact with pan.</step>
    <step>Fry for a couple of minutes and flip.</step>
    <step>Fry other side for a minute and serve.</step>
  </directions>
</recipe>
</recipeml>

```

Listing 15-12 specifies the grilled cheese sandwich recipe in *Recipe Markup Language (RecipeML)*, an XML-based language for marking up recipes. (A company named FormatData [see [www.formatdata.com](http://www.formatdata.com)] released this format in 2000.)

The document type declaration reports `-//FormatData//DTD RecipeML 0.5//EN` as the formal public identifier and <http://www.formatdata.com/recipeml/recipeml.dtd> as the system identifier. Instead of keeping the default mapping, let's map this formal public identifier to `recipeml.dtd`, a system identifier for a local copy of this DTD file.

To create a custom entity resolver to perform this mapping, you declare a class that implements the `EntityResolver` interface in terms of its `resolveEntity(String publicId, String systemId)` method. You then use the passed `publicId` value as a key into a map that points to the desired `systemId` value, and then use this value to create and return a custom `InputSource`. Listing 15-13 presents the resulting class.

**Listing 15-13. LocalRecipeML**

```

import java.util.HashMap;
import java.util.Map;

import org.xml.sax.EntityResolver;
import org.xml.sax.InputSource;
import org.xml.sax.SAXException;

public class LocalRecipeML implements EntityResolver
{
    private Map<String, String> mappings = new HashMap<String, String>();

    LocalRecipeML()
    {
        mappings.put("-//FormatData//DTD RecipeML 0.5//EN", "recipeml.dtd");
    }
}

```

```

@Override
public InputSource resolveEntity(String publicId, String systemId)
{
    if (mappings.containsKey(publicId))
    {
        System.out.println("obtaining cached recipeml.dtd");
        systemId = mappings.get(publicId);
        InputSource localSource = new InputSource(systemId);
        return localSource;
    }
    return null;
}
}

```

Listing 15-13 declares `LocalRecipeML`. This class's constructor stores the formal public identifier for the RecipeML DTD and the system identifier for a local copy of this DTD's document in a map.

**Note** Although it's unnecessary to use a map in this example (an `if (publicId.equals("-//FormatData//DTD RecipeML 0.5//EN")) return new InputSource("recipeml.dtd") else return null;` statement would suffice), I've chosen to use a map in case I want to expand the number of mappings in the future. In another scenario, you would probably find a map to be very convenient. For example, it's easier to use a map than to use a series of `if` statements in a custom entity resolver that maps XHTML's strict, transitional, and frameset formal public identifiers, and that also maps its various entity sets to local copies of these document files.

The overriding `resolveEntity()` method uses `publicId`'s argument to locate the corresponding system identifier in the map; the `systemId` parameter value is ignored because it never refers to the local copy of `recipeml.dtd`. When the mapping is found, an `InputSource` object is created and returned. If the mapping couldn't be found, the null reference would be returned.

To install this custom entity resolver in `SAXDemo`, specify `xmlr.setEntityResolver(new LocalRecipeML());` before the `parse()` method call. After recompiling the source code, execute the following command:

```
java SAXDemo gcs.xml
```

Here, `gcs.xml` stores Listing 15-12's text. In the resulting output, you should observe the message "obtaining cached recipeml.dtd" before the call to `startEntity()`.

**Tip** The SAX API includes an `org.xml.sax.ext.EntityResolver2` interface that provides improved support for resolving entities. If you prefer to implement `EntityResolver2` instead of `EntityResolver`, replace the `setEntityResolver()` call to install the entity resolver with a `setFeature()` call whose feature name is `use-entity-resolver2` (don't forget the <http://xml.org/sax/features/> prefix).

## Parsing and Creating XML Documents with DOM

*Document Object Model (DOM)* is an API for parsing an XML document into an in-memory tree of nodes and for creating an XML document from a tree of nodes. After a DOM parser has created a document tree, an application uses the DOM API to navigate over and extract infoset items from the tree's nodes.

**Note** DOM originated as an object model for the Netscape Navigator 3 and Microsoft Internet Explorer 3 web browsers. Collectively, these implementations are known as DOM Level 0. Because each vendor's DOM implementation was only slightly compatible with the other, the W3C subsequently took charge of DOM's development to promote standardization, and has so far released DOM Levels 1, 2, and 3 (with Level 4 under development). Java 7 and newer versions of Android support all three DOM levels through their DOM APIs.

DOM has two big advantages over SAX. First, DOM permits random access to a document's infoset items whereas SAX only permits serial access. Second, DOM lets you also create XML documents whereas you can only parse documents with SAX. However, SAX is advantageous over DOM in that it can parse documents of arbitrary size, whereas the size of documents parsed or created by DOM is limited by the amount of available memory for storing the document's node-based tree structure.

In this section, I first introduce you to DOM's tree structure. I then take you on a tour of the DOM API; you learn how to use this API to parse and create XML documents.

### A Tree of Nodes

DOM views an XML document as a tree that's composed of several kinds of nodes. This tree has a single root node, and all nodes except for the root have a parent node. Also, each node has a list of child nodes. When this list is empty, the child node is known as a *leaf node*.

**Note** DOM permits nodes to exist that are not part of the tree structure. For example, an element node's attribute nodes are not regarded as child nodes of the element node. Also, nodes can be created but not inserted into the tree; they can also be removed from the tree.

Each node has a *node name*, which is the complete name for nodes that have names (such as an element's or an attribute's prefixed name), and *#node-type* for unnamed nodes, where *node-type* is one of *cdata-section*, *comment*, *document*, *document-fragment*, or *text*. Nodes also have *local names* (names without prefixes), prefixes, and namespace URIs (although these attributes may be null for certain kinds of nodes, such as comments). Finally, nodes have string values, which happen to be the content of text nodes, comment nodes, and similar text-oriented nodes; normalized values of attributes; and null for everything else.



DOM classifies nodes into 12 types, of which seven types can be considered part of a DOM tree. All of these types are described below:

- *Attribute node*: One of an element's attributes. It has a name, a local name, a prefix, a namespace URI, and a normalized string value. The value is *normalized* by resolving any entity references and by converting sequences of whitespace to a single whitespace character. An attribute node has children, which are the text and any entity reference nodes that form its value. Attributes nodes are not regarded as children of their associated element nodes.
- *CDATA section node*: The contents of a CDATA section. Its name is `#cdata-section`, and its value is the CDATA section's text.
- *Comment node*: A document comment. Its name is `#comment`, and its value is the comment text. A comment node has a parent, which is the node that contains the comment.
- *Document node*: The root of a DOM tree. Its name is `#document`, it always has a single element node child, and it will also have a document type child node when the document has a document type declaration. Furthermore, it can have additional child nodes describing comments or processing instructions that appear before or after the root element's start tag. There can be only one document node in the tree.
- *Document fragment node*: An alternative root node. Its name is `#document-fragment`, and it contains anything that an element node can contain (such as other element nodes and even comment nodes). A parser never creates this kind of a node. However, an application can create a document fragment node when it extracts part of a DOM tree to be moved somewhere else. Document fragment nodes let you work with subtrees.
- *Document type node*: A document type declaration. Its name is the name specified by the document type declaration for the root element. Also, it has a (possibly null) public identifier, a required system identifier, an internal DTD subset (which is possibly null), a parent (the document node that contains the document type node), and lists of DTD-declared notations and general entities. Its value is always set to null.
- *Element node*: A document's element. It has a name, a local name, a (possibly null) prefix, and a namespace URI, which is null when the element doesn't belong to any namespace. An element node contains children, including text nodes, and even comment and processing instruction nodes.
- *Entity node*: The parsed and unparsed entities that are declared in a document's DTD. When a parser reads a DTD, it attaches a map of entity nodes (indexed by entity name) to the document type node. An entity node has a name and a system identifier, and it can also have a public identifier if one appears in the DTD. Finally, when the parser reads the entity, the entity node is given a list of read-only child nodes that contain the entity's replacement text.

- *Entity reference node*: A reference to a DTD-declared entity. Each entity reference node has a name, and it is included in the tree when the parser doesn't replace entity references with their values. The parser never includes entity reference nodes for character references (such as `&amp;` or `&#0931;`) because they're replaced by their respective characters and included in a text node.
- *Notation node*: A DTD-declared notation. A parser that reads the DTD attaches a map of notation nodes (indexed by notation name) to the document type node. Each notation node has a name and a public identifier or a system identifier, whichever identifier was used to declare the notation in the DTD. Notation nodes don't have children.
- *Processing instruction node*: A processing instruction that appears in the document. It has a name (the instruction's target), a string value (the instruction's data), and a parent (its containing node).
- *Text node*: Document content. Its name is `#text`, and it represents a portion of an element's content when an intervening node (such as a comment) must be created. Characters such as `<` and `&` that are represented in the document via character references are replaced by the literal characters they represent. When these nodes are written to a document, these characters must be escaped.

Although these node types store considerable information about an XML document, there are limitations (such as not exposing whitespace outside of the root element). In contrast, most DTD or schema information, such as element types (`<!ELEMENT...>`) and attribute types (`<x:s:attribute...>`), cannot be accessed through the DOM.

DOM Level 3 addresses some of the DOM's various limitations. For example, although DOM doesn't provide a node type for the XML declaration, DOM Level 3 makes it possible to access the XML declaration's version, encoding, and standalone attribute values via attributes of the document node.

**Note** Nonroot nodes never exist in isolation. For example, it's never the case for an element node not to belong to a document or to a document fragment. Even when such nodes are disconnected from the main tree, they remain aware of the document or document fragment to which they belong.

## Exploring the DOM API

Java implements DOM through the `javax.xml.parsers` package's abstract `DocumentBuilder` and `DocumentBuilderFactory` classes along with the nonabstract `FactoryConfigurationError` and `ParserConfigurationException` classes. The `org.w3c.dom`, `org.w3c.dom.bootstrap` (not supported by Android), `org.w3c.dom.events` (not supported by Android), and `org.w3c.dom.ls` packages provide various types that augment this implementation.

The first step in working with DOM is to instantiate `DocumentBuilderFactory` by calling one of its `newInstance()` methods. For example, the following code fragment invokes `DocumentBuilderFactory`'s `DocumentBuilderFactory.newInstance()` class method:

```
DocumentBuilderFactory dbf = DocumentBuilderFactory.newInstance();
```

Behind the scenes, `newInstance()` follows an ordered lookup procedure to identify the `DocumentBuilderFactory` implementation class to load. This procedure first examines the `javax.xml.parsers.DocumentBuilderFactory` system property and lastly chooses the Java platform's default `DocumentBuilderFactory` implementation class when no other class is found. If an implementation class isn't available (perhaps the class identified by the `javax.xml.parsers.DocumentBuilderFactory` system property doesn't exist) or cannot be instantiated, `newInstance()` throws an instance of the `FactoryConfigurationError` class. Otherwise, it instantiates the class and returns its instance.

After obtaining a `DocumentBuilderFactory` instance, you can call various configuration methods to configure the factory. For example, you could call `DocumentBuilderFactory`'s void `setNamespaceAware(boolean awareness)` method with a `true` argument to tell the factory that any returned parser (known as a *document builder* to DOM) must provide support for XML namespaces. You can also call void `setValidating(boolean validating)` with `true` as the argument to validate documents against their DTDs, or call void `setSchema(Schema schema)` to validate documents against the `javax.xml.validation.Schema` instance identified by `schema`.

## VALIDATION API

`Schema` is a member of the Validation API, which decouples document parsing from validation, making it easier for applications to take advantage of specialized validation libraries that support additional schema languages (such as Relax NG—see [http://en.wikipedia.org/wiki/RELAX\\_NG](http://en.wikipedia.org/wiki/RELAX_NG)), and also making it easier to specify the location of a schema.

The Validation API is associated with the `javax.xml.validation` package, which also includes `SchemaFactory`, `SchemaFactoryLoader`, `TypeInfoProvider`, `Validator`, and `ValidatorHandler`. `Schema` is the central class, and it represents an immutable in-memory representation of a grammar.

DOM supports the Validation API via `DocumentBuilderFactory`'s void `setSchema(Schema schema)` and `Schema` `getSchema()` methods. Similarly, SAX 1.0 supports Validation via `SAXParserFactory`'s void `setSchema(Schema schema)` and `Schema` `getSchema()` methods. SAX 2.0 and StAX don't support the Validation API.

The following example provides a demonstration of the Validation API in a DOM context:

```
// Parse an XML document into a DOM tree.
DocumentBuilder parser =
    DocumentBuilderFactory.newInstance().newDocumentBuilder();
Document document = parser.parse(new File("instance.xml"));
// Create a SchemaFactory capable of understanding W3C XML Schema (WXS).
SchemaFactory factory =
    SchemaFactory.newInstance(XMLConstants.W3C_XML_SCHEMA_NS_URI);
// Load a WXS schema, represented by a Schema instance.
Source schemaFile = new StreamSource(new File("mySchema.xsd"));
Schema schema = factory.newSchema(schemaFile);
// Create a Validator instance, which is used to validate an XML document.
Validator validator = schema.newValidator();
// Validate the DOM tree.
try
```

```

{
    validator.validate(new DOMSource(document));
}
catch (SAXException saxe)
{
    // XML document is invalid!
}

```

This example refers to XSLT types such as `Source`. I explore XSLT later in this chapter.

After the factory has been configured, call its `DocumentBuilder newDocumentBuilder()` method to return a document builder that supports the configuration, as demonstrated here:

```
DocumentBuilder db = dbf.newDocumentBuilder();
```

If a document builder cannot be returned (perhaps the factory cannot create a document builder that supports XML namespaces), this method throws a `ParserConfigurationException` instance.

Assuming that you've successfully obtained a document builder, what happens next depends upon whether you want to parse or create an XML document.

## Parsing XML Documents

`DocumentBuilder` provides several overloaded `parse()` methods for parsing an XML document into a node tree. These methods differ in how they obtain the document. For example, `Document parse(String uri)` parses the document that's identified by its string-based URI argument.

**Note** Each `parse()` method throws `java.lang.IllegalArgumentException` when `null` is passed as the method's first argument, `IOException` when an input/output problem occurs, and `SAXException` when the document cannot be parsed. This last exception type implies that `DocumentBuilder`'s `parse()` methods rely on SAX to take care of the actual parsing work. Because they are more involved in building the node tree, DOM parsers are commonly referred to as *document builders*.

The returned `org.w3c.dom.Document` object provides access to the parsed document through methods such as `DocumentType getDoctype()`, which makes the document type declaration available through the `org.w3c.dom.DocumentType` interface. Conceptually, `Document` is the root of the document's node tree.

**Note** Apart from `DocumentBuilder`, `DocumentBuilderFactory`, and a few other classes, DOM is based on interfaces, of which `Document` and `DocumentType` are examples. Behind the scenes, DOM methods (such as the `parse()` methods) return objects whose classes implement these interfaces.

Document and all other `org.w3c.dom` interfaces that describe different kinds of nodes are subinterfaces of the `org.w3c.dom.Node` interface. As such, they inherit `Node`'s constants and methods.

`Node` declares 12 constants that represent the various kinds of nodes; `ATTRIBUTE_NODE` and `ELEMENT_NODE` are examples. When you want to identify the kind of node represented by a given `Node` object, call `Node`'s short `getNodeType()` method and compare the returned value to one of these constants.

**Note** The rationale for using `getNodeType()` and these constants, instead of using `instanceof` and a class name, is that DOM (the object model, not the Java DOM API) was designed to be language independent, and languages such as AppleScript don't have the equivalent of `instanceof`.

`Node` declares several methods for getting and setting common node properties. These methods include `String getNodeName()`, `String getLocalName()`, `String getNamespaceURI()`, `String getPrefix()`, `void setPrefix(String prefix)`, `String getNodeValue()`, and `void setNodeValue(String nodeValue)`, which let you get and (for some properties) set a node's name (such as `#text`), local name, namespace URI, prefix, and normalized string value properties.

**Note** Various `Node` methods (such as `setPrefix()` and `getNodeValue()`) throw an instance of the `org.w3c.dom.DOMException` class when something goes wrong. For example, `setPrefix()` throws this exception when the `prefix` argument contains an illegal character, the node is read-only, or the argument is malformed. Similarly, `getNodeValue()` throws `DOMException` when `getNodeValue()` would return more characters than can fit into a `DOMString` (a W3C type) variable on the implementation platform. `DOMException` declares a series of constants (such as `DOMSTRING_SIZE_ERR`) that classify the reason for the exception.

`Node` declares several methods for navigating the node tree. Three of its navigation methods are as follows:

- `boolean hasChildNodes()` returns `true` when a node has child nodes.
- `Node getFirstChild()` returns the node's first child.
- `Node getLastChild()` returns the node's last child.

For nodes with multiple children, you'll find the `NodeList getChildNodes()` method to be handy. This method returns an `org.w3c.dom.NodeList` instance whose `int getLength()` method returns the number of nodes in the list and whose `Node item(int index)` method returns the node at the `index`th position in the list (or `null` when `index`'s value isn't valid; it's less than 0 or greater than or equal to `getLength()`'s value).

Node declares four methods for modifying the tree by inserting, removing, replacing, and appending child nodes:

- Node `insertBefore(Node newChild, Node refChild)` inserts `newChild` before the existing node specified by `refChild` and returns `newChild`.
- Node `removeChild(Node oldChild)` removes the child node identified by `oldChild` from the tree and returns `oldChild`.
- Node `replaceChild(Node newChild, Node oldChild)` replaces `oldChild` with `newChild` and returns `oldChild`.
- Node `appendChild(Node newChild)` adds `newChild` to the end of the current node's child nodes and returns `newChild`.

Finally, Node declares several utility methods, including Node `cloneNode(boolean deep)` (create and return a duplicate of the current node, recursively cloning its subtree when `true` is passed to `deep`), and void `normalize()` (descend the tree from the given node and merge all adjacent text nodes, deleting those text nodes that are empty).

**Tip** To obtain an element node's attributes, first call Node's `NamedNodeMap getAttributes()` method. This method returns an `org.w3c.dom.NamedNodeMap` implementation when the node represents an element; otherwise, it returns `null`. Along with declaring methods for accessing these nodes by name (such as Node `getNamedItem(String name)`), `NamedNodeMap` declares `int getLength()` and Node `item(int index)` methods for returning all attribute nodes by index. You would then obtain the Node's name by calling a method such as `getNodeName()`.

Beyond inheriting Node's constants and methods, Document declares its own methods. For example, you can call Document's `String getXmlEncoding()`, `boolean getXmlStandalone()`, and `String getXmlVersion()` methods to return the XML declaration's encoding, standalone, and version attribute values, respectively.

Document declares three methods for locating one or more elements:

- Element `getElementById(String elementId)` returns the element that has an `id` attribute (as in `<img id=...>`) matching the value specified by `elementId`.
- `NodeList getElementsByTagName(String tagName)` returns a `nodelist` of a document's elements (in document order) matching the specified `tagName`.
- `NodeList getElementsByTagNameNS(String namespaceURI, String localName)` is essentially the same as the second method except that only elements matching the given `localName` and `namespaceURI` are returned in the `nodelist`. Pass `"*"` to `namespaceURI` to match all namespaces; pass `"*"` to `localName` to match all local names.

The returned element node and each element node in the list implement the `org.w3c.dom.Element` interface. This interface declares methods to return nodelists of descendent elements in the tree, attributes associated with the element, and more. For example, `String getAttribute(String name)` returns the value of the attribute identified by name, whereas `Attr getAttributeNode(String name)` returns an attribute node by name. The returned node is an implementation of the `org.w3c.dom.Attr` interface.

You now have enough information to explore an application for parsing an XML document and outputting the element and attribute information from the resulting DOM tree. Listing 15-14 presents this application's source code.

*Listing 15-14. DOMDemo (Version 1)*

```
import java.io.IOException;

import javax.xml.parsers.DocumentBuilder;
import javax.xml.parsers.DocumentBuilderFactory;
import javax.xml.parsers.FactoryConfigurationError;
import javax.xml.parsers.ParserConfigurationException;

import org.w3c.dom.Attr;
import org.w3c.dom.Document;
import org.w3c.dom.Element;
import org.w3c.dom.NamedNodeMap;
import org.w3c.dom.Node;
import org.w3c.dom.NodeList;

import org.xml.sax.SAXException;

public class DOMDemo
{
    public static void main(String[] args)
    {
        if (args.length != 1)
        {
            System.err.println("usage: java DOMDemo xmlfile");
            return;
        }
        try
        {
            DocumentBuilderFactory dbf = DocumentBuilderFactory.newInstance();
            dbf.setNamespaceAware(true);
            DocumentBuilder db = dbf.newDocumentBuilder();
            Document doc = db.parse(args[0]);
            System.out.printf("Version = %s%n", doc.getXmlVersion());
            System.out.printf("Encoding = %s%n", doc.getXmlEncoding());
            System.out.printf("Standalone = %b%n%n", doc.getXmlStandalone());
            if (doc.hasChildNodes())
            {
                NodeList nl = doc.getChildNodes();
                for (int i = 0; i < nl.getLength(); i++)
                {
```

```

        Node node = nl.item(i);
        if (node.getNodeType() == Node.ELEMENT_NODE)
            dump((Element) node);
    }
}
}
catch (IOException ioe)
{
    System.err.println("IOE: " + ioe);
}
catch (SAXException saxe)
{
    System.err.println("SAXE: " + saxe);
}
catch (FactoryConfigurationError fce)
{
    System.err.println("FCE: " + fce);
}
catch (ParserConfigurationException pce)
{
    System.err.println("PCE: " + pce);
}
}

static void dump(Element e)
{
    System.out.printf("Element: %s, %s, %s, %s\n", e.getNodeName(),
        e.getLocalName(), e.getPrefix(), e.getNamespaceURI());
    NamedNodeMap nnm = e.getAttributes();
    if (nnm != null)
        for (int i = 0; i < nnm.getLength(); i++)
        {
            Node node = nnm.item(i);
            Attr attr = e.getAttributeNode(node.getNodeName());
            System.out.printf(" Attribute %s = %s\n", attr.getName(),
                attr.getValue());
        }
    NodeList nl = e.getChildNodes();
    for (int i = 0; i < nl.getLength(); i++)
    {
        Node node = nl.item(i);
        if (node instanceof Element)
            dump((Element) node);
    }
}
}
}

```

DOMDemo's `main()` method first verifies that one command line argument (the name of an XML document) has been specified. It then creates a document builder factory, informs the factory that it wants a namespace-aware document builder, and has the factory return this document builder.



Continuing, `main()` parses the document into a node tree; outputs the XML declaration's version number, encoding, and standalone attribute values; and recursively dumps all element nodes (starting with the root node) and their attribute values.

Notice the use of `getNodeTypes()` in one part of this listing and `instanceof` in another part. The `getNodeTypes()` method call isn't necessary (it's only present for demonstration) because `instanceof` can be used instead. However, the cast from `Node` type to `Element` type in the `dump()` method calls is necessary.

Compile this source code (`javac DOMDemo.java`), and run the application to dump Listing 15-3's article XML content as follows:

```
java DOMDemo article.xml
```

You should observe the following output:

```
Version = 1.0
Encoding = null
Standalone = false

Element: article, article, null, null
  Attribute lang = en
  Attribute title = The Rebirth of JavaFX
Element: abstract, abstract, null, null
Element: code-inline, code-inline, null, null
Element: body, body, null, null
```

Each `Element`-prefixed line outputs the node name, followed by the local name, followed by the namespace prefix, followed by the namespace URI. The node and local names are identical because namespaces aren't being used. For the same reason, the namespace prefix and namespace URI are null.

Continuing on, execute the following command line to dump Listing 15-5's recipe content:

```
java DOMDemo recipe.xml
```

This time, you observe the following output, which includes namespace information:

```
Version = 1.0
Encoding = null
Standalone = false

Element: h:html, html, h, http://www.w3.org/1999/xhtml
  Attribute xmlns:h = http://www.w3.org/1999/xhtml
  Attribute xmlns:r = http://www.tutortutor.ca/
Element: h:head, head, h, http://www.w3.org/1999/xhtml
Element: h:title, title, h, http://www.w3.org/1999/xhtml
Element: h:body, body, h, http://www.w3.org/1999/xhtml
Element: r:recipe, recipe, r, http://www.tutortutor.ca/
Element: r:title, title, r, http://www.tutortutor.ca/
Element: r:ingredients, ingredients, r, http://www.tutortutor.ca/
```

```

Element: h:ul, ul, h, http://www.w3.org/1999/xhtml
Element: h:li, li, h, http://www.w3.org/1999/xhtml
Element: r:ingredient, ingredient, r, http://www.tutortutor.ca/
  Attribute qty = 2
Element: h:li, li, h, http://www.w3.org/1999/xhtml
Element: r:ingredient, ingredient, r, http://www.tutortutor.ca/
Element: h:li, li, h, http://www.w3.org/1999/xhtml
Element: r:ingredient, ingredient, r, http://www.tutortutor.ca/
  Attribute qty = 2
Element: h:p, p, h, http://www.w3.org/1999/xhtml
Element: r:instructions, instructions, r, http://www.tutortutor.ca/

```

## Creating XML Documents

DocumentBuilder declares the abstract Document `newDocument()` method for creating a document tree. The returned Document object declares various “create” and other methods for creating this tree. For example, Element `createElement(String tagName)` creates an element named by `tagName`, returning a new Element object with the specified name but with its local name, prefix, and namespace URI set to null.

Listing 15-15 presents another version of the DOMDemo application that briefly demonstrates the creation of a document tree.

### *Listing 15-15. DOMDemo (Version 2)*

```

import javax.xml.parsers.DocumentBuilder;
import javax.xml.parsers.DocumentBuilderFactory;
import javax.xml.parsers.FactoryConfigurationError;
import javax.xml.parsers.ParserConfigurationException;

import org.w3c.dom.Document;
import org.w3c.dom.Element;
import org.w3c.dom.Node;
import org.w3c.dom.NodeList;
import org.w3c.dom.Text;

public class DOMDemo
{
    public static void main(String[] args)
    {
        try
        {
            DocumentBuilderFactory dbf = DocumentBuilderFactory.newInstance();
            DocumentBuilder db = dbf.newDocumentBuilder();
            Document doc = db.newDocument();
            // Create the root element.
            Element root = doc.createElement("movie");
            doc.appendChild(root);
            // Create name child element and add it to the root.
            Element name = doc.createElement("name");
            root.appendChild(name);
        }
    }
}

```

```

    // Add a text element to the name element.
    Text text = doc.createTextNode("Le Fabuleux Destin d'Amélie Poulain");
    name.appendChild(text);
    // Create language child element and add it to the root.
    Element language = doc.createElement("language");
    root.appendChild(language);
    // Add a text element to the language element.
    text = doc.createTextNode("français");
    language.appendChild(text);
    System.out.printf("Version = %s%n", doc.getXmlVersion());
    System.out.printf("Encoding = %s%n", doc.getXmlEncoding());
    System.out.printf("Standalone = %b%n%n", doc.getXmlStandalone());
    NodeList nl = doc.getChildNodes();
    for (int i = 0; i < nl.getLength(); i++)
    {
        Node node = nl.item(i);
        if (node.getNodeType() == Node.ELEMENT_NODE)
            dump((Element) node);
    }
}
catch (FactoryConfigurationError fce)
{
    System.err.println("FCE: " + fce);
}
catch (ParserConfigurationException pce)
{
    System.err.println("PCE: " + pce);
}
}

static void dump(Element e)
{
    System.out.printf("Element: %s, %s, %s, %s%n", e.getNodeName(),
        e.getLocalName(), e.getPrefix(), e.getNamespaceURI());
    NodeList nl = e.getChildNodes();
    for (int i = 0; i < nl.getLength(); i++)
    {
        Node node = nl.item(i);
        if (node instanceof Element)
            dump((Element) node);
        else
            if (node instanceof Text)
                System.out.printf("Text: %s%n", ((Text) node).getWholeText());
    }
}
}
}

```

DOMDemo creates Listing 15-2's movie document. It uses Document's `createElement()` method to create the root movie element and movie's name and language child elements. It also uses Document's `Text createTextNode(String data)` method to create text nodes that are attached to the name and language nodes. Notice the calls to Node's `appendChild()` method to append child nodes (such as name) to parent nodes (such as movie).

After creating this tree, DOMDemo outputs the tree's element nodes and other information. This output appears as follows:

```
Version = 1.0
Encoding = null
Standalone = false

Element: movie, null, null, null
Element: name, null, null, null
Text: Le Fabuleux Destin d'Amélie Poulain
Element: language, null, null, null
Text: français
```

The output is pretty much as expected, but there's one problem: the XML declaration's encoding attribute hasn't been set to ISO-8859-1. You cannot accomplish this task via the DOM API. Instead, you need to use the XSLT API. While exploring XSLT, you'll learn how to set the encoding attribute, and you'll also learn how to output this tree to an XML document file.

However, there's one more document-parsing API to explore (and a tour of the XPath API to take) before we turn our attention to XSLT.

## Parsing XML Documents with XMLPULL V1

SAX is an example of a *push parser*, which pushes parsing events to an application. The application provides a handler that responds to these events. The parser invokes the handler's callback methods to execute application-specific code as XML constructs are detected. Although push parsing is simple to implement, it often results in applications that are hard to write and debug.

To avoid SAX's nonintuitiveness, you can use DOM to parse a document into an in-memory tree of nodes. However, the maximum size of this tree (and document) is constrained by available memory.

There's a third option for parsing XML documents that overcomes SAX's and DOM's disadvantages. A *pull parser* lets an application pull parsed XML constructs, one at a time, from the parser when these constructs are needed. Unlike a push parser, which drives the application, a pull parser is driven by the application. Applications that use pull parsing are easier to write and debug.

Java 6 formally introduced pull parsing via Streaming API for XML (StAX). StAX supports two forms of pull parsing: event-based and stream-based. It also lets you create XML documents. Google ignored StAX and chose the simpler *XMLPULL V1* for its pull parser API. Unlike StAX, XMLPULL V1 supports event-based pull parsing only. Also, it doesn't let you create XML documents.

Because XMLPULL V1 isn't included with Oracle Java, you'll need to download a JAR file before trying out this section's example application. Complete the following steps to accomplish this task.

1. Point your browser to [www.java2s.com/Code/Jar/x/Downloadxmlpullxpp3114cjar.htm](http://www.java2s.com/Code/Jar/x/Downloadxmlpullxpp3114cjar.htm).
2. Click the `xmlpull/xmlpull-xpp3-1.1.4c.jar.zip` (109 k) (or equivalent) link.

You should end up with an `xmlpull-xpp3-1.1.4c.jar` file (or a later version of this file), which you will add to your CLASSPATH environment variable (or specify via the `-classpath/-cp` command-line option) when compiling or running this section's example application.

XMLPULL V1 consists of an `org.xmlpull.v1` package that contains the following types:

- `XmlPullParserFactory`: A class that lets you create and return instances of the XMLPULL parser.
- `XmlPullParser`: An interface that defines parsing functionality provided in XMLPULL V1.
- `XmlPullParserException`: A class that signals XML parsing problems. This exception is widely thrown throughout the API.

Listing 15-16 presents the source code for a simple application that demonstrates these types.

*Listing 15-16. XMLPPDemo*

```
import java.io.FileReader;
import java.io.IOException;

import org.xmlpull.v1.XmlPullParser;
import org.xmlpull.v1.XmlPullParserException;
import org.xmlpull.v1.XmlPullParserFactory;

public class XMLPPDemo
{
    public static void main (String args[])
        throws IOException, XmlPullParserException
    {
        if (args.length != 1)
        {
            System.err.println("usage: java XMLPPDemo xmlfilespec");
            return;
        }

        XmlPullParserFactory factory = XmlPullParserFactory.newInstance();
        factory.setNamespaceAware(true);
        XmlPullParser xpp = factory.newPullParser();

        xpp.setInput(new FileReader(args[0]));
        int eventType = xpp.getEventType();
        while (eventType != XmlPullParser.END_DOCUMENT)
        {
            switch (eventType)
            {
                case XmlPullParser.START_DOCUMENT:
                    System.out.println("Start document");
                    break;

                case XmlPullParser.START_TAG:
                    System.out.println("Start tag " + xpp.getName());
                    break;
            }
        }
    }
}
```

```

        case XmlPullParser.TEXT:
            System.out.println("Text " + xpp.getText());
            break;

        case XmlPullParser.END_TAG:
            System.out.println("End tag " + xpp.getName());
    }
    eventType = xpp.next();
}
}
}
}
}

```

Listing 15-16 describes an XMLPPDemo application that parses the XML file identified by its single command-line argument.

After verifying that a single command-line argument has been specified, `main()` invokes `XmlPullParserFactory`'s `XmlPullParserFactory newInstance()` class method to create and return a new `XmlPullParserFactory` instance for creating XML pull parsers. `XmlPullParserException` is thrown when an `XmlPullParserFactory` implementation class cannot be found.

Next, `void setNamespaceAware(boolean awareness)` is invoked with a `true` argument to tell the XML pull parser factory to create only a parser that supports XML namespaces.

At this point, `XmlPullParser newPullParser()` is invoked to create and return a new `XmlPullParser` instance using the currently-configured factory parameters.

`XmlPullParser` declares a `void setInput(Reader reader)` method that sets the parser's input source to the specified reader. In this example, the command-line argument is passed to a `java.io.FileReader` constructor and the `FileReader` instance is passed to `setInput()`, to signify that XML content will be read from the file.

`XmlPullParser` declares a `int getEventType()` method that returns the current event type. The following integer-based event type constants are provided:

- `START_DOCUMENT`: The parser is at the very beginning of the document and nothing has yet been read. This is the initial event type after `setInput()` is called.
- `START_TAG`: A tag has been read. Invoke `XmlPullParser`'s `String getName()` method to return the tag's local name and `String getPrefix()` to return any prefix. You can invoke various "getAttribute" methods to return attribute information.
- `TEXT`: Character data has been read and can be obtained by calling `XmlPullParser`'s `String getText()` method.
- `END_TAG`: The end tag has just been read.
- `END_DOCUMENT`: The parser has reached the logical end of the document; attempting to read another item results in `XmlPullParserException` being thrown.

`main()`'s final task is to enter a while loop that executes while the current event type doesn't equal `END_DOCUMENT`. The loop first outputs information about the event. It then invokes `XmlPullParser`'s `int next()` method to obtain the next parser event.

Execute the following command line to compile Listing 15-16:

```
javac -cp xmlpull-xpp3-1.1.4c.jar XMLPPDemo.java
```

Assuming that Listing 15-3's `article.xml` file is located in the current directory, execute the following command line to parse this file:

```
java -cp xmlpull-xpp3-1.1.4c.jar;. XMLPPDemo article.xml
```

You should observe the following output:

---

```
Start document
Start tag article
Text

Start tag abstract
Text
    JavaFX 2.0 marks a significant milestone in the history of JavaFX. Now that
    Sun Microsystems has passed the torch to Oracle, we have seen the demise of
    JavaFX Script and the emerge of Java APIs (such as

Start tag code-inline
Text javafx.application.Application
End tag code-inline
Text ) for interacting
    with this technology. This article introduces you to this new flavor of
    JavaFX, where you learn about JavaFX 2.0 architecture and key APIs.

End tag abstract
Text

Start tag body
Text

End tag body
Text

End tag article
```

---

For more information about XMLPULL V1, check out Android's `org.xmlpull.v1` package documentation at <http://developer.android.com/reference/org/xmlpull/v1/package-summary.html>. Also, you might want to check out the documentation at [www.xmlpull.org/v1/doc/api/org/xmlpull/v1/package-summary.html](http://www.xmlpull.org/v1/doc/api/org/xmlpull/v1/package-summary.html).

## Selecting XML Document Nodes with XPath

*XPath* is a non-XML declarative query language (defined by the W3C) for selecting an XML document's infoset items as one or more nodes. For example, you can use XPath to locate Listing 15-1's third ingredient element and return this element node.

XPath is often used to simplify access to a DOM tree's nodes, and it is also used in the context of XSLT (discussed in the next section) where it's typically employed to select those input document elements (via XPath expressions) that are to be copied to an output document. Java and Android support XPath 1.0, which is assigned package `javax.xml.xpath`.

In this section, I first acquaint you with the XPath language. I then demonstrate how XPath simplifies the selection of a DOM tree's nodes. Lastly, I introduce three advanced XPath topics: namespace contexts, extension functions and function resolvers, and variables and variable resolvers.

### XPath Language Primer

XPath views an XML document as a tree of nodes that starts from a root node. XPath recognizes seven kinds of nodes: element, attribute, text, namespace, processing instruction, comment, and document. XPath doesn't recognize CDATA sections, entity references, or document type declarations.

**Note** A tree's root node (a DOM Document instance) isn't the same as a document's root element. The root node contains the entire document, including the root element, any comments or processing instructions that appear before the root element's start tag and any comments or processing instructions that appear after the root element's end tag.

### Location Path Expressions

XPath provides location path expressions for selecting nodes. A *location path expression* locates nodes via a sequence of *steps* starting from the *context node* (the root node or some other document node that's the current node). The returned set of nodes, which is known as a *nodeset*, might be empty, or it might contain one or more nodes.

The simplest location path expression selects the document's root node and consists of a single forward slash character (`/`). The next simplest location path expression is the name of an element, which selects all child elements of the context node that have that name. For example, `ingredient` refers to all ingredient child elements of the context node in Listing 15-1's XML document. This XPath expression returns a set of three ingredient nodes when the context node is ingredients. However, if `recipe` or `instructions` happened to be the context node, `ingredient` wouldn't return any nodes (ingredient is a child of ingredients only). When an expression starts with a forward slash (`/`), the expression represents an absolute path that starts from the root node. For example, expression `/movie` selects all movie child elements of the root node in Listing 15-2's XML document.

Attributes are also handled by location path expressions. To select an element's attribute, specify `@` followed by the attribute's name. For example, `@qty` selects the qty attribute node of the context node.



In most cases, you'll work with root nodes, element nodes, and attribute nodes. However, you might also need to work with namespace nodes, text nodes, processing-instruction nodes, and comment nodes. Unlike namespace nodes, which are typically handled by XSLT, you'll more likely need to process comments, text, and processing instructions. XPath provides `comment()`, `text()`, and `processing-instruction()` functions for selecting comment, text, and processing-instruction nodes.

The `comment()` and `text()` functions don't require arguments because comment and text nodes don't have names. Each comment is a separate comment node, and each text node specifies the longest run of text not interrupted by a tag. The `processing-instruction()` function may be called with an argument that identifies the target of the processing instruction. If called with no argument, all of the context node's processing-instruction child nodes are selected.

XPath provides three wildcards for selecting unknown nodes:

- `*` matches any element node regardless of the node's type. It doesn't match attributes, text nodes, comments, or processing-instruction nodes. When you place a namespace prefix before the `*`, only elements belonging to that namespace are matched.
- `node()` is a function that matches all nodes.
- `@*` matches all attribute nodes.

**Note** XPath lets you perform multiple selections by using the vertical bar (`|`). For example, `author/*|publisher/*` selects the children of `author` and the children of `publisher`, and `*|@*` matches all elements and attributes, but doesn't match text, comment, or processing-instruction nodes.

XPath lets you combine steps into *compound paths* by using the `/` character to separate them. For paths beginning with `/`, the first path step is relative to the root node; otherwise, the first path step is relative to another context node. For example, `/movie/name` starts with the root node, selects all `movie` element children of the root node, and selects all `name` children of the selected `movie` nodes. If you wanted to return all text nodes of the selected `name` elements, you would specify `/movie/name/text()`.

Compound paths can include `//` to select nodes from all descendants of the context node (including the context node). When placed at the start of an expression, `//` selects nodes from the entire tree. For example, `//ingredient` selects all `ingredient` nodes in the tree.

As with filesystems that let you identify the current directory with a single period (`.`) and its parent directory with a double period (`..`), you can specify a single period to represent the current node and a double period to represent the parent of the current node. (You would typically use a single period in XSLT to indicate that you want to access the value of the currently-matched element.)

It might be necessary to narrow the selection of nodes returned by an XPath expression. For example, expression `/recipe/ingredients/ingredient` returns all `ingredient` nodes, but perhaps you only want to return the first `ingredient` node. You can narrow the selection by including predicates in the location path.

A *predicate* is a square bracket-delimited Boolean expression that's tested against each selected node. If the expression evaluates to true, that node is included in the set of nodes returned by the XPath expression; otherwise, the node isn't included in the set. For example, `/recipe/ingredients/ingredient[1]` selects the first `ingredient` element that's a child of the `ingredients` element.

Predicates can include predefined functions (such as `last()` and `position()`), operators (such as `-`, `<`, and `=`), and other items. Consider the following examples:

- `/recipe/ingredients/ingredient[last()]` selects the last ingredient element that's a child of the `ingredients` element.
- `/recipe/ingredients/ingredient[last() - 1]` selects the next-to-last ingredient element that's a child of the `ingredients` element.
- `/recipe/ingredients/ingredient[position() < 3]` selects the first two ingredient elements that are children of the `ingredients` element.
- `//ingredient[@qty]` selects all ingredient elements (no matter where they're located) that have `qty` attributes.
- `//ingredient[@qty='1']` or `//ingredient[@qty="1"]` selects all ingredient elements (no matter where they're located) that have `qty` attributes with value 1.

**Note** XPath predefines several functions for use with nodesets: `last()` returns a number identifying the last node, `position()` returns a number identifying a node's position, `count()` returns the number of nodes in its nodeset argument, `id()` selects elements by their unique IDs and returns a nodeset of these elements, `local-name()` returns the local part of the qualified name of the first node in its nodeset argument, `namespace-uri()` returns the namespace part of the qualified name of the first node in its nodeset argument, and `name()` returns the qualified name of the first node in its nodeset argument.

Although predicates are supposed to be Boolean expressions, the predicate might not evaluate to a Boolean value. For example, it could evaluate to a number or a string. XPath supports Boolean, number (IEEE 754 double precision floating-point values), and string expression types as well as a location path expression's nodeset type. If a predicate evaluates to a number, XPath converts that number to true when it equals the context node's position; otherwise, XPath converts that number to false. If a predicate evaluates to a string, XPath converts that string to true when the string isn't empty; otherwise, XPath converts that string to false. Finally, if a predicate evaluates to a nodeset, XPath converts that nodeset to true when the nodeset is nonempty; otherwise, XPath converts that nodeset to false.

**Note** The previously presented location path expression examples demonstrate XPath's abbreviated syntax. However, XPath also supports an unabbreviated syntax that's more descriptive of what's happening and is based on an *axis specifier* that indicates the navigation direction within the XML document's tree representation. For example, where `/movie/name` selects all `movie` child elements of the root node followed by all `name` child elements of the `movie` elements using the abbreviated syntax, `/child::movie/child::name` accomplishes the same task with the expanded syntax. Check out Wikipedia's "XPath" entry ([http://en.wikipedia.org/wiki/XPath\\_1.0](http://en.wikipedia.org/wiki/XPath_1.0)) for more information.

## General Expressions

Location path expressions (which return nodesets) are one kind of XPath expression. XPath also supports general expressions that evaluate to Boolean (such as predicates), number, or string type; for example, `position() = 2`, `6.8`, and `"Hello"`. General expressions are often used in XSLT.

XPath Boolean values can be compared via relational operators `<`, `<=`, `>`, `>=`, `=`, and `!=`. Boolean expressions can be combined by using operators `and` and `or`. Also, XPath predefines the following functions:

- `boolean()` returns a Boolean value for a number, string, or nodeset.
- `not()` returns true when its Boolean argument is false and vice-versa.
- `true()` returns true.
- `false()` returns false.
- `lang()` returns true or false depending on whether the language of the context node (as specified by `xml:lang` attributes) is the same as or is a sublanguage of the language specified by the argument string.

XPath numeric values can be manipulated via operators `+`, `-`, `*`, `div`, and `mod` (remainder)—forward slash cannot be used for division because it's used to separate location steps. All five operators behave like their Java language counterparts. XPath also predefines the following functions:

- `number()` converts its argument to a number.
- `sum()` returns the sum of the numeric values represented by the nodes in its nodeset argument.
- `floor()` returns the largest (closest to positive infinity) number that's not greater than its number argument and that's an integer.
- `ceiling()` returns the smallest (closest to negative infinity) number that's not less than its number argument and that's an integer.
- `round()` returns the number that's closest to the argument and that's an integer. When there are two such numbers, the one closest to positive infinity is returned.

XPath strings are ordered character sequences that are enclosed in single quotes or double quotes. A string literal cannot contain the same kind of quote that's also used to delimit the string. For example, a string that contains a single quote cannot be delimited with single quotes. XPath provides the `=` and `!=` operators for comparing strings. XPath also predefines the following functions:

- `string()` converts its argument to a string.
- `concat()` returns a concatenation of its string arguments.
- `starts-with()` returns true when its first argument string starts with its second argument string (and otherwise returns false).
- `contains()` returns true when its first argument string contains its second argument string (and otherwise returns false).

- `substring-before()` returns the substring of its first argument string that precedes the first occurrence of its second argument string in its first argument string or the empty string when its first argument string doesn't contain its second argument string.
- `substring-after()` returns the substring of its first argument string that follows the first occurrence of its second argument string in its first argument string or the empty string when its first argument string doesn't contain its second argument string.
- `substring()` returns the substring of its first (string) argument starting at the position specified in its second (number) argument with length specified in its third (number) argument.
- `string-length()` returns the number of characters in its string argument (or the length of the context node when converted to a string in the absence of an argument).
- `normalize-space()` returns the argument string with whitespace normalized by stripping leading and trailing whitespace and replacing sequences of whitespace characters by a single space (or performing the same action on the context node when converted to a string in the absence of an argument).
- `translate()` returns its first argument string with occurrences of characters in its second argument string replaced by the character at the corresponding position in its third argument string.

## XPath and DOM

Suppose you need someone in your home to purchase a bag of sugar. You could say, "Please buy me some sugar." Alternatively, you could say the following: "Please open the front door. Walk down to the sidewalk. Turn left. Walk up the sidewalk for three blocks. Turn right. Walk up the sidewalk one block. Enter the store. Go to aisle 7. Walk two meters down the aisle. Pick up a bag of sugar. Walk to a checkout counter. Pay for the sugar. Retrace your steps home." Most people would expect to receive the shorter instruction, right?

Traversing a DOM tree of nodes is similar to providing the longer sequence of instructions. In contrast, XPath lets you traverse this tree via a succinct instruction. To see this difference for yourself, consider a scenario where you have an XML-based contacts document that lists your various professional contacts. Listing 15-17 presents a trivial example of such a document.

### *Listing 15-17. XML-Based Contacts Database*

```
<?xml version="1.0"?>
<contacts>
  <contact>
    <name>John Doe</name>
    <city>Chicago</city>
    <city>Denver</city>
  </contact>
```

```
<contact>
  <name>Jane Doe</name>
  <city>New York</city>
</contact>
<contact>
  <name>Sandra Smith</name>
  <city>Denver</city>
  <city>Miami</city>
</contact>
<contact>
  <name>Bob Jones</name>
  <city>Chicago</city>
</contact>
</contacts>
```

Listing 15-17 reveals a simple XML grammar consisting of a contacts root element that contains a sequence of contact elements. Each contact element contains one name element and one or more city elements (various contacts travel frequently and spend a lot of time in each city). (To keep the example simple, I'm not providing a DTD or a schema.)

Suppose you want to locate and output the names of all contacts that live at least part of each year in Chicago. Listing 15-18 presents the source code to a DOMSearch application that accomplishes this task with the DOM API.

*Listing 15-18. Locating Chicago Contacts with the DOM API*

```
import java.io.IOException;

import java.util.ArrayList;
import java.util.List;

import javax.xml.parsers.DocumentBuilder;
import javax.xml.parsers.DocumentBuilderFactory;
import javax.xml.parsers.FactoryConfigurationError;
import javax.xml.parsers.ParserConfigurationException;

import org.w3c.dom.Document;
import org.w3c.dom.Element;
import org.w3c.dom.Node;
import org.w3c.dom.NodeList;

import org.xml.sax.SAXException;

public class DOMSearch
{
    public static void main(String[] args)
    {
        try
        {
            DocumentBuilderFactory dbf = DocumentBuilderFactory.newInstance();
            DocumentBuilder db = dbf.newDocumentBuilder();
            Document doc = db.parse("contacts.xml");
```

```
List<String> contactNames = new ArrayList<String>();
Nodelist contacts = doc.getElementsByTagName("contact");
for (int i = 0; i < contacts.getLength(); i++)
{
    Element contact = (Element) contacts.item(i);
    Nodelist cities = contact.getElementsByTagName("city");
    boolean chicago = false;
    for (int j = 0; j < cities.getLength(); j++)
    {
        Element city = (Element) cities.item(j);
        Nodelist children = city.getChildNodes();
        StringBuilder sb = new StringBuilder();
        for (int k = 0; k < children.getLength(); k++)
        {
            Node child = children.item(k);
            if (child.getNodeType() == Node.TEXT_NODE)
                sb.append(child.getNodeValue());
        }
        if (sb.toString().equals("Chicago"))
        {
            chicago = true;
            break;
        }
    }
    if (chicago)
    {
        Nodelist names = contact.getElementsByTagName("name");
        contactNames.add(names.item(0).getFirstChild().getNodeValue());
    }
}
for (String contactName: contactNames)
    System.out.println(contactName);
}
catch (IOException ioe)
{
    System.err.println("IOE: " + ioe);
}
catch (SAXException sax)
{
    System.err.println("SAXE: " + sax);
}
catch (FactoryConfigurationError fce)
{
    System.err.println("FCE: " + fce);
}
catch (ParserConfigurationException pce)
{
    System.err.println("PCE: " + pce);
}
}
```

After parsing `contacts.xml` and building the DOM tree, `main()` uses `Document`'s `getElementsByTagName()` method to return a `NodeList` of contact element nodes. For each member of this list, `main()` extracts the contact element node, and uses this node with `getElementsByTagName()` to return a `NodeList` of the contact element node's city element nodes.

For each member of the cities list, `main()` extracts the city element node, and uses this node with `getElementsByTagName()` to return a `NodeList` of the city element node's child nodes; there's only a single child text node in this example, but the presence of a comment or processing instruction would increase the number of child nodes. For example, `<city>Chicago<!--The windy city--></city>` increases the number of child nodes to 2.

If the child's node type indicates that it's a text node, the child node's value (obtained via `getNodeValue()`) is stored in a string builder. Only one child node is stored in the string builder in this example. If the builder's contents indicate that Chicago has been found, the `chicago` flag is set to true and execution leaves the cities loop.

If the `chicago` flag is set when the cities loop exits, the current contact element node's `getElementsByTagName()` method is called to return a `NodeList` of the contact element node's name element nodes (of which there should only be one, and which I could enforce through a DTD or schema). It's now a simple matter to extract the first item from this list, call `getFirstChild()` on this item to return the text node (I assume that only text appears between `<name>` and `</name>`), and call `getNodeValue()` on the text node to obtain its value, which is then added to the `contactNames` list.

After compiling this source code, run the application. You should observe the following output:

```
John Doe
Bob Jones
```

Traversing the DOM's tree of nodes is a tedious exercise at best and is error-prone at worst. Fortunately, XPath can greatly simplify this situation.

Before writing the XPath equivalent of Listing 15-18, it helps to define a location path expression. For this example, that expression is `//contact[city = "Chicago"]/name/text()`, which uses a predicate to select all contact nodes that contain a Chicago city node, then select all child name nodes from these contact nodes, and finally select all child text nodes from these name nodes.

Listing 15-19 presents the source code to an `XPathSearch` application that uses this XPath expression and the XPath API to locate Chicago contacts.

*Listing 15-19. Locating Chicago Contacts with the XPath API*

```
import java.io.IOException;

import javax.xml.parsers.DocumentBuilder;
import javax.xml.parsers.DocumentBuilderFactory;
import javax.xml.parsers.FactoryConfigurationError;
import javax.xml.parsers.ParserConfigurationException;

import javax.xml.xpath.XPath;
import javax.xml.xpath.XPathConstants;
import javax.xml.xpath.XPathException;
import javax.xml.xpath.XPathExpression;
import javax.xml.xpath.XPathFactory;
```

```

import org.w3c.dom.Document;
import org.w3c.dom.NodeList;

import org.xml.sax.SAXException;

public class XPathSearch
{
    public static void main(String[] args)
    {
        try
        {
            DocumentBuilderFactory dbf = DocumentBuilderFactory.newInstance();
            DocumentBuilder db = dbf.newDocumentBuilder();
            Document doc = db.parse("contacts.xml");
            XPathFactory xpf = XPathFactory.newInstance();
            XPath xp = xpf.newXPath();
            XPathExpression xpe;
            xpe = xp.compile("//contact[city = 'Chicago']/name/text()");
            Object result = xpe.evaluate(doc, XPathConstants.NODESET);
            NodeList nl = (NodeList) result;
            for (int i = 0; i < nl.getLength(); i++)
                System.out.println(nl.item(i).getNodeValue());
        }
        catch (IOException ioe)
        {
            System.err.println("IOE: " + ioe);
        }
        catch (SAXException sax)
        {
            System.err.println("SAXE: " + sax);
        }
        catch (FactoryConfigurationError fce)
        {
            System.err.println("FCE: " + fce);
        }
        catch (ParserConfigurationException pce)
        {
            System.err.println("PCE: " + pce);
        }
        catch (XPathException xpe)
        {
            System.err.println("XPE: " + xpe);
        }
    }
}

```

After parsing `contacts.xml` and building the DOM tree, `main()` instantiates `XPathFactory` by calling its `XPathFactory newInstance()` method. The resulting `XPathFactory` instance can be used to set features (such as secure processing, to process XML documents securely) by calling its void `setFeature(String name, boolean value)` method, to create an `XPath` object by calling its `XPath newXPath()` method, and more.



XPath declares an `XPathExpression compile(String expression)` method for compiling the specified expression (an XPath expression) and returning the compiled expression as an instance of a class that implements the `XPathExpression` interface. This method throws `XPathExpressionException` (a subclass of `XPathException`) when the expression cannot be compiled.

XPath also declares several overloaded `evaluate()` methods for immediately evaluating an expression and returning the result. Because it can take time to evaluate an expression, you might choose to compile a complex expression first (to boost performance) when you plan to evaluate this expression many times.

After compiling the expression, `main()` calls `XPathExpression`'s `Object evaluate(Object item, QName returnType)` method to evaluate the expression. The first argument is the context node for the expression, which happens to be a `Document` instance in the example. The second argument specifies the kind of object returned by `evaluate()` and is set to `XPathConstants.NODESET`, a qualified name for the XPath 1.0 nodeset type, which is implemented via DOM's `NodeList` interface.

**Note** The XPath API maps XPath's Boolean, number, string, and nodeset types to Java's `java.lang.Boolean`, `java.lang.Double`, `String`, and `NodeList` types, respectively. When calling an `evaluate()` method, you specify XPath types via `XPathConstants` constants (`BOOLEAN`, `NUMBER`, `STRING`, and `NODESET`), and the method takes care of returning an object of the appropriate type. `XPathConstants` also declares a `NODE` constant, which doesn't map to a Java type. Instead, it's used to tell `evaluate()` that you only want the resulting nodeset to contain a single node.

After casting `Object` to `NodeList`, `main()` uses this interface's `getLength()` and `item()` methods to traverse the nodelist. For each item in this list, `getNodeValue()` is called to return the node's value, which is subsequently output. `XPathSearch` generates the same output as `DOMSearch`.

## Advanced XPath

The XPath API provides three advanced features to overcome limitations with the XPath 1.0 language. These features are namespace contexts, extension functions and function resolvers, and variables and variable resolvers.

## Namespace Contexts

When an XML document's elements belong to a namespace (including the default namespace), any XPath expression that queries the document must account for this namespace. For nondefault namespaces, the expression doesn't need to use the same namespace prefix; it only needs to use the same URI. However, when a document specifies the default namespace, the expression must use a prefix even though the document doesn't use a prefix.

To appreciate this situation, suppose Listing 15-17's `<contacts>` tag was declared as follows to introduce a default namespace: `<contacts xmlns="http://www.tutortutor.ca/">`. Furthermore, suppose that Listing 15-19 included `dbf.setNamespaceAware(true)`; after the line that instantiates `DocumentBuilderFactory`. If you were to run the revised `XPathSearch` application against the revised `contacts.xml` file, you wouldn't see any output.

You can correct this problem by implementing `javax.xml.namespace.NamespaceContext` to map an arbitrary prefix to the namespace URI, and then registering this namespace context with the XPath instance. Listing 15-20 presents a minimal implementation of the `NamespaceContext` interface.

*Listing 15-20. Minimally Implementing NamespaceContext*

```
import java.util.Iterator;

import javax.xml.XMLConstants;

import javax.xml.namespace.NamespaceContext;

public class NSContext implements NamespaceContext
{
    @Override
    public String getNamespaceURI(String prefix)
    {
        if (prefix == null)
            throw new IllegalArgumentException("prefix is null");
        else
            if (prefix.equals("tt"))
                return "http://www.tutortutor.ca/";
            else
                return null;
    }

    @Override
    public String getPrefix(String uri)
    {
        return null;
    }

    @Override
    public Iterator getPrefixes(String uri)
    {
        return null;
    }
}
```

The `getNamespaceURI()` method is passed a prefix argument that must be mapped to a URI. If this argument is null, an `IllegalArgumentException` object must be thrown (according to the Java documentation). When the argument is the desired prefix value, the namespace URI is returned.

After instantiating the XPath class, you would instantiate `NSContext` and register this instance with the XPath instance by calling XPath's void `setNamespaceContext(NamespaceContext nsContext)` method. For example, you would specify `xp.setNamespaceContext(new NSContext());` after `XPath xp = xpf.newXPath();` to register the `NSContext` instance with `xp`.

All that's left to accomplish is to apply the prefix to the XPath expression, which now becomes `//tt:contact[tt:city='Chicago']/tt:name/text()` because the `contact`, `city`, and `name` elements are now part of the default namespace, whose URI is mapped to arbitrary prefix `tt` in the `NSContext` instance's `getNamespaceURI()` method.

Compile and run the revised `XPathSearch` application, and you'll see John Doe followed by Bob Jones on separate lines.

## Extension Functions and Function Resolvers

The XPath API lets you define functions (via Java methods) that extend XPath's predefined function repertoire by offering new features not already provided. These Java methods cannot have side effects because XPath functions can be evaluated multiple times and in any order. Furthermore, they cannot override predefined functions; a Java method with the same name as a predefined function is never executed.

Suppose you modify Listing 15-17's XML document to include a `birth` element that records a contact's date of birth information in YYYY-MM-DD format. Listing 15-21 shows the resulting XML file.

### *Listing 15-21. XML-Based Contacts Database with Birth Information*

```
<?xml version="1.0"?>
<contacts xmlns="http://www.tutortutor.ca/">
  <contact>
    <name>John Doe</name>
    <birth>1953-01-02</birth>
    <city>Chicago</city>
    <city>Denver</city>
  </contact>
  <contact>
    <name>Jane Doe</name>
    <birth>1965-07-12</birth>
    <city>New York</city>
  </contact>
  <contact>
    <name>Sandra Smith</name>
    <birth>1976-11-22</birth>
    <city>Denver</city>
    <city>Miami</city>
  </contact>
  <contact>
    <name>Bob Jones</name>
    <birth>1958-03-14</birth>
    <city>Chicago</city>
  </contact>
</contacts>
```

Now suppose that you want to select contacts based on birth information. For example, you only want to select contacts whose date of birth is greater than 1960-01-01. Because XPath doesn't provide this function for you, you decide to declare a `date()` extension function. Your first step is to declare a `Date` class that implements the `XPathFunction` interface (see Listing 15-22).

*Listing 15-22. An Extension Function for Returning a Date as a Milliseconds Value*

```

import java.text.ParsePosition;
import java.text.SimpleDateFormat;

import java.util.List;

import javax.xml.xpath.XPathFunction;
import javax.xml.xpath.XPathFunctionException;

import org.w3c.dom.Node;
import org.w3c.dom.NodeList;

public class Date implements XPathFunction
{
    private final static ParsePosition POS = new ParsePosition(0);

    private SimpleDateFormat sdf = new SimpleDateFormat("yyyy-mm-dd");

    @Override
    public Object evaluate(List args) throws XPathFunctionException
    {
        if (args.size() != 1)
            throw new XPathFunctionException("Invalid number of arguments");
        String value;
        Object o = args.get(0);
        if (o instanceof NodeList)
        {
            NodeList list = (NodeList) o;
            value = list.item(0).getTextContent();
        }
        else
            if (o instanceof String)
                value = (String) o;
            else
                throw new XPathFunctionException("Cannot convert argument type");
        POS.setIndex(0);
        return sdf.parse(value, POS).getTime();
    }
}

```

XPathFunction declares a single Object evaluate(List args) method that XPath calls when it needs to execute the extension function. evaluate() is passed a java.util.List of objects that describe the arguments that were passed to the extension function by the XPath evaluator. Furthermore, this method returns a value of a type appropriate to the extension function (date()'s long integer return type is compatible with XPath's number type).

The date() extension function is intended to be called with a single argument, which is either of type nodeset or of type string. This extension function throws XPathFunctionException when the number of arguments (as indicated by the list's size) isn't equal to 1.

When the argument is of type `NodeList` (a `nodeset`), the textual content of the first node in the `nodeset` is obtained; this content is assumed to be a date value in `YYYY-MM-DD` format (for brevity, I'm overlooking error checking). When the argument is of type `String`, it's assumed to be a date value in this format. Any other type of argument results in a thrown `XPathFunctionException` instance.

Date comparison is simplified by converting the date to a milliseconds value. This task is accomplished with the help of the `java.text.SimpleDateFormat` and `java.text.ParsePosition` classes. After resetting the `ParsePosition` object's index (via `setIndex(0)`), `SimpleDateFormat`'s `Date parse(String text, ParsePosition pos)` method is called to parse the string according to the pattern established when `SimpleDateFormat` was instantiated, and starting from the parse position identified by the `ParsePosition` index. This index is reset before the `parse()` method call because `parse()` updates this object's index.

The `parse()` method returns a `java.util.Date` instance whose `long getTime()` method is called to return the number of milliseconds represented by the parsed date. (I discuss `SimpleDateFormat`, `ParsePosition`, and `Date` in Chapter 16.)

After implementing the extension function, you need to create a *function resolver*, which is an object whose class implements the `XPathFunctionResolver` interface, and which tells the XPath evaluator about the extension function (or functions). Listing 15-23 presents the `DateResolver` class.

*Listing 15-23. A Function Resolver for the date() Extension Function*

```
import javax.xml.namespace.QName;

import javax.xml.xpath.XPathFunction;
import javax.xml.xpath.XPathFunctionResolver;

public class DateResolver implements XPathFunctionResolver
{
    private static final QName name = new QName("http://www.tutortutor.ca/",
                                                "date", "tt");

    @Override
    public XPathFunction resolveFunction(QName name, int arity)
    {
        if (name.equals(this.name) && arity == 1)
            return new Date();
        return null;
    }
}
```

`XPathFunctionResolver` declares a single `XPathFunction resolveFunction(QName functionName, int arity)` method that XPath calls to identify the name of the extension function and obtain an instance of a Java object whose `evaluate()` method implements the function.

The `functionName` parameter identifies the function's qualified name because all extension functions must live in a namespace and must be referenced via a prefix (which doesn't have to match the prefix in the document). As a result, you must also bind a namespace to the prefix via a namespace context (as demonstrated previously). The `arity` parameter identifies the number of arguments that the extension function accepts and is useful when overloading extension functions. If the `functionName` and `arity` values are acceptable, the extension function's Java class is instantiated and returned; otherwise, `null` is returned.

Finally, the function resolver class is instantiated and registered with the XPath instance by calling XPath's void `setXPathFunctionResolver(XPathFunctionResolver resolver)` method.

The following excerpt from Version 3 of this chapter's XPathSearch application (in this book's code archive) demonstrates all of these tasks in order to use `date()` in XPath expression `//tt:contact[tt:date(tt:birth) > tt:date('1960-01-01')]/tt:name/text()`, which returns only those contacts whose date of birth is greater than 1960-01-01 (Jane Doe followed by Sandra Smith):

```
DocumentBuilderFactory dbf = DocumentBuilderFactory.newInstance();
dbf.setNamespaceAware(true);
DocumentBuilder db = dbf.newDocumentBuilder();
Document doc = db.parse("contacts.xml");
XPathFactory xpf = XPathFactory.newInstance();
XPath xp = xpf.newXPath();
xp.setNamespaceContext(new NSContext());
xp.setXPathFunctionResolver(new DateResolver());
XPathExpression xpe;
String expr;
expr = "//tt:contact[tt:date(tt:birth) > tt:date('1960-01-01')]"+
      "/tt:name/text()";
xpe = xp.compile(expr);
Object result = xpe.evaluate(doc, XPathConstants.NODESET);
NodeList nl = (NodeList) result;
for (int i = 0; i < nl.getLength(); i++)
    System.out.println(nl.item(i).getNodeValue());
```

## Variables and Variable Resolvers

All of the previously-specified XPath expressions have been based on literal text. XPath also lets you specify variables to parameterize these expressions in a similar manner to using variables with SQL prepared statements.

A variable appears in an expression by prefixing its name (which may or may not have a namespace prefix) with a \$. For example, `/a/b[@c = $d]/text()` is an XPath expression that selects all `a` elements of the root node, and all of `a`'s `b` elements that have `c` attributes containing the value identified by variable `$d`, and returns the text of these `b` elements. This expression corresponds to Listing 15-24's XML document.

*Listing 15-24. A Simple XML Document for Demonstrating an XPath Variable*

```
<?xml version="1.0"?>
<a>
  <b c="x">b1</b>
  <b>b2</b>
  <b c="y">b3</b>
  <b>b4</b>
  <b c="x">b5</b>
</a>
```

To specify variables whose values are obtained during expression evaluation, you must register a variable resolver with your XPath object. A *variable resolver* is an instance of a class that implements the `XPathVariableResolver` interface in terms of its `Object resolveVariable(QName variableName)` method, and which tells the evaluator about the variable (or variables).

The `variableName` parameter contains the qualified name of a variable's name. (Remember that a variable name may be prefixed with a namespace prefix.) This method verifies that the qualified name appropriately names the variable and then returns its value.

After creating the variable resolver, you register it with the XPath instance by calling XPath's void `setXPathVariableResolver(XPathVariableResolver resolver)` method.

The following excerpt from Version 4 of this chapter's `XPathSearch` application (in this book's code archive) demonstrates all of these tasks in order to specify `$d` in XPath expression `/a/b[@c=$d]/text()`, which returns `b1` followed by `b5`. It assumes that Listing 15-24 is stored in a file named `example.xml`.

```

DocumentBuilderFactory dbf = DocumentBuilderFactory.newInstance();
DocumentBuilder db = dbf.newDocumentBuilder();
Document doc = db.parse("example.xml");
XPathFactory xpf = XPathFactory.newInstance();
XPath xp = xpf.newXPath();
XPathVariableResolver xpvr;
xpvr = new XPathVariableResolver()
    {
        @Override
        public Object resolveVariable(QName varname)
        {
            if (varname.getLocalPart().equals("d"))
                return "x";
            else
                return null;
        }
    };
xp.setXPathVariableResolver(xpvr);
XPathExpression xpe;
xpe = xp.compile("/a/b[@c = $d]/text()");
Object result = xpe.evaluate(doc, XPathConstants.NODESET);
NodeList nl = (NodeList) result;
for (int i = 0; i < nl.getLength(); i++)
    System.out.println(nl.item(i).getNodeValue());

```

**Caution** When you qualify a variable name with a namespace prefix (as in `$ns:d`), you must also register a namespace context to resolve the prefix.

## Transforming XML Documents with XSLT

*Extensible Stylesheet Language (XSL)* is a family of languages for transforming and formatting XML documents. *XSL Transformation (XSLT)* is the XSL language for transforming XML documents to other formats, such as HTML (for presenting an XML document's content via a web browser).

XSLT accomplishes its work by using XSLT processors and stylesheets. An *XSLT processor* is a software component that applies an *XSLT stylesheet* (an XML-based template consisting of content and transformation instructions) to an input document (without modifying the document), and copies the transformed result to a result tree, which can be output to a file or output stream, or even piped into another XSLT processor for additional transformations. Figure 15-3 illustrates the transformation process.

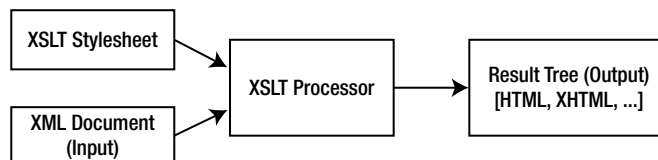

**Figure 15-3.** An XSLT processor transforms an XML input document into a result tree

The beauty of XSLT is that you don't need to develop custom software applications to perform the transformations. Instead, you simply create an XSLT stylesheet and input it along with the XML document needing to be transformed to an XSLT processor.

In this section, I first introduce you to Java's XSLT API. I then present two demonstrations of XSLT's usefulness.

### Exploring the XSLT API

Java implements XSLT through the types in the `javax.xml.transform`, `javax.xml.transform.dom`, `javax.xml.transform.sax`, and `javax.xml.transform.stream` packages. Oracle also provides a `javax.xml.transform.stax` package, which isn't supported by Android.

The `javax.xml.transform` package defines the generic APIs for processing transformation instructions and for performing a transformation from a source (where the XSLT processor's input originates) to a result (where the processor's output is sent). The remaining packages define the APIs for obtaining different kinds of sources and results.

The `javax.xml.transform.TransformerFactory` class is the starting point for working with XSLT. You instantiate `TransformerFactory` by calling one its `newInstance()` methods. The following example uses `TransformerFactory`'s `TransformerFactory.newInstance()` class method to create the factory:

```
TransformerFactory tf = TransformerFactory.newInstance();
```



Behind the scenes, `newInstance()` follows an ordered lookup procedure to identify the `TransformerFactory` implementation class to load. This procedure first examines the `javax.xml.transform.TransformerFactory` system property, and lastly chooses the Java platform's default `TransformerFactory` implementation class when no other class is found. If an implementation class isn't available (perhaps the class identified by the `javax.xml.transform.TransformerFactory` system property doesn't exist) or cannot be instantiated, `newInstance()` throws an instance of the `javax.xml.transform.TransformerFactoryConfigurationError` class. Otherwise, it instantiates the class and returns its instance.

After obtaining a `TransformerFactory` instance, you can call various configuration methods to configure the factory. For example, you could call `TransformerFactory`'s `void setFeature(String name, boolean value)` method to enable a feature (such as secure processing, to transform XML documents securely).

Following the factory's configuration, call one of its `newTransformer()` methods to create and return instances of the `javax.xml.transform.Transformer` class. The following example calls `Transformer` `newTransformer()` to accomplish this task:

```
Transformer t = tf.newTransformer();
```

The noargument `newTransformer()` method copies source input to the destination without making any changes. This kind of transformation is known as the *identity transformation*.

To change input, you need to specify a *stylesheet*, and you accomplish this task by calling the factory's `Transformer newTransformer(Source source)` method, where the `javax.xml.transform.Source` interface describes a source for the stylesheet. The following example demonstrates this task:

```
Transformer t = tf.newTransformer(new StreamSource(new FileReader("recipe.xml")));
```

This example creates a transformer that obtains a stylesheet from a file named `recipe.xml` via a `javax.xml.transform.stream.StreamSource` instance connected to a file reader. It's customary to use the `.xml` or `.xslt` extension to identify XSLT stylesheet files.

The `newTransformer()` methods throw `javax.xml.transform.TransformerConfigurationException` when they cannot return a `Transformer` instance that corresponds to the factory configuration.

After obtaining a `Transformer` instance, you can call its `void setOutputProperty(String name, String value)` method to influence a transformation. The `javax.xml.transform.OutputKeys` class declares constants for frequently used keys. For example, `OutputKeys.METHOD` is the key for specifying the method for outputting the result tree (as XML, HTML, plain text, or something else).

**Tip** To set multiple properties in a single method call, create a `java.util.Properties` object and pass this object as an argument to `Transformer`'s `void setOutputProperties(Properties prop)` method. Properties set by `setOutputProperty()` and `setOutputProperties()` override the stylesheet's `xsl:output` instruction settings.

Before you can perform a transformation, you need to obtain instances of classes that implement the `Source` and `javax.xml.transform.Result` interfaces. You then pass these instances to `Transformer`'s `void transform(Source xmlSource, Result outputTarget)` method, which throws an instance of the `javax.xml.transform.TransformerException` class when a problem arises during the transformation.

The following example shows you how to obtain a source and a result, and perform the transformation:

```
Source source = new DOMSource(doc);
Result result = new StreamResult(System.out);
t.transform(source, result);
```

The first line instantiates the `javax.xml.transform.dom.DOMSource` class, which acts as a holder for a DOM tree rooted in the `Document` object specified by `doc`. The second line instantiates the `javax.xml.transform.stream.StreamResult` class, which acts as a holder for the standard output stream, to which the transformed data items are sent. The third line reads data from the `Source` instance and outputs transformed data to the `Result` instance.

**Tip** Although Java's default transformers support the various `Source` and `Result` implementation classes located in the `javax.xml.transform.dom`, `javax.xml.transform.sax`, `javax.xml.transform.stax` (not in Android), and `javax.xml.transform.stream` packages, a nondefault transformer (perhaps specified via the `javax.xml.transform.TransformerFactory` system property) might be more limited. For this reason, each `Source` and `Result` implementation class declares a `FEATURE` string constant that can be passed to `TransformerFactory`'s `boolean getFeature(String name)` method. This method returns `true` when the `Source` or `Result` implementation class is supported. For example, `tf.getFeature(StreamSource.FEATURE)` returns `true` when stream sources are supported.

The `javax.xml.transform.sax.SAXTransformerFactory` class provides additional SAX-specific factory methods that you can use, but only when the `TransformerFactory` instance is also an instance of this class. To help you make the determination, `SAXTransformerFactory` also declares a `FEATURE` string constant that you can pass to `getFeature()`. For example, `tf.getFeature(SAXTransformerFactory.FEATURE)` returns `true` when the transformer factory referenced from `tf` is an instance of `SAXTransformerFactory`.

Most XML API interface instances and the factories that return them are not thread-safe. This situation also applies to transformers. Although you can reuse the same transformer multiple times on the same thread, you cannot access the transformer from multiple threads.

This problem can be solved for transformers by using instances of classes that implement the `javax.xml.transform.Templates` interface. The Java documentation for this interface has this to say: *Templates must be threadsafe for a given instance over multiple threads running concurrently, and they may be used multiple times in a given session.* Along with promoting thread safety, `Templates` instances can improve performance because they represent compiled XSLT stylesheets.

The following example shows how you might perform a transformation without a `Templates` object:

```
TransformerFactory tf = TransformerFactory.newInstance();
StreamSource ssStyleSheet = new StreamSource(new FileReader("recipe.xml"));
Transformer t = tf.newTransformer(ssStyleSheet);
t.transform(new DOMSource(doc), new StreamResult(System.out));
```

You cannot access `t`'s transformer from multiple threads. In contrast, the following example shows you how to construct a transformer from a `Templates` object so that it can be accessed from multiple threads:

```
TransformerFactory tf = TransformerFactory.newInstance();
StreamSource ssStyleSheet = new StreamSource(new FileReader("recipe.xml"));
Templates te = tf.newTemplates(ssStylesheet);
Transformer t = te.newTransformer();
t.transform(new DOMSource(doc), new StreamResult(System.out));
```

The differences are the call to `TransformerFactory`'s `Templates newTemplates(Source source)` method to create and return objects whose classes implement the `Templates` interface and the call to this interface's `Transformer newTransformer()` method to obtain the `Transformer` instance.

## Demonstrating the XSLT API

Listing 15-15 presents a `DOMDemo` application that creates a DOM document tree based on Listing 15-2's movie XML document. Unfortunately, you cannot use the DOM API to assign `ISO-8859-1` to the XML declaration's encoding attribute. Also, you cannot use DOM to output this tree to a file or other destination. However, you can overcome these problems with XSLT, as demonstrated in the following excerpt from Version 1 of this chapter's `XSLTDemo` application (in this book's code archive):

```
TransformerFactory tf = TransformerFactory.newInstance();
Transformer t = tf.newTransformer();
t.setOutputProperty(OutputKeys.METHOD, "xml");
t.setOutputProperty(OutputKeys.ENCODING, "ISO-8859-1");
t.setOutputProperty(OutputKeys.INDENT, "yes");
t.setOutputProperty("{http://xml.apache.org/xslt}indent-amount", "3");
Source source = new DOMSource(doc);
Result result = new StreamResult(System.out);
t.transform(source, result);
```

After creating a transformer factory and obtaining a transformer from this factory, four output properties are specified to influence the transformation. `OutputKeys.METHOD` specifies that the result tree will be written out as XML, `OutputKeys.ENCODING` specifies that `ISO-8859-1` will be the value of the XML declaration's encoding attribute, and `OutputKeys.INDENT` specifies that the transformer can output additional whitespace.

The additional whitespace is used to output the XML across multiple lines instead of on a single line. Because it would be nice to indicate the number of spaces for indenting lines of XML, and because this information cannot be specified via an `OutputKeys` property, the nonstandard `"{http://xml.apache.org/xslt}indent-amount"` property (property keys begin with brace-delimited URIs) is used to specify an appropriate value (such as 3 spaces). It's okay to specify this property in this example because Java's default XSLT implementation is based on Apache's XSLT implementation.

After setting properties, a source (the DOM document tree) and a result (the standard output stream) are obtained, and `transform()` is called to transform the source to the result.

Although this example shows you how to output a DOM tree and also how to specify an encoding value for the XML declaration of the resulting XML document, the example doesn't really demonstrate the power of XSLT because (apart from setting the encoding attribute value) it performs an identity transformation. A more interesting example would take advantage of a stylesheet.

Consider a scenario where you want to convert Listing 15-1's recipe document to an HTML document for presentation via a web browser. Listing 15-25 presents a stylesheet that a transformer can use to perform the conversion.

*Listing 15-25. An XSLT Stylesheet for Converting a Recipe Document to an HTML Document*

```
<?xml version="1.0"?>
<xsl:stylesheet version="1.0"
    xmlns:xsl="http://www.w3.org/1999/XSL/Transform">
<xsl:template match="/recipe">
<html>
  <head>
    <title>Recipes</title>
  </head>

  <body>
    <h2>
      <xsl:value-of select="normalize-space(title)"/>
    </h2>

    <h3>Ingredients</h3>

    <ul>
      <xsl:for-each select="ingredients/ingredient">
        <li>
          <xsl:value-of select="normalize-space(text())"/>
          <xsl:if test="@qty"> (<xsl:value-of select="@qty"/>)</xsl:if>
        </li>
      </xsl:for-each>
    </ul>

    <h3>Instructions</h3>

    <xsl:value-of select="normalize-space(instructions)"/>
  </body>
</html>
</xsl:template>
</xsl:stylesheet>
```

Listing 15-25 reveals that a stylesheet is an XML document. Its root element is `stylesheet`, which identifies the standard namespace for stylesheets. It's conventional to specify `xsl` as the namespace prefix for referring to XSLT instruction elements, although any prefix could be specified.

A stylesheet is based on template elements that control how an element and its content are converted. A template focuses on a single element that's identified via the `match` attribute. This attribute's value is an XPath location path expression, which matches all `recipe` child nodes of the root element node. Regarding Listing 15-1, only the single `recipe` root element will be matched and selected.

A template element can contain literal text and stylesheet instructions. For example, the `value-of` instruction in `<xsl:value-of select="normalize-space(title)"/>` specifies that the value of the `title` element (which is a child of the `recipe` context node) is to be retrieved and copied to the output. Because this text is surrounded by space and newline characters, XPath's `normalize-string()` function is called to remove this whitespace before the title is copied.

XSLT is a powerful declarative language that includes control flow instructions such as `for-each` and `if`. In the context of `<xsl:for-each select="ingredients/ingredient">`, `for-each` causes all of the `ingredient` child nodes of the `ingredients` node to be selected and processed one at a time. For each node, `<xsl:value-of select="normalize-space(text())"/>` is executed to copy the content of the `ingredient` node, normalized to remove whitespace. Also, the `if` instruction in `<xsl:if test="@qty">` (`<xsl:value-of select="@qty"/>`) determines whether or not the `ingredient` node has a `qty` attribute, and (if so) copies a space character followed by this attribute's value (surrounded by parentheses) to the output.

**Note** There's a lot more to XSLT than can be demonstrated in this short example. To learn more about XSLT, I recommend that you check out *Beginning XSLT 2.0 From Novice to Professional*, by Jeni Tennison and published by Apress ([www.apress.com/9781590593240](http://www.apress.com/9781590593240)). XSLT 2.0 is a superset of XSLT 1.0—Java 7 supports XSLT 1.0.

The following excerpt from Version 2 of this chapter's XSLTDemo application (in this book's code archive) shows how to write the Java code to process Listing 15-1 via Listing 15-24's stylesheet:

```
DocumentBuilderFactory dbf = DocumentBuilderFactory.newInstance();
DocumentBuilder db = dbf.newDocumentBuilder();
Document doc = db.parse("recipe.xml");
TransformerFactory tf = TransformerFactory.newInstance();
StreamSource ssStyleSheet;
ssStyleSheet = new StreamSource(new FileReader("recipe.xml"));
Transformer t = tf.newTransformer(ssStyleSheet);
t.setOutputProperty(OutputKeys.METHOD, "html");
t.setOutputProperty(OutputKeys.INDENT, "yes");
Source source = new DOMSource(doc);
Result result = new StreamResult(System.out);
t.transform(source, result);
```

This excerpt reveals that the output method is set to `html`, and it also reveals that the resulting HTML should be indented. However, the output is only partly indented, as shown in Listing 15-26.

*Listing 15-26. The HTML Equivalent of Listing 15-1's Recipe Document*

```
<html>
<head>
<META http-equiv="Content-Type" content="text/html; charset=UTF-8">
<title>Recipes</title>
</head>
<body>
<h2>Grilled Cheese Sandwich</h2>
<h3>Ingredients</h3>
<ul>
<li>bread slice (2)</li>
<li>cheese slice</li>
<li>margarine pat (2)</li>
</ul>
<h3>Instructions</h3>Place frying pan on element and select medium heat. For each bread slice, smear
one pat of margarine on one side of bread slice. Place cheese slice between bread slices with margarine-
smearred sides away from the cheese. Place sandwich in frying pan with one margarine-smearred side in
contact with pan. Fry for a couple of minutes and flip. Fry other side for a minute and serve.</body>
</html>
```

OutputKeys.INDENT and its "yes" value let you output the HTML across multiple lines as opposed to outputting the HTML on a single line. However, the XSLT processor performs no additional indentation, and it ignores attempts to specify the number of spaces to indent via code such as `t.setOutputProperty("{http://xml.apache.org/xslt}indent-amount", "3");`.

**Note** An XSLT processor outputs a `<META>` tag when `OutputKeys.METHOD` is set to "html".

## EXERCISES

The following exercises are designed to test your understanding of Chapter 15's content.

1. Define XML.
2. True or false: XML and HTML are descendants of SGML.
3. What is the XML declaration?
4. Identify the XML declaration's three attributes. Which attribute is nonoptional?
5. True or false: An element always consists of a start tag followed by content followed by an end tag.
6. Following the XML declaration, an XML document is anchored in what kind of element?
7. What is mixed content?
8. What is a character reference? Identify the two kinds of character references.
9. What is a CDATA section? Why would you use it?
10. Define namespace.
11. What is a namespace prefix?

12. True or false: A tag's attributes don't need to be prefixed when those attributes belong to the element.
13. What is a comment? Where can a comment appear in an XML document?
14. Define processing instruction.
15. Identify the rules that an XML document must follow to be considered well formed.
16. What does it mean for an XML document to be valid?
17. A parser that performs validation compares an XML document to a grammar document. Identify the two commonly used grammar languages.
18. What is the general syntax for declaring an element in a DTD?
19. Which grammar language lets you create complex types from simple types?
20. Define SAX.
21. How do you obtain a SAX 2-based parser?
22. What is the purpose of the `XMLReader` interface?
23. How do you tell a SAX parser to perform validation?
24. Identify the four kinds of SAX-oriented exceptions that can be thrown when working with SAX.
25. What interface does a handler class implement to respond to content-oriented events?
26. Identify the three other core interfaces that a handler class is likely to implement.
27. Define ignorable whitespace.
28. True or false: `void error(SAXParseException exception)` is called for all kinds of errors.
29. What is the purpose of the `org.xml.sax.helpers.DefaultHandler` class?
30. What is an entity? What is an entity resolver?
31. Define DOM.
32. True or false: Java 7 and newer versions of Android support DOM Levels 1 and 2 only.
33. Identify the 12 different DOM nodes.
34. How do you obtain a document builder?
35. How do you use a document builder to parse an XML document?
36. True or false: `Document` and all other `org.w3c.dom` interfaces that describe different kinds of nodes are subinterfaces of the `Node` interface.
37. How do you use a document builder to create a new XML document?
38. When creating a new XML document, can you use the DOM API to specify the XML declaration's encoding attribute?
39. What are a push parser and a pull parser?
40. True or false: Android uses Streaming API for XML (StAX) as its pull parser.
41. How do you obtain the pull parser?

42. How do you use the pull parser to parse an XML document?
43. Define XPath.
44. Where is XPath commonly used?
45. Identify the seven kinds of nodes that XPath recognizes.
46. True or false: XPath recognizes CDATA sections.
47. Describe what XPath provides for selecting nodes.
48. True or false: In a location path expression, you must prefix an attribute name with the @ symbol.
49. Identify the functions that XPath provides for selecting comment, text, and processing-instruction nodes.
50. What does XPath provide for selecting unknown nodes?
51. How do you perform multiple selections?
52. What is a predicate?
53. Identify the functions that XPath provides for working with nodesets.
54. Identify the three advanced features that XPath provides to overcome limitations with the XPath 1.0 language.
55. Define XSLT.
56. How does XSLT accomplish its work?
57. Create a `books.xml` document file with a `books` root element. The `books` element must contain one or more `book` elements, where a `book` element must contain one `title` element, one or more `author` elements, and one `publisher` element (in that order). Furthermore, the `book` element's `<book>` tag must contain `isbn` and `pubyear` attributes. Record `Advanced C++/James Coplien/Addison Wesley/0201548550/1992` in the first `book` element, `Beginning Groovy and Grails/Christopher M. Judd/Joseph Faisal Nusairat/James Shingler/Apress/9781430210450/2008` in the second `book` element, and `Effective Java/Joshua Bloch/Addison Wesley/0201310058/2001` in the third `book` element.
58. Modify `books.xml` to include an internal DTD that satisfies the previous exercise's requirements. Use Listing 15-10's `SAXDemo` application to validate `books.xml` against its DTD (`java SAXDemo books.xml -v`).
59. Create a `SAXSearch` application that searches `books.xml` for those `book` elements whose `publisher` child elements contain text that equals the application's single command-line `publisher` name argument. Once there is a match, output the `title` element's text followed by the `book` element's `isbn` attribute value. For example, `java SAXSearch Apress` should output `title = Beginning Groovy and Grails, isbn = 9781430210450`, whereas `java SAXSearch "Addison Wesley"` should output `title = Advanced C++, isbn = 0201548550` followed by `title = Effective Java, isbn = 0201310058` on separate lines. Nothing should output if the command-line `publisher` name argument doesn't match a `publisher` element's text.
60. Create a `DOMSearch` application that's the equivalent of the previous exercise's `SAXSearch` application.
61. Modify Listing 15-17's `contacts` document by changing `<name>John Doe</name>` to `<Name>John Doe</Name>`. Because you no longer see `John Doe` in the output when you run Listing 15-19's `XPathSearch` application (you only see `Bob Jones`), modify this application's location path expression so that you see `John Doe` followed by `Bob Jones`.



62. Create a `books.xml` stylesheet file and a `MakeHTML` application with a similar structure to the application that processes Listing 15-25's `recipe.xml` stylesheet. `MakeHTML` uses `books.xml` to convert Exercise 57's `books.xml` content to HTML. When viewed in a web browser, the HTML should result in a web page that's similar to the page shown in Figure 15-4.
- 

## Advanced C++

ISBN: 0201548550  
Publication Year: 1992

James O. Coplien

## Beginning Groovy and Grails

ISBN: 9781430210450  
Publication Year: 2008

Christopher M. Judd  
Joseph Faisal Nusairat  
James Shingler

## Effective Java

ISBN: 0201310058  
Publication Year: 2001

Joshua Bloch

*Figure 15-4. Exercise 57's `books.xml` content is presented via a web page*

## Summary

Applications often use XML documents to store and exchange data. Before you can understand these documents, you need to understand XML. This understanding requires knowledge of the XML declaration, elements and attributes, character references and CDATA sections, namespaces, and comments and processing instructions. It also involves learning what it means for a document to be well formed, and what it means for a document to be valid in terms of DTDs and XML Schema-based schemas.

You also need to learn how to process XML documents via the SAX, DOM, XMLPULL V1, XPath, and XSLT APIs. SAX is used to parse documents via a callback paradigm, DOM is used to parse documents into and create documents from node trees, XMLPULL V1 is used to parse documents in event-based contexts, XPath is used to search node trees in a more succinct manner than that offered by the DOM API, and XSLT (with help from XPath) is used to transform XML content to XML, HTML, or another format.

This chapter largely wraps up the coverage of Java APIs that are supported by Android. However, there are a few more APIs to consider. Chapter 16 presents these APIs and a few additional items.

# Focusing on Odds and Ends

I've covered much of what you need to know about Java to give you a solid foundation on which to build with Android app fundamentals. However, there still are a few topics that you should first understand. In this chapter, I introduce you to various language, API, and miscellaneous topics (such as design patterns and the Java Native Interface) that you'll find helpful in an Android context. I also present additional APIs (such as Preferences) that are not as useful for Android apps, but are sure to be useful for non-Android applications.

## Focusing on Additional Language Features

Apache Harmony ([http://en.wikipedia.org/wiki/Apache\\_Harmony](http://en.wikipedia.org/wiki/Apache_Harmony)) is the basis for the core of Android's standard class library, which is why Android doesn't support Java language features more recent than Java 5 and APIs more recent than Java 6. It's also why I haven't covered newer language features and APIs.

**Caution** Android doesn't support any version of Java (including the upcoming Java 8) beyond Java 6.

Java hasn't stopped evolving, and version 7 introduced several new language features that will be helpful to Android app developers. These features range from the small (adding underscores to integer literals, for example) to the more significant (such as automatic resource management). Unfortunately, attempts to build Android apps that leverage these features in their source codes fail. In 2012, I wrote a pair of articles for InformIT that show how to overcome various problems with JDK 7 when developing Android software:

- Overcoming Android's Problems with JDK 7, Part 1 ([www.informit.com/articles/article.aspx?p=1966023](http://www.informit.com/articles/article.aspx?p=1966023))
- Overcoming Android's Problems with JDK 7, Part 2 ([www.informit.com/articles/article.aspx?p=1966024](http://www.informit.com/articles/article.aspx?p=1966024))

Part 2 focuses on supporting Java 7 language features. Because you might want to follow that article's guidelines for supporting Java 7 language features in your Android apps, and because you are probably unfamiliar with Java 7's new language offerings, I briefly introduce you to several useful Java 7 language features in this section.

## Numeric Literal Enhancements

Java 7 introduced two enhancements to numeric literals: binary integer literals and underscores in numeric literals.

To express an integer literal in binary notation, the literal must be prefixed with `0b` or `0B` and continue with `0s` and `1s`. For example, `0b01111111` is the binary equivalent of decimal integer `127`.

To improve readability, you can insert underscores between an integer literal's digits, for example, `204_555_1212`. Although you can insert multiple successive underscores between digits (as in `0b1111__0000`), you cannot specify a leading underscore (as in `_123`) because the compiler would treat the literal as an identifier. Also, you cannot specify a trailing underscore (as in `123_`). This feature isn't confined to integer literals. You can also make floating-point literals easier to read by placing underscores between digits (`3.141_592_654`, for example).

## Switch-on-String

Another small but welcome language enhancement is switch-on-string. Starting with Java 7, you can pass a string expression to a switch statement's selector and specify string literals for this statement's various cases. For example, the following code fragment iterates over the array of command-line arguments passed to the `main()` method:

```
public static void main(String[] args)
{
    for (int i = 0; i < args.length; i++)
        switch (args[i])
        {
            case "-v":
            case "-V": System.out.println("version 1.0");
                       break;
            default  : showUsage();
        }
}
```

Each loop iteration uses `switch` to examine the current argument to determine if it's `-v` or `-V`. If so, a version number message is output; otherwise, the `showUsage()` method is invoked.

## Diamond Operator

Diamonds may be a girl's (and possibly a guy's) best friend, but the diamond operator (not a true operator) is bound to be a great friend of the developer. The diamond operator is an empty pair of angle brackets (<>) that you can specify as a shorthand for the actual type arguments when instantiating a generic type. For example, consider the following verbose code fragment:

```
Map<String, List<String>> countries = new HashMap<String, List<String>>();
```

You can use the diamond operator to replace this verbose code fragment with the following shorter code fragment that eliminates the duplicate type information:

```
Map<String, List<String>> countries = new HashMap<>();
```

## Multicatch

Java 7 introduced the ability to write a single catch block that catches more than one type of exception. This *multicatch* feature removes the need to catch overly broad exceptions (such as `catch (Exception ex)`) to avoid code duplication. Consider the following example where multicatch isn't used:

```
try
{
    // code that may throw IOException or SQLException
}
catch (IOException ioe)
{
    // code that logs and otherwise handles the exception
}
catch (SQLException sqle)
{
    // identical code to the previous catch block's code
}
```

To eliminate the duplicate code, Java 7 lets you specify multiple exception types in the catch block header. Each successive exception type is separated from its predecessor type by placing a vertical bar (|) between these types. For example, I can refactor the previous code fragment into the following more compact code fragment:

```
try
{
    // code that may throw IOException or SQLException
}
catch (IOException | SQLException iosqle)
{
    // code that logs and otherwise handles exception
}
```

When either `java.io.IOException` or `java.sql.SQLException` is thrown, this common catch block handles the exception.

**Note** When multiple exception types are listed in a catch block's header, the parameter is implicitly regarded as `final`.

## Automatic Resource Management

Listing 11-11's Copy application showed you how to use the `java.io.FileInputStream` and `java.io.FileOutputStream` classes to copy one file to another file. It also showed you how to close these streams and their underlying files properly, whether or not an exception was thrown. For convenience, I repeat Listing 11-11 here as Listing 16-1.

*Listing 16-1. Copying a Source File to a Destination File (Version 1)*

```
import java.io.FileInputStream;
import java.io.FileNotFoundException;
import java.io.FileOutputStream;
import java.io.IOException;

public class Copy
{
    public static void main(String[] args)
    {
        if (args.length != 2)
        {
            System.err.println("usage: java Copy srcfile dstfile");
            return;
        }
        FileInputStream fis = null;
        FileOutputStream fos = null;
        try
        {
            fis = new FileInputStream(args[0]);
            fos = new FileOutputStream(args[1]);
            int b; // I chose b instead of byte because byte is a reserved word.
            while ((b = fis.read()) != -1)
                fos.write(b);
        }
        catch (FileNotFoundException fnfe)
        {
            System.err.println(args[0] + " could not be opened for input, or " +
                args[1] + " could not be created for output");
        }
        catch (IOException ioe)
        {
            System.err.println("I/O error: " + ioe.getMessage());
        }
    }
}
```

```

finally
{
    if (fis != null)
        try
        {
            fis.close();
        }
        catch (IOException ioe)
        {
            assert false; // shouldn't happen in this context
        }

    if (fos != null)
        try
        {
            fos.close();
        }
        catch (IOException ioe)
        {
            assert false; // shouldn't happen in this context
        }
    }
}
}
}

```

Having to specify the boilerplate code that closes the input and output file streams is tedious and also prone to error. To overcome these problems, Java 7 introduced *automatic resource management (ARM)* to close open resources such as file streams automatically. It implemented ARM in the form of a new *try-with-resources* statement, which has the following syntax:

```

try (resource acquisition [; resource acquisition]*)
{
    // resource usage
}

```

According to this syntax, the `try` keyword is parameterized with a semicolon-separated list of resource-acquisition statements, where each statement acquires a resource. Each acquired resource can be accessed in the body of the `try` block, and it is automatically closed when execution leaves this body.

Unlike the regular `try` statement, `try-with-resources` doesn't require the `try` block to be followed by `catch` blocks and/or a `finally` block. However, these blocks can be specified.

Consider the following example:

```

try (FileInputStream fis = new FileInputStream(args[0]))
{
    // do something with the connection
}

```

This example creates a file input stream to the file identified by `args[0]` before entering the try block. This stream is closed when execution leaves this block, either normally or via a thrown exception.

Listing 16-2 shows you how to use try-with-resources to simplify Listing 16-1.

*Listing 16-2. Copying a Source File to a Destination File (Version 2)*

```
import java.io.FileInputStream;
import java.io.FileNotFoundException;
import java.io.FileOutputStream;
import java.io.IOException;

public class Copy
{
    public static void main(String[] args)
    {
        if (args.length != 2)
        {
            System.err.println("usage: java Copy srcfile dstfile");
            return;
        }
        try (FileInputStream fis = new FileInputStream(args[0]);
            FileOutputStream fos = new FileOutputStream(args[1]))
        {
            int b; // I chose b instead of byte because byte is a reserved word.
            while ((b = fis.read()) != -1)
                fos.write(b);
        }
        catch (FileNotFoundException fnfe)
        {
            System.err.println(args[0] + " could not be opened for input, or " +
                args[1] + " could not be created for output");
        }
        catch (IOException ioe)
        {
            System.err.println("I/O error: " + ioe.getMessage());
        }
    }
}
```

The file input and file output streams are closed when execution leaves the try block, either normally or when an exception is thrown.

Compile either Listing 16-1 or Listing 16-2 as follows:

```
javac Copy.java
```

Now execute the Copy application as follows:

```
java Copy Copy.java Copy.bak
```

If all goes well, you should observe a `Copy.bak` file whose contents are identical to `Copy.java`.

## Focusing on Classloaders

The virtual machine relies on *classloaders* to dynamically load compiled classes and other reference types (classes for short) from classfiles, Java Archive (JAR) files, URLs, and other sources into memory. Classloaders insulate the virtual machine from filesystems, networks, and so on.

In this section, I introduce you to classloaders by first presenting the various kinds of classloaders supported by Java. I then present the mechanics of loading a class. After demonstrating classloaders and revealing various difficulties with them, I close by discussing resources.

### Kinds of Classloaders

When the virtual machine starts running, three classloaders are available:

- *Bootstrap* (also known as *primordial* or *default*) uses the operating system file I/O mechanism to load classes from the core Java libraries (such as the `java.lang` and `java.io` packages found in `rt.jar`), and it is written in native code.
- *Extension* loads classes from the JAR files located in the extensions directories (such as `<JAVA_HOME>/lib/ext`). It's implemented by the `sun.misc.Launcher$ExtClassLoader` class (in `rt.jar`).
- *System* (also known as *application*) loads an application's classes and resources found on the classpath and is implemented by the `sun.misc.Launcher$AppClassLoader` class (in `rt.jar`).

Additionally, the standard class library provides the abstract `java.lang.ClassLoader` class as the ultimate root class for all classloaders (including extension and system) except for bootstrap.

`ClassLoader` is subclassed by the concrete `java.security.SecureClassLoader` class, which takes security information into account; and `SecureClassLoader` is subclassed by the concrete `java.net.URLClassLoader` class, which lets you load classes and resources from a search path of URLs referring to JAR files and directories. (`ExtClassLoader` and `AppClassLoader` extend `URLClassLoader`.)

**Note** Android supplies additional `DexClassLoader` and `PathClassLoader` classes that extend the common `BaseDexClassLoader` class, which itself extends `ClassLoader`. These three classes exist in the `dalvik.system` package.

Starting with Java 1.2, classloaders have a hierarchical relationship in which each classloader except for bootstrap has a parent classloader. The bootstrap classloader is the *root classloader* in much the same way as `java.lang.Object` is the root reference type.

Along with these kinds of classloaders, Java recognizes current and context classloaders.



The *current classloader* is the classloader that loads the class to which the currently executing method belongs, and it is implied by methods such as `java.lang.Class`'s `Class<?> forName(String className)` method. Behind the scenes, `forName()` relies on the current class loader to load the specified class.

When the current classloader (the bootstrap classloader is never current after loading the core Java libraries) is asked to load a class, it asks its parent to perform this task. When the parent cannot load the class, the parent asks its parent classloader to do so and this process continues on up the hierarchy. If none of these classloaders can load the class, the current classloader is given a chance. This behavior is known as *delegation*.

The *context classloader* (introduced in Java 1.2) is the classloader associated with the current thread. The current thread's context classloader is inherited from the thread's parent thread and defaults to the system classloader (which happens to be the classloader associated with the application's main—ultimate parent—thread). Also, the context classloader has a parent classloader and supports the same delegation model for class loading as previously described.

The `java.lang.Thread` class declares a `void setContextClassLoader(ClassLoader cl)` method that a parent thread invokes to specify a child thread's classloader before starting the child thread. A companion `ClassLoader getContextClassLoader()` method is also declared.

## Class-Loading Mechanics

Central to `ClassLoader` are its `Class<?> loadClass(String name)` and protected `Class<?> loadClass(String name, boolean resolve)` methods, which try to load the class with the specified name. They throw `java.lang.ClassNotFoundException` when the class cannot be found or return a `Class` object representing the loaded class. The former method invokes the latter method passing `false` to `resolve`. (In the Android reference implementation, `loadClass(String, boolean)`'s second parameter is ignored.)

**Note** The `java.lang.String` object passed to `name` must specify the class's binary name, which adheres to the convention that's specified in the *Java Language Specification* (<http://docs.oracle.com/javase/specs/>). Examples include `"java.lang.String"` and `"java.net.URLClassLoader$$$1"`.

The `loadClass(String name, boolean resolve)` method performs the following tasks.

1. It invokes `ClassLoader`'s protected final `Class<?> findLoadedClass(String name)` method to return the class with the given binary name when the calling classloader has been recorded by the virtual machine as an initiating loader of a class with that binary name. Otherwise, `null` is returned. This method returns the class from the calling classloader's class cache when the class was previously loaded (and is in this cache for performance reasons).
2. When `findLoadedClass()` returns `null`, `loadClass(String, boolean)` invokes `loadClass(String, boolean)` on the non-null parent classloader or invokes an internal method requesting that the bootstrap classloader handle this task.

3. When neither the parent nor any of its parents (including bootstrap) locates the class, `ClassNotFoundException` is thrown and the initial `loadClass(String, boolean)` method call invokes `ClassLoader`'s protected `Class<?> findClass(String name)` method to find and load the class.
4. The `findClass()` method locates the class or throws `ClassNotFoundException` when the class cannot be found; this exception is thrown out of `loadClass(String, boolean)` and `loadClass(String)`. (`ClassLoader`'s `findClass()` method always throws `ClassNotFoundException`.)
5. Assuming that the class is located, `findClass()` loads the class's compiled representation into an array of bytes. It then (ultimately) invokes one of `ClassLoader`'s `defineClass()` methods to convert these bytes into a `Class` object but only after `defineClass()` runs these bytes through the bytecode verifier (see Chapter 1) to ensure that they don't compromise virtual machine security.
6. Assuming that all is well, `findClass()` returns a `Class` object. When `true` is passed to `loadClass(String, boolean)`'s `resolve` parameter, `ClassLoader`'s protected final `void resolveClass(Class<?> c)` method is called to resolve the class. *Resolution* causes any other classes that are immediately referenced from the loaded class (such as a `static` variable of another class type) to be loaded by this classloader, classes immediately referenced from those classes to be loaded, and so on. (Classes used as instance variables, parameters, or local variables are not normally loaded at this time. They're loaded when actually referenced by the class.)

`findLoadedClass()` is declared `protected` so that it can be accessed by subclasses in different packages. This method is declared `final` so that it cannot be overridden. The same is true for `resolveClass()`.

**Tip** When you need your own classloader, you should first consider using `URLClassLoader`, which will save you a lot of work, and which leverages the security features provided by its `SecureClassLoader` parent. If you prefer to subclass `ClassLoader` directly, you'll minimally need to override `findClass()`.

## Playing with Classloaders

I've created a pair of applications to help you start to explore classloaders. Listing 16-3 presents the first application, which reveals that the main thread's context classloader is the system classloader.

*Listing 16-3. Proving that the Main Thread's Context Classloader is the System Classloader*

```
public class ClassLoaderDemo
{
    public static void main(String[] args)
    {
        System.out.println(Thread.currentThread().getContextClassLoader());
        System.out.println(ClassLoader.getSystemClassLoader());
    }
}
```

Listing 16-3's `main()` method first obtains the main thread's context classloader and outputs this classloader's name. This method then invokes `ClassLoader`'s `ClassLoader` `getSystemClassLoader()` class method, which returns a reference to the system classloader's `ClassLoader` object. The name of this classloader is then output.

Compile Listing 16-3 as follows:

```
javac ClassLoaderDemo.java
```

Run the application as follows:

```
java ClassLoaderDemo
```

You should observe output similar to that shown here:

---

```
sun.misc.Launcher$AppClassLoader@26e2e276
sun.misc.Launcher$AppClassLoader@26e2e276
```

---

My second application demonstrates `URLClassLoader`. It uses this classloader to load a class named `Hello` via a URL. This class's `Hello.class` classfile is located in directory `x`, which is a subdirectory of the current directory (the directory in which the virtual machine is launched via the `java` tool). Listing 16-4 presents `Hello.java`.

*Listing 16-4. A Simple Demonstration Class*

```
public class Hello
{
    static
    {
        System.out.println("Welcome to Hello");
    }

    static int x = 1;

    public static void main(String[] args)
    {
        System.out.println("Hello");
        System.out.println("Number of arguments = " + args.length);
        System.out.println("x = " + x);
    }
}
```

Hello must be declared public; otherwise, URLClassLoader outputs an error message about its not being able to access this class.

Assuming that Hello.java is stored in x, a subdirectory of the current directory, compile Listing 16-4, as follows:

```
javac x/Hello.java
```

Listing 16-5 presents an application that loads and runs this class.

*Listing 16-5. Attempting to Load Hello.class via a File-Based URL*

```
import java.lang.reflect.Method;

import java.net.MalformedURLException;
import java.net.URL;
import java.net.URLClassLoader;

public class ClassLoaderDemo
{
    final static String _URL_ = "file:/// " + System.getProperty("user.dir") + "/x/";

    public static void main(String[] args)
    {
        boolean init = true;
        if (args.length == 1 && args[0].equalsIgnoreCase("noinit"))
            init = false;
        try
        {
            URL[] urls = new URL[] { new URL(_URL_) };
            URLClassLoader urlc = new URLClassLoader(urls);
            Class<?> clazz = Class.forName("Hello", init, urlc);
            System.out.println(clazz.getClassLoader());
            run(clazz);
        }
        catch (ClassNotFoundException cnfe)
        {
            System.err.println("Class not found");
        }
        catch (MalformedURLException murle)
        {
            System.err.println("URL is malformed");
        }
    }

    static void run(Class<?> clazz)
    {
        try
        {
            Method main = clazz.getMethod("main", new Class[] { String[].class });
            Object[] args = new Object[] { new String[0] };
            main.invoke(null, args);
        }
    }
}
```

```

        catch (Exception e)
        {
            System.err.println(e.getMessage());
        }
    }
}

```

Listing 16-5's `main()` method first examines its array of command-line arguments for the presence of a `noinit` argument and resets the `init` variable (which is initially `true`) to `false` when this argument is specified. (I'll explain this variable's purpose shortly.)

`main()` next attempts to instantiate `URLClassLoader` by passing an array of one `java.net.URL` instance to this class's constructor. The string-based URL argument passed to `URL`'s constructor consists of the "file:/// " protocol prefix (to access the local filesystem), followed by `System.getProperty("user.dir")`'s result (the current working directory), followed by `"/x/"`. (The final `/"` is required; otherwise, `URLClassLoader` assumes that `x` is the name of a JAR file. Because this JAR file doesn't exist and obviously doesn't contain `Hello.class`, `ClassNotFoundException` is thrown.)

Assuming that `URLClassLoader` is successfully created, `main()` invokes `Class`'s `Class<?>.forName(String name, boolean initialize, ClassLoader loader)` method to try to load the class identified by name and using loader. Passing `true` to `initialize` causes the loaded class to be statically initialized. Otherwise, the loaded class isn't statically initialized. The `init` variable lets you explore both initialization scenarios.

The returned `Class` object's `ClassLoader getClassLoader()` method is invoked to return the `ClassLoader` instance used to load the class. This name is subsequently output.

`ClassLoaderDemo`'s `void run(Class<?> clazz)` class method is now called to instantiate the loaded class and invoke its `main()` method with help from the Reflection API (discussed in Chapter 8).

Assuming that `ClassLoaderDemo.java` is located with `x` in the current directory, compile this source file (`javac ClassLoaderDemo.java`) and run the application (`java ClassLoaderDemo`). The application responds by presenting the following output (except possibly for 56092666):

---

```

Welcome to Hello
java.net.URLClassLoader@56092666
Hello
Number of arguments = 0
x = 1

```

---

This output order proves that `Class.forName()` statically initialized `Hello` (`true` was passed to `initialize`) by invoking its `<clinit>()` virtual machine method (see Chapter 3).

Continue by running the application as follows:

```
java ClassLoaderDemo noinit
```

The application responds by presenting the following output (except possibly for 56092666):

---

```
java.net.URLClassLoader@56092666
Welcome to Hello
Hello
Number of arguments = 0
x = 1
```

---

This output order proves that `Class.forName()` didn't statically initialize `Hello`. However, this class is statically initialized just before `run()` launches its `main()` method.

Copy `Hello.class` into the same directory as `ClassLoaderDemo.class`, and then execute `java ClassLoader`. This time you'll observe the following output (except possibly for 26e2e276):

---

```
Welcome to Hello
sun.misc.Launcher$AppClassLoader@26e2e276
Hello
Number of arguments = 0
x = 1
```

---

The reason for this different output is that `URLClassLoader` delegates to its parent classloader, which happens to be the system classloader. The system classloader locates `Hello.class` in the current directory and causes `Class.forName()` to return this class's `Class` object.

## ClassLoader Difficulties

Context classloaders can be a source of difficulty as discussed in "Find a way out of the ClassLoader maze" ([www.javaworld.com/javaworld/javaqa/2003-06/01-qa-0606-load.html](http://www.javaworld.com/javaworld/javaqa/2003-06/01-qa-0606-load.html)), a JavaWorld article by Vladimir Roubtsov. I've created a simple example that demonstrates this difficulty.

My example is based on two versions of a class named `Version`. Listing 16-6 presents the first version's source code.

*Listing 16-6. A Simple Demonstration Class*

```
public class Version
{
    public static void main(String[] args)
    {
        System.out.println("Version 1");
    }
}
```

Assuming that `Version.java` is located in `x`, a subdirectory of the current directory, compile Listing 16-6 as follows:

```
javac x/Version.java
```

Create a `y` subdirectory of the current directory and copy a modified version of Listing 16-6 (replace `Version 1` with `Version 2`) to `y`. Then compile this source code as follows:

```
javac y/Version.java
```

Listing 16-7 presents a `ClassLoaderDemo` application that demonstrates a conflict between these versions.

*Listing 16-7. Entering Classloader Hell*

```
import java.lang.reflect.Method;

import java.net.MalformedURLException;
import java.net.URL;
import java.net.URLClassLoader;

public class ClassLoaderDemo
{
    final static String CD = System.getProperty("user.dir");
    final static String _URL1_ = "file:/// " + CD + "/x/";
    final static String _URL2_ = "file:/// " + CD + "/y/";

    public static void main(String[] args)
    {
        try
        {
            URL[] urls = new URL[] { new URL(_URL1_) };
            URLClassLoader urlc1 = new URLClassLoader(urls);
            Class<?> clazz1 = Class.forName("Version", true, urlc1);
            run(clazz1);
            urls = new URL[] { new URL(_URL2_) };
            URLClassLoader urlc2 = new URLClassLoader(urls);
            Class<?> clazz2 = Class.forName("Version", true, urlc2);
            run(clazz2);
            Thread.currentThread().setContextClassLoader(urlc1);
            run(Thread.currentThread().getContextClassLoader().loadClass("Version"));
            Thread.currentThread().
                setContextClassLoader(ClassLoader.getSystemClassLoader());
            run(Thread.currentThread().getContextClassLoader().loadClass("Version"));
        }
        catch (ClassNotFoundException cnfe)
        {
            System.err.println("Class not found");
        }
    }
}
```

```

        catch (MalformedURLException murle)
        {
            System.err.println("URL is malformed");
        }
    }

    static void run(Class<?> clazz)
    {
        try
        {
            Method main = clazz.getMethod("main", new Class[] { String[].class });
            Object[] args = new Object[] { new String[0] };
            main.invoke(null, args);
        }
        catch (Exception e)
        {
            System.err.println(e.getMessage());
        }
    }
}

```

Listing 16-7 loads both `Version` classes; each classloader caches its own version. It then sets the context classloader, first to the `URLClassLoader` instance and then to the system classloader. Each time, it subsequently calls `loadClass(String)`.

Compile Listing 16-7 (`javac ClassLoaderDemo.java`) and run the application (`java ClassLoaderDemo`). The following output is generated:

---

```

Version 1
Version 2
Version 1
Class not found

```

---

The system classloader doesn't include `Version` in its cache because it didn't load `Version`. As a result, `loadClass(String)` throws `ClassNotFoundException`.

Although this example is contrived, it illustrates problems that can occur when you're not aware of which classloader is the context classloader. You'll either observe a thrown `ClassNotFoundException` instance or you may end up with the wrong version of a class.

## Classloaders and Resources

Classloaders are typically used to load classes, but they can also load arbitrary resources (such as images) via `ClassLoader` methods such as `InputStream getResourceAsStream(String name)`. Although you could call these methods directly, it's common practice to work with `Class`'s `URL getResource(String name)` and `InputStream getResourceAsStream(String name)` methods instead. These methods differ in that `getResourceAsStream()` ultimately invokes `getResource()` and then invokes `URL`'s `InputStream openStream()` method on the resulting `URL` instance to return an input stream.



I've created an application that demonstrates Class's `getResourceAsStream()` method. Listing 16-8 presents its source code.

*Listing 16-8. Loading an Image Resource and Viewing a Prefix of Its Content*

```
import java.io.File;
import java.io.InputStream;
import java.io.IOException;

public class ClassLoaderDemo
{
    final static String IMAGE = "mars.jpg";

    public static void main(String[] args)
    {
        System.out.println(ClassLoaderDemo.class.getClassLoader());
        InputStream is = ClassLoaderDemo.class.getResourceAsStream(IMAGE);
        if (is == null)
        {
            System.err.printf("%s not found\n", IMAGE);
            return;
        }
        try
        {
            byte[] image = new byte[(int) new File(IMAGE).length()];
            int _byte, i = 0;
            while ((_byte = is.read()) != -1)
                image[i++] = (byte) _byte;
            for (i = 0; i < 16; i++)
                System.out.printf("%02X ", image[i]);
        }
        catch (IOException ioe)
        {
            System.err.println("I/O error: " + ioe.getMessage());
        }
    }
}
```

Listing 16-8 specifies expression `ClassLoaderDemo.class` to obtain the Class object returned from the classloader that loaded `ClassLoaderDemo.class`, and then invokes `getResourceAsStream(IMAGE)` on the returned Class object. This image needs to be located in the current directory.

Assuming that this image resource can be found (`getResourceAsStream()` doesn't return null), a byte array is allocated to hold the array and the image's bytes are read over the input stream and stored in the byte array. The first 16 bytes from this array are then sent to standard output.

Compile Listing 16-8 (`javac ClassLoaderDemo.java`) and run the application (`java ClassLoaderDemo`). You should observe the following output:

---

```
sun.misc.Launcher$AppClassLoader@26e2e276
FF D8 FF E0 00 10 4A 46 49 46 00 01 02 01 00 48
```

---

It's common to store resources in JAR files and then access them via `getResourceAsStream()`. For example, execute the following command (which assumes that the current directory contains `mars.jpg`) to create an `image.jar` file containing `mars.jpg`:

```
jar cf image.jar mars.jpg
```

After creating this file, erase `mars.jpg` from the current directory. Continue by executing the following command:

```
java -cp image.jar;. ClassLoaderDemo
```

Note that `image.jar` and the current directory must be on the classpath so that the system classloader can load classes and resources as necessary. This time, you'll observe a thrown `java.lang.ArrayIndexOutOfBoundsException` instance. This exception occurs because you're trying to populate a zero-length byte array. This array has zero length because `(int) new File(IMAGE).length()` returns 0 (`mars.jpg` cannot be found—you just erased it).

One way to solve this problem is to remove `(int) new File(IMAGE).length()` and hardcode the image's length instead. Although this refactoring works, it isn't a good idea because it can result in a runtime exception should the size of the image change.

A better solution is to calculate the length of the file by reading the input stream and then obtain a new input stream for reading file content. Listing 16-9 demonstrates this technique.

*Listing 16-9. Loading an Image Resource in a More Robust Manner and Viewing a Prefix of Its Content*

```
import java.io.File;
import java.io.InputStream;
import java.io.IOException;

public class ClassLoaderDemo
{
    final static String IMAGE = "mars.jpg";

    public static void main(String[] args)
    {
        System.out.println(ClassLoaderDemo.class.getClassLoader());
        InputStream is = ClassLoaderDemo.class.getResourceAsStream(IMAGE);
        if (is == null)
        {
            System.err.printf("%s not found%n", IMAGE);
            return;
        }
        try
        {
            byte[] image = new byte[getLength(is)];
            is = ClassLoaderDemo.class.getResourceAsStream(IMAGE);
            int _byte, i = 0;
```

```

        while ((_byte = is.read()) != -1)
            image[i++] = (byte) _byte;
        for (i = 0; i < 16; i++)
            System.out.printf("%02X ", image[i]);
    }
    catch (IOException ioe)
    {
        System.err.println("I/O error: " + ioe.getMessage());
    }
}

static int getLength(InputStream is) throws IOException
{
    byte[] buffer = new byte[1024];
    int length = 0;
    int bytesRead;
    while ((bytesRead = is.read(buffer)) > 0)
        length += bytesRead;
    return length;
}
}

```

Listing 16-9 introduces a `getLength(InputStream)` class method that reads the contents of the input stream into a fixed-size buffer in multiple steps. The number of bytes read is accumulated in a `length` variable whose value is returned from the method.

This time, `ClassLoaderDemo` will successfully read the contents of the image whether or not the image is stored in a JAR file.

## Focusing on Console

You're writing a console-based application that runs on the server. This application needs to prompt the user for a username and a password before granting access. Obviously, you don't want the password to be echoed to the console (such as a command window).

Before Java 6, you had almost no way to accomplish this task without resorting to the Java Native Interface (discussed later). Although `java.awt.TextField` provides a `void setEchoChar(char c)` method for this purpose, this method is only appropriate for GUI-based/non-Android applications.

**Note** AWT stands for *Abstract Window Toolkit*, a windowing toolkit that makes it possible to create crude user interfaces consisting of windows, buttons, text fields (via the `TextField` class), and so on. The AWT was released as part of Java 1.0 in 1995, and it continues to be part of Java's standard class library. The AWT isn't supported by Android.

Java 6 responded to this need by introducing the `java.io.Console` class. This class declares methods that access the platform's character-based console device but only when that device is associated with the current virtual machine.

**Note** Whether or not a virtual machine has a console is dependent upon the underlying platform and also upon the manner in which the virtual machine is invoked. When the virtual machine is started from an interactive command line without redirecting the standard input and output streams, its console will exist and (typically) will be connected to the keyboard and display from which the virtual machine was launched. When the virtual machine is started automatically (such as by a background job scheduler), it usually won't have a console.

To determine if a console is available, call the `java.lang.System` class's `Console console()` class method, as follows:

```
Console console = System.console();
if (console == null)
{
    System.err.println("no console device is present");
    return;
}
```

This method returns a `Console` reference when a console is present; otherwise, it returns `null`. After verifying that `null` wasn't returned, you can use the reference to call `Console`'s methods (see Table 16-1).

**Table 16-1. Console Methods**

Method	Description
<code>void flush()</code>	Flushes the console, immediately writing any buffered output.
<code>Console format(String fmt, Object... args)</code>	Writes a formatted string to the console's output stream. The <code>Console</code> reference is returned so that you can chain method calls together (for convenience). This method throws <code>java.util.IllegalFormatException</code> when the format string contains illegal syntax. (I discussed format strings in the context of the <code>java.util.Formatter</code> class in Chapter 13.)
<code>Console printf(String format, Object... args)</code>	An alias for <code>format()</code> .
<code>Reader reader()</code>	Returns the <code>java.io.Reader</code> instance associated with the console. This instance can be passed to a <code>java.util.Scanner</code> constructor for sophisticated scanning/parsing. (I discussed <code>Scanner</code> in Chapter 13.)
<code>String readLine()</code>	Reads a single line of text from the console's input stream. The line (minus line-termination characters) is returned in a <code>String</code> object. This method returns <code>null</code> when the end of the stream is reached. It throws <code>java.io.IOException</code> when an I/O error occurs.

(continued)

Table 16-1. (continued)

Method	Description
<code>String readLine(String fmt, Object... args)</code>	Writes a formatted prompt string to the console's output stream and then reads a single line of text from its input stream. The line (minus line-termination characters) is returned in a <code>String</code> object. This method returns null when the end of the stream has been reached. It throws <code>IllegalFormatException</code> when the format string contains illegal syntax and <code>IOException</code> when an I/O error occurs.
<code>char[] readPassword()</code>	Reads a password or passphrase from the console's input stream with echoing disabled. The password/passphrase (minus line-termination characters) is returned in a <code>char</code> array. This method returns null when the end of the stream has been reached. It throws <code>IOException</code> when an I/O error occurs.
<code>char[] readPassword(String fmt, Object... args)</code>	Writes a formatted prompt string to the console's output stream and then reads a password/passphrase from its input stream with echoing disabled. The password/passphrase (minus line-termination characters) is returned in a <code>char</code> array. This method returns null when the end of the stream has been reached. It throws <code>IllegalFormatException</code> when the format string contains illegal syntax and <code>IOException</code> when an I/O error occurs.
<code>PrintWriter writer()</code>	Returns the unique <code>java.io.PrintWriter</code> instance associated with this console.

I've created a Login application that invokes Console methods to obtain a username and a password. Listing 16-10 presents Login's source code.

Listing 16-10. Simulating a Username/Password Login Operation

```
import java.io.Console;
import java.io.IOException;

public class Login
{
    public static void main(String[] args)
    {
        Console console = System.console();
        if (console == null)
        {
            System.err.println("no console device is present");
            return;
        }
        try
        {
            String username = console.readLine("Username:");
            char[] pwd = console.readPassword("Password:");
            // Do something useful with the username and password. For something
            // to do, this application just prints out these values.
            System.out.println("Username = " + username);
            System.out.println("Password = " + new String(pwd));
        }
    }
}
```

```

    // Prepare username String for garbage collection. More importantly,
    // destroy the password.
    username = "";
    for (int i = 0; i < pwd.length; i++)
        pwd[i] = 0;
    }
    catch (IOException ioe)
    {
        console.printf("I/O error: %s\n", ioe.getMessage());
    }
}
}
}

```

Compile Listing 16-10 as follows:

```
javac Login.java
```

Run this application as follows:

```
java Login
```

The application first prompts you to enter a username that's displayed and then prompts for a password that isn't displayed. After entering the password, messages identifying the username and password are written to standard output.

**Note** After obtaining and (presumably) doing something useful with the entered username and password, it's important to get rid of these items for security reasons. Most importantly, you'll want to remove the password by zeroing out the char array.

## Focusing on Design Patterns

Designing significant applications is often difficult and prone to error. For example, a poorly designed application might suffer from the fragile base class problem that I discussed in Chapter 4. Over the years, developers have encountered various design problems and have devised clever solutions. These problems and their solutions have been catalogued to help other developers detect them and avoid reinventing solutions. These catalogued entities are known as design patterns.

A *design pattern* is a catalogued problem/solution entity that consists of four components:

- **Name:** Each design pattern has a name that describes the pattern and provides a vocabulary for discussing it with other developers.
- **Problem:** Each design pattern clearly states the problem that it solves and the context in which the problem occurs. It tells you when to apply the design pattern.

- *Solution*: Each design pattern identifies the classes and objects along with their relationships and other factors that solve the problem.
- *Consequences*: Choosing one design pattern over another pattern involves trade-offs that can impact your application's flexibility and future maintenance.

Perhaps the most famous design patterns catalog is *Design Patterns: Elements of Reusable Object-Oriented Software* by Erich Gamma, Richard Helm, Ralph Johnson, and John Vlissides (Addison-Wesley, 1995; ISBN: 0201633612). This book presents 23 design patterns, such as the Decorator pattern that I briefly mentioned in Chapter 4 for solving the fragile base class problem. It uses the C++ programming language to codify these patterns.

To give you an appetite for design patterns, which you might find helpful when designing Android apps, I present the Strategy pattern in a Java context.

## Understanding Strategy

The *Strategy pattern* lets you define a family of algorithms (such as sorting algorithms), encapsulate each algorithm in its own class, and make these algorithms interchangeable. Each encapsulated algorithm is known as a *strategy*. At runtime, your application chooses the appropriate algorithm that meets its requirements.

Unlike Decorator, which lets you change an object's appearance, Strategy lets you change an object's behaviors. You move conditional branches into their own strategy classes to avoid multiple conditional statements. These classes often implement a Java interface or derive from an abstract superclass, which your application references and uses to interact with a specific strategy.

There are three participants in the Strategy pattern:

- *Strategy*: A common interface to all supported algorithms.
- *ConcreteStrategy*: An implementation of the Strategy interface for a specific algorithm. Multiple ConcreteStrategy participants are common.
- *Context*: The context in which the concrete strategy is invoked.

## Implementing Strategy

Consider an abstract implementation consisting of Strategy, ConcreteStrategy $x$  ( $x$  is an integer that uniquely identifies a strategy), and Context types. Listing 16-11 presents Strategy.

*Listing 16-11. Strategy Presents a Common Method That Each Strategy Implementation Class Must Implement*

```
public interface Strategy
{
    public void execute(String msg);
}
```

Listing 16-11's Strategy interface offers an abstract execute() method that must be implemented by each class that implements this interface. This method executes a strategy algorithm.

In this example, `execute()` returns nothing, although it could be declared to return a value of a specific type. Also, `execute()` declares a single `String` parameter. `execute()`'s return type and parameter list depend upon the family of algorithms that are implemented.

You typically choose a Java interface to implement the common strategy interface. However, you can also use an abstract class, especially when you need to store data that's common to all concrete strategies, for example, the width in which to align text for left-alignment, right-alignment, and justify text-alignment strategies.

Listing 16-12 presents a concrete strategy implementation.

*Listing 16-12. ConcreteStrategy1 Provides an Implementation of the Strategy Interface*

```
public class ConcreteStrategy1 implements Strategy
{
    @Override
    public void execute(String msg)
    {
        System.out.printf("executing strategy #1: msg = %s\n", msg);
    }
}
```

Listing 16-13 presents a second concrete strategy implementation.

*Listing 16-13. ConcreteStrategy2 Provides a Second Implementation of the Strategy Interface*

```
public class ConcreteStrategy2 implements Strategy
{
    @Override
    public void execute(String msg)
    {
        for (int i = 0; i < 3; i++)
            System.out.printf("executing strategy #2: msg = %s\n", msg);
    }
}
```

In each of Listings 16-12 and 16-13, you can think of `execute()` as performing a more useful task such as executing a specific sorting algorithm (Quick Sort or Bubble Sort, for example).

Listing 16-14 presents a Context class for invoking concrete strategies.

*Listing 16-14. Context Provides a Framework for Invoking Concrete Strategy Implementations*

```
public class Context
{
    private Strategy strategy;

    public Context(Strategy strategy)
    {
        setStrategy(strategy);
    }
}
```



```
public void executeStrategy(String msg)
{
    strategy.execute(msg);
}

public void setStrategy(Strategy strategy)
{
    this.strategy = strategy;
}
}
```

Listing 16-14's Context class stores a concrete strategy when created, provides a method to subsequently change the strategy, and provides another method to execute the current strategy.

Finally, Listing 16-15 presents a StrategyDemo application that demonstrates the strategy pattern via these types.

*Listing 16-15. StrategyDemo Reveals the Strategy Pattern's Plug and Play Nature*

```
public class StrategyDemo
{
    public static void main(String[] args)
    {
        Context context = new Context(new ConcreteStrategy1());
        context.executeStrategy("Hello");
        context.setStrategy(new ConcreteStrategy2());
        context.executeStrategy("World");
    }
}
```

Context is instantiated and its instance is configured to the first concrete strategy. The Context object then executes this strategy with a Hello text message. Next, the Context object is reconfigured with the second concrete strategy and then executes this strategy with a World text message.

Compile Listing 16-15 as follows:

```
javac StrategyDemo.java
```

Assuming that all source files are located in the same current directory, compilation should succeed.

Execute StrategyDemo as follows:

```
java StrategyDemo
```

You should observe the following output:

---

```
executing strategy #1: msg = Hello
executing strategy #2: msg = World
executing strategy #2: msg = World
executing strategy #2: msg = World
```

---

**Note** Check out Pankaj Kumar's "Strategy Design Pattern in Java – Example Tutorial" blog post ([www.javacodegeeks.com/2013/08/strategy-design-pattern-in-java-example-tutorial.html](http://www.javacodegeeks.com/2013/08/strategy-design-pattern-in-java-example-tutorial.html)) for a more useful shopping cart example of the strategy design pattern.

## Focusing on Double Brace Initialization

While discussing anonymous classes in Chapter 5, I stated the following:

*Although an anonymous class doesn't have a constructor, you can provide an instance initializer to handle complex initialization. For example, `new Office() {{addEmployee(new Employee("John Doe"));}}`; instantiates an anonymous subclass of `Office` and adds one `Employee` object to this instance by calling `Office`'s `addEmployee()` method.*

The previous code fragment can be expressed less compactly but perhaps more clearly as follows:

```
new Office()
{
    {
        addEmployee(new Employee("John Doe"));
    }
};
```

The `add-employee` code within the instance initializer is executed when an object is created from an anonymous subclass of the `Office` class.

This example demonstrates what is commonly referred to as *double brace initialization* ([www.c2.com/cgi/wiki?DoubleBraceInitialization](http://www.c2.com/cgi/wiki?DoubleBraceInitialization)). Although convenient, double brace initialization has a couple of drawbacks that you need to understand.

One drawback is a bloated number of classfiles (<http://stackoverflow.com/questions/924285/efficiency-of-java-double-brace-initialization>). Anonymous classes contribute to the number of classfiles comprising an application, which can greatly increase its size. This increased size can be especially problematic when installing and running Android apps on devices with limited storage/memory space.

A second drawback is that you are unable to use Java 7's diamond operator (<http://java.dzone.com/articles/double-brace-initialization>), which you might want to use after reading my article (mentioned earlier in this chapter) on supporting Java 7 language features. You cannot specify the diamond operator because the compiler cannot infer type arguments. For example, consider the following code fragment:

```
Map<String, String> capitals = new HashMap<>()
    {{
        put("Canada", "Ottawa");
        put("England", "London");
        put("France", "Paris");
    }};
```

The compiler reports an error when it encounters the diamond operator. The corrected code fragment, which specifies the type arguments when instantiating `HashMap`, appears below:

```
Map<String, String> capitals = new HashMap<String, String>()
    {{
        put("Canada", "Ottawa");
        put("England", "London");
        put("France", "Paris");
    }};
```

## Focusing on Fluent Interfaces

While discussing methods in Chapter 3, I referred to instance method call chaining in which instance method calls are chained together as in `new SavingsAccount().deposit(1000).printBalance();`.

Instance method call chaining is more compactly known as *method chaining*. Each method call in the chain returns an object, allowing the calls to be chained together in a single statement. Chaining is syntactic sugar that eliminates the need for intermediate variables.

Method chaining is used in the construction of *fluent interfaces*, which are implementations of object-oriented APIs that provide for more readable code.

According to Wikipedia's "Fluent interface" topic ([http://en.wikipedia.org/wiki/Fluent\\_interface](http://en.wikipedia.org/wiki/Fluent_interface)), a fluent interface is normally implemented via method chaining to relay the instruction context of a subsequent method call. Furthermore, the context is defined through the return value of a called method, the context is self-referential in that the new context is equivalent to the last context, and the context is terminated through the return of a void context.

The Java Object Oriented Querying library (commonly known as jOOQ) is a light database-mapping software library that offers a well-known example of a fluent interface. For example, consider the following SQL query for selecting authors with sold-out books:

```
SELECT * FROM AUTHOR a
  WHERE EXISTS (SELECT 1
    FROM BOOK
     WHERE BOOK.STATUS = 'SOLD OUT'
     AND BOOK.AUTHOR_ID = a.ID);
```

This query can be expressed compactly in Java via the jOOQ fluent interface:

```
create.selectFrom(AUTHOR.as("a"))
    .where(exists(selectOne()
    .from(BOOK)
    .where(BOOK.STATUS.equal(BOOK_STATUS.SOLD_OUT))
    .and(BOOK.AUTHOR_ID.equal(a.ID))));
```

Notice that method calls typically have short names (such as `where`, `from`, and `and`). Also, method chaining is used to connect these method calls together, the return value from each method call returns the same self-referential context, and the context returned from `create` is most likely void.

If you're interested in creating your own fluent interfaces, I invite you to check out Neal Ford's "Evolutionary architecture and emergent design: Fluent interfaces" article ([www.ibm.com/developerworks/java/library/j-eaed14/index.html](http://www.ibm.com/developerworks/java/library/j-eaed14/index.html)).

**Note** Perhaps you're familiar with the concept of a builder and want to know how it compares to a fluent interface. For the details, check out [stackoverflow.com's "What is the difference between fluent interface and builder pattern?"](http://stackoverflow.com/questions/17937755/what-is-the-difference-between-fluent-interface-and-builder-pattern) topic (<http://stackoverflow.com/questions/17937755/what-is-the-difference-between-fluent-interface-and-builder-pattern>).

## Focusing on Immutability

Earlier in this book, I introduced you to the `final` keyword. To recap, you use `final` in the following contexts:

- Declare a true constant in a class. Example: `final static PI = 3.14159;`
- Declare a blank final in a class. Unlike a true constant, a blank final is only a constant within the context of an object. Example: `final int ID;`
- Prevent a class from being subclassed to avoid the fragile base class problem. Example: `final class SavingsAccount`
- Prevent a method from being overridden for security or other reasons. Example: `final void deposit(BigDecimal amount)`
- Access a local variable or parameter from within an anonymous or local class. Example: `public static void main(final String[] args)`

**Tip** Some developers prefer to declare all local and parameter variables that will never change after being initialized `final` to prevent bugs that arise from subsequently assigning values to these variables by accident. The compiler would detect such assignment attempts and report errors.

The `final` keyword plays a large role in the creation of *immutable classes*, which are classes whose instances cannot be modified. The `String` and `java.lang.Boolean` classes are examples.

Immutable classes offer several advantages, which is why you might consider designing most of your classes to be immutable:

- Objects created from immutable classes are thread-safe and there are no synchronization issues. Because they cannot be corrupted when used by multiple threads, you can freely share them among threads. To encourage reuse of these shared objects (and to reduce garbage collection), you often find, in various immutable classes, precreated instances of common values that are expressed as `public static final` constants. For example, `Boolean` declares `TRUE` and `FALSE` `Boolean` constants that represent the common true and false values.

- You can share the internals of an immutable class to reduce memory usage and improve performance. For example, the `String` class provides an internal array of characters named `value`. When you invoke a `substring()` method, a new `String` object is created that references the same `value` array as the `String` object on which this method was called. However, a different offset and length are passed to the object so that only the portion of the parent string delimited by the offset and length is observed as the substring. The result is a memory savings and reduced copying to improve performance.
- Immutable classes support *failure atomicity* (a term coined by Joshua Bloch in his *Effective Java* books), which means that, after throwing an exception, an object is still in a well-defined and usable state, even when the exception occurred during an operation.
- Immutable classes are excellent building blocks for more complex classes. The fact that immutable objects are thread-safe makes it easier to design complex classes that maintain their invariants.
- Immutable objects make good `java.util.Map` keys and `java.util.Set` elements because objects must not change state while in a collection.

Several guidelines must be followed to ensure that a class is immutable:

- Don't include setter or other mutator methods in the class design. Instances of the class must never be modified following initialization.
- Prevent methods from being overridden. Doing so prevents a subclass from overriding a method and attempting to use it to break immutability. You can easily accomplish this task by declaring the class `final`.
- Declare all fields `final`. You should also declare those fields that are part of the implementation `private` so that you are free to change the implementation without breaking clients.
- Prevent the class from exposing any mutable state. Clients should never be able to access fields that reference mutable objects. Also, never directly assign a client-provided object reference to a field or return an object reference from a getter or other accessor method. Instead, make defensive copies in constructors, accessor methods, and the `readObject()` method (when using serialization).

Making a defensive copy isn't a difficult task. For example, the following code fragment shows you how to make a defensive copy of a mutable and fictitious `Date` object:

```
Date getHireDate()
{
    return new Date(hireDate.getValue());
}
```

This code fragment assumes a private `hireDate` field that stores the date on which an employee was hired. This field is of type `Date`, which provides a `getValue()` method for returning the date's value. Additional particulars of the `Date` class aren't important. Instead, note that you are constructing a new `Date` object that is equivalent to the `Date` object referenced from the `hireDate` field. The internal `Date` object cannot be modified by external code that invokes `getHireDate()`.

You would also make defensive copies of arrays. For example, suppose that you have an internal `grades` array of type `int[]` and you are declaring a `getGrades()` method to return this array. The following code fragment shows you how to create and return a copy of this array so that the original array cannot be modified by external code:

```
int[] getGrades()
{
    int[] copy = new int[grades.length];
    System.arraycopy(grades, 0, copy, 0, copy.length);
    return copy;
}
```

The `System.arraycopy()` method is used to quickly copy the original `grades` array to the new `copy` array.

If your array contains references to mutable objects, it's not enough to make a copy of the array: you also need to make a copy of each array element, as follows:

```
Date[] getDates()
{
    Date[] copy = new Date[dates.length];
    System.arraycopy(dates, 0, copy, 0, copy.length);
    for (int i = 0; i < dates.length; i++)
        copy[i] = new Date(dates[i].getValue());
    return copy;
}
```

Listing 16-16 presents an example of an immutable `Recipe` class that follows the previous guidelines. For brevity, I've omitted import statements along with the `Ingredient` and `Step` classes.

**Listing 16-16. An Immutable Recipe Class**

```
public final class Recipe
{
    private String name;
    private List<Ingredient> ingredients;
    private List<Step> steps;

    public Recipe(String name, Ingredient[] ingredients, Step[] steps)
    {
        this.name = name;
        ingredients = new ArrayList<Ingredient>();
        for (Ingredient ingredient: ingredients)
            ingredients.add(ingredient);
        steps = new ArrayList<Step>();
        for (Step step: steps)
            steps.add(step);
    }

    public List<Ingredient> getIngredients()
    {
        return new ArrayList<Ingredient>(ingredients);
    }
}
```

```
public String getName()
{
    return name;
}

public List<Step> getSteps()
{
    return new ArrayList<Step>(steps);
}
}
```

Notice that the constructor and `getIngredients()/getSteps()` getters make defensive copies of the `ingredients/steps` arrays and array lists, respectively. In contrast, it isn't necessary to make a defensive copy of the `name` parameter in the constructor and `name` field in the `getName()` getter because `name` is of type `String`, which is immutable.

**Note** Before you can use `Recipe` in a `HashMap` context, you also have to override the `equals()` and `hashCode()` methods.

## Focusing on Internationalization

We tend to write software that reflects our cultural backgrounds. For example, a Spanish developer's application might present Spanish text, an Arabic developer's application might present a Hijri (Islamic) calendar, and a Japanese developer's application might display its currencies using the Japanese Yen currency symbol. Because cultural issues restrict the size of an application's audience, you might consider internationalizing your applications to reach a larger audience (and make more money).

*Internationalization* is the process of creating an application that automatically adapts to its current user's culture (without recompilation) so that the user can read text in the user's language and otherwise interact with the application without observing cultural issues. Java simplifies internationalization by supporting *Unicode* (a universal character set that encodes the various symbols making up the world's written languages) via the `char` keyword (see Chapter 2) and the `java.lang.Character` class (see Chapter 7), and by offering the APIs discussed in this section.

Related to internationalization is the concept of *localization*, which is the adaptation of internationalized software to support a new culture by adding culture-specific elements (such as text strings that have been translated to the culture). Java already provides much of this support via various APIs, and it also lets you extend its support via locale-sensitive services, which are not discussed for brevity. Because Android differs somewhat where localization is concerned, I'll have more to say about this topic in Appendix C.

## Locales

The `java.util.Locale` class is the centerpiece of the various Internationalization APIs. Instances of this class represent *locales*, which are geographical, political, or cultural regions.

`Locale` declares constants (such as `CANADA`) that describe some common locales. This class also declares three constructors for initializing `Locale` objects in case you cannot find an appropriate `Locale` constant for a specific locale:

- `Locale(String language)` initializes a `Locale` instance to a language code, for example, "fr" for French.
- `Locale(String language, String country)` initializes a `Locale` instance to a language code and a country code, for example, "en" for English and "US" for United States.
- `Locale(String language, String country, String variant)` initializes a `Locale` instance to a language code, a country code, and a vendor- or browser-specific variant code, for example, "de" for German, "DE" for Germany, and "WIN" for Windows (or "MAC" for Macintosh).

The International Standards Organization (ISO) defines language and country codes. ISO 639 ([http://en.wikipedia.org/wiki/Iso\\_639](http://en.wikipedia.org/wiki/Iso_639)) defines language codes. ISO 3166 ([http://en.wikipedia.org/wiki/Iso\\_3166](http://en.wikipedia.org/wiki/Iso_3166)) defines country codes. `Locale` supports both standards.

Variant codes are useful for dealing with platform differences. For example, font differences may force you to use different characters on Windows-, Linux-, and Unix-based operating systems (such as Oracle Solaris). Unlike language and country codes, variant codes are not standardized.

Although applications can create their own `Locale` objects (perhaps to let users choose from similar locales), they will often call API methods that work with the *default locale*, which is the locale made available to the virtual machine at startup. An application can call `Locale`'s `Locale getDefault()` class method when it needs to access this locale.

For testing or other purposes, the application can override the default locale by calling `Locale`'s void `setDefault(Locale locale)` class method. `setDefault()` sets the default locale to `locale`. However, passing null to `locale` causes `setDefault()` to throw `java.lang.NullPointerException`.

**Note** On Android, `setDefault()` doesn't affect the system configuration. Attempts to override the system-provided default locale may themselves be overridden by actual changes to the system configuration. Code that calls this method is usually incorrect and should be fixed by passing the appropriate locale to each locale-sensitive method that's called.



Listing 16-17 demonstrates `getDefault()` and `setDefault()`.

*Listing 16-17. Viewing and Changing the Default Locale*

```
import java.util.Locale;

public class MyLocale
{
    public static void main(String[] args)
    {
        System.out.println(Locale.getDefault());
        Locale.setDefault(Locale.US);
        System.out.println(Locale.getDefault());
    }
}
```

Compile Listing 16-17 as follows:

```
javac MyLocale.java
```

Now run the application as follows:

```
java MyLocale
```

When I run `MyLocale`, I observe the following output—my default locale is Canada (`en_CA`):

---

```
en_CA
en_US
```

---

You can change the default locale that's made available to the virtual machine by assigning appropriate values to the `user.language` and `user.country` system properties when you launch the application via the `java` tool. For example, the following `java` command line changes the default locale to `fr_FR`:

```
java -Duser.language=fr -Duser.country=FR MyLocale
```

As you continue to explore `Locale`, you'll discover additional useful methods. For example, the `String[] getISOLanguages()` class method returns an array of ISO 639 language codes (including former and changed codes) and the `String[] getISOCountries()` class method returns an array of ISO 3166 country codes.

## Resource Bundles

An internationalized application contains no hard-coded text or other locale-specific elements (such as a specific currency format). Instead, each supported locale's version of these elements is stored outside of the application.

Java is responsible for storing each locale's version of certain elements, such as currency formats. In contrast, it's your responsibility to store each supported locale's version of other elements, such as text, audio clips, and locale-sensitive images.

Java facilitates this element storage by providing *resource bundles*, which are containers that hold one or more locale-specific elements, and which are each associated with one and only one locale.

Many applications work with one or more resource bundle families. Each family consists of resource bundles for all supported locales, and it typically contains one kind of element (perhaps text, or audio clips that contain language-specific verbal instructions).

Each family also shares a common *family name* (also known as a *base name*); each of its resource bundles has a unique locale designation that's appended to the family name to differentiate one resource bundle from another within the family.

Consider an internationalized text-based game application for English and French users. After choosing `game` as the family name, and `en` and `fr` as the English and French locale designations, you end up with the following complete resource bundle names:

- `game_en` is the complete resource bundle name for English users.
- `game_fr` is the complete resource bundle name for French users.

Although you can store all of your game's English text in the `game_en` resource bundle, you might want to differentiate between American and British text (such as `elevator` versus `lift`). This differentiation leads to the following complete resource bundle names:

- `game_en_US` is the complete resource bundle name for users who speak the American version of the English language.
- `game_en_GB` is the complete resource bundle name for users who speak the British version of the English language.

An application loads its resource bundles by calling the various `getBundle()` class methods that are located in the abstract `java.util.ResourceBundle` class. For example, the application might call the following `getBundle()` factory methods:

- `ResourceBundle getBundle(String baseName)` loads a resource bundle using the specified `baseName` and the default locale. For example, `ResourceBundle resources = ResourceBundle.getBundle("game");` attempts to load the resource bundle whose base name is `game` and whose locale designation matches the default locale. When the default locale is `en_US`, `getBundle()` attempts to load `game_en_US`.
- `ResourceBundle getBundle(String baseName, Locale locale)` loads a resource bundle using the specified `baseName` and `locale`. For example, `ResourceBundle resources = ResourceBundle.getBundle("game", new Locale("zh", "CN", "WIN"));` attempts to load the resource bundle whose base name is `game` and whose locale designation is Chinese with a Windows variant. In other words, `getBundle()` attempts to load `game_zh_CN_WIN`.

**Note** `ResourceBundle` is an example of a pattern that you'll discover throughout the Internationalization APIs. With few exceptions, each API is architected around an abstract entry-point class whose class methods return instances of concrete subclasses. For this reason, these class methods are also known as *factory methods*.

When the resource bundle identified by the base name and locale designation doesn't exist, the `getBundle()` methods search for the next closest bundle. For example, when the locale is `en_US` and `game_en_US` doesn't exist, `getBundle()` looks for `game_en`.

The `getBundle()` methods first generate a sequence of candidate bundle names for the specified locale (`language1`, `country1`, and `variant1`) and the default locale (`language2`, `country2`, and `variant2`) in the following order:

- `baseName + "_" + language1 + "_" + country1 + "_" + variant1`
- `baseName + "_" + language1 + "_" + country1`
- `baseName + "_" + language1`
- `baseName + "_" + language2 + "_" + country2 + "_" + variant2`
- `baseName + "_" + language2 + "_" + country2`
- `baseName + "_" + language2`
- `baseName`

Candidate bundle names in which the final component is an empty string are omitted from the sequence. For example, when `country1` is an empty string, the second candidate bundle name is omitted.

The `getBundle()` methods iterate over the candidate bundle names to find the first name for which they can instantiate an actual resource bundle. For each candidate bundle name, `getBundle()` attempts to create a resource bundle as follows:

- It first attempts to load a class that extends the abstract `java.util.ListResourceBundle` class using the candidate bundle name. If such a class can be found and loaded using the specified classloader, is assignment compatible with `ResourceBundle`, is accessible from `ResourceBundle`, and can be instantiated, `getBundle()` creates a new instance of this class and uses it as the result resource bundle.
- Otherwise, `getBundle()` attempts to locate a properties file. It generates a pathname from the candidate bundle name by replacing all "." characters with "/" and appending ".properties." It attempts to find a "resource" with this name using `ClassLoader.getResource()`. (Note that a "resource" in the sense of `getResource()` has nothing to do with the contents of a resource bundle; it's just a container of data, such as a file.) When `getResource()` finds a "resource," it attempts to create a new `java.util.PropertyResourceBundle` instance from its contents. When successful, this instance becomes the result resource bundle.

When no result resource bundle is found, `getBundle()` throws an instance of the `java.util.MissingResourceException` class; otherwise, `getBundle()` instantiates the bundle's parent resource bundle chain.

**Note** The parent resource bundle chain makes it possible to obtain fallback values when resources are missing. The chain is built by using `ResourceBundle`'s protected `void setParent(ResourceBundle parent)` method.

`getBundle()` builds the chain by iterating over the candidate bundle names that can be obtained by successively removing variant, country, and language (each time with the preceding “\_”) from the complete resource bundle name of the result resource bundle.

**Note** Candidate bundle names where the final component is an empty string are omitted.

With each candidate bundle name, `getBundle()` tries to instantiate a resource bundle as just described. When it succeeds, it calls the previously instantiated resource bundle's `setParent()` method with the new resource bundle unless the previously instantiated resource bundle already has a non-null parent.

**Note** `getBundle()` caches instantiated resource bundles and may return the same resource bundle instance multiple times.

`ResourceBundle` declares various methods for accessing a resource bundle's resources. For example, `Object getObject(String key)` gets an object for the given key from this resource bundle or one of its parent bundles.

`getObject()` first tries to obtain the object from this resource bundle using the protected abstract `handleGetObject()` method, which is implemented by concrete subclasses of `ResourceBundle` (such as `PropertyResourceBundle`).

If `handleGetObject()` returns null and if a non-null parent resource bundle exists, `getObject()` calls the parent's `getObject()` method. If still not successful, it throws `MissingResourceException`.

Two other resource-access methods are `String getString(String key)` and `String[] getStringArray(String key)`. These convenience methods are wrappers for `(String) getObject(key)` and `(String[]) getObject(key)`.

## Property Resource Bundles

A *property resource bundle* is a resource bundle backed by a *properties file*, a text file (with a `.properties` extension) that stores textual elements as a series of *key=value* entries. The *key* is a nonlocalized identifier that an application uses to obtain the localized *value*.

**Note** Properties files are accessed via instances of the `java.util.Properties` class. In Chapter 9, I mentioned that the Preferences API (discussed later in this chapter) has made `Properties` largely obsolete. Property resource bundles prove that the `Properties` class isn't entirely obsolete.

`PropertyResourceBundle`, a concrete subclass of `ResourceBundle`, manages property resource bundles. You should rarely (if ever) need to work with this subclass. Instead, for maximum portability, you should only work with `ResourceBundle`, which Listing 16-18 demonstrates.

*Listing 16-18. Accessing a Localized eLlevator Entry in game Resource Bundles*

```
import java.util.ResourceBundle;

public class PropertyResourceBundleDemo
{
    public static void main(String[] args)
    {
        ResourceBundle resources = ResourceBundle.getBundle("game");
        System.out.println("elevator = " + resources.getString("elevator"));
    }
}
```

Listing 16-18 refers to `ResourceBundle` instead of `PropertyResourceBundle`, which lets you easily migrate to `ListResourceBundle` as necessary. I use `getString()` instead of `getObject()` for convenience; text resources are stored in text-based properties files.

Compile Listing 16-18 as follows:

```
javac PropertyResourceBundleDemo.java
```

Run this application as follows:

```
java PropertyResourceBundleDemo
```

You'll observe the following output:

---

```
Exception in thread "main" java.util.MissingResourceException: Can't find bundle for base name game,
locale en_CA
    at java.util.ResourceBundle.throwMissingResourceException(Unknown Source)
    at java.util.ResourceBundle.getBundleImpl(Unknown Source)
    at java.util.ResourceBundle.getBundle(Unknown Source)
    at PropertyResourceBundleDemo.main(PropertyResourceBundleDemo.java:7)
```

---

This exception is thrown because no property resource bundles exist. You can easily remedy this situation by copying Listing 16-19 into a `game.properties` file, which is the basis for a property resource bundle.

*Listing 16-19. A Fallback game.properties Resource Bundle*

```
elevator=elevator
```

Assuming that `game.properties` is located in the same directory as `PropertyResourceBundleDemo.class`, execute `java PropertyResourceBundleDemo` and you'll see the following output:

---

```
elevator = elevator
```

---

Because my locale is `en_CA`, `getBundle()` first tries to load `game_en_CA.properties`. Because this file doesn't exist, `getBundle()` tries to load `game_en.properties`. Because this file doesn't exist, `getBundle()` tries to load `game.properties` and succeeds.

Now copy Listing 16-20 into a file named `game_en_GB.properties`.

*Listing 16-20. A game Resource Bundle for the en\_GB Locale*

```
elevator=lift
```

Continue by executing the following command line:

```
java -Duser.language=en -Duser.country=GB PropertyResourceBundleDemo
```

This time, you should see the following output:

---

```
elevator = lift
```

---

With the locale set to `en_GB`, `getBundle()` first tries to load `game_en_GB.properties` and succeeds.

Comment out `elevator = lift` by prepending a `#` character to this line (as in `#elevator = lift`). Then execute `java -Duser.language=en -Duser.country=GB PropertyResourceBundleDemo`, and you should see the following output:

---

```
elevator = elevator
```

---

Although `getBundle()` loaded `game_en_GB.properties`, `getString()` (via `getObject()`) couldn't find an `elevator` entry. As a result, `getString()/getObject()` searched the parent resource bundle chain, encountering `game.properties`' `elevator=elevator` entry whose `elevator` value was subsequently returned.

**Note** A common reason for `getString()` throwing `MissingResourceException` in a property resource bundle context is forgetting to append `.properties` to a properties file's name.

## List Resource Bundles

A *list resource bundle* is a resource bundle backed by a classfile, which describes a concrete subclass of `ListResourceBundle` (an abstract subclass of `ResourceBundle`). List resource bundles can store binary data (such as images or audio) as well as text. In contrast, property resource bundles can store text only.

**Note** When a property resource bundle and a list resource bundle have the same complete resource bundle name, the list resource bundle takes precedence over the property resource bundle. For example, when `getBundle()` is confronted with `game_en.properties` and `game_en.class`, it loads `game_en.class` instead of `game_en.properties`.

Listing 16-21 demonstrates a list resource bundle by presenting a `flags_en_CA` class that extends `ListResourceBundle`.

*Listing 16-21. A Resource Bundle Containing a Small Canadian Flag Image and English/French Text*

```
import java.awt.Toolkit;

import java.util.ListResourceBundle;

public class flags_en_CA extends ListResourceBundle
{
    private byte image[] =
    {
        (byte) 137,
        (byte) 80,
        (byte) 78,
        (byte) 71,
        (byte) 13,
        (byte) 10,
        (byte) 26,
        (byte) 10,
        (byte) 0,
        (byte) 0,
// ...
        (byte) 0,
        (byte) 0,
        (byte) 73,
        (byte) 69,
        (byte) 78,
        (byte) 68,
        (byte) 174,
        (byte) 66,
        (byte) 96,
        (byte) 130
    };
}
```

```

private Object[][] contents =
{
    { "flag", Toolkit.getDefaultToolkit().createImage(image) },
    { "msg", "Welcome to Canada! | Bienvenue vers le Canada !" },
    { "title", "CANADA | LA CANADA" }
};

public Object[][] getContents()
{
    return contents;
}
}

```

Listing 16-21's `flags_en_CA` class, which must be declared `public`, describes a list resource bundle whose base name is `flags` and whose locale designation is `en_CA`. This class's `image` array stores a Portable Network Graphics (PNG)-based sequence of byte integers that describes an image of the Canadian flag, `contents` stores key/value pairs, and `getContents()` returns `contents`.

**Note** For brevity, Listing 16-21 doesn't present the complete `image` array with Canadian flag image data. You must obtain `flags_en_CA.java` from this chapter's companion code file (see the book's introduction for instructions on how to obtain this file) to get the complete listing.

The first key/value pair consists of a key named `flag` (which will be passed to `ResourceBundle`'s `getObject()` method) and an instance of the `java.awt.Image` class. This instance represents the flag image and is obtained with the help of the `java.awt.Toolkit` class and its `createImage()` utility method.

Listing 16-22 shows you how to load the default `flags_en_CA` list resource bundle (or another list resource bundle via command-line arguments) and display its flag and text.

*Listing 16-22. Obtaining and Displaying a List Resource Bundle's Flag Image and Text*

```

import java.awt.EventQueue;
import java.awt.Image;

import java.util.Locale;
import java.util.ResourceBundle;

import javax.swing.ImageIcon;
import javax.swing.JOptionPane;

public class ListResourceBundleDemo
{
    public static void main(String[] args)
    {
        Locale l = Locale.CANADA;
        if (args.length == 2)
            l = new Locale(args[0], args[1]);
    }
}

```



```

final ResourceBundle resources = ResourceBundle.getBundle("flags", l);
Runnable r = new Runnable()
{
    @Override
    public void run()
    {
        Image image = (Image) resources.getObject("flag");
        String msg = resources.getString("msg");
        String title = resources.getString("title");
        ImageIcon ii = new ImageIcon(image);
        JOptionPane.showMessageDialog(null,
                                    msg,
                                    title,
                                    JOptionPane.PLAIN_MESSAGE,
                                    ii);
    }
};
EventQueue.invokeLater(r);
}
}

```

Listing 16-22's `main()` method begins by selecting `CANADA` as its default `Locale`. If it detects that two arguments were passed on the command line, `main()` assumes that the first argument is the language code and the second argument is the country code, and it creates a new `Locale` object based on these arguments as its default locale.

`main()` next attempts to load a list resource bundle by passing the `flags` base name and the previously-chosen `Locale` object to `ResourceBundle`'s `getBundle()` method. Assuming that `MissingResourceException` isn't thrown, `main()` creates a runnable task on which to load resources from the list resource bundle and display them graphically.

`main()` relies on a windowing toolkit known as *Swing* to present a simple user interface that displays the flag and text. Because *Swing* is single-threaded, where everything runs on a special thread known as the *event-dispatch thread* (EDT), it's important that all *Swing* operations occur on this thread. `EventQueue.invokeLater()` makes this happen.

**Note** *Swing* is built on top of the AWT and provides many sophisticated features. This windowing toolkit was officially released as part of Java 1.2 and continues to be part of Java's standard class library. *Swing* isn't supported by Android.

Shortly after `EventQueue.invokeLater()` is executed on the main thread, the EDT starts running and executes the runnable. This runnable first obtains the `Image` object from the list resource bundle by passing `flag` to `getObject()` and casting this method's return value to `Image`.

The runnable then obtains the `msg` and `title` strings by passing these keys to `getString()`, and it converts the `Image` object to a `javax.swing.ImageIcon` instance. This instance is required by the subsequent `javax.swing.JOptionPane.showMessageDialog()` method call, which presents a simple message-oriented dialog box.

**Note** JOptionPane is a Swing component that makes it easy to display a standard dialog box that prompts the user to enter a value or informs the user of something important.

Now that you understand how ListResourceBundleDemo works, obtain the complete flags\_en\_CA.java source file and then compile its source code along with Listing 16-22, as follows:

```
javac flags_en_CA.java
javac ListResourceBundleDemo.java
```

Execute the application as follows:

```
java ListResourceBundleDemo
```

Figure 16-1 shows the resulting user interface on Windows 7.

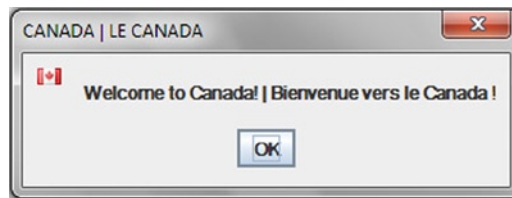

**Figure 16-1.** This almost completely localized dialog box (OK isn't localized) displays Canada-specific resources on Windows 7

**Note** I obtained the language translations for this section's examples from Yahoo! Babel Fish (<http://babelfish.yahoo.com/>), an online text translation service that no longer exists.

This book's accompanying code file also contains flags\_fr\_FR.java, which presents resources localized for the France locale. After compiling this source file, execute the following command line:

```
java ListResourceBundle fr FR
```

You should observe Figure 16-2 in response.



**Figure 16-2.** This almost completely localized dialog box displays France-specific resources on Windows 7

Finally, this book's accompanying code file also contains `flags_ru_RU.java`, which presents resources localized for the Russia locale. Compile this source file as follows:

```
javac -encoding Unicode flags_ru_RU.java
```

**Note** Because I stored Russian characters verbatim (and not as Unicode escape sequences, such as `'\u0041'`), `flags_ru_RU.java` is a Unicode-encoded file and must be compiled with the `-encoding Unicode` option. Also, you'll need to ensure that appropriate Cyrillic fonts are installed on your platform to view the Russian text.

Execute the resulting application as follows:

```
java ListResourceBundle ru RU
```

You should see Figure 16-3 as the result.

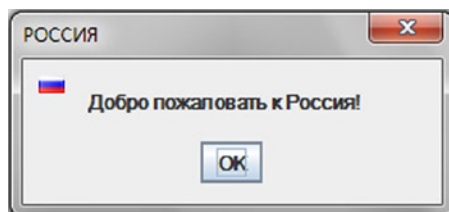

**Figure 16-3.** This almost completely localized dialog box displays Russia-specific resources on Windows 7

## Taking Advantage of Cache Clearing

Server applications are meant to run continuously; you'll probably lose customers and get a bad reputation if these applications fail often. As a result, it's preferable to change some aspect of their behavior interactively rather than stop and restart them.

Before Java 6, you couldn't dynamically update the resource bundles for a server application that obtains localized text from these bundles and sends this text to clients. Because resource bundles are cached, a change to a resource bundle properties file, for example, would never be reflected in the cache and ultimately not seen by the client.

Java 6 introduced `void clearCache()` and `void clearCache(ClassLoader loader)` class methods into `ResourceBundle` that make it possible to design a server application that clears out all cached resource bundles upon command. You would clear the cache after updating the appropriate resource bundle storage, which might be a file, a database table, or some other entity that stores resource data in some format.

To demonstrate cache clearing, I've created a date-server application that sends localized text and the current date (also localized) to clients. This application's source code is shown in Listing 16-23.

*Listing 16-23. A Date Server Whose Resource Bundle Cache Can Be Cleared on Command*

```
import java.io.Console;
import java.io.IOException;
import java.io.ObjectInputStream;
import java.io.PrintWriter;

import java.net.ServerSocket;
import java.net.Socket;

import java.text.MessageFormat;

import java.util.Date;
import java.util.Locale;
import java.util.MissingResourceException;
import java.util.ResourceBundle;

public class DateServer
{
    public final static int PORT = 5000;
    private ServerSocket ss;

    public DateServer(int port) throws IOException
    {
        ss = new ServerSocket(port);
    }

    public void runServer()
    {
        // This server application is console-based, as opposed to GUI-based.
        Console console = System.console();
        if (console == null)
        {
            System.err.println("unable to obtain system console");
            return;
        }
        // This would be a good place to log in the system administrator. For
        // simplicity, I've omitted this section.
        // Start a thread for handling client requests.
        Handler h = new Handler(ss);
        h.start();
    }
}
```

```
// Receive input from system administrator; respond to exit and clear
// commands.
while (true)
{
    String cmd = console.readLine(">");
    if (cmd == null)
        continue;
    if (cmd.equals("exit"))
        System.exit(0);
    if (cmd.equals("clear"))
        h.clearRBCache();
}

}

public static void main(String[] args) throws IOException
{
    new DateServer(PORT).runServer();
}

}

class Handler extends Thread
{
    private ServerSocket ss;
    private volatile boolean doClear;

    Handler(ServerSocket ss)
    {
        this.ss = ss;
    }

    void clearRBCache()
    {
        doClear = true;
    }

    @Override
    public void run()
    {
        ResourceBundle rb = null;
        while (true)
        {
            try
            {
                // Wait for a connection.
                Socket s = ss.accept();
                // Obtain the client's locale object.
                ObjectInputStream ois;
                ois = new ObjectInputStream(s.getInputStream());
                Locale l = (Locale) ois.readObject();
                // Prepare to output message back to client.
                PrintWriter pw = new PrintWriter(s.getOutputStream());
```

```

// Clear ResourceBundle's cache upon request.
if (doClear && rb != null)
{
    rb.clearCache();
    doClear = false;
}
// Obtain a resource bundle for the specified locale. If resource
// bundle cannot be found, the client is still waiting for
// something, so send a ?.
try
{
    rb = ResourceBundle.getBundle("datemsg", l);
}
catch (MissingResourceException mre)
{
    pw.println("?");
    pw.close();
    continue;
}
// Prepare a MessageFormat to format a locale-specific template
// containing a reference to a locale-specific date.
MessageFormat mf;
mf = new MessageFormat(rb.getString("datetemplate"), l);
Object[] args = { new Date() };
// Format locale-specific message and send to client.
pw.println(mf.format(args));
// It's important to close the PrintWriter so that message is
// flushed to the client socket's output stream.
pw.close();
}
catch (Exception e)
{
    System.err.println(e);
}
}
}
}

```

After obtaining the console, the date server starts a handler thread to respond to clients requesting the current date formatted to their locale requirements. I discuss the `java.text.MessageFormat` class that's instantiated on this thread later in this chapter.

Following this thread's creation, you're repeatedly prompted to enter a command: `clear` (clear the cache) and `exit` (exit the application) are the only two possibilities. After changing a resource bundle, type `clear` to ensure that future `getBundle()` method calls initially retrieve their bundles from storage (and then the cache on subsequent method calls).

Compile Listing 16-23 as follows:

```
javac DateServer.java
```

Run this application as follows:

```
java DateServer
```

You should observe a > prompt as the output.

The date server relies on resource bundles whose base name is `datetemplate`. I've created two bundles, which are stored in files named `datemsg_en.properties` and `datemsg_fr.properties`. The contents of the former file appear in Listing 16-24.

*Listing 16-24. The contents of `datemsg_en.properties`*

```
datetemplate = The date is {0, date, long}.
```

After connecting to the date server, a date-client application sends the server a `Locale` object; the client receives a `String` object in response. When the date server doesn't support the locale (a resource bundle cannot be found), it returns a string consisting of a single question mark. Otherwise, the date server returns a string consisting of localized text. Listing 16-25 presents the source code to a simple date-client application.

*Listing 16-25. Communicating with the Date Server*

```
import java.io.BufferedReader;
import java.io.InputStreamReader;
import java.io.ObjectOutputStream;

import java.net.Socket;

import java.util.Locale;

public class DateClient
{
    final static int PORT = 5000;

    public static void main(String[] args)
    {
        try
        {
            // Establish a connection to the date server. For simplicity, the
            // server is assumed to run on the same machine as the client. The
            // PORT constants of both server and client must be the same.
            Socket s = new Socket("localhost", PORT);
            // Send the default locale to the date server.
            ObjectOutputStream oos;
            oos = new ObjectOutputStream(s.getOutputStream());
            oos.writeObject(Locale.getDefault());
            // Obtain and output the server's response.
            InputStreamReader isr;
            isr = new InputStreamReader(s.getInputStream());
            BufferedReader br = new BufferedReader(isr);
            System.out.println(br.readLine());
        }
    }
}
```

```

        catch (Exception e)
        {
            System.err.println(e);
        }
    }
}

```

Compile Listing 16-25 as follows:

```
javac DateClient.java
```

Assuming that you've previously started the date server, execute the following command to run `DateClient`:

```
java DateClient
```

You should observe the current date in the default locale in reply.

For simplicity, the date client sends the default locale to the server. You can override this locale via the `java` tool's `-D` command-line option. For example, execute the following command to send a `Locale("fr", "")` object to the server:

```
java -Duser.language=fr -Duser.country="" DateClient
```

You should receive a reply in French, as demonstrated here:

---

```
La date est 21 décembre 2013.
```

---

You can verify the usefulness of cache clearing by performing a simple experiment with the date server and date client applications. Before you begin this experiment, create a second copy of Listing 16-24 in which “Thee” replaces “The”. Make sure that the properties file containing Thee is in the same directory as the date server, and then follow these steps:

1. Start the date server.
2. Run the client using `en` as the locale (via `java DateClient` when English is the default locale or via `java -Duser.language=en DateClient` otherwise). You should see a message beginning with “Thee date is.”
3. Copy the Listing 16-24 properties file to the server's directory.
4. Type `clear` at the server prompt.
5. Run the client using `en` as the locale. This time, you should see a message beginning with “The date is.”



**Caution** It's tempting to always want to invoke `clearCache()` before invoking `getBundle()`. However, doing so negates the performance benefit that caching brings to an application. For this reason, you should use `clearCache()` sparingly as the date server application demonstrates.

## Taking Control of the `getBundle()` Methods

Before Java 6, `ResourceBundle`'s `getBundle()` methods were hardwired to look for resource bundles as follows:

- *Look for certain kinds of bundles:* Properties-based or class-based.
- *Look in certain places:* Properties files or classfiles whose directory paths are indicated by fully qualified resource bundle base names.
- *Use a specific search strategy:* When a search based on a specified locale fails, perform the search using the default locale.
- *Use a specific loading procedure:* When a class and a properties file share the same candidate bundle name, the class is always loaded while the properties file remains hidden.

Furthermore, resource bundles were always cached.

Because this lack of flexibility prevents you from performing tasks such as obtaining resource data from sources other than properties files and classfiles (such as an XML file or a database), Java 6 reworked `ResourceBundle` to depend on a nested `Control` class. This nested class provides several callback methods that are invoked during the resource bundle search-and-load process. By overriding specific callback methods, you can achieve the desired flexibility. When none of these methods are overridden, the `getBundle()` methods behave as they always have.

`Control` offers the following methods:

- `List<Locale> getCandidateLocales(String baseName, Locale locale)` returns a list of candidate locales for the specified `baseName` and `locale`. `NullPointerException` is thrown when `baseName` or `locale` is null.
- `static ResourceBundle.Control getControl(List<String> formats)` returns a `ResourceBundle.Control` instance whose `getFormats()` method returns the specified formats. `NullPointerException` is thrown when the `formats` list is null and `java.lang.IllegalArgumentException` is thrown when the list of formats isn't known.
- `Locale getFallbackLocale(String baseName, Locale locale)` returns a fallback locale for further resource bundle searches (via `ResourceBundle.getBundle()`). `NullPointerException` is thrown when `baseName` or `locale` is null.
- `List<String> getFormats(String baseName)` returns a list of strings that identify the formats to be used in loading resource bundles that share the given `baseName`. `NullPointerException` is thrown when `baseName` is null.

- `static final ResourceBundle.Control getNoFallbackControl(List<String> formats)` returns a `ResourceBundle.Control` instance whose `getFormats()` method returns the specified formats and whose `getFallbackLocale()` method returns null. `NullPointerException` is thrown when the formats list is null and `IllegalArgumentException` is thrown when the list of formats isn't known.
- `long getTimeToLive(String baseName, Locale locale)` returns the time-to-live value for resource bundles loaded via this `ResourceBundle.Control` instance. `NullPointerException` is thrown when `baseName` or `locale` is null.
- `boolean needsReload(String baseName, Locale locale, String format, ClassLoader loader, ResourceBundle bundle, long loadTime)` determines when the expired cached bundle needs to be reloaded by comparing the last modified time with `loadTime`. It returns a true value (the bundle needs to be reloaded) when the last modified time is more recent than the `loadTime`. `NullPointerException` is thrown when `baseName`, `locale`, `format`, `loader`, or `bundle` is null.
- `ResourceBundle newBundle(String baseName, Locale locale, String format, ClassLoader loader, boolean reload)` creates a new resource bundle based on a combination of `baseName` and `locale`, and takes the `format` and `loader` into consideration. `NullPointerException` is thrown when `baseName`, `locale`, `format`, or `loader` is null (or when `toBundleName()`, which is called by this method, returns null). `IllegalArgumentException` is thrown when `format` is unknown or when the resource identified by the given parameters contains malformed data; `java.lang.ClassCastException` is thrown when the loaded class cannot be cast to `ResourceBundle`; `java.lang.IllegalAccessException` is thrown when the class or its noargument constructor isn't accessible; `java.lang.InstantiationException` is thrown when the class cannot be instantiated for some other reason; `java.lang.ExceptionInInitializerError` is thrown when the class's static initializer fails; and `IOException` is thrown when an I/O error occurs while reading resources using any I/O operations.
- `String toBundleName(String baseName, Locale locale)` converts the specified `baseName` and `locale` into a bundle name whose components are separated by underscore characters. For example, when `baseName` is `MyResources` and `locale` is `en`, the resulting bundle name is `MyResources_en`. `NullPointerException` is thrown when `baseName` or `locale` is null.
- `String toResourceName(String bundleName, String suffix)` converts the specified `bundleName` to a resource name. Forward-slash separators replace package period separators; a period followed by `suffix` is appended to the resulting name. For example, when `bundleName` is `com.company.MyResources_en` and `suffix` is `properties`, the resulting resource name is `com/company/MyResources_en.properties`. `NullPointerException` is thrown when `bundleName` or `suffix` is null.

The `getCandidateLocales()` method is called by a `ResourceBundle.getBundle()` class method each time the class method looks for a resource bundle for a target locale. You can override `getCandidateLocales()` to modify the target locale's parent chain. For example, when you want your Hong Kong resource bundles to share traditional Chinese strings, make `Chinese/Taiwan`

resource bundles the parent bundles of Chinese/Hong Kong resource bundles. *The Java Tutorial's* “Customizing Resource Bundle Loading” lesson (<http://download.oracle.com/javase/tutorial/i18n/resbundle/control.html>) shows how to accomplish this task.

The `getFallbackLocale()` method is called by a `ResourceBundle.getBundle()` class method each time the class method cannot find a resource bundle based on `getFallbackLocale()`'s `baseName` and `locale` arguments. You can override this method to return null when you don't want to continue a search using the default locale.

The `getFormats()` method is called by a `ResourceBundle.getBundle()` class method when it needs to load a resource bundle that's not found in the cache. This returned list of formats determines if the resource bundles being sought during the search are classfiles only, properties files only, both classfiles and properties files, or some other application-defined formats. When you override `getFormats()` to return application-defined formats, you'll also need to override `newBundle()` to load bundles based on these formats.

Earlier, I demonstrated using `clearCache()` to remove all resource bundles from `ResourceBundle`'s cache. Rather than explicitly clearing the cache, you can control how long resource bundles remain in the cache before they need to be reloaded by using the `getTimeToLive()` and `needsReload()` methods. The `getTimeToLive()` method returns one of the following values:

- A positive value representing the number of milliseconds that resource bundles loaded under the current `ResourceBundle.Control` instance can remain in the cache without being validated against their source data.
- 0 when the bundles must be validated each time they are retrieved from the cache.
- `ResourceBundle.Control.TTL_DONT_CACHE` when the bundles are not cached.
- The default `ResourceBundle.Control.TTL_NO_EXPIRATION_CONTROL` when the bundles are not to be removed from the cache under any circumstance (apart from low memory or when you explicitly clear the cache).

When a `ResourceBundle.getBundle()` class method finds an expired resource bundle in the cache, it calls `needsReload()` to determine whether or not the resource bundle should be reloaded. When this method returns true, `getBundle()` removes the expired resource bundle from the cache; a false return value updates the cached resource bundle with the time-to-live value returned from `getTimeToLive()`.

The `toBundleName()` method is called from the default implementations of `needsReload()` and `newBundle()` when they need to convert a base name and a locale to a bundle name. You can override this method to load resource bundles from different packages instead of the same package.

For example, assume that `MyResources.properties` stores your application's default (base) resource bundle and that you also have a `MyResources_de.properties` file for storing your application's German language resources. The default implementation of `ResourceBundle.Control` organizes these bundles in the same package. By overriding `toBundleName()` to change how these bundles are named, you can place them into different packages.

For example, you could have a `com.company.app.i18n.base.MyResources` package corresponding to the `com/company/app/i18n/base/MyResources.properties` resource file and a `com.company.app.i18n.de.MyResources` package corresponding to the `com/company/app/i18n/de/MyResources.properties` file.

You can learn how to do this by exploring a similar example in the Oracle/Sun Developer Network “International Enhancements in Java SE 6” article ([www.oracle.com/technetwork/articles/javase/i18n-enhance-137163.html](http://www.oracle.com/technetwork/articles/javase/i18n-enhance-137163.html)).

Although you will often subclass `ResourceBundle.Control` and override some combination of the callback methods, this isn’t always necessary. For example, when you want to restrict resource bundles to classfiles only or to properties files only, you can invoke `getControl()` to return a ready-made `ResourceBundle.Control` (thread-safe singleton) object that takes care of this task. To get this object, you will need to pass one of the following `ResourceBundle.Control` constants to `getControl()`:

- `FORMAT_PROPERTIES`, which describes an unmodifiable `java.util.List<String>` containing `"java.properties"`.
- `FORMAT_CLASS`, which describes an unmodifiable `List<String>` containing `"java.class"`.
- `FORMAT_DEFAULT`, which describes an unmodifiable `List<String>` containing `"java.class"` followed by `"java.properties"`.

The first example in `ResourceBundle.Control`’s JDK documentation uses `getControl()` to return a `ResourceBundle.Control` instance that restricts resource bundles to properties files.

You can also invoke `getNoFallbackControl()` to return a ready-made `ResourceBundle.Control` instance that (in addition to restricting resource bundles to classfiles or properties files only) tells the new `getBundle()` methods to avoid falling back to the default locale when searching for a resource bundle. The `getNoFallbackControl()` method recognizes the same `formats` argument as `getControl()`; it returns a thread-safe singleton whose `getFallbackLocale()` method returns null.

## Break Iterators

Internationalized text-processing applications (such as word processors) need to detect logical boundaries within the text they’re manipulating. For example, a word processor needs to detect these boundaries when highlighting a character, selecting a word to cut to the clipboard, moving the *caret* (text insertion point indicator) to the start of the next sentence, and wrapping a word at the end of a line.

Java provides the Break Iterator API with its abstract `java.text.BreakIterator` entry-point class to detect text boundaries.

`BreakIterator` declares the following class methods for obtaining break iterators that detect character, word, sentence, and line boundaries:

- `BreakIterator` `getCharacterInstance()`
- `BreakIterator` `getWordInstance()`
- `BreakIterator` `getSentenceInstance()`
- `BreakIterator` `getLineInstance()`

Each of these class methods returns a break iterator for the default locale.

When you need a break iterator for a specific locale, you can call the following class methods:

- `BreakIterator getCharacterInstance(Locale locale)`
- `BreakIterator getWordInstance(Locale locale)`
- `BreakIterator getSentenceInstance(Locale locale)`
- `BreakIterator getLineInstance(Locale locale)`

Each of these class methods throws `NullPointerException` when its `locale` argument is `null`.

`BreakIterator`'s locale-sensitive class methods might not support every locale. For this reason, you should only pass `Locale` objects that are also stored in the array returned from this class's `Locale[] getAvailableLocales()` class method (which is also declared in other entry-point classes) to the aforementioned class methods; this array contains at least `Locale.US`. Check out the following example:

```
Locale[] supportedLocales = BreakIterator.getAvailableLocales();
BreakIterator bi = BreakIterator.getCharacterInstance(supportedLocales[0]);
```

This example obtains `BreakIterator`'s supported locales and passes the first locale (possibly `Locale.US`) to `getCharacterInstance(Locale)`.

A `BreakIterator` instance has an imaginary cursor that points to the current boundary within a text string. This cursor position can be interrogated and the cursor moved from boundary to boundary with the help of the following `BreakIterator` methods:

- `int current()` returns the text boundary that was most recently returned by `next()`, `next(int)`, `previous()`, `first()`, `last()`, `following(int)`, or `preceding(int)`. When any of these methods returns `BreakIterator.DONE` because either the first or the last text boundary has been reached, `current()` returns the first or last text boundary depending on which one was reached.
- `int first()` returns the first text boundary. The iterator's current position is set to this boundary.
- `int following(int offset)` returns the first text boundary following the specified character offset. When `offset` equals the last text boundary, `following(int)` returns `BreakIterator.DONE` and the iterator's current position is unchanged. Otherwise, the iterator's current position is set to the returned text boundary. The value returned is always greater than `offset` or `BreakIterator.DONE`.
- `int last()` returns the last text boundary. The iterator's current position is set to this boundary.
- `int next()` returns the text boundary following the current boundary. When the current boundary is the last text boundary, `next()` returns `BreakIterator.DONE` and the iterator's current position is unchanged. Otherwise, the iterator's current position is set to the boundary following the current boundary.

- `int next(int n)` returns the *n*th text boundary from the current boundary. When either the first or the last text boundary has been reached, `next(int)` returns `BreakIterator.DONE` and the current position is set either to the first or last text boundary depending on which one is reached. Otherwise, the iterator's current position is set to the new text boundary.
- `int preceding(int offset)` returns the last text boundary preceding the specified character offset. When `offset` equals the first text boundary, `preceding(int)` returns `BreakIterator.DONE` and the iterator's current position is unchanged. Otherwise, the iterator's current position is set to the returned text boundary. The returned value is always less than `offset` or equals `BreakIterator.DONE`. (This method was added to `BreakIterator` in Java 1.2. It couldn't be declared abstract because abstract methods cannot be added to existing classes; such methods would also have to be implemented in subclasses that might be inaccessible.)
- `int previous()` returns the text boundary preceding the current boundary. When the current boundary is the first text boundary, `previous()` returns `BreakIterator.DONE` and the iterator's current position is unchanged. Otherwise, the iterator's current position is set to the boundary preceding the current boundary.

Figure 16-4 reveals that characters are located between boundaries, boundaries are zero-based, and the last boundary is the length of the string.

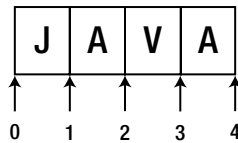

**Figure 16-4.** JAVA's character boundaries appear as reported by the `next()` and `previous()` methods

`BreakIterator` also declares a void `setText(String newText)` method that identifies `newText` as the text to be iterated over. This method resets the cursor position to the beginning of this string.

Listing 16-26 shows how to use a character-based break iterator to iterate over a string's characters in a locale-independent manner.

**Listing 16-26.** Iterating Over English/US and Arabic/Saudi Arabia Strings

```
import java.text.BreakIterator;

import java.util.Locale;

public class BreakIteratorDemo
{
    public static void main(String[] args)
    {
        BreakIterator bi = BreakIterator.getCharacterInstance(Locale.US);
        bi.setText("JAVA");
        dumpPositions(bi);
    }
}
```

```

    bi = BreakIterator.getInstance(new Locale("ar", "SA"));
    bi.setText("\u0631\u0641\u0651");
    dumpPositions(bi);
}

static void dumpPositions(BreakIterator bi)
{
    int boundary = bi.first();
    while (boundary != BreakIterator.DONE)
    {
        System.out.print(boundary + " ");
        boundary = bi.next();
    }
    System.out.println();
}
}

```

Listing 16-26's `main()` method first obtains a character-based break iterator for the United States locale. `main()` then calls the iterator's `setText()` method to specify JAVA as the text to be iterated over.

Iteration occurs in the `dumpPositions()` method. After calling `first()` to obtain the first boundary, this method uses a `while` loop to output the boundary and move to the next boundary (via `next()`) while the current boundary doesn't equal `BreakIterator.DONE`.

Because character iteration is straightforward for English words, `main()` next obtains a character-based break iterator for the Saudi Arabia locale and uses this iterator to iterate over the characters in Figure 16-5's Arabic version of "shelf" (as in shelf of books).

ر ف ء

ر    resh (letter)  
 ف    pe (letter)  
 ء    shadda (diacritic)

**Figure 16-5.** The letters and diacritic making up the Arabic equivalent of "shelf" are written from right to left

In Arabic, the word "shelf" consists of letters resh and pe, and diacritic shadda. A *diacritic* is an ancillary *glyph*, or mark on paper or other writing medium, added to a letter, or basic glyph. Shadda, which is shaped like a small written Latin *w*, indicates *gemination* (consonant doubling or extra length), which is *phonemic* (the smallest identifiable discrete unit of sound employed to form meaningful contrasts between utterances) in Arabic. Shadda is written above the consonant that's to be doubled, which happens to be pe in this example.

Compile Listing 16-26 as follows:

```
javac BreakIteratorDemo.java
```

Run this application as follows:

```
java BreakIteratorDemo
```

You observe the following output:

---

```
0 1 2 3 4
0 1 3
```

---

The first output line reveals Figure 16-4’s character boundaries for the word JAVA. The second output line (0 comes before resh, 1 comes before pe) implies that you cannot move an Arabic word processor’s caret on the screen once for every Unicode character. Instead, it’s moved once for every *user character*, a logical character that can be composed of multiple Unicode characters, such as pe (\u0641) and shadda (\u0651).

**Note** For examples of break iterators that iterate over words, sentences, and lines, check out the “Detecting Text Boundaries” section (<http://download.oracle.com/javase/tutorial/i18n/text/boundaryintro.html>) in *The Java Tutorials*.

## Collators

Applications perform string comparisons while sorting text. When an application targets English-oriented users, `String`’s `compareTo()` method is probably sufficient for comparing strings. However, this method’s binary comparison of each string’s Unicode characters isn’t reliable for languages where the relative order of their characters doesn’t correspond to the Unicode values of these characters. French is one example.

Java provides the Collator API with its abstract `java.text.Collator` entry-point class for making reliable comparisons. `Collator` declares the following class methods for obtaining collators:

- `Collator getInstance()`
- `Collator getInstance(Locale locale)`

The first class method obtains a collator for the default locale; the second class method throws `NullPointerException` when its `locale` argument is `null`. As with `BreakIterator`, you should only pass `Locale` objects that are also stored in the array returned from `Collator`’s `Locale[] getAvailableLocales()` class method to `getInstance(Locale)`.

Listing 16-27 shows how to use a collator to perform comparisons so that French words differing only in terms of accented characters are sorted into the correct order.



*Listing 16-27. Using a Collator to Order French Words Correctly in the France Locale*

```
import java.text.Collator;

import java.util.Arrays;
import java.util.Locale;

public class CollatorDemo
{
    public static void main(String[] args)
    {
        Collator en_USCollator = Collator.getInstance(Locale.US);
        Collator fr_FRCollator = Collator.getInstance(Locale.FRANCE);
        String[] words =
        {
            "côte", "coté", "côté", "cote"
        };
        Arrays.sort(words, en_USCollator);
        for (String word: words)
            System.out.println(word);
        System.out.println();
        Arrays.sort(words, fr_FRCollator);
        for (String word: words)
            System.out.println(word);
    }
}
```

In Listing 16-27, each of the four words being sorted has a different meaning. For example, *côte* means coast and *côté* means side.

Compile Listing 16-27 as follows:

```
javac CollatorDemo.java
```

Run this application as follows:

```
java CollatorDemo
```

I observe the following output in Windows Notepad:

---

```
cote
coté
côte
côté
```

```
cote
côte
coté
côté
```

---

The first four output lines show the order in which these words are sorted according to the en\_US locale. This ordering isn't correct because it doesn't account for accents. In contrast, the final four output lines show the correct order when the words are sorted according to the fr\_FR locale. Words are compared as if none of the characters contain accents and then equal words are compared from right to left for accents.

**Note** Learn about Collator's `java.text.RuleBasedCollator` subclass for creating custom collators when predefined collation rules don't meet your needs, and about improving collation performance via `java.text.CollationKey` and Collator's `CollationKey.getCollationKey(String source)` method, by reading the "Comparing Strings" section (<http://download.oracle.com/javase/tutorial/i18n/text/collationintro.html>) in *The Java Tutorials*.

## Dates, Time Zones, and Calendars

Internationalized applications must properly handle dates, time zones, and calendars. A *date* is a recorded temporal moment, a *time zone* is a set of geographical regions that share a common number of hours relative to Greenwich Mean Time (GMT), and a *calendar* is a system of organizing the passage of time.

**Note** GMT identifies the standard geographical location from where all time is measured. UTC, which stands for Coordinated Universal Time, is often specified in place of GMT.

Java 1.0 introduced the `java.util.Date` class as its first attempt to describe calendars. However, `Date` was not amenable to internationalization because of its English-oriented nature and because of its inability to represent dates prior to midnight January 1, 1970 GMT, which is known as the *Unix epoch* (the date when Unix began to be used).

`Date` was eventually refactored to make it more useful by allowing `Date` instances to represent dates before the epoch as well as after the epoch, and by deprecating most of this class's constructors and methods; deprecated methods have been replaced by more appropriate API classes. Table 16-2 describes the more useful `Date` class.

**Table 16-2.** *Date Constructors and Methods*

Method	Description
<code>Date()</code>	Allocates a <code>Date</code> object and initializes it to the current time by calling <code>System.currentTimeMillis()</code> .
<code>Date(long date)</code>	Allocates a <code>Date</code> object and initializes it to the time represented by <code>date</code> milliseconds. A negative value indicates a time before the epoch, 0 indicates the epoch, and a positive value indicates a time after the epoch.
<code>boolean after(Date date)</code>	Returns true when this date occurs after <code>date</code> . This method throws <code>NullPointerException</code> when <code>date</code> is null.
<code>boolean before(Date date)</code>	Returns true when this date occurs before <code>date</code> . This method throws <code>NullPointerException</code> when <code>date</code> is null.
<code>Object clone()</code>	Returns a copy of this object.
<code>int compareTo(Date date)</code>	Compares this date with <code>date</code> . Returns 0 when this date equals <code>date</code> , a negative value when this date comes before <code>date</code> , and a positive value when this date comes after <code>date</code> . This method throws <code>NullPointerException</code> when <code>date</code> is null.
<code>boolean equals(Object obj)</code>	Compares this date with the <code>Date</code> object represented by <code>obj</code> . Returns true if and only if <code>obj</code> isn't null and is a <code>Date</code> object that represents the same point in time (to the millisecond) as this date.
<code>long getTime()</code>	Returns the number of milliseconds that must elapse before the epoch (a negative value) or have elapsed since the epoch (a positive value).
<code>int hashCode()</code>	Returns this date's hash code. The result is the exclusive OR of the two halves of the long integer value returned by <code>getTime()</code> . That is, the hash code is the value of expression <code>(int) (this.getTime() ^ (this.getTime() &gt;&gt;&gt; 32))</code> .
<code>void setTime(long time)</code>	Sets this date to represent the point in time specified by <code>time</code> milliseconds (a negative value refers to before the epoch; a positive value refers to after the epoch).
<code>String toString()</code>	Returns a <code>String</code> object containing this date's representation as <code>dow mon dd hh:mm:ss zzz yyyy</code> , where <code>dow</code> is the day of the week (Sun, Mon, Tue, Wed, Thu, Fri, Sat), <code>mon</code> is the month (Jan, Feb, Mar, Apr, May, Jun, Jul, Aug, Sep, Oct, Nov, Dec), <code>dd</code> is the two decimal-digit day of the month (01 through 31), <code>hh</code> is the two decimal-digit hour of the day (00 through 23), <code>mm</code> is the two decimal-digit minute within the hour (00 through 59), <code>ss</code> is the two decimal-digit second within the minute (00 through 61, where 60 and 61 account for leap seconds), <code>zzz</code> is the (possibly empty) time zone (and may reflect daylight saving time), and <code>yyyy</code> is the four decimal-digit year.

Listing 16-28 provides a small demonstration of the Date class.

*Listing 16-28. Exploring the Date Class*

```
import java.util.Date;

public class DateDemo
{
    public static void main(String[] args)
    {
        Date now = new Date();
        System.out.println(now);
        Date later = new Date(now.getTime() + 86400);
        System.out.println(later);
        System.out.println(now.after(later));
        System.out.println(now.before(later));
    }
}
```

Listing 16-28's `main()` method creates a pair of `Date` objects (`now` and `later`) and outputs their dates, formatted according to `Date`'s implicitly called `toString()` method. `main()` then demonstrates `after()` and `before()`, proving that `now` comes before `later`, which is one second in the future.

Compile Listing 16-28 as follows:

```
javac DateDemo.java
```

Run this application as follows:

```
java DateDemo
```

You should observe output similar to the following:

---

```
Sat Jan 04 13:25:20 CST 2014
Sat Jan 04 13:26:47 CST 2014
false
true
```

---

`Date`'s `toString()` method reveals that a time zone is part of a date. Java provides the abstract `java.util.TimeZone` entry-point class for obtaining instances of `TimeZone` subclasses. This class declares a pair of class methods for obtaining these instances:

- `TimeZone getDefault()`
- `TimeZone getTimeZone(String ID)`

The latter method returns a `TimeZone` instance for the time zone whose `String` identifier (such as "CST") is passed to `ID`.

**Note** Some time zones take into account *daylight saving time*, the practice of temporarily advancing clocks so that afternoons have more daylight and mornings have less, for example, Central Daylight Time (CDT). Check out Wikipedia's "Daylight saving time" entry ([http://en.wikipedia.org/wiki/Daylight\\_saving\\_time](http://en.wikipedia.org/wiki/Daylight_saving_time)) to learn more about daylight saving time.

When you need to introduce a new time zone or modify an existing time zone, perhaps to deal with changes to a time zone's daylight saving time policy, you can work directly with `TimeZone`'s `java.util.SimpleTimeZone` concrete subclass. `SimpleTimeZone` describes a raw offset from GMT and provides rules for specifying the start and end of daylight saving time.

Java 1.1 introduced the `Calendar` API with its abstract `java.util.Calendar` entry-point class as a replacement for `Date`. `Calendar` is intended to represent any kind of calendar. However, time constraints meant that only the Gregorian calendar could be implemented (via the concrete `java.util.GregorianCalendar` subclass) for version 1.1.

**Note** Java 1.4 introduced support for the Thai Buddhist calendar via an internal class that subclasses `Calendar`. Java 6 introduced support for the Japanese Imperial Era calendar via the package-private `java.util.JapaneseImperialCalendar` class, which also subclasses `Calendar`.

`Calendar` declares the following class methods for obtaining calendars:

- `Calendar getInstance()`
- `Calendar getInstance(Locale locale)`
- `Calendar getInstance(TimeZone zone)`
- `Calendar getInstance(TimeZone zone, Locale locale)`

The first and third methods return calendars for the default locale; the second and fourth methods take the specified locale into account. Also, calendars returned by the first two methods are based on the current time in the default time zone; calendars returned by the last two methods are based on the current time in the specified time zone.

`Calendar` declares various constants, including `YEAR`, `MONTH`, `DAY_OF_MONTH`, `DAY_OF_WEEK`, `LONG`, and `SHORT`. These constants identify the year (four digits), month (0 represents January), current month day (1 through the month's last day), and current weekday (1 represents Sunday) calendar fields, and display styles (such as January versus Jan).

The first four constants are used with `Calendar`'s various `set()` methods to set calendar fields to specific values (set the year field to 2012, for example). They're also used with `Calendar`'s `int get(int field)` method to return field values, along with other field-oriented methods such as `void clear(int field)` (unset a field).

The latter two constants are used with Calendar's String `getDisplayName(int field, int style, Locale locale)` and `Map<String,Integer> getDisplayNames(int field, int style, Locale locale)` methods, which return short (Jan, for example) or long (January, for example) localized String representations of various field values.

Listing 16-29 shows how to use various Calendar constants and methods to output calendar pages according to the `en_US` and `fr_FR` locales.

*Listing 16-29. Outputting Calendar Pages*

```
import java.util.Calendar;
import java.util.Iterator;
import java.util.Locale;
import java.util.Map;
import java.util.Set;

public class CalendarDemo
{
    public static void main(String[] args)
    {
        if (args.length < 2)
        {
            System.err.println("usage: java CalendarDemo yyyy mm [f|F]");
            return;
        }
        try
        {
            int year = Integer.parseInt(args[0]);
            int month = Integer.parseInt(args[1]);
            Locale locale = Locale.US;
            if (args.length == 3 && args[2].equalsIgnoreCase("f"))
                locale = Locale.FRANCE;
            showPage(year, month, locale);
        }
        catch (NumberFormatException nfe)
        {
            System.err.print(nfe);
        }
    }

    static void showPage(int year, int month, Locale locale)
    {
        if (month < 1 || month > 12)
            throw new IllegalArgumentException("month [" + month + "] out of " +
                "range [1, 12]");
        Calendar cal = Calendar.getInstance(locale);
        cal.set(Calendar.YEAR, year);
        cal.set(Calendar.MONTH, --month);
        cal.set(Calendar.DAY_OF_MONTH, 1);
        displayMonthAndYear(cal, locale);
        displayWeekdayNames(cal, locale);
    }
}
```

```

int daysInMonth = cal.getActualMaximum(Calendar.DAY_OF_MONTH);
int firstRowGap = cal.get(Calendar.DAY_OF_WEEK)-1; // 0 = Sunday
for (int i = 0; i < firstRowGap; i++)
    System.out.print(" ");
for (int i = 1; i <= daysInMonth; i++)
{
    if (i < 10)
        System.out.print(' ');
    System.out.print(i);
    if ((firstRowGap + i) % 7 == 0)
        System.out.println();
    else
        System.out.print(' ');
}
System.out.println();
}

static void displayMonthAndYear(Calendar cal, Locale locale)
{
    System.out.println(cal.getDisplayName(Calendar.MONTH, Calendar.LONG,
                                           locale) + " " +
                       cal.get(Calendar.YEAR));
}

static void displayWeekdayNames(Calendar cal, Locale locale)
{
    Map<String, Integer> weekdayNamesMap;
    weekdayNamesMap = cal.getDisplayNames(Calendar.DAY_OF_WEEK,
                                           Calendar.SHORT, locale);

    String[] names = new String[weekdayNamesMap.size()];
    int[] indexes = new int[weekdayNamesMap.size()];
    Set<Map.Entry<String, Integer>> weekdayNamesEntries;
    weekdayNamesEntries = weekdayNamesMap.entrySet();
    Iterator<Map.Entry<String, Integer>> iter;
    iter = weekdayNamesEntries.iterator();
    while (iter.hasNext())
    {
        Map.Entry<String, Integer> entry = iter.next();
        names[entry.getValue() - 1] = entry.getKey();
        indexes[entry.getValue() - 1] = entry.getValue();
    }
    for (int i = 0; i < names.length; i++)
        for (int j = i; j < names.length; j++)
            if (indexes[j] == i + 1)
            {
                System.out.print(names[j].substring(0, 2) + " ");
                continue;
            }
    System.out.println();
}
}

```

Listing 16-29 is pretty straightforward with the exception of `displayWeekdayNames()`. This method calls `Calendar`'s `getDisplayNames()` method to return a map of localized weekday names. Instead of returning a map where the keys are `java.lang.Integers` and the values are localized `Strings`, this map's keys are the localized `Strings`.

This would be fine if the keys were ordered (as in Sunday first and Saturday last, or `lundi` first and `dimanche` last). However, they're not ordered. To output these names in order, it's necessary to obtain a set of map entries, iterate over these entries and populate parallel arrays, and then iterate over these arrays to output the weekday names.

**Note** A French calendar begins the week on `lundi` (Monday) and ends it on `dimanche` (Sunday). However, `Calendar` doesn't take this ordering into account.

Compile Listing 16-29 as follows:

```
javac CalendarDemo.java
```

Run this application with an appropriate year, month, and locale:

```
java CalendarDemo 2014 01
```

When I specify the previous command line for the `en_CA` locale, I observe the following calendar page:

---

```
January 2014
Su Mo Tu We Th Fr Sa
      1  2  3  4
 5  6  7  8  9 10 11
12 13 14 15 16 17 18
19 20 21 22 23 24 25
26 27 28 29 30 31
```

---

If you would like to see this page in the `fr_FR` locale, specify either of the following command lines:

```
java CalendarDemo 2014 01 f
java CalendarDemo 2014 01 F
```

You should then observe the following calendar page:

---

```
janvier 2014
di lu ma me je ve sa
      1  2  3  4
 5  6  7  8  9 10 11
12 13 14 15 16 17 18
19 20 21 22 23 24 25
26 27 28 29 30 31
```

---



**Note** Calendar declares a `Date getTime()` method that returns a calendar's time representation as a `Date` instance. Calendar also declares a `void setTime(Date date)` method that sets a calendar's time representation to the specified date.

## Formatters

Internationalized applications don't present unformatted numbers (including currencies and percentages), dates, and messages to the user. These items must be formatted according to the user's locale so that they appear meaningful. To help with formatting, Java provides the abstract `java.text.Format` class and various subclasses.

## Number Formatters

The abstract `java.text.NumberFormat` entry-point class (a `Format` subclass) declares the following class methods to return formatters that format numbers as currencies, integers, numbers with decimal points, and percentages (and also to parse such values):

- `NumberFormat getCurrencyInstance()`
- `NumberFormat getCurrencyInstance(Locale locale)`
- `NumberFormat getIntegerInstance()`
- `NumberFormat getIntegerInstance(Locale locale)`
- `NumberFormat getInstance()`
- `NumberFormat getInstance(Locale locale)`
- `NumberFormat getNumberInstance()`
- `NumberFormat getNumberInstance(Locale locale)`
- `NumberFormat getPercentInstance()`
- `NumberFormat getPercentInstance(Locale locale)`

The `getInstance()` and `getInstance(Locale)` class methods are equivalent to `getNumberInstance()` and `getNumberInstance(Locale)`. They're present as a shorthand convenience to the longer-named `getNumberInstance()` methods.

Listing 16-30 shows you how to obtain and use number formatters to format numbers as currencies, integers, numbers with decimal points, and percentages for various locales.

*Listing 16-30. Formatting Numbers as Currencies, Integers, Numbers with Decimal Points, and Percentages*

```
import java.text.NumberFormat;

import java.util.Locale;

public class NumberFormatDemo
{
    public static void main(String[] args)
    {
        System.out.println("Unformatted: " + 9875432.25);
        formatCurrencies(Locale.US, 98765432.25);
        formatCurrencies(Locale.FRANCE, 98765432.25);
        formatCurrencies(Locale.GERMANY, 98765432.25);
        System.out.println();
        System.out.println("Unformatted: " + 123456789.0);
        formatIntegers(Locale.US, 123456789.0);
        formatIntegers(Locale.FRANCE, 123456789.0);
        formatIntegers(Locale.GERMANY, 123456789.0);
        System.out.println();
        System.out.println("Unformatted: " + 6751.326);
        formatNumbers(Locale.US, 6751.326);
        formatNumbers(Locale.FRANCE, 6751.326);
        formatNumbers(Locale.GERMANY, 6751.326);
        System.out.println();
        System.out.println("Unformatted: " + 0.85);
        formatPercentages(Locale.US, 0.85);
        formatPercentages(Locale.FRANCE, 0.85);
        formatPercentages(Locale.GERMANY, 0.85);
    }

    static void formatCurrencies(Locale locale, double amount)
    {
        NumberFormat nf = NumberFormat.getCurrencyInstance(locale);
        System.out.println(locale+" : " + nf.format(amount));
    }

    static void formatIntegers(Locale locale, double amount)
    {
        NumberFormat nf = NumberFormat.getIntegerInstance(locale);
        System.out.println(locale+" : " + nf.format(amount));
    }

    static void formatNumbers(Locale locale, double amount)
    {
        NumberFormat nf = NumberFormat.getNumberInstance(locale);
        System.out.println(locale+" : " + nf.format(amount));
    }
}
```

```

static void formatPercentages(Locale locale, double amount)
{
    NumberFormat nf = NumberFormat.getPercentInstance(locale);
    System.out.println(locale + ": " + nf.format(amount));
}
}

```

Listing 16-30 uses a double instead of a `java.math.BigDecimal` object to represent 9875432.25 as a currency, for simplicity and because this value can be represented exactly as a double.

Compile Listing 16-30 as follows:

```
javac NumberFormatDemo.java
```

Run this application as follows:

```
java NumberFormatDemo
```

Figure 16-6 shows the resulting output in the Windows Notepad editor.

```

out - Notepad
File Edit Format View Help
Unformatted: 9875432.25
en_US: $98,765,432.25
fr_FR: 98 765 432,25 €
de_DE: 98.765.432,25 €

Unformatted: 1.23456789E8
en_US : 123,456,789
fr_FR : 123 456 789
de_DE : 123.456.789

Unformatted: 6751.326
en_US: 6,751.326
fr_FR: 6 751,326
de_DE: 6.751,326

Unformatted: 0.85
en_US: 85%
fr_FR: 85 %
de_DE: 85%

```

**Figure 16-6.** Windows Notepad reveals unformatted and formatted numeric output for the US, France, and Germany locales

`NumberFormat` declares `void setMaximumFractionDigits(int newValue)`, `void setMaximumIntegerDigits(int newValue)`, `void setMinimumFractionDigits(int newValue)`, and `void setMinimumIntegerDigits(int newValue)` methods to limit the number of digits that are

allowed in a formatted number's integer or fraction. These methods are helpful for aligning numbers, as the following example demonstrates:

```
NumberFormat nf = NumberFormat.getInstance();
System.out.println(nf.format(123.4567)); // I observe 123.457
nf.setMaximumIntegerDigits(10);
nf.setMinimumIntegerDigits(6);
nf.setMaximumFractionDigits(2);
nf.setMinimumFractionDigits(2);
System.out.println(nf.format(123.4567)); // I observe 000,123.46
System.out.println(nf.format(80978.3)); // I observe 080,978.30
```

This example specifies that a number's integer portion cannot exceed ten digits but must have a minimum of six digits. Leading zeros are output to meet the minimum. The example reveals that the fraction is rounded.

A concrete subclass of `NumberFormat` might enforce an upper limit on the value passed to `setMaximumFractionDigits(int)`, `setMaximumIntegerDigits(int)`, `setMinimumFractionDigits(int)`, or `setMinimumIntegerDigits(int)`. Call `getMaximumFractionDigits()`, `getMaximumIntegerDigits()`, `getMinimumFractionDigits()`, or `getMinimumIntegerDigits()` to find out if the value you specified has been accepted.

**Note** When you need to create customized number formatters, you'll find yourself working with `NumberFormat`'s `java.text.DecimalFormat` subclass and this subclass's `java.text.DecimalFormatSymbols` companion class. The "Customizing Formats" section (<http://download.oracle.com/javase/tutorial/i18n/format/decimalFormat.html>) in *The Java Tutorials* introduces you to these classes.

## Date Formatters

The abstract `java.text.DateFormat` entry-point class (a `Format` subclass) provides access to formatters that format `Date` instances as dates or time values (and also to parse such values). This class declares the following class methods:

- `DateFormat getDateInstance()`
- `DateFormat getDateInstance(int style)`
- `DateFormat getDateInstance(int style, Locale locale)`
- `DateFormat getTimeInstance()`
- `DateFormat getTimeInstance(int dateStyle, int timeStyle)`
- `DateFormat getTimeInstance(int dateStyle, int timeStyle, Locale locale)`
- `DateFormat getInstance()`

- `DateFormat getTimeInstance()`
- `DateFormat getTimeInstance(int style)`
- `DateFormat getTimeInstance(int style, Locale locale)`

The `getDateInstance()` class methods' formatters generate only date information, the `getTimeInstance()` class methods' formatters generate only time information, and the `getDateTimeInstance()` class methods' formatters generate date and time information.

The `dateStyle` and `timeStyle` fields determine how that information will be presented according to the following `DateFormat` constants:

- `SHORT` is completely numeric, such as 12.13.52 or 3:30pm.
- `MEDIUM` is longer, such as Jan 12, 1952.
- `LONG` is longer still, such as January 12, 1952 or 3:30:32pm.
- `FULL` is pretty completely specified, such as Tuesday, April 12, 1952 AD or 3:30:42pm PST.

Listing 16-31 shows you how to format a `Date` instance that represents the Unix epoch according to the local time zone and the UTC time zone.

*Listing 16-31. Formatting the Unix Epoch*

```
import java.text.DateFormat;

import java.util.Date;
import java.util.Locale;
import java.util.TimeZone;

public class DateFormatDemo
{
    public static void main(String[] args)
    {
        Date d = new Date(0); // Unix epoch
        System.out.println(d);
        DateFormat df = DateFormat.getDateTimeInstance(DateFormat.LONG,
                                                         DateFormat.LONG,
                                                         Locale.US);
        System.out.println("Default format: " + df.format(d));
        df.setTimeZone(TimeZone.getTimeZone("UTC"));
        System.out.println("Taking UTC into account: " + df.format(d));
    }
}
```

Compile Listing 16-31 as follows:

```
javac DateFormatDemo.java
```

Run this application as follows:

```
java DateFormatDemo
```

I observe the following output for the CST time zone:

---

```
Wed Dec 31 18:00:00 CST 1969
Default format: December 31, 1969 6:00:00 PM CST
Taking UTC into account: January 1, 1970 12:00:00 AM UTC
```

---

The Unix epoch, which is represented by passing 0 to the `Date(long)` constructor, is defined as January 1, 1970 00:00:00 UTC, but the first output line doesn't indicate this fact. Instead, it shows the epoch in my CST time zone, which is six hours away from GMT/UTC. To show the epoch correctly, I need to obtain the UTC time zone, which I accomplish by passing "UTC" to `TimeZone`'s `getTimeZone(String)` class method and install this time zone instance into the date formatter with the help of `DateFormat`'s void `setTimeZone(TimeZone zone)` method.

**Note** When you need to create customized date formatters, you'll find yourself working with `DateFormat`'s `java.text.SimpleDateFormat` subclass and this subclass's `java.text.DateFormatSymbols` companion class. The "Customizing Formats" section (<http://download.oracle.com/javase/tutorial/i18n/format/simpleDateFormat.html>) and the "Changing Date Format Symbols" section (<http://download.oracle.com/javase/tutorial/i18n/format/dateFormatSymbols.html>) in *The Java Tutorials* introduce you to these classes.

## Message Formatters

Applications often display simple and/or compound status and error messages to the user. A *simple message* consists of static (unchanging) text, whereas a *compound message* consists of static text and variable (changeable) data. For example, consider the following compound messages, where the underlined text identifies variable data:

```
10,536 visitors have visited your website since June 16, 2010.
Warning: 25 files have been modified in a suspicious manner.
Account balance is $10,567.00!
```

For a simple message, you obtain its text from a resource bundle and then display this text to the user. For a compound message, you obtain a *pattern* (template) for the message from a property resource bundle, pass this pattern along with the variable data to a message formatter to create a simple message, and display this message's text.

A *message formatter* is an instance of the concrete `MessageFormat` class (a `Format` subclass). Unlike other APIs, `MessageFormat` doesn't have an abstract entry-point class with class methods for obtaining instances of subclasses. Instead, this class declares the following constructors:

- `MessageFormat(String pattern)` initializes a `MessageFormat` instance to the specified pattern and the default locale. This constructor throws `IllegalArgumentException` when pattern is invalid.
- `MessageFormat(String pattern, Locale locale)` initializes a `MessageFormat` instance to the specified pattern and locale. This constructor throws `IllegalArgumentException` when pattern is invalid.

A pattern consists of static text and placeholders for variable data. Each placeholder is a brace-delimited sequence of a zero-based integer identifier, an optional format type, and an optional format style. Examples include `{0}` (insert text between braces), `{1, date}` (insert a date in default style), and `{2, number, currency}` (insert a currency).

For example, the previous set of compound messages can be converted into Listing 16-32's patterns for the `en_US` locale.

*Listing 16-32. Patterns in an `example_en_US.properties` File*

```
p1 = {0, number, integer} visitors have visited your website since {1, date, long}.
p2 = Warning: {0, number, integer} files have been modified in a suspicious manner.
p3 = Account balance is {0, number, currency}!
```

The same placeholders can be used in equivalent compound messages localized to another locale, such as Listing 16-33's `fr_FR` locale.

*Listing 16-33. Patterns in an `example_fr_FR.properties` File*

```
p1 = {0, number, integer} visiteurs ont visité votre site Web depuis le {1, date, long}.
p2 = Avertissement : {0, number, integer} dossiers ont été modifiés d'une façon soupçonneuse.
p3 = L'équilibre de compte est {0, number, currency} !
```

**Note** An apostrophe (also known as a single quote) in a pattern starts a quoted string, in which, for example, `'{0, number, currency}'` is treated as a literal string and isn't interpreted as a placeholder by the formatter. To ensure that this placeholder isn't treated as a literal string in the previous example, `L'équilibre`'s single quote must be doubled, which is why `L''équilibre` appears.

After creating a `MessageFormat` instance, where the pattern is obtained from a resource bundle, you typically create an array of `Objects` and call `MessageFormat`'s inherited `String format(Object obj)` method (from `Format`) with this array; passing an array of `Objects` to a method whose parameter type is `Object` works because arrays are `Objects`.

When `format()` is called, it scans the pattern, replacing each placeholder with the corresponding entry in the `Objects` array. For example, when `format()` finds a placeholder with integer identifier 0, it causes the zeroth entry in the `Objects` array to be formatted and then the formatted results to be output.

**Tip** You might find `MessageFormat`'s `String format(String pattern, Object... arguments)` class method convenient for one-time formatting operations. This method is equivalent to executing `new MessageFormat(pattern).format(arguments, new StringBuffer(), null).toString()` on the default locale.

Listing 16-34 demonstrates message formatting in the context of the previous examples' properties files and their localized patterns.

*Listing 16-34. Formatting and Outputting Compound Messages According to the en\_US and fr\_FR Locales*

```
import java.text.MessageFormat;

import java.util.Calendar;
import java.util.Locale;
import java.util.ResourceBundle;

public class MessageFormatDemo
{
    public static void main(String[] args)
    {
        dumpMessages(Locale.US);
        System.out.println();
        dumpMessages(Locale.FRANCE);
    }

    static void dumpMessages(Locale locale)
    {
        ResourceBundle rb = ResourceBundle.getBundle("example", locale);
        MessageFormat mf = new MessageFormat(rb.getString("p1"), locale);
        Calendar cal = Calendar.getInstance(locale);
        cal.set(Calendar.YEAR, 2010);
        cal.set(Calendar.MONTH, Calendar.JUNE);
        cal.set(Calendar.DAY_OF_MONTH, 16);
        Object[] args = new Object[] { 10536, cal.getTime() };
        System.out.println(mf.format(args));
        mf.applyPattern(rb.getString("p2"));
        args = new Object[] { 25 };
        System.out.println(mf.format(args));
        mf.applyPattern(rb.getString("p3"));
        args = new Object[] { 10567.0 };
        System.out.println(mf.format(args));
    }
}
```

Listing 16-34 takes advantage of MessageFormat's void `applyPattern(String pattern)` method to override a previous pattern with a new pattern.

Compile Listing 16-34 as follows:

```
javac MessageFormatDemo.java
```

Run this application as follows:

```
java MessageFormatDemo
```

You should observe Figure 16-7's output, which I present via the Windows Notepad application.





```

out - Notepad
File Edit Format View Help
10,536 visitors have visited your website since June 16, 2010.
Warning: 25 files have been modified in a suspicious manner.
Account balance is $10,567.00!

10 536 visiteurs ont visité votre site web depuis le 16 juin 2010.
Avertissement : 25 dossiers ont été modifiés d'une façon soupçonneuse.
L'équilibre de compte est 10 567,00 € !

```

**Figure 16-7.** Windows Notepad reveals compound messages formatted for the `en_US` and `fr_FR` locales

If you observe an exception instead of this output, `example_en_US.properties` and `example_fr_FR.properties` are probably not in the same directory as `MessageFormatDemo`.

**Note** Some compound messages contain singular and plural words. For example, Logging 1 message to `x.log` and Logging 2 messages to `x.log` reveal singular and plural messages. Although you could specify pattern Logging {0} message(s) to {1}, it's not grammatically correct to state Logging 2 message(s) to `x.log`. The solution to this problem is to use the concrete `java.text.ChoiceFormat` class, a subclass of `NumberFormat` and a partner of `MessageFormat`, so that you can output Logging 1 message to `x.log` or Logging 2 messages to `x.log` depending on the numeric value passed to {0}. To learn how to use `ChoiceFormat`, check out the “Handling Plurals” section (<http://download.oracle.com/javase/tutorial/i18n/format/choiceFormat.html>) in *The Java Tutorials*.

## Parsing

The `Format` class has a dual personality in that it also declares a pair of `parseObject()` methods for parsing strings back into objects. Furthermore, it associates with a `java.text.ParseException` class whose instances are thrown when errors occur during parsing and a `java.text.ParsePosition` class that keeps track of the current parsing position and error position indexes.

**Note** `ParsePosition` declares `int getIndex()` and `void setIndex(int index)` methods for getting and setting the current parsing position, and it declares `int getErrorIndex()` and `void setErrorIndex(int index)` methods for getting and setting the current error position.

Format declares the following `parseObject()` methods:

- Object `parseObject(String source)` parses `source` from the beginning and returns a corresponding object. Not all of `source`'s text may be parsed. This method throws `ParseException` when the beginning of this text cannot be parsed.
- Object `parseObject(String source, ParsePosition pos)` parses `source` starting at the current parsing position index stored in `pos` and returns a corresponding object. When parsing succeeds, `pos`'s current parsing position index is updated to the index after the last character used (parsing doesn't necessarily use all characters up to the end of the string), and the parsed object is returned. The updated `pos` can be used to indicate the starting point for the next call to this method. When an error occurs, `pos`'s current parsing position index isn't changed. However, its error position index is set to the index of the character where the error occurred and null is returned. This method throws `NullPointerException` when null is passed to `pos`.

`parseObject(String)` invokes the abstract `parseObject(String, ParsePosition)` method as if by calling `parseObject(source, new ParsePosition(0))`.

Format subclasses such as `DateFormat` override `parseObject(String, ParsePosition)` to invoke one of their own `parse()` methods. For example, `MessageFormat` overrides `parseObject(String, ParsePosition)` and calls this method when necessary.

Although you should refrain from using specialty subclasses so that your application can adapt to the widest possible audience, you might find occasions to use such subclasses. For example, you might want to work directly with `SimpleDateFormat` to parse legacy date/time strings that were stored in a database according to a specific format. Listing 16-35 demonstrates how you might accomplish this task with help from `SimpleDateFormat`.

**Listing 16-35. Parsing a Date/Time Argument That Must be Formatted According to Specific Date Format**

```
import java.text.ParseException;
import java.text.SimpleDateFormat;

import java.util.Date;

public class ParseDemo
{
    public static void main(String[] args) throws ParseException
    {
        if (args.length != 1)
        {
            System.err.println("usage: java ParseDemo yyyy-MM-dd HH:mm:ss z");
            return;
        }
        SimpleDateFormat sdf;
        sdf = new SimpleDateFormat("yyyy-MM-dd HH:mm:ss z");
        System.out.println(sdf.parse(args[0]));
    }
}
```

Listing 16-35 first verifies that a single command-line argument was passed and then instantiates `SimpleDateFormat` with a pattern string that identifies the pattern to follow for parsing. (The complete details on pattern string syntax are available in `SimpleDateFormat`'s Java documentation.)

Compile Listing 16-35 as follows:

```
javac ParseDemo.java
```

Run this application as follows:

```
java ParseDemo "2014-01-04 11:21:00 CST"
```

On my platform, I observe the following output:

---

```
Sat Jan 04 11:21:00 CST 2014
```

---

## Focusing on Logging

In Chapter 5, I presented a simple logging framework to demonstrate packages. *Logging* is the recording of data while an application runs and is an important part of application development and maintenance. Messages are *logged* (captured as formatted records) to files or other destinations to help diagnose any problems that arise as an application executes.

Creating your own logging framework is typically a waste of time and you should use the standard `java.util.logging` package instead. This package implements Java's Logging API, which was introduced in Java 1.4. Oracle's documentation for `java.util.logging` states that there are four main uses for the *logs* (repositories of log entries) generated by the Logging API:

- *Problem diagnosis by end users and system administrators:* Basic information about common problems that can be fixed or tracked locally, such as running out of resources, security failures, and simple configuration errors, is logged for viewing by end users and system administrators.
- *Problem diagnosis by field service engineers:* The logging information used by field service engineers may be considerably more complex and verbose than that required by system administrators. Typically, such information will require extra logging within specific subsystems.
- *Problem diagnosis by the development organization:* When a problem occurs in the field, it may be necessary to return the captured logging information to the original development team for diagnosis. This logging information may be extremely detailed and fairly inscrutable. Such information might include detailed tracing on the internal execution of specific subsystems.
- *Problem diagnosis by developers:* The Logging API also may be used to help debug an application under development. This may include logging information generated by the target application as well as logging information generated by lower-level libraries. While this use is perfectly reasonable, the Logging API isn't intended to replace the normal debugging and profiling tools that may already exist in the development environment.

**Note** Android provides the `android.util.Log` class for logging messages, but you might prefer to use `java.util.logging` to maintain consistency between your Android and non-Android projects. To configure the Logging API for Android, check out [stackoverflow.com](http://stackoverflow.com/questions/4561345/how-to-configure-java-util-logging-on-android)'s "How to configure `java.util.logging` on Android?" topic (<http://stackoverflow.com/questions/4561345/how-to-configure-java-util-logging-on-android>).

## Logging API Overview

The `java.util.logging` package consists of 2 interfaces and 15 classes. This package's key types are described below:

- **Logger:** This class is the entry-point into the Logging API. It lets you log messages to various destinations such as files or the console.
- **LogRecord:** This class describes a message via a record and is used to pass messages between the logging framework and individual Handlers.
- **Handler:** This class receives messages from Logger and publishes them to a console, a file, a network logging service, and so on.
- **Level:** This class defines a set of standard log levels that can be used to control logging output.
- **Filter:** This interface provides fine-grain control over what is logged, beyond the control provided by log levels.
- **Formatter:** This class provides support for formatting LogRecords into strings.

Figure 16-8 shows the relationships among most of these types.

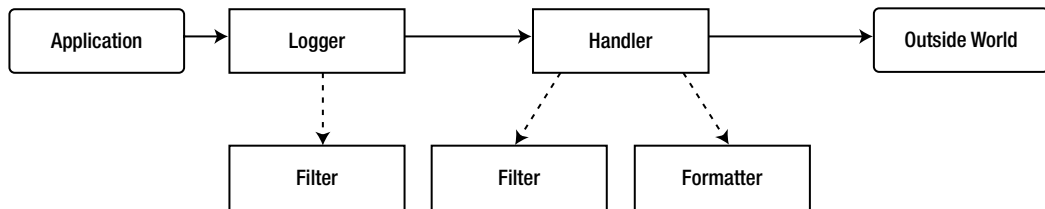

**Figure 16-8.** Relating the logging framework to an application and to the outside world

Applications make logging calls on Logger objects, which allocate LogRecord objects that are passed to Handler objects for publication. Loggers and Handlers may use log Levels and (optionally) Filters to decide if they're interested in a specific LogRecord. When it's necessary to publish a LogRecord externally, a Handler can use a Formatter to localize and format the message before publishing it to an I/O stream that sends the message to the outside world (the console, a file, or some other destination).

Each logged message is associated with a specific *log level*, which is an integer that indicates the message's relative importance. The higher the integer (level), the more important is the message. The `Level` class declares the following log levels:

- SEVERE: A message level indicating a serious failure. This is the highest value.
- WARNING: A message level indicating a potential problem.
- INFO: A message level for informational messages.
- CONFIG: A message level for static configuration messages.
- FINE: A message level providing tracing information.
- FINER: A fairly detailed tracing message.
- FINEST: A highly detailed tracing message.

**Note** There's also level ALL, which lets you log all records, and level OFF, which lets you turn off logging. It's also possible to define custom levels, which is beyond the scope of this chapter.

As you move down the list, the amount of logged information increases. It takes time to record all of this information, and accumulated logging time can impact your application's performance. For this reason, the Logging API defaults to logging only those messages at the `Level.INFO` level or higher.

## A Hierarchy of Loggers

An application that uses the Logging API typically first obtains a `Logger` instance (logger). `Logger` declares several `getLogger()` and `getAnonymousLogger()` class methods for this task. The `getLogger()` methods return loggers that are associated with names and the `getAnonymousLogger()` methods return loggers that have no names.

Loggers are normally named and this name, which typically consists of several dot-separated names (think of a package name), describes a namespace. Each dot-separated name identifies a separate logger in a hierarchy of related loggers. The following example obtains a named logger by calling `Logger.getLogger(String name)`:

```
Logger logger = Logger.getLogger("simpleLogger");
```

The string passed to `getLogger()` names the logger, which happens to be `simpleLogger` in the example.

**Note** `Logger` declares a `String getName()` method that returns a logger's name or null for anonymous loggers.

`simpleLogger` exists in a hierarchy consisting of two loggers:

```
""
simpleLogger
```

Here, `""` identifies the *root logger*, which is an automatically created logger at the top of the hierarchy. The root logger is the *parent logger* and `simpleLogger` is the *child logger* of this parent.

You will often pass a dot-separated name to `getLogger()`, as follows:

```
Logger logger = Logger.getLogger("ca.tutortutor.app");
```

The logger associated with `ca.tutortutor.app` exists in a potential hierarchy of four loggers:

```
""
ca
ca.tutortutor
ca.tutortutor.app
```

At this point, only the root logger and the logger associated with `ca.tutortutor.app` exist. The other two loggers don't automatically come into existence and must be explicitly created, as follows:

```
Logger logger1 = Logger.getLogger("ca");
Logger logger2 = Logger.getLogger("ca.tutortutor");
Logger logger3 = Logger.getLogger("ca.tutortutor.app");
```

What's the point of having separate loggers? The answer is flexibility. Given these loggers, you could log messages separately based on their locations in the namespace. For example, all messages logged via `logger1` could be sent to the console, all messages logged via `logger2` could be stored in a file, and so on.

Figure 16-9 shows the resulting hierarchy.

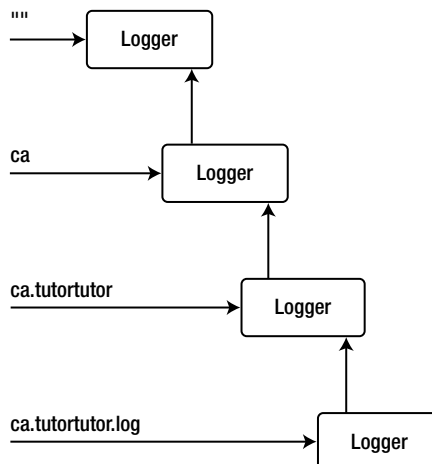

**Figure 16-9.** A hierarchy of loggers

Logger declares a `Logger getParent()` method that returns the nearest parent of the logger on which this method is invoked. For example, `logger2.getParent()` returns `logger1`. When `getParent()` is called on the root logger, this method returns null. If a logger hasn't been created, the next highest parent is returned. For example, `Logger.getLogger("a.b").getParent()` returns the root logger.

## Logging Messages

Logger provides methods for sending messages to handlers. By default, a logger also sends its output to its parent logger. Logger declares the following method categories for logging messages:

- The `log()` methods let you log messages at specific log levels. For example, `void log(Level logLevel, String msg)` logs the message identified by `msg` at the specified level. The message is transmitted to all subscribed handlers.
- The `logp()` methods build onto the `log()` methods by adding `String`-based `sourceClass` and `sourceMethod` parameters, which identify the class and method that was the source of the message. For example, `void logp(Level logLevel, String sourceClass, String sourceMethod, String msg)` is equivalent to the previous `log()` method except for these additional parameters.
- The `logrb()` methods are also similar to the `log()` methods. However, they can obtain localized messages from resource bundles, which I discussed earlier in this chapter. For example, `void logrb(Level logLevel, String sourceClass, String sourceMethod, String bundleName, String msg)` is equivalent to the previous `logp()` method except that a localized variant of `msg` is logged.
- The miscellaneous category declares additional methods that include the following methods:
  - `void entering(String sourceClass, String sourceMethod)`: Log a message indicating that a method has been entered. A log record with log level `Level.FINER`, message `ENTRY`, the specified source class name, and the specified source method name is submitted for logging.
  - `void exiting(String sourceClass, String sourceMethod)`: Log a message indicating that a method has exited. A log record with log level `Level.FINER`, message `RETURN`, the specified source class name, and the specified source method name is submitted for logging.
  - `void finest(String msg)`: Log a message of level `Level.FINEST`; the message is transmitted to all subscribed handlers.
  - `void info(String msg)`: Log a message of level `Level.INFO`; the message is transmitted to all subscribed handlers.

Listing 16-36 presents an application that demonstrates `void log(Level logLevel, String msg)`.

*Listing 16-36. Logging a Loop of Integers*

```
import java.util.logging.Level;
import java.util.logging.Logger;

public class LoggingDemo
{
    public static void main(String[] args)
    {
        Logger logger = Logger.getLogger("LoggingDemo");
        for (int i = 0; i < 5; i++)
            logger.log(Level.INFO, i+"");
    }
}
```

Listing 16-36's `main()` method first obtains a logger named `LoggingDemo` and then enters a for loop. Each loop iteration invokes the logger's `log()` method with the `INFO` level and the current value of `i`.

**Note** It's common to choose a package name and a class name for the logger's name. For example, in Listing 16-36, I chose `LoggingDemo` as this name because it corresponds to the `LoggingDemo` class name, which exists in the unnamed package (no package statement).

Compile Listing 16-36 as follows:

```
javac LoggingDemo.java
```

Run this application as follows:

```
java LoggingDemo
```

You should observe output similar to that shown below:

---

```
Jan 06, 2014 8:36:08 PM LoggingDemo main
INFO: 0
Jan 06, 2014 8:36:08 PM LoggingDemo main
INFO: 1
Jan 06, 2014 8:36:08 PM LoggingDemo main
INFO: 2
Jan 06, 2014 8:36:08 PM LoggingDemo main
INFO: 3
Jan 06, 2014 8:36:08 PM LoggingDemo main
INFO: 4
```

---

This output is sent to the default console handler that forwards the messages to the standard error stream. Notice the word `INFO`, which indicates that the logged message is an informational message.



Listing 16-37 presents an application that demonstrates `void logp(Level logLevel, String sourceClass, String sourceMethod, String msg)`.

*Listing 16-37. Logging a Loop of Integers Along with Class and Method Names*

```
import java.util.logging.Level;
import java.util.logging.Logger;

public class LoggingDemo
{
    public static void main(String[] args)
    {
        Logger logger = Logger.getLogger("LoggingDemo");
        for (int i = 0; i < 5; i++)
            logger.logp(Level.INFO, "LoggingDemo", "main", i+"");
    }
}
```

Compile Listing 16-37 (`javac LoggingDemo.java`) and run the application (`java LoggingDemo`). You should observe output similar to the following output:

---

```
Jan 06, 2014 8:42:52 PM LoggingDemo main
INFO: 0
Jan 06, 2014 8:42:52 PM LoggingDemo main
INFO: 1
Jan 06, 2014 8:42:52 PM LoggingDemo main
INFO: 2
Jan 06, 2014 8:42:52 PM LoggingDemo main
INFO: 3
Jan 06, 2014 8:42:52 PM LoggingDemo main
INFO: 4
```

---

Listing 16-38 presents an application that demonstrates `void logrb(Level logLevel, String sourceClass, String sourceMethod, String bundleName, String msg)`.

*Listing 16-38. Logging a Localized France Message Along with Class and Method Names*

```
import java.util.Locale;

import java.util.logging.Level;
import java.util.logging.Logger;

public class LoggingDemo
{
    public static void main(String[] args)
    {
        Locale.setDefault(Locale.FRANCE);
        Logger logger = Logger.getLogger("LoggingDemo");
        logger.logrb(Level.INFO, "LoggingDemo", "main", "msg", "hello");
    }
}
```

Listing 16-38's `main()` method first sets the default locale to `Locale.FRANCE`. It then obtains a logger and invokes `logrb()` on this logger to log the localized FRANCE equivalent of the hello message. The equivalent text is stored in a resource bundle named `msg_fr_FR.properties`, whose contents are presented in Listing 16-39.

**Listing 16-39. Storing FRANCE Locale Equivalent Text for the Hello Message**

```
hello=Bonjour
```

Compile Listing 16-38 (`javac LoggingDemo.java`) and run the application (`java LoggingDemo`). You should observe localized output similar to the following output:

---

```
janv. 06, 2014 11:30:54 PM LoggingDemo main
INFO: Bonjour
```

---

Listing 16-40 presents an application that demonstrates `void entering(String sourceClass, String sourceMethod)` and `void exiting(String sourceClass, String sourceMethod)`.

**Listing 16-40. Logging a Recursive factorial() Method's Entry and Exit**

```
import java.util.logging.Logger;

public class LoggingDemo
{
    static Logger logger = Logger.getLogger("LoggingDemo");

    public static void main(String[] args)
    {
        System.out.println(factorial(5));
    }

    static int factorial(int n)
    {
        logger.entering("LoggingDemo", "factorial");
        if (n == 0 || n == 1)
        {
            logger.exiting("LoggingDemo", "factorial");
            return 1;
        }
        else
        {
            logger.exiting("LoggingDemo", "factorial");
            return n*factorial(n-1);
        }
    }
}
```

Listing 16-40's `main()` method calculates and outputs 5 factorial, which equals 120. This method logs messages upon entry to and exit from the recursive `factorial()` method.

Compile Listing 16-40 (`javac LoggingDemo.java`) and run the application (`java LoggingDemo`). You will probably be surprised to discover no logging messages.

No logging messages are output because the logger defaults to not outputting messages whose log levels are less than `Level.INFO`, the default console handler doesn't publish messages whose log levels are less than `Level.INFO`, and the `entering()` and `exiting()` methods log messages whose log levels are set to `Level.FINER`, which is less than `Level.INFO`.

The solution to this problem is to change the logger and handler log levels to `Level.FINER`. Listing 16-41 shows how to accomplish this task.

*Listing 16-41. Changing Logger and Handler Levels to Observe Entry and Exit Messages*

```
import java.util.logging.Handler;
import java.util.logging.Level;
import java.util.logging.Logger;

public class LoggingDemo
{
    static Logger logger = Logger.getLogger("LoggingDemo");

    public static void main(String[] args)
    {
        logger.setLevel(Level.FINER);
        Handler[] handlers = Logger.getLogger("").getHandlers();
        for (Handler handler: handlers)
            handler.setLevel(Level.FINER);
        System.out.println(factorial(5));
    }

    static int factorial(int n)
    {
        logger.entering("LoggingDemo", "factorial");
        if (n == 0 || n == 1)
        {
            logger.exiting("LoggingDemo", "factorial");
            return 1;
        }
        else
        {
            logger.exiting("LoggingDemo", "factorial");
            return n*factorial(n-1);
        }
    }
}
```

Listing 16-41 uses `Logger`'s void `setLevel(Level newLevel)` and `Handler[] getHandlers()` methods to change respectively the invoking logger's log level to `Level.FINER` and obtain an array of handlers associated with the root logger (`""`). For each returned handler (the root logger provides a console handler only), `Handler`'s void `setLevel(Level newLevel)` method is called to set the handler's log level to `Level.FINER`.

Compile Listing 16-41 (`javac LoggingDemo.java`) and run the application (`java LoggingDemo`). This time, you should observe more complete output:

---

```
Jan 06, 2014 11:32:28 PM LoggingDemo factorial
FINER: ENTRY
Jan 06, 2014 11:32:28 PM LoggingDemo factorial
FINER: RETURN
Jan 06, 2014 11:32:28 PM LoggingDemo factorial
FINER: ENTRY
Jan 06, 2014 11:32:28 PM LoggingDemo factorial
FINER: RETURN
Jan 06, 2014 11:32:28 PM LoggingDemo factorial
FINER: ENTRY
Jan 06, 2014 11:32:28 PM LoggingDemo factorial
FINER: RETURN
Jan 06, 2014 11:32:28 PM LoggingDemo factorial
FINER: ENTRY
Jan 06, 2014 11:32:28 PM LoggingDemo factorial
FINER: RETURN
Jan 06, 2014 11:32:28 PM LoggingDemo factorial
FINER: ENTRY
Jan 06, 2014 11:32:28 PM LoggingDemo factorial
FINER: RETURN
120
```

---

The previous example placed `entering()` and `exiting()` method calls in a recursive method to log method entry and exit. You can also log thrown exceptions from within a catch block via various `Logger` methods that take `java.lang.Throwable` arguments. For example, `void log(Level logLevel, String msg, Throwable thrown)` is equivalent to `void log(Level logLevel, String msg)` except that it also lets you log an exception, more specifically, a `Throwable` (an exception or error). Listing 16-42 demonstrates this method.

**Listing 16-42. Logging a Thrown Exception**

```
import java.io.FileInputStream;
import java.io.FileNotFoundException;
import java.io.IOException;

import java.util.logging.Level;
import java.util.logging.Logger;

public class LoggingDemo
{
    public static void main(String[] args)
    {
        if (args.length != 1)
        {
            System.err.println("usage: java LoggingDemo filespec");
            return;
        }
    }
}
```

```

    Logger logger = Logger.getLogger("LoggingDemo");
    FileInputStream fis = null;
    try
    {
        fis = new FileInputStream(args[0]);
    }
    catch (FileNotFoundException fnfe)
    {
        logger.log(Level.INFO, "file not found", fnfe);
    }
    finally
    {
        if (fis != null)
            try
            {
                fis.close();
            }
            catch (IOException ioe)
            {
            }
        }
    }
}

```

Listing 16-42's `main()` method first verifies that a single command-line argument has been specified. This argument names a file to be opened. After creating a logger, `main()` attempts to open this file. If `java.io.FileNotFoundException` is thrown, this exception is logged from within the catch block.

Compile Listing 16-42 (`javac LoggingDemo.java`), and run the application with a nonexistent file, as follows:

```
java LoggingDemo x.dat
```

You should observe output that's similar to the following output:

---

```

Jan 07, 2014 11:04:52 AM LoggingDemo main
INFO: file not found
java.io.FileNotFoundException: x.dat (The system cannot find the file specified)
    at java.io.FileInputStream.open(Native Method)
    at java.io.FileInputStream.<init>(FileInputStream.java:138)
    at java.io.FileInputStream.<init>(FileInputStream.java:97)
    at LoggingDemo.main(LoggingDemo.java:21)

```

---

## Filtering LogRecords

Log levels are a kind of filter that let you categorize messages according to their level of importance and the amount of detail to be presented. The Logging API also provides a more generic filtering mechanism based on the `Filter` interface that lets you further filter messages regardless of their log levels.

Filter declares a single method:

```
boolean isLoggable(LogRecord record)
```

The `isLoggable()` method receives a `LogRecord` argument, examines this argument to determine whether or not it should be logged, and returns `true` when the record should be logged or `false` when the record shouldn't be logged. Creating a filter is simply a matter of declaring a class that implements `Filter` and its `isLoggable()` method.

`LogRecord` declares various getters and setters for accessing and modifying the record. You will typically only use getters to interrogate the record to learn whether it should be logged or not.

A few useful getters are described here:

- `Level getLevel()`: Returns the record's log level.
- `String getLoggerName()`: Returns the record's logger name.
- `String getMessage()`: Returns the record's raw message, which might be null.
- `long getMillis()`: Returns the time (in milliseconds since 1970) when this record was created.
- `String getSourceMethodName()`: Returns the record's name of the method that's the source of this record.

Listing 16-43 declares a `SimpleFilter` class that uses `getSourceMethodName()` to detect the `main()` method and accepts records originating from this method only.

*Listing 16-43. Declaring a Filter That Accepts Records from the main() Method Only*

```
import java.util.logging.Filter;
import java.util.logging.LogRecord;

public class SimpleFilter implements Filter
{
    @Override
    public boolean isLoggable(LogRecord record)
    {
        return (record.getSourceMethodName().equals("main")) ? true : false;
    }
}
```

`Logger` declares a `void setFilter(Filter newFilter)` method for installing a filter on the current logger. Passing `null` to `newFilter` uninstalls the filter. A companion `Filter getFilter()` method returns the current filter or `null` when there is none.

**Note** You can also install filters on handlers. `Handler` declares identical `void setFilter(Filter newFilter)` and `Filter getFilter()` methods.

Listing 16-44 declares a `LoggingDemo` class that demonstrates the use of `SimpleFilter`.

*Listing 16-44. Filtering Records from `main()` and a Companion Method*

```
import java.util.logging.Level;
import java.util.logging.Logger;

public class LoggingDemo
{
    public static void main(String[] args)
    {
        Logger logger = Logger.getLogger("LoggingDemo");
        logger.setFilter(new SimpleFilter());
        logger.log(Level.INFO, "Message 1");
        logger.log(Level.INFO, "Message 2");
        foo(logger);
        System.out.println();
        logger.setFilter(null);
        foo(logger);
    }

    static void foo(Logger logger)
    {
        logger.log(Level.INFO, "Message 3");
    }
}
```

Listing 16-44's `main()` method first obtains a logger and installs an instance of `SimpleFilter` on this logger. It then logs a couple of informational messages and invokes a companion `foo()` method with the logger as its argument; this method logs a third informational message. The filter is then removed and `foo()` is called one more time.

Compile Listing 16-44 (`javac LoggingDemo.java`), which also compiles `SimpleFilter.java` (assuming that it's located in the same directory), and run the application (`java LoggingDemo`). You should observe output that's similar to the following output:

---

```
Jan 07, 2014 12:08:26 PM LoggingDemo main
INFO: Message 1
Jan 07, 2014 12:08:26 PM LoggingDemo main
INFO: Message 2

Jan 07, 2014 12:08:26 PM LoggingDemo foo
INFO: Message 3
```

---

The message logged in the `foo()` method isn't written to the console when the `SimpleFilter` instance is installed. It's written only when this filter is removed.

## Handlers and Formatters

Loggers send log records to handlers, which are instances of classes that extend the abstract `Handler` class. These handler instances publish records to various destinations when their concrete implementations of `Handler`'s void `publish(LogRecord record)` method are called by the logging framework.

The Logging API provides several concrete implementations of the `Handler` class:

- `ConsoleHandler`: A handler that writes log records to the standard error stream.
- `FileHandler`: A handler that writes log records to a file or to a rotating set of files.
- `MemoryHandler`: A handler that writes log records to a cycled memory buffer.
- `SocketHandler`: A handler that writes log records to a socket.
- `StreamHandler`: A handler that writes log records to an output stream.

**Note** If none of these handlers meet your needs, you can always extend `Handler` and define your own handler class.

Every logger has at least a default console handler. You can add more handlers to, remove existing handlers from, and query all currently registered handlers on a logger by invoking the following `Logger` methods:

- `void addHandler(Handler handler)`: Adds the specified handler to the invoking logger.
- `void removeHandler(Handler handler)`: Removes the specified handler from the invoking logger. This method returns silently when the handler isn't found or `null` is passed.
- `Handler[] getHandlers()`: Returns an array of all handlers registered with the invoking logger.

Listing 16-45 extends Listing 16-36 by also adding a file handler as a destination for logged messages.

*Listing 16-45. Logging Messages to the Standard Error Stream and to a File*

```
import java.io.IOException;

import java.util.logging.FileHandler;
import java.util.logging.Level;
import java.util.logging.Logger;
```



```

public class LoggingDemo
{
    public static void main(String[] args) throws IOException
    {
        Logger logger = Logger.getLogger("LoggingDemo");
        logger.addHandler(new FileHandler("log"));
        for (int i = 0; i < 5; i++)
            logger.log(Level.INFO, i+"");
    }
}

```

Listing 16-45's `main()` method instantiates `FileHandler` by invoking its `FileHandler(String pattern)` constructor. The argument passed to `pattern` is the name of the file to which logged messages are written. Because this constructor can throw `IOException`, I've appended a `throws IOException` clause to `main()`'s header.

Continuing, the file handler is added to the logger and various messages are logged.

**Note** `FileHandler` declares a `void close()` method for closing all files associated with the file handler. You would typically invoke this method after logging to the file handler in a long-running application. For a trivial application, such as that shown in Listing 16-45 in which the file is closed when the application exits, it isn't essential to call `close()`.

Compile Listing 16-45 (`javac LoggingDemo.java`) and run the application (`java LoggingDemo`). In addition to observing logging information on the console, you should also observe the creation of a file named `log` that stores the output. This file's content contains the following:

```

<?xml version="1.0" encoding="windows-1252" standalone="no"?>
<!DOCTYPE log SYSTEM "logger.dtd">
<log>
<record>
  <date>2014-01-07T13:13:16</date>
  <millis>1389121996785</millis>
  <sequence>0</sequence>
  <logger>LoggingDemo</logger>
  <level>INFO</level>
  <class>LoggingDemo</class>
  <method>main</method>
  <thread>1</thread>
  <message>0</message>
</record>
<record>
  <date>2014-01-07T13:13:16</date>
  <millis>1389121996815</millis>
  <sequence>1</sequence>
  <logger>LoggingDemo</logger>
  <level>INFO</level>

```

```

<class>LoggingDemo</class>
<method>main</method>
<thread>1</thread>
<message>1</message>
</record>
<record>
  <date>2014-01-07T13:13:16</date>
  <millis>1389121996825</millis>
  <sequence>2</sequence>
  <logger>LoggingDemo</logger>
  <level>INFO</level>
  <class>LoggingDemo</class>
  <method>main</method>
  <thread>1</thread>
  <message>2</message>
</record>
<record>
  <date>2014-01-07T13:13:16</date>
  <millis>1389121996825</millis>
  <sequence>3</sequence>
  <logger>LoggingDemo</logger>
  <level>INFO</level>
  <class>LoggingDemo</class>
  <method>main</method>
  <thread>1</thread>
  <message>3</message>
</record>
<record>
  <date>2014-01-07T13:13:16</date>
  <millis>1389121996825</millis>
  <sequence>4</sequence>
  <logger>LoggingDemo</logger>
  <level>INFO</level>
  <class>LoggingDemo</class>
  <method>main</method>
  <thread>1</thread>
  <message>4</message>
</record>
</log>

```

This formatted output was created by an instance of the `XMLFormatter` class, which is a concrete subclass of its abstract `Formatter` superclass. `Formatter` objects convert `LogRecords` to string representations, and `XMLFormatter` converts `LogRecords` to XML string representations.

**Note** The `java.util.logging` package also offers `SimpleFormatter` as a concrete `Formatter` subclass.

Formatters are associated with handlers. Handler declares `void setFormatter(Formatter newFormatter)` for setting the invoking handler's formatter to `newFormatter` and a companion `Formatter getFormatter()` method for returning the current formatter.

You can use this knowledge to change the formatter assigned to the previous `FileHandler` object from an XML formatter to a simple formatter. Listing 16-46 demonstrates this change.

*Listing 16-46. Logging Simple Formatted Messages to the Standard Error Stream and to a File*

```
import java.io.IOException;

import java.util.logging.FileHandler;
import java.util.logging.Level;
import java.util.logging.Logger;
import java.util.logging.SimpleFormatter;

public class LoggingDemo
{
    public static void main(String[] args) throws IOException
    {
        Logger logger = Logger.getLogger("LoggingDemo");
        FileHandler fh = new FileHandler("log");
        fh.setFormatter(new SimpleFormatter());
        logger.addHandler(fh);
        for (int i = 0; i < 5; i++)
            logger.log(Level.INFO, i+"");
    }
}
```

Compile Listing 16-46 (`javac LoggingDemo.java`) and run the application (`java LoggingDemo`). In addition to observing logging information on the console, you should also observe the creation of a file named `log` that stores the output. This file's simple formatted content appears as follows:

---

```
Jan 07, 2014 1:22:05 PM LoggingDemo main
INFO: 0
Jan 07, 2014 1:22:05 PM LoggingDemo main
INFO: 1
Jan 07, 2014 1:22:05 PM LoggingDemo main
INFO: 2
Jan 07, 2014 1:22:05 PM LoggingDemo main
INFO: 3
Jan 07, 2014 1:22:05 PM LoggingDemo main
INFO: 4
```

---

## LogManager and Configuration

The `java.util.logging` package includes a `LogManager` class that's used to manage a hierarchical namespace of all named `Logger` objects and to maintain configuration properties of the logging framework. Although you will typically not need to work with `LogManager`, you may want to do so to reload configuration information or to perform another global task.

The virtual machine includes a single log manager, which you obtain by invoking LogManager's `LogManager.getLogManager()` class method, as follows:

```
LogManager lm = LogManager.getLogManager();
```

You can then invoke a LogManager method such as `void readConfiguration()` to reinitialize the log manager's properties and configuration.

The Logging API has a default configuration file named `logging.properties` that's stored in the JDK's `%JAVA_HOME%/jre/lib` directory. This properties file provides default settings such as the default global log level and the default log level for all console handlers. Listing 16-47 presents this file's contents for JDK 7 Update 6.

*Listing 16-47. The Default Logging Configuration File*

```
#####
#       Default Logging Configuration File
#
# You can use a different file by specifying a filename
# with the java.util.logging.config.file system property.
# For example java -Djava.util.logging.config.file=myfile
#####

#####
#       Global properties
#####

# "handlers" specifies a comma separated list of log Handler
# classes. These handlers will be installed during VM startup.
# Note that these classes must be on the system classpath.
# By default we only configure a ConsoleHandler, which will only
# show messages at the INFO and above levels.
handlers= java.util.logging.ConsoleHandler

# To also add the FileHandler, use the following line instead.
#handlers= java.util.logging.FileHandler, java.util.logging.ConsoleHandler

# Default global logging level.
# This specifies which kinds of events are logged across
# all loggers. For any given facility this global level
# can be overridden by a facility specific level
# Note that the ConsoleHandler also has a separate level
# setting to limit messages printed to the console.
.level= INFO

#####
# Handler specific properties.
# Describes specific configuration info for Handlers.
#####

# default file output is in user's home directory.
java.util.logging.FileHandler.pattern = %h/java%u.log
java.util.logging.FileHandler.limit = 50000
```

```

java.util.logging.FileHandler.count = 1
java.util.logging.FileHandler.formatter = java.util.logging.XMLFormatter

# Limit the message that are printed on the console to INFO and above.
java.util.logging.ConsoleHandler.level = INFO
java.util.logging.ConsoleHandler.formatter = java.util.logging.SimpleFormatter

# Example to customize the SimpleFormatter output format
# to print one-line log message like this:
#   <level>: <log message> [<date/time>]
#
# java.util.logging.SimpleFormatter.format=%4$s: %5$s [%1$tc]%n

#####
# Facility specific properties.
# Provides extra control for each logger.
#####

# For example, set the com.xyz.foo logger to only log SEVERE
# messages:
com.xyz.foo.level = SEVERE

```

You might prefer to change the default configuration. Instead of modifying the JDK's `logging.properties` file, you should create a separate configuration file and set the virtual machine's `java.util.logging.config.file` system property to point to this file.

For example, let's create a `mylogging.properties` file that's identical to `logging.properties` with two exceptions:

- The global logging level is changed to `FINEST` by replacing `.level= INFO` with `.level=FINEST`.
- The console handler level is changed to `FINEST` by replacing `java.util.logging.ConsoleHandler.level = INFO` with `java.util.logging.ConsoleHandler.level = FINEST`.

Also, you need a `LoggingDemo` application that logs its messages using the `FINEST` log level. Listing 16-48 presents this application.

*Listing 16-48. Logging a Loop of Integers Revisited*

```

import java.util.logging.Level;
import java.util.logging.Logger;

public class LoggingDemo
{
    public static void main(String[] args)
    {
        Logger logger = Logger.getLogger("LoggingDemo");
        for (int i = 0; i < 5; i++)
            logger.log(Level.FINE, i+"");
    }
}

```

Compile Listing 16-48 (`javac LoggingDemo.java`), and run the application (`java LoggingDemo`). You should not observe any output.

Now, re-execute the application via the following command line:

```
java -Djava.util.logging.config.file=mylogging.properties LoggingDemo
```

This time, you should observe the following output:

---

```
Jan 07, 2014 3:48:27 PM LoggingDemo main
FINE: 0
Jan 07, 2014 3:48:27 PM LoggingDemo main
FINE: 1
Jan 07, 2014 3:48:27 PM LoggingDemo main
FINE: 2
Jan 07, 2014 3:48:27 PM LoggingDemo main
FINE: 3
Jan 07, 2014 3:48:27 PM LoggingDemo main
FINE: 4
```

---

## ErrorManager

The Logging API's logging methods never throw exceptions; it would be burdensome to force developers to wrap all of their logging calls in try/catch constructs. Besides, how would the application recover from an exception in the logging framework? Because Handler classes such as `FileHandler` and `StreamHandler` can experience I/O exceptions, the Logging API provides the `ErrorManager` class so that a handler can report an exception instead of discarding it.

Each Handler subclass instance has an associated `ErrorManager`/`ErrorManager` subclass instance. When an exception occurs in the handler, it passes the exception as well as a message and an error code (discussed shortly) to the following method:

```
void error(String msg, Exception ex, int code)
```

The argument passed to `msg` is a descriptive string of the error; it may be `null`. The argument passed to `ex` identifies the exception that was thrown; it may be `null`. Finally, the argument passed to `code` is one of the following error code constants declared by `ErrorManager`:

- `CLOSE_FAILURE`: An output stream couldn't be closed.
- `FLUSH_FAILURE`: An output stream couldn't be flushed.
- `FORMAT_FAILURE`: A formatting operation failed.
- `GENERIC_FAILURE`: The failure doesn't fit into any of the other categories.
- `OPEN_FAILURE`: An output stream couldn't be opened.
- `WRITE_FAILURE`: An output stream couldn't be written.

`ErrorManager`'s `error()` method writes a message that describes the exception to `System.err`. However, it only does this the first time it's called. The logging framework assumes that a handler that throws an exception will continue to throw the same exception with each subsequently logged message. It's not useful to keep sending repeated exception messages to `System.err`.

Listing 16-49 presents a `LoggingDemo` application that demonstrates the default error manager.

*Listing 16-49. Generating an Error by Prematurely Closing the Output Stream*

```
import java.io.FileOutputStream;
import java.io.IOException;

import java.util.logging.ErrorManager;
import java.util.logging.Level;
import java.util.logging.Logger;
import java.util.logging.SimpleFormatter;
import java.util.logging.StreamHandler;

public class LoggingDemo
{
    public static void main(String[] args) throws IOException
    {
        Logger logger = Logger.getLogger("LoggingDemo");
        FileOutputStream fos = new FileOutputStream("log");
        StreamHandler sh = new StreamHandler(fos, new SimpleFormatter());
        logger.addHandler(sh);
        for (int i = 0; i < 5; i++)
        {
            logger.log(Level.INFO, i+"");
            if (i == 0)
                fos.close();
        }
    }
}
```

Listing 16-49's `main()` method first obtains a logger and then creates an output stream to a file named `log`. Next, it creates a `StreamHandler` instance connected to this file output stream and a simple formatter. The stream handler is then added to the logger.

`main()` now enters the for loop and logs an informational message to the output stream. After logging this message, it closes the output stream and starts another for loop iteration. The next call to the `log()` method results in an error, specifically a thrown exception.

Compile Listing 16-49 (`javac LoggingDemo.java`) and run the application (`java LoggingDemo`). You should observe the following output:

---

```
Jan 07, 2014 11:19:48 PM LoggingDemo main
INFO: 0
Jan 07, 2014 11:19:48 PM LoggingDemo main
INFO: 1
Jan 07, 2014 11:19:48 PM LoggingDemo main
INFO: 2
Jan 07, 2014 11:19:48 PM LoggingDemo main
INFO: 3
Jan 07, 2014 11:19:48 PM LoggingDemo main
INFO: 4
java.util.logging.ErrorManager: 3
java.io.IOException: Stream Closed
    at java.io.FileOutputStream.writeBytes(Native Method)
    at java.io.FileOutputStream.write(FileOutputStream.java:318)
    at sun.nio.cs.StreamEncoder.writeBytes(StreamEncoder.java:221)
    at sun.nio.cs.StreamEncoder.implFlushBuffer(StreamEncoder.java:291)
    at sun.nio.cs.StreamEncoder.implFlush(StreamEncoder.java:295)
    at sun.nio.cs.StreamEncoder.flush(StreamEncoder.java:141)
    at java.io.OutputStreamWriter.flush(OutputStreamWriter.java:229)
    at java.util.logging.StreamHandler.flushAndClose(StreamHandler.java:260)
    at java.util.logging.StreamHandler.close(StreamHandler.java:284)
    at java.util.logging.LogManager.resetLogger(LogManager.java:860)
    at java.util.logging.LogManager.reset(LogManager.java:843)
    at java.util.logging.LogManager$Cleaner.run(LogManager.java:240)
```

---

The default error manager identifies the cause of the thrown `IOException`, which happens to be that the output stream was prematurely closed while logging was still in progress.

You can subclass `ErrorManager` to customize the error reporting and install it on the handler by passing an instance to Handler's void `setErrorHandler(ErrorManager em)` method. A companion `ErrorManager` `getErrorHandler()` method returns the current error manager.

Listing 16-50 extends Listing 16-49 by installing a custom error manager.

*Listing 16-50. Customized Error Output from a Prematurely Closed Output Stream*

```
import java.io.FileOutputStream;
import java.io.IOException;

import java.util.logging.ErrorManager;
import java.util.logging.Level;
import java.util.logging.Logger;
import java.util.logging.SimpleFormatter;
import java.util.logging.StreamHandler;
```



```

public class LoggingDemo
{
    public static void main(String[] args) throws IOException
    {
        Logger logger = Logger.getLogger("LoggingDemo");
        FileOutputStream fos = new FileOutputStream("log");
        StreamHandler sh = new StreamHandler(fos, new SimpleFormatter());
        sh.setErrorManager(new MyErrorManager());
        logger.addHandler(sh);
        for (int i = 0; i < 5; i++)
        {
            logger.log(Level.INFO, i+"");
            if (i == 0)
                fos.close();
        }
    }
}

class MyErrorManager extends ErrorManager
{
    @Override
    public void error(String msg, Exception ex, int code)
    {
        System.err.println("=====");
        super.error(msg, ex, code);
        System.err.println("=====");
    }
}

```

Compile Listing 16-50 (`javac LoggingDemo.java`) and run the application (`java LoggingDemo`). You should observe the following output:

---

```

Jan 08, 2014 7:14:14 PM LoggingDemo main
INFO: 0
Jan 08, 2014 7:14:14 PM LoggingDemo main
INFO: 1
Jan 08, 2014 7:14:14 PM LoggingDemo main
INFO: 2
Jan 08, 2014 7:14:14 PM LoggingDemo main
INFO: 3
Jan 08, 2014 7:14:14 PM LoggingDemo main
INFO: 4
=====
java.util.logging.ErrorManager: 3
java.io.IOException: Stream Closed
    at java.io.FileOutputStream.writeBytes(Native Method)
    at java.io.FileOutputStream.write(FileOutputStream.java:318)
    at sun.nio.cs.StreamEncoder.writeBytes(StreamEncoder.java:221)
    at sun.nio.cs.StreamEncoder.implFlushBuffer(StreamEncoder.java:291)
    at sun.nio.cs.StreamEncoder.implFlush(StreamEncoder.java:295)
    at sun.nio.cs.StreamEncoder.flush(StreamEncoder.java:141)

```

```

at java.io.OutputStreamWriter.flush(OutputStreamWriter.java:229)
at java.util.logging.StreamHandler.flushAndClose(StreamHandler.java:260)
at java.util.logging.StreamHandler.close(StreamHandler.java:284)
at java.util.logging.LogManager.resetLogger(LogManager.java:860)
at java.util.logging.LogManager.reset(LogManager.java:843)
at java.util.logging.LogManager$Cleaner.run(LogManager.java:240)
=====

```

## Focusing on Preferences

Significant applications have *preferences*, which are configuration items. Examples include the location and size of the application's main window and the locations and names of files that the application most recently accessed. Preferences are persisted to a file, to a database, or to some other storage mechanism so that they will be available to the application the next time it runs.

The simplest approach to persisting preferences is to use the Properties API, which consists of the Properties class. This class persists preferences as a series of *key=value* entries to text-based properties files. Although properties files are ideal for simple applications with few preferences, they have proven to be problematic with larger applications:

- Properties files tend to grow in size, and the probability of name collisions among the various keys increases. This problem could be eliminated if properties files stored preferences in a hierarchy, but they're nonhierarchical.
- As an application grows in size and complexity, it tends to acquire numerous properties files with each part of the application associated with its own properties file. The names and locations of these properties files must be hard-coded in the application's source code.

Additionally, someone could directly modify these text-based properties files (perhaps inserting gibberish), causing the application that depends upon the modified properties file to crash unless it's properly coded to deal with this possibility. Also, properties files cannot be used on diskless computing platforms. Because of these problems, Java offers the Preferences API as a replacement for the Properties API.

**Note** Android provides its own preferences mechanism that you'll most likely use when creating Android apps. However, it's still good to know about Preferences. For example, suppose your company plans to develop an app that must communicate with a server-based application that you must develop. This application may need to use the Preferences API to persist its preferences.

## Exploring Preferences

The Preferences API lets you store preferences in a hierarchical manner so that you can avoid name collisions. Because this API is backend-neutral, it doesn't matter where the preferences are stored (a file, a database, or [on Windows platforms] the registry); you don't have to hardcode filenames and locations. Also, there are no text files that can be modified, and Preferences can be used on diskless platforms.

This API uses trees of nodes to manage preferences. These nodes are the analogue of a hierarchical filesystem's directories. Also, preference name/value pairs stored under these nodes are the analogues of a directory's files. You navigate these trees in a similar manner to navigating a filesystem: specify an absolute path starting from the root node (/) to the node of interest; for example, /window/location and /window/size.

There are two kinds of trees: system and user. All users share the *system preference tree*, whereas the *user preference tree* is specific to a single user, which is generally the person who logged into the underlying platform. (The precise description of "user" and "system" varies from implementation to implementation of the Preferences API.)

Although the Preferences API's `java.util.prefs` package contains three interfaces (`NodeChangeListener`, `PreferencesChangeListener`, and `PreferencesFactory`), four regular classes (`AbstractPreferences`, `NodeChangeEvent`, `PreferenceChangeEvent`, and `Preferences`), and two exception classes (`BackingStoreException` and `InvalidPreferencesFormatException`), you mostly work with the `Preferences` class.

The `Preferences` class describes a node in a tree of nodes. To obtain a `Preferences` node, you must call one of the following class methods:

- `Preferences` `systemNodeForPackage(Class<?> c)`: Returns the node whose path corresponds to the package containing the class represented by `c` from the system preference tree.
- `Preferences` `systemRoot()`: Returns the root preference node of the system preference tree.
- `Preferences` `userNodeForPackage(Class<?> c)`: Returns the node whose path corresponds to the package containing the class represented by `c` from the current user's preference tree.
- `Preferences` `userRoot()`: Returns the root preference node of the current user's preference tree.

Listing 16-51 demonstrates `systemNodeForPackage()` along with `Preferences`' `void put(String key, String value)` and `String get(String key, String def)` methods for storing `String`-based preferences to and retrieving `String`-based preferences from the system preference tree. A default value must be passed to `get()` in case no value is associated with the key (which shouldn't happen in this example).

*Listing 16-51. Storing a Single Preference to and Retrieving a Single Preference from the System Preference Tree*

```

package ca.tutortutor.examples;

import java.util.prefs.Preferences;

public class PrefsDemo
{
    public static void main(String[] args)
    {
        Preferences prefs = Preferences.systemNodeForPackage(PrefsDemo.class);
        prefs.put("version", "1.0");
        System.out.println(prefs.get("version", "unknown"));
    }
}

```

Create a `ca\tutortutor\examples` (or `ca/tutortutor/examples`) directory hierarchy under the current directory, and copy `PrefsDemo.java` into `examples`. Assuming that you haven't changed the current directory to another directory, execute either of the following commands to compile this source file:

```

javac ca\tutortutor\examples\PrefsDemo.java
javac ca/tutortutor/examples/PrefsDemo.java

```

Run this application as follows:

```

java ca.tutortutor.examples.PrefsDemo

```

You should observe the following output:

---

```

1.0

```

---

However, if you run this application on Windows 7, you might encounter the following warning messages followed by `unknown` instead:

```

Jan 08, 2014 12:23:22 PM java.util.prefs.WindowsPreferences <init>
WARNING: Could not create windows registry node Software\JavaSoft\Prefs\ca at root 0x80000002.
Windows RegCreateKeyEx(...) returned error code 5.
Jan 08, 2014 12:23:23 PM java.util.prefs.WindowsPreferences WindowsRegOpenKey1
WARNING: Trying to recreate Windows registry node Software\JavaSoft\Prefs\ca at root 0x80000002.
Jan 08, 2014 12:23:23 PM java.util.prefs.WindowsPreferences openKey
WARNING: Could not open windows registry node Software\JavaSoft\Prefs\ca at root 0x80000002.
Windows RegOpenKey(...) returned error code 2.
Jan 08, 2014 12:23:23 PM java.util.prefs.WindowsPreferences WindowsRegOpenKey1
WARNING: Trying to recreate Windows registry node Software\JavaSoft\Prefs\ca\tutortutor at root
0x80000002.
Jan 08, 2014 12:23:23 PM java.util.prefs.WindowsPreferences openKey
WARNING: Could not open windows registry node Software\JavaSoft\Prefs\ca\tutortutor at root
0x80000002. Windows RegOpenKey(...) returned error code 2.
Jan 08, 2014 12:23:23 PM java.util.prefs.WindowsPreferences WindowsRegOpenKey1

```

```

WARNING: Trying to recreate Windows registry node Software\JavaSoft\Prefs\ca\tutortutor\examples at
root 0x80000002.
Jan 08, 2014 12:23:23 PM java.util.prefs.WindowsPreferences openKey
WARNING: Could not open windows registry node Software\JavaSoft\Prefs\ca\tutortutor\examples at root
0x80000002. Windows RegOpenKey(...) returned error code 2.
Jan 08, 2014 12:23:23 PM java.util.prefs.WindowsPreferences WindowsRegOpenKey1
WARNING: Trying to recreate Windows registry node Software\JavaSoft\Prefs\ca\tutortutor\examples at
root 0x80000002.
Jan 08, 2014 12:23:23 PM java.util.prefs.WindowsPreferences openKey
WARNING: Could not open windows registry node Software\JavaSoft\Prefs\ca\tutortutor\examples at root
0x80000002. Windows RegOpenKey(...) returned error code 2.

```

These warning messages have to do with Windows security and its User Access Control (UAC) system. You need to disable UAC before you can run this program because it's making system-oriented changes. You can learn how to disable UAC by checking out Microsoft's instructions at <http://windows.microsoft.com/en-us/windows/turn-user-account-control-on-off#1TC=windows-7>.

Assuming that you can view the aforementioned 1.0, you should also be able to see some changes in the Windows 7 registry. Figure 16-10 reveals these changes.

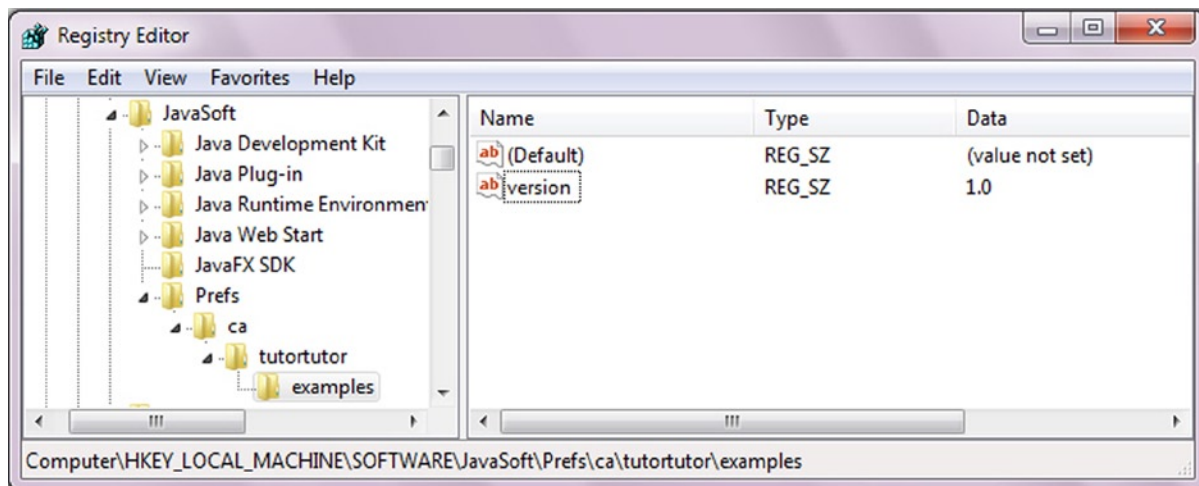

**Figure 16-10.** The Windows 7 registry reveals the hierarchy for accessing the version key

Computer\HKEY\_LOCAL\_MACHINE\SOFTWARE\JavaSoft\Prefs is the path to the Windows 7 registry area for storing system preferences. Under Prefs, you'll find a node for each package stored in this area. For example, ca identifies Listing 16-51's ca package. Continuing, a hierarchy of nodes is stored under ca. Within the bottommost node (examples), you find an entry consisting of version (the key) and 1.0 (the value).

Listing 16-52 provides a second example that works with the user preference tree and presents a more complex key.

*Listing 16-52. Storing a Single Preference to and Retrieving a Single Preference from the Current User's Preference Tree*

```

package ca.tutortutor.examples;

import java.util.prefs.Preferences;

public class PrefsDemo
{
    public static void main(String[] args)
    {
        Preferences prefs = Preferences.userNodeForPackage(PrefsDemo.class);
        prefs.put("SearchEngineURL", "http://www.google.com");
        System.out.println(prefs.get("SearchEngineURL", "http://www.bing.com"));
    }
}

```

Compile this listing and run the application as previously demonstrated. You shouldn't observe any security-oriented warning messages. Instead, you should observe the following output:

---

<http://www.google.com>

---

More interestingly, Figure 16-11 reveals how this preference is stored in the Windows 7 registry.

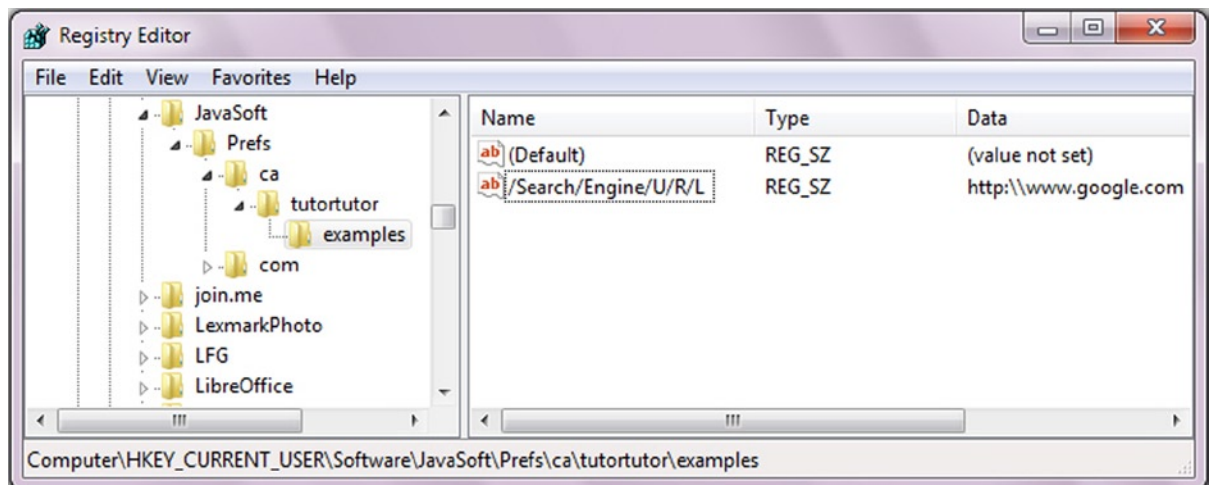

**Figure 16-11.** The Windows 7 registry reveals the hierarchy for accessing the SearchEngineURL key

Computer\HKEY\_CURRENT\_USER\Software\JavaSoft\Prefs is the path to the Windows 7 registry area for storing user preferences. The Windows 7 registry encodes the SearchEngineURL key into /Search/Engine/U/R/L, because Preferences regards keys and node names as case sensitive but the Windows 7 registry doesn't.

**Note** Learn more about the Preferences API from Ray Djajadinata's "Sir, what is your preference?" article ([www.javaworld.com/javaworld/jw-08-2001/jw-0831-preferences.html](http://www.javaworld.com/javaworld/jw-08-2001/jw-0831-preferences.html)). Also, because Android defines its own preferences mechanism, check out Ilias Tsagklis's "Android Quick Preferences Tutorial" ([www.javacodegeeks.com/2011/01/android-quick-preferences-tutorial.html](http://www.javacodegeeks.com/2011/01/android-quick-preferences-tutorial.html)).

## Focusing on Runtime and Process

The `java.lang.Runtime` class provides Java applications with access to their runtime environment. An instance of this class is obtained by invoking its `Runtime.getRuntime()` class method.

**Note** There is only one instance of the `Runtime` class.

`Runtime` declares several methods that are also declared in `System`. For example, `Runtime` declares a `void gc()` method. Behind the scenes, `System` defers to its `Runtime` counterpart by first obtaining the `Runtime` instance and then invoking this method via that instance. For example, `System`'s static `void gc()` method executes `Runtime.getRuntime().gc();`

`Runtime` also declares methods with no `System` counterparts. The following list describes a few of these methods:

- `int availableProcessors()` returns the number of processors that are available to the virtual machine. The minimum value returned by this method is 1.
- `long freeMemory()` returns the amount of free memory (measured in bytes) that the virtual machine makes available to the application.
- `long maxMemory()` returns the maximum amount of memory (measured in bytes) that the virtual machine may use (or `java.lang.Long.MAX_VALUE` when there is no limit).
- `long totalMemory()` returns the total amount of memory (measured in bytes) that is available to the virtual machine. This amount may vary over time depending on the environment that is hosting the virtual machine.

Listing 16-53 demonstrates these methods.

### *Listing 16-53. Experimenting with Runtime Methods*

```
public class RuntimeDemo
{
    public static void main(String[] args)
    {
        Runtime rt = Runtime.getRuntime();
        System.out.println("Available processors: " + rt.availableProcessors());
        System.out.println("Free memory: "+ rt.freeMemory());
    }
}
```

```

        System.out.println("Maximum memory: " + rt.maxMemory());
        System.out.println("Total memory: " + rt.totalMemory());
    }
}

```

Compile Listing 16-53 as follows:

```
javac RuntimeDemo.java
```

Run this application as follows:

```
java RuntimeDemo
```

When I run this application on my platform, I observe the following results:

---

```

Available processors: 2
Free memory: 123997936
Maximum memory: 1849229312
Total memory: 124649472

```

---

Some of Runtime's methods are dedicated to executing other applications. For example, `Process exec(String program)` executes the program named `program` in a separate native *process* (executing application). The new process inherits the environment of the method's caller, and a `java.lang.Process` object is returned to allow communication with the new process. `IOException` is thrown when an I/O error occurs.

**Tip** The `java.lang.ProcessBuilder` class is a convenient alternative for configuring process attributes and running a process. For example, `Process p = new ProcessBuilder("myCommand", "myArg").start();`

Table 16-3 describes Process methods.

**Table 16-3. Process Methods**

Method	Description
<code>void destroy()</code>	Terminates the calling process and closes any associated streams.
<code>int exitValue()</code>	Returns the exit value of the native process represented by this <code>Process</code> object (the new process). <code>java.lang.IllegalThreadStateException</code> is thrown when the native process has not yet terminated.

(continued)



**Table 16-3.** (continued)

Method	Description
<code>InputStream getErrorStream()</code>	Returns an input stream that's connected to the standard error stream of the native process represented by this <code>Process</code> object. The stream obtains data piped from the error output of the process represented by this <code>Process</code> object.
<code>InputStream getInputStream()</code>	Returns an input stream that's connected to the standard output stream of the native process represented by this <code>Process</code> object. The stream obtains data piped from the standard output of the process represented by this <code>Process</code> object.
<code>OutputStream getOutputStream()</code>	Returns an output stream that's connected to the standard input stream of the native process represented by this <code>Process</code> object. Output to the stream is piped into the standard input of the process represented by this <code>Process</code> object.
<code>int waitFor()</code>	Causes the calling thread to wait for the native process associated with this <code>Process</code> object to terminate. The process's exit value is returned. By convention, 0 indicates normal termination. This method throws <code>java.lang.InterruptedException</code> when the current thread is interrupted by another thread while waiting.

Listing 16-54 demonstrates `exec(String program)` and three of `Process`'s methods.

**Listing 16-54.** Executing Another Application and Displaying Its Standard Output/Error Content

```
import java.io.InputStream;
import java.io.IOException;

public class Exec
{
    public static void main(String[] args)
    {
        if (args.length != 1)
        {
            System.err.println("usage: java Exec program");
            return;
        }
        try
        {
            Process p = Runtime.getRuntime().exec(args[0]);
            // Obtaining process standard output.
            InputStream is = p.getInputStream();
            int _byte;
            while ((_byte = is.read()) != -1)
                System.out.print((char) _byte);
        }
    }
}
```

```

        // Obtaining process standard error.
        is = p.getErrorStream();
        while ((_byte = is.read()) != -1)
            System.out.print((char) _byte);
        System.out.println("Exit status: " + p.waitFor());
    }
    catch (InterruptedException ie)
    {
        assert false; // should never happen
    }
    catch (IOException ioe)
    {
        System.err.println("I/O error: " + ioe.getMessage());
    }
}
}
}

```

After verifying that exactly one command-line argument has been specified, Listing 16-54's `main()` method attempts to run the application identified by this argument. `IOException` is thrown when the application cannot be located or when some other I/O error occurs.

Assuming that everything is fine, `getInputStream()` is called to obtain a reference to an input stream that's used to input the bytes that the newly invoked application writes to its standard output stream, if any. These bytes are subsequently output.

Next, `main()` calls `getErrorStream()` to obtain a reference to an input stream that's used to input the bytes that the newly invoked application writes to its standard error stream, if any. These bytes are subsequently output.

**Note** To guard against confusion, remember that `Process`'s `getInputStream()` method is used to read bytes that the new process writes to its output stream, whereas `Process`'s `getErrorStream()` method is used to read bytes that the new process writes to its error stream.

Finally, `main()` calls `waitFor()` to block until the new process exits. If the new process is a GUI-based application, this method won't return until you explicitly terminate the new process. For simple command-line-based applications, `Exec` should terminate immediately.

Compile Listing 16-54 as follows:

```
javac Exec.java
```

Then execute a command line that identifies an application, such as the `java` application launcher:

```
java Exec java
```

You should observe `java`'s usage information followed by the following line:

---

```
Exit status: 1
```

---

**Caution** Because some native platforms provide limited buffer size for standard input and output streams, failure to promptly write the new process's input stream or read its output stream may cause the new process to block, or even deadlock.

## Focusing on the Java Native Interface

The *Java Native Interface (JNI)* is a native programming interface that lets Java code running in a virtual machine interoperate with *native libraries* (platform-specific libraries) written in other languages (such as C, C++, or even assembly language). The JNI is a bridge between the virtual machine and the underlying platform to which the native libraries target.

**Note** The standard class library uses the JNI to read/write files, output graphics to the screen, send data to a network socket, and so on. These tasks are platform-specific and are performed by the underlying platform.

Your applications can leverage the JNI when necessary. There are three common scenarios where you would leverage the JNI to bypass the virtual machine:

- The application must access an unsupported platform-specific API (such as the Win32/Win64 Joystick [<http://en.wikipedia.org/wiki/Joystick>] API).
- The application must interact with a native library of legacy code (such as a library of statistics routines that predates Java).
- The application must perform complex calculations that exhibit better performance in native code (platform-specific instructions) than in Java code.

You would also use the JNI in an Android context when working with Android's Native Development Kit (NDK).

**Note** The decision to use the JNI shouldn't be made lightly. This technology restricts application execution to specific platforms (such as Windows only), is complex (subtle errors can crash the virtual machine), requires you to learn how to use the C language (or its C++ offspring), and causes application performance to suffer when native code is called frequently (native calls are often 2-3 times slower than Java calls).

## Creating a Hybrid Library

When working with the JNI, you're essentially creating a hybrid library consisting of a Java class and a native interface library. This is explained in the following sections.

## Java Class

The Java class uses the native reserved word to declare one or more *native methods* (methods whose bodies consist of native code stored in a native interface library). Consider the following example:

```
static native int joyGetNumDevs();
```

This example declares a native `joyGetNumDevs()` class method for returning the number of joystick devices (as a 32-bit integer) that are supported by the underlying Windows platform's joystick driver. When the Java compiler encounters `native`, it marks this method as a native method in the classfile. At runtime, the virtual machine knows that it must transfer execution to the equivalent native code when it encounters a call to `joyGetNumDevs()`.

The Java class also provides code to load the native interface library that provides a *native function* (a C-based function) counterpart for each declared native method. This code is often specified via a class initializer, as follows:

```
static
{
    System.loadLibrary("joystick");
}
```

This example's class initializer invokes `System`'s void `loadLibrary(String libname)` class method, where `libname` is the name of the native library without a platform-specific prefix (such as `lib`) or extension (such as `.so` or `.dll`). This method either loads the native library or throws an exception: `NullPointerException` is thrown when you pass `null` to `libname` and `java.lang.UnsatisfiedLinkError` is thrown when the library doesn't exist (or doesn't contain the equivalent native function).

Because of the possibility for `UnsatisfiedLinkError`, which causes the application to terminate when thrown from a class initializer, I've often found it convenient to express the aforementioned code via an `init()` class method that returns a `Boolean true/false` value.

Listing 16-55 presents a `Joystick` class that declares the `joyGetNumDevs()` native method and the `init()` class method.

### Listing 16-55. The Java Side of the Joystick Hybrid Library

```
class Joystick
{
    static boolean init()
    {
        try
        {
            System.loadLibrary("joystick");
            return true;
        }
    }
}
```

```

        catch (UnsatisfiedLinkError ule)
        {
            return false;
        }
    }
    static native int joyGetNumDevs();
}

```

Listing 16-55's `init()` method returns true when the native interface library is successfully loaded; otherwise, it returns false. You can call this method at application startup and gracefully degrade the application (or at least present a termination message to the user) when this method returns false.

## Building the Java Class

Compile Listing 16-55 as follows:

```
javac Joystick.java
```

## Native Interface Library

The *native interface library* is a native library that contains JNI function calls and the native code that you want to execute (such as a Win32/Win64 function call that returns the number of supported joystick devices). This native code might serve as an interface between the native interface library and a legacy library.

Before you can code the native interface library, you need to generate a C-based include file that contains C function prototypes corresponding to the native methods. Accomplish this task with the help of the `javah` (Java header) tool. For example, the following command generates an include file for Listing 16-55; you don't have to compile the source file before using `javah`:

```
javah Joystick
```

`javah` analyzes `Joystick.java` (you cannot specify the `.java` extension) and generates a file named `Joystick.h`. This include file is presented in Listing 16-56.

### Listing 16-56. Discovering the C Language Native Function Declaration

```

/* DO NOT EDIT THIS FILE - it is machine generated */
#include <jni.h>
/* Header for class Joystick */

#ifdef _Included_Joystick
#define _Included_Joystick
#ifdef __cplusplus
extern "C" {
#endif
/*
 * Class:    Joystick
 * Method:   joyGetNumDevs
 * Signature: ()I
 */

```

```
JNIEXPORT jint JNICALL Java_Joystick_joyGetNumDevs
    (JNIEnv *, jclass);

#ifdef __cplusplus
}
#endif
#endif
```

Listing 16-56 begins with an `#include` C language preprocessor directive that includes the contents of a JDK file named `jni.h` in the source code. This header file declares various structures and JNI functions that a native function uses to cooperate with the Java platform, and it is located in the `%JAVA_HOME%\include` directory.

The other significant item is `JNIEXPORT jint JNICALL Java_Joystick_joyGetNumDevs(JNIEnv *, jclass);`. This C function prototype names the native function where the Joystick portion of the name identifies the class in which the corresponding native method is declared. It also describes the parameter list in terms of types only; C doesn't require names to be specified when declaring a function prototype.

The parameter of `JNIEnv *` type is a pointer to a C structure that makes it possible to call various JNI functions to perform useful work. No JNI functions are required in this example.

The parameter of `jclass` type identifies the class of which `joyGetNumDevs()` is a member. If `joyGetNumDevs()` was an instance method, this parameter would be of `jobject` type, which holds a reference to the current object on which the `joyGetNumDevs()` native method was invoked; think of the `jobject` parameter as containing `this`'s value.

**Note** Much of Listing 16-56 makes sure that the `Java_Joystick_joyGetNumDevs(JNIEnv *, jclass)` function can be invoked in the context of C++ without C++ name mangling ([http://en.wikipedia.org/wiki/Name\\_mangling](http://en.wikipedia.org/wiki/Name_mangling)) getting in the way.

Listing 16-57 presents the C code that implements `Java_Joystick_joyGetNumDevs(JNIEnv *, jclass)`.

*Listing 16-57. The C Side of the Joystick Hybrid Library*

```
#include <windows.h>
#include "Joystick.h"

JNIEXPORT jint JNICALL Java_Joystick_joyGetNumDevs(JNIEnv *pEnv, jclass clazz)
{
    return joyGetNumDevs();
}
```

Listing 16-57 first specifies an `#include <windows.h>` directive, which provides access to Win32's `joyGetNumDevs()` multimedia function prototype, and an `#include "Joystick.h"` directive, which includes `jni.h` and the `Java_Joystick_joyGetNumDevs(JNIEnv *, jclass)` function prototype. The native function simply invokes `joyGetNumDevs()` and returns its value.

## Building the Native Interface Library

Various C/C++ compilers can be used to create the native interface library. I'm partial to the GNU Compiler Collection (see [http://en.wikipedia.org/wiki/GNU\\_Compiler\\_Collection](http://en.wikipedia.org/wiki/GNU_Compiler_Collection)), which includes a C compiler.

You can obtain a version of this software for your Unix-oriented platform by pointing your browser to <http://gcc.gnu.org/> and following instructions. If your platform is Windows, you will need an environment such as MinGW (<http://en.wikipedia.org/wiki/Mingw>) to run this compiler. You can obtain a copy of MinGW by pointing your browser to [www.mingw.org](http://www.mingw.org) and following instructions.

Assuming a Windows platform; that Java 7 Update 6 is installed into the `c:\progra~1\java\jdk1.7.0_06` home directory (`progra~1` is shorthand for Program Files); and that the current directory contains `Joystick.java`, `Joystick.h`, and `joystick.c` (with Listing 16-57's contents); and that you're using MinGW; execute the following command (spread across two lines here for readability) to compile `joystick.c` into `joystick.o`:

```
gcc -c -Ic:\progra~1\java\jdk1.7.0_06\include\ -Ic:\progra~1\java\jdk1.7.0_06\include\win32\
joystick.c
```

The `-c` option specifies that an object file is to be created and the `-I` option specifies the include paths for `jni.h` and `jni_md.h`—`jni_md.h` is a machine-dependent file located in the `%JAVA_HOME%\include\win32` directory. The end result is an object file named `joystick.o`.

Execute the following command line to turn this object file into a `joystick.dll` library:

```
gcc -Wl,--kill-at -shared -o joystick.dll joystick.o -lwinmm
```

The `-Wl,--kill-at` option specifies no name mangling (which leads to unsatisfied link errors), the `-shared` option specifies a Windows DLL target, the `-o` option specifies the output library name, and the `-l` option specifies a library to be included in the link step. The specified library is `winmm`, which is an import library needed by Windows to ensure that it can locate the proper DLL containing `joyGetNumDevs()`.

## Testing the Hybrid Library

Assuming that you've successfully created `Joystick.class` and the `joystick.dll` native interface library, you'll want to test this library's solitary native function. Listing 16-58 presents the source code to a small application that accomplishes this task.

### *Listing 16-58. Testing the Joystick Hybrid Library*

```
class JoystickDemo
{
    public static void main(String[] args)
    {
        if (!Joystick.init())
        {
            System.err.println("unable to load joystick library");
            return;
        }
    }
}
```

```

        System.out.printf("Number of joysticks = %d\n", Joystick.joyGetNumDevs());
    }
}

```

Compile Listing 16-58 as follows:

```
javac JoystickDemo.java
```

Run this application as follows:

```
java JoystickDemo
```

On my Windows 7 platform, I observed the following output:

---

```
Number of joysticks = 16
```

---

The Windows 7 joystick driver supports a maximum of 16 joystick devices.

**Note** You might run into an unsatisfied link error stating that a 32-bit DLL cannot be loaded onto a 64-bit platform. This error most likely occurs because you're running a 64-bit version of the virtual machine and attempting to load a 32-bit DLL into this machine. You'll need to install and run a 32-bit version of the virtual machine to make the example work.

To learn more about the JNI, I recommend that you check out the somewhat dated *The Java Native Interface Programmer's Guide and Specification* ([www.amazon.com/Java-Native-Interface-Programmers-Specification/dp/0201325772](http://www.amazon.com/Java-Native-Interface-Programmers-Specification/dp/0201325772)) and *Essential JNI: Java Native Interface* ([www.amazon.com/Essential-Jni-Java-Native-Interface/dp/0136798950](http://www.amazon.com/Essential-Jni-Java-Native-Interface/dp/0136798950)) books.

## Focusing on ZIP and JAR

You might need to develop an application that must create a new ZIP file and store files in that file or extract content from an existing ZIP file. Perhaps you might need to perform either task in the context of a JAR file, which you might think of as a ZIP file with a `.jar` file extension. This section introduces you to the APIs for working with ZIP and JAR files.

### Focusing on the ZIP API

The `java.util.zip` package provides classes for working with ZIP files, which are also known as *ZIP archives*. Each ZIP archive stores files that are typically compressed, and each stored file is known as a *ZIP entry*. You can use these classes to write ZIP entries to or read ZIP entries from a ZIP archive in the standard ZIP and GZIP (GNU ZIP) file formats; compress and decompress data via the DEFLATE compression algorithm that these formats use; and compute the CRC-32 and Adler-32 checksums of arbitrary input streams.



**Note** See Wikipedia's "Cyclic redundancy check" (<http://en.wikipedia.org/wiki/CRC-32>) and "Adler-32" (<http://en.wikipedia.org/wiki/Adler-32>) entries to learn about CRC-32 and Adler-32.

The `ZipEntry` class represents a ZIP entry. You must instantiate this class to write new entries to a ZIP archive or read entries from an existing ZIP archive. `ZipEntry` offers two constructors:

- `ZipEntry(String name)` creates a new ZIP entry with the specified name. This constructor throws `NullPointerException` when `name` is null and `IllegalArgumentException` when the length of the string assigned to `name` exceeds 65,535 bytes.
- `ZipEntry(ZipEntry ze)` creates a new ZIP entry with values taken from existing ZIP entry `ze`.

Additionally, `ZipEntry` declares several methods including those presented in the following list:

- `String getComment()` returns the entry's comment string or null when there is no comment string. A *comment* provides user-specific information associated with an entry.
- `long getCompressedSize()` returns the size of the entry's compressed data, or -1 when not specified. The compressed size is the same as the uncompressed size when the entry data is stored without compression.
- `long getCrc()` returns the CRC-32 checksum of the entry's uncompressed data or -1 when the checksum hasn't been specified.
- `int getMethod()` returns the compression method used to compress the entry's data. This value is one of `ZipEntry`'s `DEFLATED` or `STORED` (not compressed) constants or is -1 when the compression method hasn't been specified.
- `String getName()` returns the entry's name.
- `long getSize()` returns the uncompressed size of the entry's data or -1 when the size hasn't been specified.
- `boolean isDirectory()` returns true when the entry describes a directory; otherwise, this method returns false.
- `void setComment(String comment)` sets the entry's comment string to `comment`. A comment string is optional. When specified, the maximum length should be 65,535 bytes; remaining bytes are truncated.
- `void setCompressedSize(long csize)` sets the size (in bytes) of the entry's compressed data to `csize`.
- `void setCrc(long crc)` sets the CRC-32 checksum of the entry's uncompressed data to `crc`. This method throws `IllegalArgumentException` when `crc`'s value is less than 0 or greater than `0xFFFFFFFF`.

- `void setMethod(int method)` sets the compression method to `method`. This method throws `IllegalArgumentException` when any value other than `ZipEntry.DEFLATED` (compress data file at a specific level) or `ZipEntry.STORED` (don't compress) is passed to `method`.
- `void setSize(long size)` sets the uncompressed size of the entry's data to `size`. This method throws `IllegalArgumentException` when `size`'s value is less than 0 or the value is greater than `0xFFFFFFFF` when "ZIP64" ([http://en.wikipedia.org/wiki/Zip\\_\(file\\_format\)#ZIP64](http://en.wikipedia.org/wiki/Zip_(file_format)#ZIP64)) isn't supported.

You will soon learn how to work with this class.

## Writing Files to a ZIP Archive

Use the `ZipOutputStream` class to write ZIP entries (compressed as well as uncompressed) to a ZIP archive. `ZipOutputStream` declares the `ZipOutputStream(OutputStream out)` constructor for creating a ZIP output stream. Although `ZipEntry` instances are conceptually written to this stream, it's really the data described by these instances that's written.

**Note** Use the `GZIPOutputStream` class to create a GZIP archive and write files to this archive in the GZIP format. For brevity, I don't discuss this class.

The following example instantiates `ZipOutputStream` with an underlying file output stream:

```
ZipOutputStream zos = new ZipOutputStream(new FileOutputStream("archive.zip"));
```

`ZipOutputStream` also declares several methods and inherits additional methods from its `DeflaterOutputStream` superclass. You minimally work with the following methods:

- `void close()` closes the ZIP output stream along with the underlying output stream.
- `void closeEntry()` closes the current ZIP entry and positions the stream for writing the next entry.
- `void putNextEntry(ZipEntry e)` begins writing a new ZIP entry and positions the stream to the start of the entry data. The current entry is closed when still active (that is, when `closeEntry()` wasn't invoked on the previous entry).
- `void write(byte[] b, int off, int len)` writes `len` bytes starting at offset `off` from buffer `b` to the current ZIP entry. This method will block until all the bytes are written.

Each method throws `IOException` when a generic I/O error has occurred and `ZipException` (which subclasses `IOException`) when a ZIP-specific I/O error has occurred.

Listing 16-59 presents a `ZipCreate` application that shows you how to minimally use `ZipOutputStream` and `ZipEntry` to store assorted files in a new ZIP archive.

*Listing 16-59. Creating a ZIP Archive and Storing Specified Files in That Archive*

```

import java.io.FileInputStream;
import java.io.FileOutputStream;
import java.io.IOException;

import java.util.zip.ZipEntry;
import java.util.zip.ZipOutputStream;

public class ZipCreate
{
    public static void main(String[] args) throws IOException
    {
        if (args.length < 2)
        {
            System.err.println("usage: java ZipCreate ZIPfile infile1 "+
                               "infile2 ...");
            return;
        }
        ZipOutputStream zos = null;
        try
        {
            zos = new ZipOutputStream(new FileOutputStream(args[0]));
            byte[] buf = new byte[1024];
            for (String filename: args)
            {
                if (filename.equals(args[0]))
                    continue;
                FileInputStream fis = null;
                try
                {
                    fis = new FileInputStream(filename);
                    zos.putNextEntry(new ZipEntry(filename));
                    int len;
                    while ((len = fis.read(buf)) > 0)
                        zos.write(buf, 0, len);
                }
                catch (IOException ioe)
                {
                    System.err.println("I/O error: " + ioe.getMessage());
                }
            }
            finally
            {
                if (fis != null)
                {
                    try
                    {
                        fis.close();
                    }
                    catch (IOException ioe)
                    {
                        assert false; // shouldn't happen in this context
                    }
                }
            }
        }
    }
}

```

```

        zos.closeEntry();
    }
}
catch (IOException ioe)
{
    System.err.println("I/O error: " + ioe.getMessage());
}
finally
{
    if (zos != null)
        try
        {
            zos.close();
        }
        catch (IOException ioe)
        {
            assert false; // shouldn't happen in this context
        }
}
}
}
}

```

Listing 16-59 is fairly straightforward. It first validates the number of command-line arguments, which must be at least two: the first argument is always the name of the ZIP file to be created. If successful, this application creates a ZIP output stream with an underlying file output stream to this file and then writes the contents of those files identified by successive command-line arguments to the ZIP output stream.

The only part of this source code that might seem confusing is `if (filename.equals(args[0])) continue;`. This statement prevents the first command-line argument, which happens to be the name of the ZIP archive, from being added to the archive, which doesn't make sense because of its recursive nature. If this possibility was permitted, a `ZipException` instance containing a "duplicate entry" message would be thrown.

Compile Listing 16-59 as follows:

```
javac ZipCreate.java
```

Run this application via the following command line, which creates a ZIP archive named `a.zip` and stores file `ZipCreate.java` in this archive; the application isn't recursive (it won't recurse into directories):

```
java ZipCreate a.zip ZipCreate.java
```

You shouldn't observe any output. Instead, you should observe a file named `a.zip` in the current directory. Furthermore, when you `unzip a.zip`, you should detect an unarchived `ZipCreate.java` file.

You cannot store duplicate files in an archive because that makes no sense. For example, you'll observe an exception message about a duplicate entry when you execute the following command line:

```
java ZipCreate a.zip ZipCreate.java ZipCreate.java
```

`ZipOutputStream` offers more capabilities. For example, you can use its `void setLevel(int level)` method to set the compression level for successive entries. Specify an integer argument from 0 through 9, where 0 indicates no compression and 9 indicates best compression; better compression slows down performance. (Google reports these limits as -1 and 8.) Alternatively, specify one of the `Deflater` class's `BEST_COMPRESSION`, `BEST_SPEED`, `DEFAULT_COMPRESSION` (to which `setLevel()` defaults), and other constants as an argument.

## Reading Files from a ZIP Archive

Use the `ZipInputStream` class to read ZIP entries (compressed as well as uncompressed) from a ZIP archive. `ZipInputStream` declares the `ZipInputStream(InputStream in)` constructor for creating a ZIP input stream. Although `ZipEntry` instances are conceptually read from this stream, it's really the data described by these instances that's read.

**Note** Use the `GZIPInputStream` class to open a GZIP archive and read files from this archive in the GZIP format. For brevity, I don't discuss this class.

The following example instantiates `ZipInputStream` with an underlying file input stream:

```
ZipInputStream zis = new ZipInputStream(new FileInputStream("archive.zip"));
```

`ZipInputStream` also declares several methods and inherits additional methods from its `InflaterInputStream` superclass. You minimally work with the following methods:

- `void close()` closes the ZIP input stream along with the underlying input stream.
- `void closeEntry()` closes the current ZIP entry and positions the stream for reading the next entry.
- `ZipEntry getNextEntry()` reads the next ZIP entry and positions the stream to the start of the entry data. This method returns null when there are no more entries.
- `int read(byte[] b, int off, int len)` reads a maximum of `len` bytes from the current ZIP entry into buffer `b` starting at offset `off`. This method will block until all of the bytes are read.

Each method throws `IOException` when a generic I/O error has occurred and (except for `close()`) `ZipException` when a ZIP-specific I/O error has occurred. Also, `read()` throws `NullPointerException` when `b` is null and `java.lang.IndexOutOfBoundsException` when `off` is negative, `len` is negative, or `len` is greater than `b.length - off`.

Listing 16-60 presents a `ZipAccess` application that shows you how to minimally use `ZipInputStream` and `ZipEntry` to extract assorted files from an existing ZIP archive.

*Listing 16-60. Accessing a ZIP Archive and Extracting Specified Files from That Archive*

```
import java.io.FileInputStream;
import java.io.FileOutputStream;
import java.io.IOException;

import java.util.zip.ZipEntry;
import java.util.zip.ZipInputStream;

public class ZipAccess
{
    public static void main(String[] args) throws IOException
    {
        if (args.length != 1)
        {
            System.err.println("usage: java ZipAccess zipfile");
            return;
        }
        ZipInputStream zis = null;
        try
        {
            zis = new ZipInputStream(new FileInputStream(args[0]));
            byte[] buffer = new byte[4096];
            ZipEntry ze;
            while ((ze = zis.getNextEntry()) != null)
            {
                System.out.println("Extracting: " + ze);
                FileOutputStream fos = null;
                try
                {
                    fos = new FileOutputStream(ze.getName());
                    int numBytes;
                    while ((numBytes = zis.read(buffer, 0, buffer.length)) != -1)
                        fos.write(buffer, 0, numBytes);
                }
                catch (IOException ioe)
                {
                    System.err.println("I/O error: " + ioe.getMessage());
                }
                finally
                {
                    if (fos != null)
                    {
                        try
                        {
                            fos.close();
                        }
                        catch (IOException ioe)
                        {
                            assert false; // shouldn't happen in this context
                        }
                    }
                }
            }
        }
    }
}
```

```

        zis.closeEntry();
    }
}
catch (IOException ioe)
{
    System.err.println("I/O error: " + ioe.getMessage());
}
finally
{
    if (zis != null)
        try
        {
            zis.close();
        }
        catch (IOException ioe)
        {
            assert false; // shouldn't happen in this context
        }
}
}
}
}

```

Listing 16-60 is fairly straightforward. It first validates the number of command-line arguments, which must be exactly one: the name of the ZIP file to be accessed. Assuming success, it creates a ZIP input stream with an underlying file input stream to this file and then reads the contents of the various files that are stored in this archive, creating these files in the current directory.

Compile Listing 16-60 as follows:

```
javac ZipAccess.java
```

Run this application via the following command line, which accesses the previous a.zip archive and extracts file ZipCreate.java from this archive:

```
java ZipAccess a.zip
```

You should observe “Extracting: ZipCreate.java” as the single line of output, and you should also note the appearance of a ZipCreate.java file in the current directory.

## ZIPFILE VERSUS ZIPINPUTSTREAM

The `java.util.zip` package contains a `ZipFile` class that seems to be an alias for `ZipInputStream`. As with `ZipInputStream`, you can use `ZipFile` to read a ZIP file's entries. However, `ZipFile` has a couple of differences that make it worth considering as an alternative:

- `ZipFile` allows random access to ZIP entries via its `ZipEntry` `getEntry(String name)` method. Given a `ZipEntry` instance, you can call `ZipEntry`'s `InputStream` `getInputStream(ZipEntry entry)` method to obtain an input stream for reading the entry's content. `ZipInputStream` supports sequential access to ZIP entries.

- According to the “Compressing and Decompressing Data Using Java APIs” article ([www.oracle.com/technetwork/articles/java/compress-1565076.html](http://www.oracle.com/technetwork/articles/java/compress-1565076.html)), `ZipFile` internally caches ZIP entries for improved performance. `ZipInputStream` doesn’t cache entries.

You might be curious about a `ZipFile` constructor that declares a mode parameter of type `int`. The argument passed to mode is `ZipFile.OPEN_READ` or `ZipFile.OPEN_READ | ZipFile.OPEN_DELETE`. The latter argument causes the underlying file to be deleted sometime between when it’s opened and when it’s closed.

This capability was introduced by Java 1.3 to solve a problem related to caching downloaded JAR files in the context of long-running server applications or Remote Method Invocation. The problem is discussed at <http://docs.oracle.com/javase/7/docs/technotes/guides/lang/enhancements.html>.

## Focusing on the JAR API

The `java.util.jar` package provides classes for working with JAR files. Because a JAR file is a kind of ZIP file, it isn’t surprising that this package provides classes that extend their `java.util.zip` counterparts. For example, `java.util.jar.JarEntry` extends `java.util.zip.ZipEntry`.

The `java.util.jar` package also provides classes that have no `java.util.zip` counterparts, for example, `Manifest`. These classes provide access to JAR-specific capabilities. For example, `Manifest` lets you work with a JAR file’s manifest (explained shortly).

Listing 16-61 presents a `MakeRunnableJAR` application that shows you how to work with some of the types in the `java.util.jar` package to create a runnable JAR file.

*Listing 16-61. Creating a Runnable JAR File*

```
import java.io.FileInputStream;
import java.io.FileOutputStream;
import java.io.IOException;

import java.util.jar.Attributes;
import java.util.jar.JarEntry;
import java.util.jar.JarOutputStream;
import java.util.jar.Manifest;

public class MakeRunnableJAR
{
    public static void main(String[] args) throws IOException
    {
        if (args.length < 2)
        {
            System.err.println("usage: java MakeRunnableJAR JARfile " +
                "classfile1 classfile2 ...");
            return;
        }
        JarOutputStream jos = null;
        try
```



```
{
    Manifest mf = new Manifest();
    Attributes attr = mf.getMainAttributes();
    attr.put(Attributes.Name.MANIFEST_VERSION, "1.0");
    attr.put(Attributes.Name.MAIN_CLASS,
        args[1].substring(0, args[1].indexOf('.')));
    jos = new JarOutputStream(new FileOutputStream(args[0]), mf);
    byte[] buf = new byte[1024];
    for (String filename: args)
    {
        if (filename.equals(args[0]))
            continue;
        FileInputStream fis = null;
        try
        {
            fis = new FileInputStream(filename);
            jos.putNextEntry(new JarEntry(filename));
            int len;
            while ((len = fis.read(buf)) > 0)
                jos.write(buf, 0, len);
        }
        catch (IOException ioe)
        {
            System.err.println("I/O error: " + ioe.getMessage());
        }
        finally
        {
            if (fis != null)
                try
                {
                    fis.close();
                }
                catch (IOException ioe)
                {
                    assert false; // shouldn't happen in this context
                }
        }
        jos.closeEntry();
    }
}
catch (IOException ioe)
{
    System.err.println("I/O error: " + ioe.getMessage());
}
finally
{
    if (jos != null)
        try
        {
            jos.close();
        }
    }
}
```

```

        catch (IOException ioe)
        {
            assert false; // shouldn't happen in this context
        }
    }
}

```

Because Listing 16-61 is very similar to Listing 16-59, albeit with `java.util.jar` classes replacing their `java.util.zip` counterparts, I'll focus on only that part of this application that creates the manifest. However, you first need to understand the concept of a JAR file manifest.

A *manifest* is a special file named `MANIFEST.MF` that stores information about the contents of the JAR file. This file is located in the JAR file's `META-INF` directory. For example, the manifest would look as follows for an executable `hello.jar` JAR file containing a `Hello` application class:

```

Manifest-Version: 1.0
Main-Class: Hello

```

The first line signifies the version of the manifest and must be present. The second line identifies the application class that is to run when the JAR file is executed. A `.class` file extension must not be specified. Doing so would suggest that you want to run class `class` in the `Hello` package.

**Caution** You must insert an empty line after `Main-Class: Hello`. Otherwise, you'll receive a “no main manifest attribute, in `hello.jar`” error message when trying to run the application.

The key part of Listing 16-61 that sets it apart from Listing 16-59 is the following code fragment:

```

Manifest mf = new Manifest();
Attributes attr = mf.getMainAttributes();
attr.put(Attributes.Name.MANIFEST_VERSION, "1.0");
attr.put(Attributes.Name.MAIN_CLASS,
        args[1].substring(0, args[1].indexOf('.')));
jos = new JarOutputStream(new FileOutputStream(args[0]), mf);

```

The `Manifest` class is first instantiated (via its noargument constructor) to describe the soon-to-be-created manifest. Its `getMainAttributes()` method is then called to return an `Attributes` instance for accessing existing manifest attributes or creating new manifest attributes (such as `Main-Class`).

`Attributes` is essentially a map and provides `Object put(Object key, Object value)` for storing an attribute name/value pair. The value passed to key must be an `Attributes.Name` constant such as `Attributes.Name.MANIFEST_VERSION` or `Attributes.Name.MAIN_CLASS`.

**Caution** You must store `MANIFEST_VERSION`; otherwise, you'll observe a thrown exception at runtime.

Because the `.class` file extension must be specified when specifying the name of a classfile as a command-line argument, expression `args[1].substring(0, args[1].indexOf('.'))` is used to remove this extension. You can specify multiple classfile names as command-line arguments; the first name is stored (without its `.class` extension) in the manifest.

Finally, `JarOutputStream` is instantiated in a similar manner to `ZipOutputStream`. However, the initialized Manifest instance is also passed to the constructor as the second argument.

To play with this application, you minimally need a class with a public static void `main(String[] args)` method. For simplicity, consider Listing 16-62.

*Listing 16-62. Saying Hello*

```
public class Hello
{
    public static void main(String[] args)
    {
        System.out.println("Hello");
    }
}
```

Listing 16-62 isn't much of an application, but it is sufficient for our purpose. Compile Listings 16-61 and 16-62 as follows:

```
javac MakeRunnableJAR.java
javac Hello.java
```

Now execute the following command line:

```
java MakeRunnableJAR hello.jar Hello.class
```

If all goes well, you should observe a `hello.jar` file in the current directory. Execute the following command to run this file:

```
java -jar hello.jar
```

Assuming success, you should observe a single line of output consisting of `Hello`.

## EXERCISES

The following exercises are designed to test your understanding of Chapter 16's content.

1. Identify the two enhancements to numeric literals introduced by Java 7.
2. What does the diamond operator accomplish?
3. True or false: When multiple exception types are listed in a catch block's header, the parameter is implicitly regarded as `final`.
4. Identify the statement that Java 7 uses to implement automatic resource management.
5. Define classloader.

6. What is a classloader's purpose?
7. What classloaders are available when the virtual machine starts running?
8. True or false: The concrete `ClassLoader` class is the ultimate root class for all classloaders (including extension and system) except for bootstrap.
9. Which classloader is the root classloader?
10. Define current classloader.
11. Define context classloader.
12. Which methods are central to `ClassLoader`?
13. True or false: Context classloaders can be a source of difficulty.
14. Can you use a classloader to load arbitrary resources (such as images)?
15. What does the `Console` class provide?
16. How do you obtain the console?
17. True or false: `Console`'s `String readLine()` method reads a single line of text (including line-termination characters) from the console's input stream.
18. Define design pattern.
19. What does the Strategy pattern let you accomplish?
20. What is double brace initialization?
21. Identify the two drawbacks of double brace initialization.
22. Define fluent interface.
23. List five advantages that immutable classes have over mutable classes.
24. List four guidelines for making a class immutable.
25. Define internationalization.
26. Define localization.
27. Define locale.
28. How does Java represent a locale?
29. Specify an expression for obtaining the Canadian locale.
30. How do you change the default locale that's made available to the virtual machine?
31. Define resource bundle.
32. True or false: Each resource bundle family shares a common base name.
33. How does an application load its resource bundles?
34. What happens when a resource bundle cannot be found after an exhaustive search?
35. Define property resource bundle.
36. Define list resource bundle.

37. True or false: When a property resource bundle and a list resource bundle have the same complete resource bundle name, the property resource bundle takes precedence over the list resource bundle.
38. What methods does `ResourceBundle` provide that make it possible to design a server application that clears out all cached resource bundles upon command?
39. Why did Java 6 rework `ResourceBundle` to depend on a nested `Control` class?
40. What does the `BreakIterator` class let you accomplish?
41. What does the `Collator` class let you accomplish?
42. Define date, time zone, and calendar.
43. How does the `Date` class represent a date?
44. How do you obtain a calendar for the default locale that uses a specific time zone?
45. True or false: `Calendar` declares a `Date getDate()` method that returns a calendar's time representation as a `Date` instance.
46. Which `Format` subclass lets you obtain formatters that format numbers as currencies, integers, numbers with decimal points, and percentages (and also to parse such values)?
47. How would you obtain a date formatter to format the time portion of a date in a particular style for the default locale?
48. What is the difference between a simple message and a compound message?
49. How do you format a simple message and a compound message?
50. Which class does Java provide to format simple and compound messages?
51. What class should you use to format a compound message that contains singular and plural words?
52. True or false: The `Format` class declares `parseObject()` methods for parsing strings into objects.
53. Identify the package associated with Java's Logging API.
54. Which class is the entry-point into the Logging API?
55. Identify the standard set of log level constants provided by the `Level` class?
56. True or false: Loggers default to outputting log records for all log levels.
57. How do you obtain a logger?
58. How do you obtain a logger's nearest parent logger?
59. Identify the four categories of message-logging methods.
60. At what log level do the `entering()` and `exiting()` methods log messages?
61. How do you change a logger's log level?
62. What method does the `Filter` interface provide for further filtering log records regardless of their log levels?
63. How do you obtain the name of the method that's the source of a log record?

64. How does the logging framework send a log record to its ultimate destination (such as the console)?
65. How do you obtain a logger's registered handlers?
66. True or false: `FileHandler`'s default formatter is an instance of `SimpleFormatter`.
67. What does the `LogManager` class accomplish?
68. Explain the need for the `ErrorManager` class.
69. What does the Preferences API let you accomplish?
70. How does the Preferences API manage preferences?
71. What is the difference between the system preference tree and the user preference tree?
72. Identify the package assigned to the Preferences API and list its members.
73. Which one of the Preferences API's types is the entry point?
74. How do you obtain the root node of the system preference tree?
75. What does the `Runtime` class accomplish, and how do you obtain an instance of this class?
76. What does `Runtime` provide for executing other applications?
77. Define Java Native Interface.
78. What is a hybrid library?
79. What does the JNI do when you try to load a nonexistent library?
80. Identify the package for working with ZIP archives.
81. Each stored file in a ZIP archive is known as what?
82. True or false: The name of a stored file in a ZIP archive cannot exceed 65,536 bytes.
83. What does `ZipOutputStream` accomplish?
84. What does `ZipInputStream` accomplish?
85. Which class appears to be an alias for `ZipInputStream`?
86. Identify the package for working with JAR files.
87. Define manifest.
88. True or false: When creating a manifest for a JAR output stream, you must store `MANIFEST_VERSION`; otherwise, you'll observe a thrown exception at runtime.
89. Create a `SpanishCollation` application that outputs Spanish words ñango (weak), llamado (called), lunes (Monday), champán (champagne), clamor (outcry), cerca (near), nombre (name), and chiste (joke) according to this language's current collation rules followed by its traditional collation rules. According to the current collation rules, the output order is as follows: cerca, champán, chiste, clamor, llamado, lunes, nombre, and ñango. According to the traditional collation rules, the output order is as follows: cerca, clamor, champán, chiste, lunes, llamado, nombre, and ñango. Use the `RuleBasedCollator` class to specify the rules for traditional collation. Also, construct your `Locale` object using only the es (Spanish) language code.

**Note** The Spanish alphabet consists of 29 letters: a, b, c, ch, d, e, f, g, h, i, j, k, l, ll, m, n, ñ, o, p, q, r, s, t, u, v, w, x, y, z. (Vowels are often written with accents, as in *tablón* [plank or board], and u is sometimes topped with a dieresis or umlaut, as in *vergüenza* [bashfulness]. However, vowels with these diacritical marks are not considered separate letters.) Before April 1994's voting at the X Congress of the Association of Spanish Language Academies, ch was collated after c, and ll was collated after l. Because this congress adopted the standard Latin alphabet collation rules, ch is now considered a sequence of two distinct characters and dictionaries now place words starting with ch between words starting with cg and ci. Similarly, ll is now considered a sequence of two characters.

90. Create a `ZipList` application that's similar to `ZipAccess` but only outputs information about the archive; it doesn't extract file contents as well. Information to be output is the name of the entry, the compressed and uncompressed sizes, and the last modification time. Use the `Date` class to convert the last modification time to a human-readable string.

## Summary

Apache Harmony is the basis for the core of Android's standard class library, which is why Android doesn't support Java language features more recent than Java 5 and APIs more recent than Java 6. However, it's possible to add this support.

Java hasn't stopped evolving, and version 7 introduced several new language features that will be helpful to Android app developers. These features range from the small (adding underscores to integer literals, for example) to the more significant (such as automatic resource management).

The virtual machine relies on classloaders to dynamically load compiled classes and other reference types (classes, for short) from classfiles, JAR files, URLs, and other sources into memory. Classloaders insulate the virtual machine from filesystems, networks, and so on.

When the virtual machine starts running, bootstrap, extension, and system classloaders are available. Also, the standard class library provides the abstract `ClassLoader` class as the ultimate root class for all classloaders (including extension and system) except for bootstrap.

`ClassLoader` is subclassed by the concrete `SecureClassLoader` class, which takes security information into account. `SecureClassLoader` is subclassed by the concrete `URLClassLoader` class, which lets you load classes and resources from a search path of URLs referring to JAR files and directories.

Starting with Java 1.2, classloaders have a hierarchical relationship in which each classloader except for bootstrap has a parent classloader. The bootstrap classloader is the root classloader in much the same way as `Object` is the root reference type.

Java also recognizes current and context classloaders. The current classloader is the classloader that loads the class to which the currently executing method belongs. The context classloader (introduced by Java 1.2) is the classloader associated with the current thread.

Central to `ClassLoader` are its `Class<?> loadClass(String name)` and protected `Class<?> loadClass(String name, boolean resolve)` methods, which try to load the class with the specified name. They throw `ClassNotFoundException` when the class cannot be found or return a `Class` object representing the loaded class.

Classloaders are typically used to load classes, but they can also load arbitrary resources (such as images) via `ClassLoader` methods such as `InputStream getResourceAsStream(String name)`. Although you could call these methods directly, it's common practice to work with `Class`'s `URL getResource(String name)` and `InputStream getResourceAsStream(String name)` methods instead.

Java 6 introduced a `Console` class that facilitates the development of console-based applications. For example, `Console` provides a `readPassword()` method for prompting the user to enter a password without echoing the password to the screen.

Designing significant applications is often difficult and prone to error. Over the years, developers have encountered various design problems and have devised clever solutions. These problems and their solutions have been catalogued to help other developers detect them and avoid reinventing solutions. These catalogued entities are known as design patterns.

A design pattern is a catalogued problem/solution entity. It consists of a name describing the pattern and a vocabulary for discussing it with other developers, a clear statement of the problem that the design pattern solves, a solution in terms of the classes and objects and their relationships and other factors that solve the problem, and the consequences of using the pattern.

Double brace initialization is a special syntax for initializing a newly created object in a compact manner, for example, `new Office() {{addEmployee(new Employee("John Doe"));}}`. Because this syntax sugar is based on an anonymous class, one drawback with this technique is a bloated number of classfiles. A second drawback: you cannot use Java 7's diamond operator.

Method chaining is used to construct fluent interfaces, which are implementations of object-oriented APIs that provide for more readable code. A fluent interface is normally implemented via method chaining to relay the instruction context of a subsequent method call. The context is defined through the return value of a called method, the context is self-referential in that the new context is equivalent to the last context, and the context is terminated through the return of a void context.

The `final` keyword plays a large role in the creation of immutable classes, which are classes whose instances cannot be modified. Immutable classes offer several advantages, which is why you might consider designing most of your classes to be immutable. Most importantly, objects created from immutable classes are thread-safe and there are no synchronization issues.

There are several guidelines that must be followed to ensure that a class is immutable: don't include setter or other mutator methods in the class design, prevent methods from being overridden (typically by marking the class `final`), declare all fields `final`, and prevent the class from exposing any mutable state.

Internationalization is the process of creating an application that automatically adapts to its current user's culture (without recompilation) so that the user can read text in the user's language and otherwise interact with the application without observing cultural issues. Related to internationalization is localization, which is the adaptation of internationalized software to support a new culture by adding culture-specific elements (such as text strings that have been translated to the culture).



The `Locale` class is the centerpiece of the various Internationalization APIs. Instances of this class represent locales, which are geographical, political, or cultural regions.

An internationalized application contains no hard-coded text or other locale-specific elements (such as a specific currency format). Instead, each supported locale's version of these elements is stored outside of the application. Java is responsible for storing each locale's version of certain elements, such as currency formats. In contrast, it's your responsibility to store each supported locale's version of other elements, such as text, audio clips, and locale-sensitive images. These elements are typically stored in resource bundles, which are containers that store locale-specific elements.

Java distinguishes between property resource bundles, which are backed by text-based properties files, and list resource bundles, which are Java classes that extend `ListResourceBundle`, and which can contain binary data.

Internationalized text-processing applications need to detect logical boundaries within the text they're manipulating. For example, a word processor needs to detect these boundaries when highlighting a character, selecting a word to cut to the clipboard, moving the caret (text insertion point indicator) to the start of the next sentence, and wrapping a word at the end of a line. Java provides the `BreakIterator` API with its abstract `BreakIterator` entry-point class to detect text boundaries.

Applications perform string comparisons while sorting text. When an application targets English-oriented users, `String`'s `compareTo()` method is probably sufficient for comparing strings. However, this method's binary comparison of each string's Unicode characters isn't reliable for languages where the relative order of their characters doesn't correspond to the Unicode values of these characters. French is one example. Java provides the `Collator` API with its abstract `Collator` entry-point class for making reliable comparisons.

Internationalized applications must properly handle dates, time zones, and calendars. A date is a recorded temporal moment, a time zone is a set of geographical regions that share a common number of hours relative to Greenwich Mean Time (GMT), and a calendar is a system of organizing the passage of time.

Java 1.0 introduced the `Date` class as its first attempt to describe calendars. However, `Date` was not amenable to internationalization because of its English-oriented nature and because of its inability to represent dates prior to midnight January 1, 1970 GMT, which is known as the Unix epoch (the date when Unix began to be used).

`Date`'s `toString()` method reveals that a time zone is part of a date. Java provides the abstract `TimeZone` entry-point class for obtaining instances of `TimeZone` subclasses.

Java 1.1 introduced the `Calendar` API with its abstract `Calendar` entry-point class as a replacement for `Date`. `Calendar` is intended to represent any kind of calendar. However, time constraints meant that only the Gregorian calendar could be implemented (via the concrete `GregorianCalendar` subclass) for version 1.1.

Internationalized applications don't present unformatted numbers (including currencies and percentages), dates, and messages to the user. These items must be formatted according to the user's locale so that they appear meaningful. To help with formatting, Java provides the abstract `Format` class and various subclasses.

The abstract `NumberFormat` entry-point class declares class methods to return formatters that format numbers as currencies, integers, numbers with decimal points, and percentages (and also to parse such values). The abstract `DateFormat` entry-point class provides access to formatters that format `Date` instances as dates or time values (and also to parse such values). The concrete `MessageFormat` class lets you format simple and compound messages. For a simple message, you obtain its text from a resource bundle and then display this text to the user. For a compound message, you obtain a pattern (template) for the message from a property resource bundle, pass this pattern and the variable data to a message formatter to create a simple message, and display this message's text.

In Chapter 5, I presented a simple logging framework to demonstrate packages. Creating your own logging framework is typically a waste of time, and you should use the standard `java.util.logging` package instead. This package implements Java's Logging API, which was introduced in Java 1.4.

The `java.util.logging` package consists of 2 interfaces and 15 classes. This package's key types include `Logger` (the entry-point into the Logging API; it lets you log messages to various destinations such as files or the console), `LogRecord` (a description of a message as a record; used to pass messages between the logging framework and individual `Handlers`), `Handler` (a receiver of messages from `Logger` and a publisher of these messages to a console, a file, a network logging service, and so on), `Level` (a set of standard log levels that can be used to control logging output), `Filter` (an interface that provides fine-grain control over what is logged, beyond the control provided by log levels), and `Formatter` (an infrastructure for formatting `LogRecords` into strings).

Significant applications have preferences, which are configuration items. The Preferences API lets you store preferences in a hierarchical manner so that you can avoid name collisions. Because this API is backend-neutral, it doesn't matter where the preferences are stored (a file, a database, or [on Windows platforms] the registry); you don't have to hardcode file names and locations. Also, there are no text files that can be modified, and Preferences can be used on diskless platforms.

This API uses trees of nodes to manage preferences. These nodes are the analogue of a hierarchical filesystem's directories. Also, preference name/value pairs stored under these nodes are the analogues of a directory's files. You navigate these trees in a similar manner to navigating a filesystem: specify an absolute path starting from the root node (`/`) to the node of interest, such as `/window/location` and `/window/size`.

There are two kinds of trees: system and user. All users share the system preference tree, whereas the user preference tree is specific to a single user, which is generally the person who logged into the underlying platform. (The precise description of "user" and "system" varies from implementation to implementation of the Preferences API.)

Although the Preferences API's `java.util.prefs` package contains three interfaces (`NodeChangeListener`, `PreferencesChangeListener`, and `PreferencesFactory`), four regular classes (`AbstractPreferences`, `NodeChangeEvent`, `PreferenceChangeEvent`, and `Preferences`), and two exception classes (`BackingStoreException` and `InvalidPreferencesFormatException`), you mostly work with the `Preferences` class.

The `Runtime` class provides Java applications with access to their runtime environment. An instance of this class is obtained by invoking its `Runtime` `getRuntime()` class method.

Runtime declares several methods that are also declared in System. For example, Runtime declares a `void gc()` method. Behind the scenes, System defers to its Runtime counterpart by first obtaining the Runtime instance and then invoking this method via that instance. For example, System's static `void gc()` method executes `Runtime.getRuntime().gc();`

Some of Runtime's methods are dedicated to executing other applications. For example, `Process exec(String program)` executes the program named `program` in a separate native process. The new process inherits the environment of the method's caller, and a `Process` object is returned to allow communication with the new process. `IOException` is thrown when an I/O error occurs.

The Java Native Interface is a native programming interface that lets Java code running in a virtual machine interoperate with native libraries written in other languages (such as C, C++, or even assembly language). The JNI is a bridge between the virtual machine and the underlying platform.

The `java.util.zip` package provides classes for working with ZIP files, which are also known as ZIP archives. Each ZIP archive stores files that are typically compressed, and each stored file is known as a ZIP entry. You can use these classes to write ZIP entries to or read ZIP entries from a ZIP archive in the standard ZIP and GZIP (GNU ZIP) file formats, compress and decompress data via the DEFLATE compression algorithm that these formats use, and compute the CRC-32 and Adler-32 checksums of arbitrary input streams.

The `java.util.jar` package provides classes for working with JAR files. Because a JAR file is a kind of ZIP file, it isn't surprising that this package provides classes that extend their `java.util.zip` counterparts. For example, `JarEntry` extends `ZipEntry`.

The `java.util.jar` package also provides classes that have no `java.util.zip` counterparts, such as `Manifest`. These classes provide access to JAR-specific capabilities. For example, `Manifest` lets you work with a JAR file's manifest.

Now that you've reached the end of this chapter, check out Appendixes A and B, which offer solutions to all exercises in Chapters 1 through 16 and introduce you to a card game application.

# Solutions to Exercises

Each of Chapters 1 through 16 closes with an “Exercises” section that tests your understanding of the chapter’s material. Solutions to these exercises are presented in this appendix.

## Chapter 1: Getting Started with Java

1. Java is a language and a platform. The language is partly patterned after the C and C++ languages to shorten the learning curve for C/C++ developers. The platform consists of a virtual machine and an associated execution environment.
2. A virtual machine is a software-based processor that presents its own instruction set.
3. The purpose of the Java compiler is to translate source code into instructions (and associated data) that are executed by the virtual machine.
4. The answer is true: a classfile’s instructions are commonly referred to as bytecode.
5. When the JVM’s interpreter learns that a sequence of bytecode instructions is being executed repeatedly, it informs the JVM’s just-in-time (JIT) compiler to compile these instructions into native code.
6. The Java platform promotes portability by providing an abstraction over the underlying platform. As a result, the same bytecode runs unchanged on Windows-based, Linux-based, Mac OS X-based, and other platforms.
7. The Java platform promotes security by doing its best to provide a secure environment in which code executes. It accomplishes this task in part by using a bytecode verifier to make sure that the classfile’s bytecode is valid.

8. The answer is false: Java SE is the platform for developing applications and applets.
9. The JRE implements the Java SE platform and makes it possible to run Java programs.
10. The difference between the public and private JREs is that the public JRE exists apart from the JDK, whereas the private JRE is a component of the JDK that makes it possible to run Java programs independently of whether or not the public JRE is installed.
11. The JDK is a software development kit that provides tools (including a compiler) for developing Java programs. It also provides a private JRE for running these programs.
12. The JDK's `javac` tool is used to compile Java source code.
13. The JDK's `java` tool is used to run Java applications.
14. Standard I/O is a mechanism consisting of Standard Input, Standard Output, and Standard Error that makes it possible to read text from different sources (keyboard or file), write nonerror text to different destinations (screen or file), and write error text to different destinations (screen or file).
15. You specify the `main()` method's header as `public static void main(String[] args)`.
16. An IDE is a development framework consisting of a project manager for managing a project's files, a text editor for entering and editing source code, a debugger for locating bugs, and other features. The IDE that Google supports for developing Android apps is Eclipse.
17. Android is Google's software stack for mobile devices. This stack consists of apps (such as Browser and Contacts), a virtual machine in which apps run, middleware (software that sits on top of the operating system and provides various services to the virtual machine and its apps), and a Linux-based operating system.
18. The API level associated with Android 4.4 is 19.
19. The DEX format is Android's executable format for apps. DEX is optimized for a minimal memory footprint.
20. Android uses the `dx` tool to transform compiled Java classfiles into the DEX format.

## Chapter 2: Learning Language Fundamentals

1. Unicode is a computing industry standard for consistently encoding, representing, and handling text that's expressed in most of the world's writing systems.
2. A comment is a language feature for embedding documentation in source code.
3. The three kinds of comments that Java supports are single-line, multiline, and Javadoc.
4. An identifier is a language feature that consists of letters (A-Z, a-z, or equivalent uppercase/lowercase letters in other human alphabets), digits (0-9 or equivalent digits in other human alphabets), connecting punctuation characters (such as the underscore), and currency symbols (such as the dollar sign, \$). This name must begin with a letter, a currency symbol, or a connecting punctuation character; and its length cannot exceed the line in which it appears.
5. The answer is false: Java is a case-sensitive language.
6. A type is a language feature that identifies a set of values (and their representation in memory) and a set of operations that transform these values into other values of that set.
7. A primitive-type is a type that's defined by the language and whose values are not objects.
8. Java supports the Boolean, character, byte integer, short integer, integer, long integer, floating-point, and double precision floating-point primitive-types.
9. A user-defined type is a type that's defined by the developer using a class, an interface, an enum, or an annotation type and whose values are objects.
10. An array type is a special reference type that signifies an array, a region of memory that stores values in equal-size and contiguous slots, which are commonly referred to as elements.
11. A variable is a named memory location that stores some type of value.
12. An expression is a combination of literals, variable names, method calls, and operators. At runtime, it evaluates to a value whose type is referred to as the expression's type.
13. The two expression categories are simple expression and compound expression.
14. A literal is a value specified verbatim.

15. String literal "The quick brown fox \jumps\ over the lazy dog." is illegal because, unlike \", \j and \ (a backslash followed by a space character) are not valid escape sequences. To make this string literal legal, you must escape these backslashes, as in "The quick brown fox \\jumps\\ over the lazy dog."
16. An operator is a sequence of instructions symbolically represented in source code.
17. The difference between a prefix operator and a postfix operator is that a prefix operator precedes its operand and a postfix operator trails its operand.
18. The purpose of the cast operator is to convert from one type to another type. For example, you can use this operator to convert from floating-point type to 32-bit integer type.
19. Precedence refers to an operator's level of importance.
20. The answer is true: most of Java's operators are left-to-right associative.
21. A statement is a language feature that assigns a value to a variable, controls a program's flow by making a decision and/or repeatedly executing another statement, or performs another task.
22. The difference between the while and do-while statements is that the while statement evaluates its Boolean expression at the top of the loop, whereas the do-while statement evaluates its Boolean expression at the bottom of the loop. As a result, while executes zero or more times, whereas do-while executes one or more times.
23. The difference between the break and continue statements is that break transfers execution to the first statement following a switch statement or a loop, whereas continue skips the remainder of the current loop iteration, reevaluates the loop's Boolean expression, and performs another iteration (when true) or terminates the loop (when false).
24. Listing A-1 presents the Compass application that was called for in Chapter 2.

*Listing A-1. Finding a Direction in Which to Travel*

```
public class Compass
{
    public static void main(String[] args)
    {
        int direction = 1;
        switch (direction)
        {
            case 0: System.out.println("You are travelling north."); break;
            case 1: System.out.println("You are travelling east."); break;
            case 2: System.out.println("You are travelling south."); break;
        }
    }
}
```

```

        case 3: System.out.println("You are travelling west."); break;
        default: System.out.println("You are lost.");
    }
}
}

```

25. Listing A-2 presents the Triangle application that was called for in Chapter 2.

*Listing A-2. Printing a Triangle of Asterisks*

```

public class Triangle
{
    public static void main(String[] args)
    {
        for (int row = 1; row < 20; row += 2)
        {
            for (int col = 0; col < 19 - row / 2; col++)
                System.out.print(" ");
            for (int col = 0; col < row; col++)
                System.out.print("*");
            System.out.print('\n');
        }
    }
}

```

26. Listing A-3 presents the first PromptForC application that was called for in Chapter 2.

*Listing A-3. Looping Until the User Enters C or c (Version 1)*

```

public class PromptForC
{
    public static void main(String[] args) throws java.io.IOException
    {
        int ch = 0;
        while (ch != 'C' && ch != 'c')
        {
            System.out.println("Press C or c to continue.");
            ch = System.in.read();
        }
    }
}

```

Listing A-4 presents the second PromptForC application that was called for in Chapter 2.

*Listing A-4. Looping Until the User Enters C or c (Version 2)*

```

public class PromptForC
{
    public static void main(String[] args) throws java.io.IOException
    {
        int ch;

```



```
do
{
    System.out.println("Press C or c to continue.");
    ch = System.in.read();
}
while (ch != 'C' && ch != 'c');
}
```

## Chapter 3: Discovering Classes and Objects

1. A class is a container for housing an application and is also a template for manufacturing objects.
2. You declare a class by minimally specifying reserved word `class` followed by a name that identifies the class (so that it can be referred to from elsewhere in the source code), followed by a body. The body starts with an open brace character (`{`) and ends with a close brace (`}`). Sandwiched between these delimiters are various kinds of member declarations.
3. The answer is false: you can declare only one public class in a source file.
4. An object is an instance of a class.
5. You obtain an object by using the `new` operator to allocate memory to store a class instance and a constructor to initialize this instance.
6. A constructor is a block of code for constructing an object by initializing it in some manner.
7. The answer is true: Java creates a default noargument constructor when a class declares no constructors.
8. A parameter list is a round bracket-delimited and comma-separated list of zero or more parameter declarations. A parameter is a constructor or method variable that receives an expression value passed to the constructor or method when it's called.
9. An argument list is a round bracket-delimited and comma-separated list of zero or more expressions. An argument is one of these expressions whose value is passed to the corresponding parameter when a constructor or method is called.
10. The answer is false: you invoke another constructor by specifying `this` followed by an argument list.
11. Arity is the number of arguments passed to a constructor or method or the number of operator operands.

12. A local variable is a variable that's declared in a constructor or method and isn't a member of the constructor or method parameter list.
13. Lifetime is a property of a variable that determines how long the variable exists. For example, parameters come into existence when a constructor or method is called and are destroyed when the constructor or method finishes. Similarly, an instance field comes into existence when an object is created and is destroyed when the object is garbage collected.
14. Scope is a property of a variable that determines how accessible the variable is to code. For example, a parameter can be accessed only by the code within the constructor or method in which the parameter is declared.
15. Encapsulation refers to the merging of state and behaviors into a single source code entity. Instead of separating state and behaviors, which is done in structured programs, state and behaviors are combined into classes and objects, which are the focus of object-based programs. For example, where a structured program makes you think in terms of separate balance state and deposit/withdraw behaviors, an object-based program makes you think in terms of bank accounts, which unite balance state with deposit/withdraw behaviors through encapsulation.
16. A field is a variable declared within a class body.
17. The difference between an instance field and a class field is that an instance field describes some attribute of the real-world entity that an object is modeling and is unique to each object, and a class field identifies some data item that's shared by all objects.
18. A blank final is a read-only instance field. It differs from a true constant in that there are multiple copies of blank finals (one per object) and only one true constant (one per class).
19. You prevent a field from being shadowed by changing the name of a same-named local variable or parameter, or by qualifying the local variable's name or parameter's name with `this` or the class name followed by the member access operator.
20. A method is a named block of code declared within a class body.
21. The difference between an instance method and a class method is that an instance method describes some behavior of the real-world entity that an object is modeling and can access a specific object's state, whereas a class method identifies some behavior that's common to all objects and cannot access a specific object's state.
22. Recursion is the act of a method invoking itself.
23. You overload a method by introducing a method with the same name as an existing method but with a different parameter list into the same class.

24. A class initializer is a static-prefixed block that's introduced into a class body. An instance initializer is a block that's introduced into a class body as opposed to being introduced as the body of a method or a constructor.
25. A garbage collector is code that runs in the background and occasionally checks for unreferenced objects.
26. An object graph is a hierarchy of all of the objects currently stored in the heap.
27. The answer is false: `String[] letters = new String[2] { "A", "B" };` is incorrect syntax. Remove the 2 from between the square brackets to make it correct.
28. A ragged array is a two-dimensional array in which each row can have a different number of columns.
29. Listing A-5 presents the Image application that was called for in Chapter 3.

*Listing A-5. Testing the Image Class*

```
public class Image
{
    Image()
    {
        System.out.println("Image() called");
    }

    Image(String filename)
    {
        this(filename, null);
        System.out.println("Image(String filename) called");
    }

    Image(String filename, String imageType)
    {
        System.out.println("Image(String filename, String imageType) called");
        if (filename != null)
        {
            System.out.println("reading " + filename);
            if (imageType != null)
                System.out.println("interpreting " + filename + " as storing a " +
                    imageType + " image");
        }
        // Perform other initialization here.
    }

    public static void main(String[] args)
    {
        Image image = new Image();
        System.out.println();
        image = new Image("image.png");
    }
}
```

```

        System.out.println();
        image = new Image("image.png", "PNG");
    }
}

```

30. Listing A-6 presents the Conversions application that was called for in Chapter 3.

*Listing A-6. Converting Between Degrees Fahrenheit and Degrees Celsius*

```

public class Conversions
{
    static double c2f(double degrees)
    {
        return degrees * 9.0 / 5.0 + 32;
    }

    static double f2c(double degrees)
    {
        return (degrees - 32) * 5.0 / 9.0;
    }

    public static void main(String[] args)
    {
        System.out.println("Fahrenheit equivalent of 100 degrees Celsius is " +
            Conversions.c2f(100));
        System.out.println("Celsius equivalent of 98.6 degrees Fahrenheit is " +
            Conversions.f2c(98.6));
        System.out.println("Celsius equivalent of 32 degrees Fahrenheit is " +
            f2c(32));
    }
}

```

31. Listing A-7 presents the Utilities application that was called for in Chapter 3.

*Listing A-7. Calculating Factorials and Summing a Variable Number of Double Precision Floating-Point Values*

```

public class Utilities
{
    static int factorial1(int n)
    {
        int product = 1;
        for (int i = 2; i <= n; i++)
            product *= i;
        return product;
    }

    static int factorial2(int n)
    {
        if (n == 0 || n == 1)
            return 1; // base problem
    }
}

```

```
    else
        return n * factorial2(n - 1);
}

static double sum(double... values)
{
    int total = 0;
    for (int i = 0; i < values.length; i++)
        total += values[i];
    return total;
}

public static void main(String[] args)
{
    System.out.println(factorial1(4));
    System.out.println(factorial2(4));
    System.out.println(factorial2(0));
    System.out.println(factorial2(1));
    System.out.println(sum(10.0, 20.0));
    System.out.println(sum(30.0, 40.0, 50.0));
}
}
```

32. Listing A-8 presents the GCD application that was called for in Chapter 3.

*Listing A-8. Recursively Calculating the Greatest Common Divisor*

```
public class GCD
{
    public static int gcd(int a, int b)
    {
        // The greatest common divisor is the largest positive integer that
        // divides evenly into two positive integers a and b. For example,
        // GCD(12, 18) is 6.

        if (b == 0) // Base problem
            return a;
        else
            return gcd(b, a % b);
    }

    public static void main(String[] args)
    {
        System.out.println(gcd(12, 18));
    }
}
```

33. Listing A-9 presents the Book application that was called for in Chapter 3.

*Listing A-9. Building a Library of Books*

```
public class Book
{
    private String name;
    private String author;
    private String isbn;

    public Book(String name, String author, String isbn)
    {
        this.name = name;
        this.author = author;
        this.isbn = isbn;
    }

    public String getName()
    {
        return name;
    }

    public String getAuthor()
    {
        return author;
    }

    public String getISBN()
    {
        return isbn;
    }

    public static void main(String[] args)
    {
        Book[] books = new Book[]
        {
            new Book("Jane Eyre",
                    "Charlotte Brontë",
                    "0895772000"),
            new Book("A Kick in the Seat of the Pants",
                    "Roger von Oech",
                    "0060155280"),
            new Book("The Prince and the Pilgrim",
                    "Mary Stewart",
                    "0340649925")
        };
        for (int i = 0; i < books.length; i++)
            System.out.println(books[i].getName() + " - " +
                               books[i].getAuthor() + " - " +
                               books[i].getISBN());
    }
}
```

## Chapter 4: Discovering Inheritance, Polymorphism, and Interfaces

1. Implementation inheritance is inheritance through class extension.
2. Java supports implementation inheritance by providing reserved word `extends`.
3. A subclass can have only one superclass because Java doesn't support multiple implementation inheritance.
4. You prevent a class from being subclassed by declaring the class `final`.
5. The answer is false: the `super()` call can only appear in a constructor.
6. If a superclass declares a constructor with one or more parameters, and if a subclass constructor doesn't use `super()` to call that constructor, the compiler reports an error because the subclass constructor attempts to call a nonexistent noargument constructor in the superclass. (When a class doesn't declare any constructors, the compiler creates a constructor with no parameters [a noargument constructor] for that class. Therefore, if the superclass didn't declare any constructors, a noargument constructor would be created for the superclass. Continuing, if the subclass constructor didn't use `super()` to call the superclass constructor, the compiler would insert the call and there would be no error.)
7. An immutable class is a class whose instances cannot be modified.
8. The answer is false: a class cannot inherit constructors.
9. Overriding a method means replacing an inherited method with another method that provides the same signature and the same return type but provides a new implementation.
10. To call a superclass method from its overriding subclass method, prefix the superclass method name with reserved word `super` and the member access operator in the method call.
11. You prevent a method from being overridden by declaring the method `final`.
12. You cannot make an overriding subclass method less accessible than the superclass method it is overriding because subtype polymorphism would not work properly if subclass methods could be made less accessible. Suppose you upcast a subclass instance to superclass type by assigning the instance's reference to a variable of superclass type. Now suppose you specify a superclass method call on the variable. If this method is overridden by the subclass, the subclass version of the method is called. However, if access to the subclass's overriding method's access could be made private, calling this method would break encapsulation; private methods cannot be called directly from outside of their class.

13. You tell the compiler that a method overrides another method by prefixing the overriding method's header with the `@Override` annotation.
14. Java doesn't support multiple implementation inheritance because this form of inheritance can lead to ambiguities.
15. The name of Java's ultimate superclass is `Object`. This class is located in the `java.lang` package.
16. The purpose of the `clone()` method is to duplicate an object without calling a constructor.
17. `Object`'s `clone()` method throws `CloneNotSupportedException` when the class whose instance is to be shallowly cloned doesn't implement the `Cloneable` interface.
18. The difference between shallow copying and deep copying is that shallow copying copies each primitive or reference field's value to its counterpart in the clone, whereas deep copying creates, for each reference field, a new object and assigns its reference to the field. This deep copying process continues recursively for these newly created objects.
19. The `==` operator cannot be used to determine if two objects are logically equivalent because this operator only compares object references and not the contents of these objects.
20. `Object`'s `equals()` method compares the current object's `this` reference to the reference passed as an argument to this method. (When I refer to `Object`'s `equals()` method, I am referring to the `equals()` method in the `Object` class.)
21. Expression `"abc" == "a" + "bc"` returns `true`. It does so because the `String` class contains special support that allows literal strings and string-valued constant expressions to be compared via `==`.
22. You can optimize a time-consuming `equals()` method by first using `==` to determine if this method's reference argument identifies the current object (which is represented in source code via reserved word `this`).
23. The purpose of the `finalize()` method is to provide a safety net for calling an object's cleanup method in case that method isn't called.
24. You shouldn't rely on `finalize()` for closing open files because file descriptors are a limited resource and an application might not be able to open additional files until `finalize()` is called, and this method might be called infrequently (or perhaps not at all).
25. A hash code is a small value that results from applying a mathematical function to a potentially large amount of data.



26. The answer is true: you should override the `hashCode()` method whenever you override the `equals()` method.
27. `Object`'s `toString()` method returns a string representation of the current object that consists of the object's class name, followed by the `@` symbol, followed by a hexadecimal representation of the object's hash code. (When I refer to `Object`'s `toString()` method, I'm referring to the `toString()` method in the `Object` class.)
28. You should override `toString()` to provide a concise but meaningful description of the object to facilitate debugging via `System.out.println()` method calls. It's more informative for `toString()` to reveal object state than to reveal a class name, followed by the `@` symbol, followed by a hexadecimal representation of the object's hash code.
29. Composition is a way to reuse code by composing classes out of other classes based on a "has-a" relationship between them.
30. The answer is false: composition is used to describe "has-a" relationships and implementation inheritance is used to describe "is-a" relationships.
31. The fundamental problem of implementation inheritance is that it breaks encapsulation. You fix this problem by ensuring that you have control over the superclass as well as its subclasses, by ensuring that the superclass is designed and documented for extension, or by using a wrapper class in lieu of a subclass when you would otherwise extend the superclass.
32. Subtype polymorphism is a kind of polymorphism where a subtype instance appears in a supertype context, and executing a supertype operation on the subtype instance results in the subtype's version of that operation executing.
33. Subtype polymorphism is accomplished by upcasting the subtype instance to its supertype; by assigning the instance's reference to a variable of that type; and, via this variable, calling a superclass method that's been overridden in the subclass.
34. You would use abstract classes and abstract methods to describe generic concepts (such as shape, animal, or vehicle) and generic operations (such as drawing a generic shape). Abstract classes cannot be instantiated and abstract methods cannot be called because they have no code bodies.
35. An abstract class can contain concrete methods.
36. The purpose of downcasting is to access subtype features. For example, you would downcast a `Point` variable that contains a `Circle` instance reference to the `Circle` type so that you can call `Circle`'s `getRadius()` method on the instance.

37. Two forms of RTTI are the virtual machine verifying that a cast is legal and using the `instanceof` operator to determine whether or not an instance is a member of a type.
38. A covariant return type is a method return type that, in the superclass's method declaration, is the supertype of the return type in the subclass's overriding method declaration.
39. You formally declare an interface by specifying at least reserved word `interface`, followed by a name, followed by a brace-delimited body of constants and/or method headers.
40. The answer is true: you can precede an interface declaration with the `abstract` reserved word. However, doing so is redundant.
41. A marker interface is an interface that declares no members.
42. Interface inheritance is inheritance through interface implementation or interface extension.
43. You implement an interface by appending an `implements` clause, consisting of reserved word `implements` followed by the interface's name, to a class header and by overriding the interface's method headers in the class.
44. You might encounter one or more name collisions when you implement multiple interfaces.
45. You form a hierarchy of interfaces by appending reserved word `extends` followed by an interface name to an interface header.
46. Java's interfaces feature is so important because it gives developers the utmost flexibility in designing their applications.
47. Interfaces and abstract classes describe abstract types.
48. Interfaces and abstract classes differ in that interfaces can only declare abstract methods and constants and can be implemented by any class in any class hierarchy. In contrast, abstract classes can declare constants and nonconstant fields; can declare abstract and concrete methods; and can only appear in the upper levels of class hierarchies, where they're used to describe abstract concepts and behaviors.
49. Listings A-10 through A-16 declare the `Animal`, `Bird`, `Fish`, `AmericanRobin`, `DomesticCanary`, `RainbowTrout`, and `SockeyeSalmon` classes that were called for in Chapter 4.

*Listing A-10. The Animal Class Abstracting Over Birds and Fish (and Other Organisms)*

```
public abstract class Animal
{
    private String kind;
    private String appearance;

    public Animal(String kind, String appearance)
    {
        this.kind = kind;
        this.appearance = appearance;
    }

    public abstract void eat();

    public abstract void move();

    @Override
    public final String toString()
    {
        return kind + " -- " + appearance;
    }
}
```

*Listing A-11. The Bird Class Abstracting Over American Robins, Domestic Canaries, and Other Kinds of Birds*

```
public abstract class Bird extends Animal
{
    public Bird(String kind, String appearance)
    {
        super(kind, appearance);
    }

    @Override
    public final void eat()
    {
        System.out.println("eats seeds and insects");
    }

    @Override
    public final void move()
    {
        System.out.println("flies through the air");
    }
}
```

**Listing A-12. The Fish Class Abstracting Over Rainbow Trout, Sockeye Salmon, and Other Kinds of Fish**

```

public abstract class Fish extends Animal
{
    public Fish(String kind, String appearance)
    {
        super(kind, appearance);
    }

    @Override
    public final void eat()
    {
        System.out.println("eats krill, algae, and insects");
    }

    @Override
    public final void move()
    {
        System.out.println("swims through the water");
    }
}

```

**Listing A-13. The AmericanRobin Class Denoting a Bird with a Red Breast**

```

public final class AmericanRobin extends Bird
{
    public AmericanRobin()
    {
        super("americanrobin", "red breast");
    }
}

```

**Listing A-14. The DomesticCanary Class Denoting a Bird of Various Colors**

```

public final class DomesticCanary extends Bird
{
    public DomesticCanary()
    {
        super("domestic canary", "yellow, orange, black, brown, white, red");
    }
}

```

**Listing A-15. The RainbowTrout Class Denoting a Rainbow-Colored Fish**

```

public final class RainbowTrout extends Fish
{
    public RainbowTrout()
    {
        super("rainbowtrout", "bands of brilliant speckled multicolored " +
            "stripes running nearly the whole length of its body");
    }
}

```

*Listing A-16. The SockeyeSalmon Class Denoting a Red-and-Green Fish*

```
public final class SockeyeSalmon extends Fish
{
    public SockeyeSalmon()
    {
        super("sockeyesalmon", "bright red with a green head");
    }
}
```

Animal's toString() method is declared final because it doesn't make sense to override this method, which is complete in this example. Also, each of Bird's and Fish's overriding eat() and move() methods is declared final because it doesn't make sense to override these methods in this example, which assumes that all birds eat seeds and insects; all fish eat krill, algae, and insects; all birds fly through the air; and all fish swim through the water.

The AmericanRobin, DomesticCanary, RainbowTrout, and SockeyeSalmon classes are declared final because they represent the bottom of the Bird and Fish class hierarchies, and it doesn't make sense to subclass them.

50. Listing A-17 declares the Animals class that was called for in Chapter 4.

*Listing A-17. The Animals Class Letting Animals Eat and Move*

```
public class Animals
{
    public static void main(String[] args)
    {
        Animal[] animals = { new AmericanRobin(), new RainbowTrout(),
                             new DomesticCanary(), new SockeyeSalmon() };
        for (int i = 0; i < animals.length; i++)
        {
            System.out.println(animals[i]);
            animals[i].eat();
            animals[i].move();
            System.out.println();
        }
    }
}
```

51. Listings A-18 through A-20 declare the Countable interface, the modified Animal class, and the modified Animals class that were called for in Chapter 4.

*Listing A-18. The Countable Interface for Use in Taking a Census of Animals*

```
public interface Countable
{
    String getID();
}
```

*Listing A-19. The Refactored Animal Class for Help in Census Taking*

```

public abstract class Animal implements Countable
{
    private String kind;
    private String appearance;

    public Animal(String kind, String appearance)
    {
        this.kind = kind;
        this.appearance = appearance;
    }

    public abstract void eat();

    public abstract void move();

    @Override
    public final String toString()
    {
        return kind + " -- " + appearance;
    }

    @Override
    public final String getID()
    {
        return kind;
    }
}

```

*Listing A-20. The Modified Animals Class for Carrying Out the Census*

```

public class Animals
{
    public static void main(String[] args)
    {
        Animal[] animals = { new AmericanRobin(), new RainbowTrout(),
                             new DomesticCanary(), new SockeyeSalmon(),
                             new RainbowTrout(), new AmericanRobin() };
        for (int i = 0; i < animals.length; i++)
        {
            System.out.println(animals[i]);
            animals[i].eat();
            animals[i].move();
            System.out.println();
        }

        Census census = new Census();
        Countable[] countables = (Countable[]) animals;
        for (int i = 0; i < countables.length; i++)
            census.update(countables[i].getID());
    }
}

```

```
    for (int i = 0; i < Census.SIZE; i++)  
        System.out.println(census.get(i));  
    }  
}
```

## Chapter 5: Mastering Advanced Language Features, Part 1

1. A nested class is a class that's declared as a member of another class or scope.
2. The four kinds of nested classes are static member classes, nonstatic member classes, anonymous classes, and local classes.
3. Nonstatic member classes, anonymous classes, and local classes are also known as inner classes.
4. The answer is false: a static member class doesn't have an enclosing instance.
5. You instantiate a nonstatic member class from beyond its enclosing class by first instantiating the enclosing class and then prefixing the new operator with the enclosing class instance as you instantiate the enclosed class. Example: `new EnclosingClass().new EnclosedClass()`.
6. It's necessary to declare local variables and parameters `final` when they are being accessed by an instance of an anonymous class or a local class.
7. The answer is true: an interface can be declared within a class or within another interface.
8. A package is a unique namespace that can contain a combination of top-level classes, other top-level types, and subpackages.
9. You ensure that package names are unique by specifying your reversed Internet domain name as the top-level package name.
10. A package statement is a statement that identifies the package in which a source file's types are located.
11. The answer is false: you cannot specify multiple package statements in a source file.
12. An import statement is a statement that imports types from a package by telling the compiler where to look for unqualified type names during compilation.
13. You indicate that you want to import multiple types via a single import statement by specifying the wildcard character (\*).
14. During a runtime search, the virtual machine reports a "no class definition found" error when it cannot find a classfile.

15. You specify the user classpath to the virtual machine via the `-classpath` (or `-cp`) option used to start the virtual machine or, when not present, the `CLASSPATH` environment variable.
16. A constant interface is an interface that only exports constants.
17. Constant interfaces are used to avoid having to qualify their names with their classes.
18. Constant interfaces are bad because their constants are nothing more than an implementation detail that shouldn't be allowed to leak into the class's exported interface because they might confuse the class's users (what's the purpose of these constants?). Also, they represent a future commitment: even when the class no longer uses these constants, the interface must remain to ensure binary compatibility.
19. A static import statement is a version of the import statement that lets you import a class's static members so that you don't have to qualify them with their class names.
20. You specify a static import statement as `import`, followed by `static`, followed by a member access operator-separated list of package and subpackage names, followed by the member access operator, followed by a class's name, followed by the member access operator, followed by a single static member name or the asterisk wildcard, for example, `import static java.lang.Math.cos;` (import the `cos()` static method from the `Math` class).
21. An exception is a divergence from an application's normal behavior.
22. Objects are superior to error codes for representing exceptions because error code Boolean or integer values are less meaningful than object names and because objects can contain information about what led to the exception. These details can be helpful to a suitable workaround. Furthermore, error codes are easy to ignore.
23. A throwable is an instance of `Throwable` or one of its subclasses.
24. The `getCause()` method returns an exception that's wrapped inside another exception.
25. `Exception` describes exceptions that result from external factors (such as not being able to open a file) and from flawed code (such as passing an illegal argument to a method). `Error` describes virtual machine-oriented exceptions such as running out of memory or being unable to load a classfile.
26. A checked exception is an exception that represents a problem with the possibility of recovery and for which the developer must provide a workaround.



27. A runtime exception is an exception that represents a coding mistake.
28. You would introduce your own exception class when no existing exception class in the standard class library meets your needs.
29. The answer is false: you use a throws clause to identify exceptions that are thrown from a method by appending this clause to a method's header.
30. The purpose of a try statement is to provide a scope (via its brace-delimited body) in which to present code that can throw exceptions. The purpose of a catch block is to receive a thrown exception and provide code (via its brace-delimited body) that handles that exception by providing a workaround.
31. The purpose of a finally block is to provide cleanup code that's executed whether an exception is thrown or not.
32. Listing A-21 presents the G2D class that was called for in Chapter 5.

*Listing A-21. The G2D Class with Its Matrix Nonstatic Member Class*

```
public class G2D
{
    private Matrix xform;

    public G2D()
    {
        xform = new Matrix();
        xform.a = 1.0;
        xform.e = 1.0;
        xform.i = 1.0;
    }

    private class Matrix
    {
        double a, b, c;
        double d, e, f;
        double g, h, i;
    }
}
```

33. To extend the logging package (presented in Chapter 5's discussion of packages) to support a null device in which messages are thrown away, first introduce Listing A-22's NullDevice package-private class.

*Listing A-22. Implementing the Proverbial "Bit Bucket" Class*

```
package logging;

class NullDevice implements Logger
{
    private String dstName;
```

```

NullDevice(String dstName)
{
}

public boolean connect()
{
    return true;
}

public boolean disconnect()
{
    return true;
}

public boolean log(String msg)
{
    return true;
}
}

```

Continue by introducing, into the `LoggerFactory` class, a `NULLDEVICE` constant and code that instantiates `NullDevice` with a `null` argument—a destination name isn't required—when `newLogger()`'s `dstType` parameter contains this constant's value. Check out Listing A-23.

*Listing A-23. A Refactored LoggerFactory Class*

```

package logging;

public abstract class LoggerFactory
{
    public final static int CONSOLE = 0;
    public final static int FILE = 1;
    public final static int NULLDEVICE = 2;

    public static Logger newLogger(int dstType, String...dstName)
    {
        switch (dstType)
        {
            case CONSOLE : return new Console(dstName.length == 0 ? null
                                                : dstName[0]);
            case FILE    : return new File(dstName.length == 0 ? null
                                           : dstName[0]);
            case NULLDEVICE: return new NullDevice(null);
            default      : return null;
        }
    }
}

```

34. Modifying the logging package (presented in Chapter 5's discussion of packages) so that `Logger`'s `connect()` method throws a `CannotConnectException` instance when it cannot connect to its logging destination, and the other two methods each throw a `NotConnectedException` instance when `connect()` was not called or when it threw a `CannotConnectException` instance, results in Listing A-24's `Logger` interface.

*Listing A-24. A Logger Interface Whose Methods Throw Exceptions*

```
package logging;

public interface Logger
{
    void connect() throws CannotConnectException;
    void disconnect() throws NotConnectedException;
    void log(String msg) throws NotConnectedException;
}
```

Listing A-25 presents the `CannotConnectException` class.

*Listing A-25. An Uncomplicated CannotConnectException Class*

```
package logging;

public class CannotConnectException extends Exception
{
}
```

The `NotConnectedException` class has the same structure but with a different name.

Listing A-26 presents the `Console` class.

*Listing A-26. The Console Class Satisfying Logger's Contract Without Throwing Exceptions*

```
package logging;

class Console implements Logger
{
    private String dstName;

    Console(String dstName)
    {
        this.dstName = dstName;
    }

    public void connect() throws CannotConnectException
    {
    }

    public void disconnect() throws NotConnectedException
    {
    }
}
```

```

public void log(String msg) throws NotConnectedException
{
    System.out.println(msg);
}
}

```

Listing A-27 presents the File class.

*Listing A-27. The File Class Satisfying Logger's Contract by Throwing Exceptions As Necessary*

```

package logging;

class File implements Logger
{
    private String dstName;

    File(String dstName)
    {
        this.dstName = dstName;
    }

    public void connect() throws CannotConnectException
    {
        if (dstName == null)
            throw new CannotConnectException();
    }

    public void disconnect() throws NotConnectedException
    {
        if (dstName == null)
            throw new NotConnectedException();
    }

    public void log(String msg) throws NotConnectedException
    {
        if (dstName == null)
            throw new NotConnectedException();
        System.out.println("writing " + msg + " to file " + dstName);
    }
}

```

35. When you modify TestLogger to respond appropriately to thrown CannotConnectException and NotConnectedException objects, you end up with something similar to Listing A-28.

*Listing A-28. A TestLogger Class That Handles Thrown Exceptions*

```

import logging.*;

public class TestLogger
{
    public static void main(String[] args)

```

```
{
  try
  {
    logger logger = LoggerFactory.newLogger(LoggerFactory.CONSOLE);
    logger.connect();
    logger.log("test message #1");
    logger.disconnect();
  }
  catch (CannotConnectException cce)
  {
    System.err.println("cannot connect to console-based logger");
  }
  catch (NotConnectedException nce)
  {
    System.err.println("not connected to console-based logger");
  }

  try
  {
    logger logger = LoggerFactory.newLogger(LoggerFactory.FILE, "x.txt");
    logger.connect();
    logger.log("test message #2");
    logger.disconnect();
  }
  catch (CannotConnectException cce)
  {
    System.err.println("cannot connect to file-based logger");
  }
  catch (NotConnectedException nce)
  {
    System.err.println("not connected to file-based logger");
  }

  try
  {
    logger logger = LoggerFactory.newLogger(LoggerFactory.FILE);
    logger.connect();
    logger.log("test message #3");
    logger.disconnect();
  }
  catch (CannotConnectException cce)
  {
    System.err.println("cannot connect to file-based logger");
  }
  catch (NotConnectedException nce)
  {
    System.err.println("not connected to file-based logger");
  }
}
}
```

## Chapter 6: Mastering Advanced Language Features, Part 2

1. An assertion is a statement that lets you express an assumption of program correctness via a Boolean expression.
2. You would use assertions to validate internal invariants, control-flow invariants, preconditions, postconditions, and class invariants.
3. The answer is false: specifying the `-ea` command-line option with no argument enables all assertions except for system assertions.
4. An annotation is an instance of an annotation type and associates metadata with an application element. It's expressed in source code by prefixing the type name with the `@` symbol.
5. Constructors, fields, local variables, methods, packages, parameters, and types (annotation, class, enum, and interface) can be annotated.
6. The three compiler-supported annotation types are `Override`, `Deprecated`, and `SuppressWarnings`.
7. You declare an annotation type by specifying the `@` symbol, immediately followed by reserved word `interface`, followed by the type's name, followed by a body.
8. A marker annotation is an instance of an annotation type that supplies no data apart from its name; the type's body is empty.
9. An element is a method header that appears in the annotation type's body. It cannot have parameters or a throws clause. Its return type must be primitive (such as `int`), `String`, `Class`, an enum type, an annotation type, or an array of the preceding types. It can have a default value.
10. You assign a default value to an element by specifying `default` followed by the value, whose type must match the element's return type. For example, `String developer() default "unassigned";`
11. A meta-annotation is an annotation that annotates an annotation type.
12. Java's four meta-annotation types are `Target`, `Retention`, `Documented`, and `Inherited`.
13. Generics can be defined as a suite of language features for declaring and using type-agnostic classes and interfaces.
14. You would use generics to ensure that your code is typesafe by avoiding thrown `ClassCastException`s.
15. The difference between a generic type and a parameterized type is that a generic type is a class or interface that introduces a family of parameterized types by declaring a formal type parameter list, and a parameterized type is an instance of a generic type.

16. Anonymous classes cannot be generic because they have no names.
17. The five kinds of actual type arguments are concrete types, concrete parameterized types, array types, type parameters, and wildcards.
18. The answer is true: you cannot specify a primitive-type name (such as `double` or `int`) as an actual type argument.
19. A raw type is a generic type without its type parameters.
20. The compiler reports an unchecked warning message when it detects an explicit cast that involves a type parameter. The compiler is concerned that downcasting to whatever type is passed to the type parameter might result in a violation of type safety.
21. You suppress an unchecked warning message by prefixing the constructor or method that contains the unchecked code with the `@SuppressWarnings("unchecked")` annotation.
22. The answer is true: `List<E>`'s `E` type parameter is unbounded.
23. You specify a single upper bound via reserved word `extends` followed by a type name.
24. A recursive type bound is a type parameter bound that includes the type parameter.
25. Wildcard type arguments are necessary because by accepting any actual type argument they provide a typesafe workaround to the problem of polymorphic behavior not applying to multiple parameterized types that differ only in regard to one type parameter being a subtype of another type parameter. For example, because `List<String>` isn't a kind of `List<Object>`, you cannot pass an object whose type is `List<String>` to a method parameter whose type is `List<Object>`. However, you can pass a `List<String>` object to `List<?>`, provided that you're not going to add the `List<String>` object to the `List<?>`.
26. A generic method is a class or instance method with a type-generalized implementation.
27. Although you might think otherwise, Listing 6–36's `methodCaller()` generic method calls `someOverloadedMethod(Object o)`. This method, instead of `someOverloadedMethod(Date d)`, is called because overload resolution happens at compile time, when the generic method is translated to its unique bytecode representation, and erasure (which takes care of that mapping) causes type parameters to be replaced by their leftmost bound or `Object` (when there is no bound). After erasure, you are left with Listing A-29's nongeneric `methodCaller()` method.

*Listing A-29. The Nongeneric methodCaller() Method That Results from Erasure*

```
public static void methodCaller(Object t)
{
    someOverloadedMethod(t);
}
```

28. Reification is representing the abstract as if it was concrete.
29. The answer is false: type parameters are not reified.
30. Erasure is the throwing away of type parameters following compilation so that they are not available at runtime. Erasure also involves replacing uses of other type variables by the upper bound of the type variable (such as `Object`) and inserting casts to the appropriate type when the resulting code isn't type correct.
31. An enumerated type is a type that specifies a named sequence of related constants as its legal values.
32. Three problems that can arise when you use enumerated types whose constants are `int`-based are lack of compile-time type safety, brittle applications, and the inability to translate `int` constants into meaningful string-based descriptions.
33. An `enum` is an enumerated type that's expressed via reserved word `enum`.
34. You use a `switch` statement with an `enum` by specifying an `enum` constant as the statement's selector expression and constant names as case values.
35. You can enhance an `enum` by adding fields, constructors, and methods; you can even have the `enum` implement interfaces. Also, you can override `toString()` to provide a more useful description of a constant's value and subclass constants to assign different behaviors.
36. The purpose of the abstract `Enum` class is to serve as the common base class of all Java language-based enumeration types.
37. The difference between `Enum`'s `name()` and `toString()` methods is that `name()` always returns a constant's name, but `toString()` can be overridden to return a more meaningful description instead of the constant's name.
38. The answer is true: `Enum`'s generic type is `Enum<E extends Enum<E>>`.
39. Listing A-30 presents a `ToDo` marker annotation type that annotates only type elements and that also uses the default retention policy.



*Listing A-30. The ToDo Annotation Type for Marking Types That Need to Be Completed*

```
import java.lang.annotation.ElementType;
import java.lang.annotation.Target;

@Target(ElementType.TYPE)
public @interface ToDo
{
}
```

40. Listing A-31 presents a rewritten StubFinder application that works with Listing 6–13’s Stub annotation type (with appropriate @Target and @Retention annotations) and Listing 6–14’s Deck class.

*Listing A-31. Reporting a Stub’s ID, Due Date, and Developer via a New Version of StubFinder*

```
import java.lang.reflect.Method;

public class StubFinder
{
    public static void main(String[] args) throws Exception
    {
        if (args.length != 1)
        {
            System.err.println("usage: java StubFinder classfile");
            return;
        }
        Method[] methods = Class.forName(args[0]).getMethods();
        for (int i = 0; i < methods.length; i++)
            if (methods[i].isAnnotationPresent(Stub.class))
            {
                Stub stub = methods[i].getAnnotation(Stub.class);
                System.out.println("Stub ID = " + stub.id());
                System.out.println("Stub Date = " + stub.dueDate());
                System.out.println("Stub Developer = " + stub.developer());
                System.out.println();
            }
    }
}
```

41. Listing A-32 presents the generic Stack class and the StackEmptyException and StackFullException helper classes that were called for in Chapter 6.

*Listing A-32. Stack and Its StackEmptyException and StackFullException Helper Classes Proving That Not All Helper Classes Need to Be Nested*

```
public class Stack<E>
{
    private E[] elements;
    private int top;
```

```
@SuppressWarnings("unchecked")
Stack(int size)
{
    if (size < 2)
        throw new IllegalArgumentException("" + size);
    elements = (E[]) new Object[size];
    top = -1;
}

void push(E element) throws StackFullException
{
    if (top == elements.length - 1)
        throw new StackFullException();
    elements[++top] = element;
}

E pop() throws StackEmptyException
{
    if (isEmpty())
        throw new StackEmptyException();
    return elements[top--];
}

boolean isEmpty()
{
    return top == -1;
}

public static void main(String[] args)
    throws StackFullException, StackEmptyException
{
    Stack<String> stack = new Stack<String>(5);
    assert stack.isEmpty();
    stack.push("A");
    stack.push("B");
    stack.push("C");
    stack.push("D");
    stack.push("E");
    // Uncomment the following line to generate a StackFullException.
    //stack.push("F");
    while (!stack.isEmpty())
        System.out.println(stack.pop());
    // Uncomment the following line to generate a StackEmptyException.
    //stack.pop();
    assert stack.isEmpty();
}
}
```

```
class StackEmptyException extends Exception
{
}
```

```
class StackFullException extends Exception
{
}
```

42. Listing A-33 presents the Compass enum that was called for in Chapter 6.

*Listing A-33. A Compass Enum with Four Direction Constants*

```
enum Compass
{
    NORTH, SOUTH, EAST, WEST
}
```

Listing A-34 presents the UseCompass class that was called for in Chapter 6.

*Listing A-34. Using the Compass Enum to Keep from Getting Lost*

```
public class UseCompass
{
    public static void main(String[] args)
    {
        int i = (int) (Math.random() * 4);
        Compass[] dir = { Compass.NORTH, Compass.EAST, Compass.SOUTH,
                        Compass.WEST };
        switch(dir[i])
        {
            case NORTH: System.out.println("heading north"); break;
            case EAST : System.out.println("heading east"); break;
            case SOUTH: System.out.println("heading south"); break;
            case WEST : System.out.println("heading west"); break;
            default   : assert false; // Should never be reached.
        }
    }
}
```

## Chapter 7: Exploring the Basic APIs, Part 1

1. Math declares double constants E and PI that represent, respectively, the natural logarithm base value (2.71828. . .) and the ratio of a circle's circumference to its diameter (3.14159. . .). E is initialized to 2.718281828459045 and PI is initialized to 3.141592653589793.
2. Math.abs(Integer.MIN\_VALUE) equals Integer.MIN\_VALUE because there doesn't exist a positive 32-bit integer equivalent of MIN\_VALUE. (Integer.MIN\_VALUE equals -2147483648 and Integer.MAX\_VALUE equals 2147483647.)

3. `Math.random()` method returns a pseudorandom number between 0.0 (inclusive) and 1.0 (exclusive). The expression `(int) Math.random() * limit` is incorrect because this expression always returns 0. The `(int)` cast operator has higher precedence than `*`, which means that the cast is performed before multiplication. `random()` returns a fractional value and the cast converts this value to 0, which is then multiplied by `limit`'s value, resulting in an overall value of 0.
4. The five special values that can arise during floating-point calculations are `+infinity`, `-infinity`, `NaN`, `+0.0`, and `-0.0`.
5. `Math` and `StrictMath` differ in the following ways:
  - a. `StrictMath`'s methods return exactly the same results on all platforms. In contrast, some of `Math`'s methods might return values that vary ever so slightly from platform to platform.
  - b. Because `StrictMath` cannot utilize platform-specific features such as an extended-precision math coprocessor, an implementation of `StrictMath` might be less efficient than an implementation of `Math`.
6. The purpose of `strictfp` is to restrict floating-point calculations to ensure portability. This reserved word accomplishes portability in the context of intermediate floating-point representations and overflows/underflows (generating a value too large or small to fit a representation). Furthermore, it can be applied at the method level or at the class level.
7. `BigDecimal` is an immutable class that represents a signed decimal number (such as 23.653) of arbitrary precision with an associated scale. You might use this class to store floating-point values accurately, which represent monetary values and properly round the result of each monetary calculation.
8. The `RoundingMode` constant that describes the form of rounding commonly taught at school is `HALF_UP`.
9. `BigInteger` is an immutable class that represents a signed integer of arbitrary precision. It stores its value in two's complement format.
10. A primitive type wrapper class is a class whose instances wrap themselves around primitive-type values.
11. Java's primitive type wrapper classes are `Boolean`, `Byte`, `Character`, `Double`, `Float`, `Integer`, `Long`, and `Short`.
12. Java provides primitive type wrapper classes to facilitate storing primitive-type values in collections and as a convenient place to associate useful constants and class methods with the primitive-types.
13. The answer is false: `Boolean` is the smallest of the primitive type wrapper classes.

14. You should use `Character` class methods instead of expressions such as `ch >= '0' && ch <= '9'` to determine whether or not a character is a digit, a letter, and so on because it's too easy to introduce a bug into the expression, expressions are not very descriptive of what they're testing, and the expressions are biased toward Latin digits (0–9) and letters (A–Z and a–z).
15. You determine whether or not double variable `d` contains +infinity or -infinity by passing this variable as an argument to `Double`'s boolean `isInfinite(double d)` class method, which returns true when this argument is +infinity or -infinity.
16. `Number` is the superclass of `Byte`, `Character`, and the other primitive type wrapper classes.
17. The answer is true: a string literal is a `String` object.
18. The purpose of `String`'s `intern()` method is to store a unique copy of a `String` object in an internal table of `String` objects. `intern()` makes it possible to compare strings via their references and `==` or `!=`. These operators are the fastest way to compare strings, which is especially valuable when sorting a huge number of strings.
19. `String` and `StringBuffer` differ in that `String` objects contain immutable sequences of characters, whereas `StringBuffer` objects contain mutable sequences of characters.
20. `StringBuffer` and `StringBuilder` differ in that `StringBuffer` methods are synchronized, whereas `StringBuilder`'s equivalent methods are not synchronized. As a result, you would use the thread-safe but slower `StringBuffer` class in multithreaded situations and the nonthread-safe but faster `StringBuilder` class in single-threaded situations.
21. You invoke the `System.arraycopy()` method to copy an array to another array.
22. You invoke the `System.currentTimeMillis()` method to obtain the current time in milliseconds.
23. A thread is an independent path of execution through an application's code.
24. The purpose of the `Runnable` interface is to identify those objects that supply code for threads to execute via this interface's solitary `void run()` method.
25. The purpose of the `Thread` class is to provide a consistent interface to the underlying operating system's threading architecture. It provides methods that make it possible to associate code with threads as well as to start and manage those threads.
26. The answer is false: a `Thread` object associates with a single thread.

27. A race condition is a scenario in which multiple threads are accessing shared data, and the final result of these accesses is dependent on the timing of how the threads are scheduled. Race conditions can lead to bugs that are hard to find and results that are unpredictable.
28. Synchronization is the act of allowing only one thread at a time to execute code within a method or a block.
29. Synchronization is implemented in terms of monitors and locks.
30. Synchronization works by requiring that a thread that wants to enter a monitor-controlled critical section first acquire a lock. The lock is released automatically when the thread exits the critical section.
31. The answer is true: variables of type `long` or `double` are not atomic on 32-bit virtual machines.
32. The purpose of reserved word `volatile` is to let threads running on multiprocessor or multicore machines access the main memory copy of an instance field or class field. Without `volatile`, each thread might access its cached copy of the field and won't see modifications made by other threads to their copies.
33. The answer is false: `Object`'s `wait()` methods cannot be called from outside of a synchronized method or block.
34. Deadlock is a situation where locks are acquired by multiple threads, neither thread holds its own lock but holds the lock needed by some other thread, and neither thread can enter and later exit its critical section to release its held lock because some other thread holds the lock to that critical section.
35. The purpose of the `ThreadLocal` class is to associate per-thread data (such as a user ID) with a thread.
36. `InheritableThreadLocal` differs from `ThreadLocal` in that the former class lets a child thread inherit a thread-local value from its parent thread.
37. Listing A-35 presents the `PrimeNumberTest` application that was called for in Chapter 7.

*Listing A-35. Checking a Positive Integer Argument to Discover If It's Prime*

```
public class PrimeNumberTest
{
    public static void main(String[] args)
    {
        if (args.length != 1)
        {
            System.err.println("usage: java PrimeNumberTest integer");
            System.err.println("integer must be 2 or higher");
            return;
        }
    }
}
```

```

try
{
    int n = Integer.parseInt(args[0]);
    if (n < 2)
    {
        System.err.println(n + " is invalid because it is less than 2");
        return;
    }
    for (int i = 2; i <= Math.sqrt(n); i++)
        if (n % i == 0)
        {
            System.out.println(n + " is not prime");
            return;
        }
    System.out.println(n + " is prime");
}
catch (NumberFormatException nfe)
{
    System.err.println("unable to parse " + args[0] + " into an int");
}
}
}

```

38. Listing A-36 presents the MultiPrint application that was called for in Chapter 7.

*Listing A-36. Printing a Line of Text Multiple Times*

```

public class MultiPrint
{
    public static void main(String[] args)
    {
        if (args.length != 2)
        {
            System.err.println("usage: java MultiPrint text count");
            return;
        }
        String text = args[0];
        int count = Integer.parseInt(args[1]);
        for (int i = 0; i < count; i++)
            System.out.println(text);
    }
}

```

39. The following loop uses StringBuffer to minimize object creation:

```

String[] imageNames = new String[NUM_IMAGES];
StringBuffer sb = new StringBuffer();
for (int i = 0; i < imageNames.length; i++)
{
    sb.append("image");
    sb.append(i);
}

```

```

sb.append(".png");
imageNames[i] = sb.toString();
sb.setLength(0); // Erase previous StringBuffer contents.
}

```

40. Listing A-37 presents the `DigitsToWords` application that was called for in Chapter 7.

*Listing A-37. Converting an Integer Value to Its Textual Representation*

```

public class DigitsToWords
{
    public static void main(String[] args)
    {
        if (args.length != 1)
        {
            System.err.println("usage: java DigitsToWords integer");
            return;
        }
        System.out.println(convertDigitsToWords(Integer.parseInt(args[0]]));
    }

    static String convertDigitsToWords(int integer)
    {
        if (integer < 0 || integer > 9999)
            throw new IllegalArgumentException("Out of range: " + integer);
        if (integer == 0)
            return "zero";
        String[] group1 =
        {
            "one",
            "two",
            "three",
            "four",
            "five",
            "six",
            "seven",
            "eight",
            "nine"
        };
        String[] group2 =
        {
            "ten",
            "eleven",
            "twelve",
            "thirteen",
            "fourteen",
            "fifteen",
            "sixteen",
            "seventeen",

```



```

        "eighteen",
        "nineteen"
    };
    String[] group3 =
    {
        "twenty",
        "thirty",
        "fourty",
        "fifty",
        "sixty",
        "seventy",
        "eighty",
        "ninety"
    };
    StringBuffer result = new StringBuffer();
    if (integer >= 1000)
    {
        int tmp = integer / 1000;
        result.append(group1[tmp - 1] + " thousand");
        integer -= tmp * 1000;
        if (integer == 0)
            return result.toString();
        result.append(" ");
    }
    if (integer >= 100)
    {
        int tmp = integer / 100;
        result.append(group1[tmp - 1] + " hundred");
        integer -= tmp * 100;
        if (integer == 0)
            return result.toString();
        result.append(" and ");
    }
    if (integer >= 10 && integer <= 19)
    {
        result.append(group2[integer - 10]);
        return result.toString();
    }
    if (integer >= 20)
    {
        int tmp = integer / 10;
        result.append(group3[tmp - 2]);
        integer -= tmp * 10;
        if (integer == 0)
            return result.toString();
        result.append("-");
    }
    result.append(group1[integer - 1]);
    return result.toString();
}
}

```

41. Listing A-38 presents the EVDump application that was called for in Chapter 7.

*Listing A-38. Dumping All Environment Variables to Standard Output*

```
public class EVDump
{
    public static void main(String[] args)
    {
        System.out.println(System.getenv()); // System.out.println() calls toString()
                                             // on its object argument and outputs this
                                             // string
    }
}
```

42. Listing A-39 presents the revised CountingThreads application that was called for in Chapter 7.

*Listing A-39. Counting via Daemon Threads*

```
public class CountingThreads
{
    public static void main(String[] args)
    {
        Runnable r = new Runnable()
        {
            @Override
            public void run()
            {
                String name = Thread.currentThread().getName();
                int count = 0;
                while (true)
                    System.out.println(name + ": " + count++);
            }
        };
        Thread thdA = new Thread(r);
        thdA.setDaemon(true);
        Thread thdB = new Thread(r);
        thdB.setDaemon(true);
        thdA.start();
        thdB.start();
    }
}
```

When you run this application, the two daemon threads start executing, and you will probably see some output. However, the application will end as soon as the default main thread leaves the `main()` method and dies.

43. Listing A-40 presents the StopCountingThreads application that was called for in Chapter 7.

*Listing A-40. Stopping the Counting Threads When Return/Enter is Pressed*

```

import java.io.IOException;

public class StopCountingThreads
{
    private static volatile boolean stopped = false;

    public static void main(String[] args)
    {
        Runnable r = new Runnable()
        {
            @Override
            public void run()
            {
                String name = Thread.currentThread().getName();
                int count = 0;
                while (!stopped)
                    System.out.println(name + ": " + count++);
            }
        };
        Thread thdA = new Thread(r);
        Thread thdB = new Thread(r);
        thdA.start();
        thdB.start();
        try { System.in.read(); } catch (IOException ioe) {}
        stopped = true;
    }
}

```

## Chapter 8: Exploring the Basic APIs, Part 2

1. Instances of the `Random` class generate sequences of random numbers by starting with a special 48-bit value that's known as a seed. This value is subsequently modified by a mathematical algorithm, which is known as a linear congruential generator.
2. The root set of references is a collection of local variables, parameters, class fields, and instance fields that currently exist and that contain (possibly null) references to objects.
3. The answer is false: the garbage collector can collect unreachable objects only.
4. The different levels of reachability are strongly reachable, softly reachable, weakly reachable, and phantom reachable.
5. The difference between a soft reference and a weak reference is that the garbage collector is more eager to collect an object that is reachable only via a weak reference.

6. The classes that comprise the References API are `Reference`, `ReferenceQueue`, `SoftReference`, `WeakReference`, and `PhantomReference`. All of these classes are located in the `java.lang.ref` package.
7. You would use the `SoftReference` class to implement caches of objects that are expensive timewise to create.
8. You would use the `PhantomReference` class as a replacement for the `finalize()` method.
9. Some of the capabilities offered by the Reflection API are letting applications dynamically load and learn about loaded classes and other reference types; and letting applications instantiate classes, call methods, access fields, and perform other tasks reflectively.
10. Reflection shouldn't be used indiscriminately for several reasons. Application performance suffers because it takes longer to perform operations with reflection than without reflection. Also, reflection-oriented code can be harder to read, and the absence of compile-time type checking can result in runtime failures.
11. The class that's the entry point into the Reflection API is `java.lang.Class`.
12. The answer is false: not all of the Reflection API is contained in the `java.lang.reflect` package. For example, `Class` is located in the `java.lang` package.
13. The three ways to obtain a `Class` object are to invoke `Class`'s `forName()` method, to invoke `Object`'s `getClass()` method, and to use a class literal.
14. The answer is true: you can use class literals with primitive-types.
15. You instantiate a dynamically loaded class by invoking `Class`'s `newInstance()` method.
16. You invoke `Constructor`'s `Class[]<?> getParameterTypes()` method to obtain a constructor's parameter types.
17. `Class`'s `Field getField(String name)` method throws `NoSuchFieldException` when it cannot locate the named field.
18. You determine if a method is declared to receive a variable number of arguments by invoking `Method`'s `isVarArgs()` method on the `Method` object that represents the method.
19. The answer is true: you can reflectively make a private method accessible. You do this by invoking the `setAccessible()` method that each of `Constructor`, `Field`, and `Method` inherits from its `AccessibleObject` superclass.

20. The purpose of `Package`'s `isSealed()` method is to indicate whether or not a package is sealed (all classes that are part of the package are archived in the same JAR file). This method returns `true` when the package is sealed.
21. The answer is `true`: `getPackage()` requires at least one classfile to be loaded from the package before it returns a `Package` object describing that package.
22. You reflectively create and access a Java array by invoking the class methods declared in the `java.lang.reflect.Array` class.
23. The purpose of the `StringTokenizer` class is to provide access to a string's individual components.
24. The `java.util` package's `Timer` and `TimerTask` classes are the standard class library's convenient and simpler alternative to the `Threads` API for scheduling task execution.
25. The answer is `false`: `Timer()` creates a new timer whose task-execution thread doesn't run as a daemon thread.
26. In fixed-delay execution, each execution is scheduled relative to the actual execution time of the previous execution. When an execution is delayed for any reason (such as garbage collection), subsequent executions are also delayed.
27. You call the `schedule()` methods to schedule a task for fixed-delay execution.
28. In fixed-rate execution, each execution is scheduled relative to the scheduled execution time of the initial execution. When an execution is delayed for any reason (such as garbage collection), two or more executions will occur in rapid succession to "catch up."
29. The difference between `Timer`'s `cancel()` method and `TimerTask`'s `cancel()` method is as follows: `Timer`'s `cancel()` method terminates the timer, discarding any currently scheduled timer tasks. In contrast, `TimerTask`'s `cancel()` method cancels the invoking timer task only.
30. Listing A-41 presents the `Guess` application that was called for in Chapter 8.

*Listing A-41. Guessing Game*

```
import java.util.Random;

public class Guess
{
    public static void main(String[] args) throws java.io.IOException
    {
        Random r = new Random();
        int hiddenValue = 'a' + r.nextInt(26);

        while (true)
```

```

{
    int guess = 0;
    while (guess < 'a' || guess > 'z')
    {
        System.out.print("Guess between a and z inclusive: ");
        guess = System.in.read();
        System.out.println();

        // Flush carriage return or carriage return/newline combination
        // so that each character isn't automatically read during the
        // next System.in.read() method call.

        int x = 0;
        while (x != '\n')
            x = System.in.read();
    }
    if (guess < hiddenValue)
        System.out.println("too low");
    else
    if (guess > hiddenValue)
        System.out.println("too high");
    else
    {
        System.out.println("you got it");
        break;
    }
}
}
}

```

31. Listing A-42 presents the Classify application that was called for in Chapter 8.

*Listing A-42. Classifying a Command-Line Argument as an Annotation Type, Enum, Interface, or Class*

```

public class Classify
{
    public static void main(String[] args)
    {
        if (args.length != 1)
        {
            System.err.println("usage: java Classify pkgAndTypeName");
            return;
        }

        try
        {
            Class<?> clazz = Class.forName(args[0]);
            if (clazz.isAnnotation())
                System.out.println("Annotation");
            else
            if (clazz.isEnum())
                System.out.println("Enum");
        }
    }
}

```

```

        else
        if (clazz.isInterface())
            System.out.println("Interface");
        else
            System.out.println("Class");
    }
    catch (ClassNotFoundException cnfe)
    {
        System.err.println("could not locate " + args[0]);
    }
}
}

```

Specify `java Classify java.lang.Override`, and you'll see `Annotation` as the output. Also, `java Classify java.math.RoundingMode` outputs `Enum`, `java Classify java.lang.Runnable` outputs `Interface`, and `java Classify java.lang.Class` outputs `Class`.

32. Listing A-43 presents the `Tokenize` application that was called for in Chapter 8.

*Listing A-43. Extracting the Month, Day, Year, Hour, Minute, and Second Tokens from a Date String*

```

import java.util.StringTokenizer;

public class Tokenize
{
    public static void main(String[] args)
    {
        String date = "03-12-2014 03:05:20";
        StringTokenizer st = new StringTokenizer(date, "- :");
        System.out.println("Month = " + st.nextToken());
        System.out.println("Day = " + st.nextToken());
        System.out.println("Year = " + st.nextToken());
        System.out.println("Hour = " + st.nextToken());
        System.out.println("Minute = " + st.nextToken());
        System.out.println("Second = " + st.nextToken());
    }
}

```

33. Listing A-44 presents the `BackAndForth` application that was called for in Chapter 8.

*Listing A-44. Repeatedly Moving an Asterisk Back and Forth via a Timer*

```

import java.util.Timer;
import java.util.TimerTask;

public class BackAndForth
{
    static enum Direction { FORWARDS, BACKWARDS }

    public static void main(String[] args)
    {

```

```

TimerTask task = new TimerTask()
    {
        final static int MAXSTEPS = 20;

        Direction direction = Direction.FORWARDS;

        int steps = 0;

        @Override
        public void run()
        {
            switch (direction)
            {
                case FORWARDS : System.out.print("\b ");
                               System.out.print("*");
                               break;

                case BACKWARDS: System.out.print("\b ");
                               System.out.print("\b\b*");
            }

            if (++steps == MAXSTEPS)
            {
                direction = (direction == Direction.FORWARDS)
                    ? Direction.BACKWARDS
                    : Direction.FORWARDS;

                steps = 0;
            }
        }
    };
Timer timer = new Timer();
timer.schedule(task, 0, 100);
}

```

## Chapter 9: Exploring the Collections Framework

1. A collection is a group of objects that are stored in an instance of a class designed for this purpose.
2. The Collections Framework is a group of types that offers a standard architecture for representing and manipulating collections.
3. The Collections Framework largely consists of core interfaces, implementation classes, and utility classes.
4. A comparable is an object whose class implements the Comparable interface.
5. You would have a class implement the Comparable interface when you want objects to be compared according to their natural ordering.



6. A comparator is an object whose class implements the `Comparator` interface. Its purpose is to allow objects to be compared according to an order that's different from their natural ordering.
7. The answer is false: a collection uses a comparable (an object whose class implements the `Comparable` interface) to define the natural ordering of its elements.
8. The `Iterable` interface describes any object that can return its contained objects in some sequence.
9. The `Collection` interface represents a collection of objects that are known as elements.
10. A situation where `Collection`'s `add()` method would throw an instance of the `UnsupportedOperationException` class is an attempt to add an element to an unmodifiable collection.
11. `Iterable`'s `iterator()` method returns an instance of a class that implements the `Iterator` interface. This interface provides a `hasNext()` method to determine if the end of the iteration over the collection has been reached, a `next()` method to return a collection's next element, and a `remove()` method to remove the last element returned by `next()` from the collection.
12. The purpose of the enhanced for loop statement is to simplify collection or array iteration.
13. The enhanced for loop statement is expressed as `for (typeid: collection)` or `for (typeid: array)` and reads "for each *type* object in *collection*, assign this object to *id* at the start of the loop iteration" or "for each *type* object in *array*, assign this object to *id* at the start of the loop iteration."
14. The answer is true: the enhanced for loop works with arrays. For example, `int[] x = { 1, 2, 3 }; for (int i: x) System.out.println(i);` declares array `x` and outputs all of its `int`-based elements.
15. Autoboxing is the act of wrapping a primitive-type value in an object of a primitive type wrapper class whenever a primitive-type is specified but a reference is required. This feature saves the developer from having to instantiate a wrapper class explicitly when storing the primitive-type value in a collection.
16. Unboxing is the act of unwrapping a primitive-type value from its wrapper object whenever a reference is specified but a primitive-type is required. This feature saves the developer from having to call a method explicitly on the object (such as `intValue()`) to retrieve the wrapped value.
17. A list is an ordered collection, which is also known as a sequence. Elements can be stored in and accessed from specific locations via integer indexes.

18. A `ListIterator` instance uses a cursor to navigate through a list.
19. A view is a list that's backed by another list. Changes that are made to the view are reflected in this backing list.
20. You would use the `subList()` method to perform range-view operations over a collection in a compact manner. For example, `list.subList(fromIndex, toIndex).clear();` removes a range of elements from `list`, where the first element is located at `fromIndex` and the last element is located at `toIndex - 1`.
21. The `ArrayList` class provides a list implementation that's based on an internal array.
22. The `LinkedList` class provides a list implementation that's based on linked nodes.
23. A node is a fixed sequence of value and link memory locations (that is, an arrangement of a specific number of values and links, such as one value location followed by one link location). From an object-oriented perspective, it's an object whose fields store values and references to other node objects. These references are also known as links.
24. The answer is false: `ArrayList` provides slower element insertions and deletions than `LinkedList`.
25. A set is a collection that contains no duplicate elements.
26. The `TreeSet` class provides a set implementation that's based on a tree data structure. As a result, elements are stored in sorted order.
27. The `HashSet` class provides a set implementation that's backed by a hashtable data structure.
28. The answer is true: to avoid duplicate elements in a hashset, your own classes must correctly override `equals()` and `hashCode()`.
29. The difference between `HashSet` and `LinkedHashSet` is that `LinkedHashSet` uses a linked list to store its elements, resulting in its iterator returning elements in the order in which they were inserted.
30. The `EnumSet` class provides a `Set` implementation that's based on a bitset.
31. A sorted set is a set that maintains its elements in ascending order, sorted according to their natural ordering or according to a comparator that's supplied when the sorted set is created. Furthermore, the set's implementation class must implement the `SortedSet` interface.
32. A navigable set is a sorted set that can be iterated over in descending order as well as ascending order and which can report closest matches for given search targets.

33. The answer is false: `HashSet` isn't an example of a sorted set. However, `TreeSet` is an example of a sorted set.
34. A sorted set's `add()` method would throw `ClassCastException` when you attempt to add an element to the sorted set because the element's class doesn't implement `Comparable`.
35. A queue is a collection in which elements are stored and retrieved in a specific order. Most queues are categorized as "first-in, first out," "last-in, first-out," or priority.
36. The answer is true: `Queue`'s `element()` method throws `NoSuchElementException` when it's called on an empty queue.
37. The `PriorityQueue` class provides an implementation of a priority queue, which is a queue that orders its elements according to their natural ordering or by a comparator provided when the queue is instantiated.
38. A map is a group of key/value pairs (also known as entries).
39. The `TreeMap` class provides a map implementation that's based on a red-black tree. As a result, entries are stored in sorted order of their keys.
40. The `HashMap` class provides a map implementation that's based on a hashtable data structure.
41. A hashtable uses a hash function to map keys to integer values.
42. Continuing from the previous exercise, the resulting integer values are known as hash codes. They identify hashtable array elements, which are known as buckets or slots.
43. A hashtable's capacity refers to the number of buckets.
44. A hashtable's load factor refers to the ratio of the number of stored entries divided by the number of buckets.
45. The difference between `HashMap` and `LinkedHashMap` is that `LinkedHashMap` uses a linked list to store its entries, resulting in its iterator returning entries in the order in which they were inserted.
46. The `IdentityHashMap` class provides a `Map` implementation that uses reference equality (`==`) instead of object equality (`equals()`) when comparing keys and values.
47. The `EnumMap` class provides a `Map` implementation whose keys are the members of the same enum.
48. A sorted map is a map that maintains its entries in ascending order, sorted according to the keys' natural ordering or according to a comparator that's supplied when the sorted map is created. Furthermore, the map's implementation class must implement the `SortedMap` interface.

49. A navigable map is a sorted map that can be iterated over in descending order as well as ascending order and which can report closest matches for given search targets.
50. The answer is true: `TreeMap` is an example of a sorted map.
51. The purpose of the `Arrays` class's static `<T> List<T> asList(T... array)` method is to return a fixed-size list backed by the specified array. (Changes to the returned list "write through" to the array.)
52. The answer is false: binary search is faster than linear search.
53. You would use `Collections`' static `<T> Set<T> synchronizedSet(Set<T> s)` method to return a synchronized variation of a hashset.
54. The seven legacy collections-oriented types are `Vector`, `Enumeration`, `Stack`, `Dictionary`, `Hashtable`, `Properties`, and `BitSet`.
55. Listing A-45 presents the `JavaQuiz` application that was called for in Chapter 9.

*Listing A-45. How Much Do You Know About Java? Take the Quiz and Find Out!*

```
import java.util.ArrayList;
import java.util.Iterator;
import java.util.List;

public class JavaQuiz
{
    private static class QuizEntry
    {
        private String question;
        private String[] choices;
        private char answer;

        QuizEntry(String question, String[] choices, char answer)
        {
            this.question = question;
            this.choices = choices;
            this.answer = answer;
        }

        String[] getChoices()
        {
            // Demonstrate returning a copy of the choices array to prevent clients
            // from directly manipulating (and possibly screwing up) the internal
            // choices array.
            String[] temp = new String[choices.length];
            System.arraycopy(choices, 0, temp, 0, choices.length);
            return temp;
        }
    }
}
```

```
String getQuestion()
{
    return question;
}

char getAnswer()
{
    return answer;
}
}

static QuizEntry[] quizEntries =
{
    new QuizEntry("What was Java's original name?",
        new String[] { "Oak", "Duke", "J", "None of the above" },
        'A'),
    new QuizEntry("Which of the following reserved words is also a literal?",
        new String[] { "for", "long", "true", "enum" },
        'C'),
    new QuizEntry("The conditional operator (?:) resembles which statement?",
        new String[] { "switch", "if-else", "if", "while" },
        'B')
};

public static void main(String[] args)
{
    // Populate the quiz list.
    List<QuizEntry> quiz = new ArrayList<QuizEntry>();
    for (QuizEntry entry: quizEntries)
        quiz.add(entry);
    // Perform the quiz.
    System.out.println("Java Quiz");
    System.out.println("-----\n");
    Iterator<QuizEntry> iter = quiz.iterator();
    while (iter.hasNext())
    {
        QuizEntry qe = iter.next();
        System.out.println(qe.getQuestion());
        String[] choices = qe.getChoices();
        for (int i = 0; i < choices.length; i++)
            System.out.println("  " + (char) ('A' + i) + ": " + choices[i]);
        int choice = -1;
        while (choice < 'A' || choice > 'A' + choices.length)
        {
            System.out.print("Enter choice letter: ");
            try
            {
                choice = System.in.read();
                // Remove trailing characters up to and including the newline
                // to avoid having these characters automatically returned in
                // subsequent System.in.read() method calls.
                while (System.in.read() != '\n');
```

```

        choice = Character.toUpperCase((char) choice);
    }
    catch (java.io.IOException ioe)
    {
    }
}
if (choice == qe.getAnswer())
    System.out.println("You are correct!\n");
else
    System.out.println("You are not correct!\n");
}
}
}

```

56. `(int) (f ^ (f >>> 32))` is used instead of `(int) (f ^ (f >> 32))` in the hash code generation algorithm because `>>>` always shifts a 0 to the right, which doesn't affect the hash code, whereas `>>` shifts a 0 or a 1 to the right (whatever value is in the sign bit), which affects the hash code when a 1 is shifted.
57. Listing A-46 presents the `FrequencyDemo` application that was called for in Chapter 9.

*Listing A-46. Reporting the Frequency of Last Command-Line Argument Occurrences in the Previous Command-Line Arguments*

```

import java.util.Collections;
import java.util.LinkedList;
import java.util.List;

public class FrequencyDemo
{
    public static void main(String[] args)
    {
        List<String> listOfArgs = new LinkedList<String>();
        String lastArg = (args.length == 0) ? null : args[args.length - 1];
        for (int i = 0; i < args.length - 1; i++)
            listOfArgs.add(args[i]);
        System.out.println("Number of occurrences of " + lastArg + " = " +
            Collections.frequency(listOfArgs, lastArg));
    }
}

```

## Chapter 10: Exploring the Concurrency Utilities

1. Concurrency Utilities is a framework of classes and interfaces that overcome problems with the `Threads` API. Specifically, low-level concurrency primitives such as `synchronized` and `wait()/notify()` are often hard to use correctly; too much reliance on the `synchronized` primitive can lead to performance issues, which affect an application's scalability; and higher-level constructs such as thread pools and semaphores aren't included with Java's low-level threading capabilities.

2. The packages in which Concurrency Utilities types are stored are `java.util.concurrent`, `java.util.concurrent.atomic`, and `java.util.concurrent.locks`.
3. A task is an object whose class implements the `Runnable` interface (a runnable task) or the `Callable` interface (a callable task).
4. An executor is an object whose class directly or indirectly implements the `Executor` interface, which decouples task submission from task-execution mechanics.
5. The `Executor` interface focuses exclusively on `Runnable`, which means that there's no convenient way for a runnable task to return a value to its caller (because `Runnable`'s `run()` method doesn't return a value); `Executor` doesn't provide a way to track the progress of executing runnable tasks, cancel an executing runnable task, or determine when the runnable task finishes execution; `Executor` cannot execute a collection of runnable tasks; and `Executor` doesn't provide a way for an application to shut down an executor (much less to shut down an executor properly).
6. `Executor`'s limitations are overcome by providing the `ExecutorService` interface.
7. The differences existing between `Runnable`'s `run()` method and `Callable`'s `call()` method are as follows: `run()` cannot return a value, whereas `call()` can return a value; and `run()` cannot throw checked exceptions, whereas `call()` can throw checked exceptions.
8. The answer is false: you can throw checked and unchecked exceptions from `Callable`'s `call()` method but can only throw unchecked exceptions from `Runnable`'s `run()` method.
9. A future is an object whose class implements the `Future` interface. It represents an asynchronous computation and provides methods for canceling a task, for returning a task's value, and for determining whether or not the task has finished.
10. The `Executors` class's `newFixedThreadPool()` method creates a thread pool that reuses a fixed number of threads operating off of a shared unbounded queue. At most, `nThreads` threads are actively processing tasks. If additional tasks are submitted when all threads are active, they wait in the queue for an available thread. If any thread terminates because of a failure during execution before the executor shuts down, a new thread will take its place when needed to execute subsequent tasks. The threads in the pool will exist until the executor is explicitly shut down.
11. A synchronizer is a class that facilitates a common form of synchronization.

12. Four commonly used synchronizers are countdown latches, cyclic barriers, exchangers, and semaphores. A countdown latch lets one or more threads wait at a “gate” until another thread opens this gate, at which point these other threads can continue. A cyclic barrier lets a group of threads wait for each other to reach a common barrier point. An exchanger lets a pair of threads exchange objects at a synchronization point. A semaphore maintains a set of permits for restricting the number of threads that can access a limited resource.
13. The concurrency-oriented extensions to the Collections Framework provided by the Concurrency Utilities are `ArrayBlockingQueue`, `BlockingDeque`, `BlockingQueue`, `ConcurrentHashMap`, `ConcurrentMap`, `ConcurrentNavigableMap`, `ConcurrentLinkedQueue`, `ConcurrentSkipListMap`, `ConcurrentSkipListSet`, `CopyOnWriteArrayList`, `CopyOnWriteArraySet`, `DelayQueue`, `LinkedBlockingDeque`, `LinkedBlockingQueue`, `PriorityBlockingQueue`, and `SynchronousQueue`.
14. A lock is an instance of a class that implements the `Lock` interface, which provides more extensive locking operations than can be achieved via the `synchronized` reserved word. `Lock` also supports a wait/notification mechanism through associated `Condition` objects.
15. The biggest advantage that `Lock` objects hold over the implicit locks that are obtained when threads enter critical sections (controlled via the `synchronized` reserved word) is their ability to back out of an attempt to acquire a lock.
16. You obtain a `Condition` instance for use with a particular `Lock` instance by invoking `Lock`’s `Condition newCondition()` method.
17. An atomic variable is an instance of a class that encapsulates a single variable and supports lock-free, thread-safe operations on that variable, for example, `AtomicInteger`.
18. The `AtomicIntegerArray` class describes an `int` array whose elements may be updated atomically.
19. The answer is false: `volatile` doesn’t support atomic read-modify-write sequences.
20. The Compare-and-Swap instruction is responsible for the performance gains offered by the Concurrency Utilities.
21. Listing A-47 presents the `CountingThreads` application that was called for in Chapter 10.



*Listing A-47. Executor-Based Counting Threads*

```

import java.util.concurrent.Executors;
import java.util.concurrent.ExecutorService;

public class CountingThreads
{
    public static void main(String[] args)
    {
        Runnable r = new Runnable()
        {
            @Override
            public void run()
            {
                String name = Thread.currentThread().getName();
                int count = 0;
                while (true)
                    System.out.println(name + ": " + count++);
            }
        };
        ExecutorService es = Executors.newFixedThreadPool(2);
        es.submit(r);
        es.submit(r);
    }
}

```

22. Listing A-48 presents the CountingThreads application with custom-named threads that was called for in Chapter 10.

*Listing A-48. Executor-Based Counting Threads A and B*

```

import java.util.concurrent.Executors;
import java.util.concurrent.ExecutorService;
import java.util.concurrent.ThreadFactory;

public class CountingThreads
{
    public static void main(String[] args)
    {
        Runnable r = new Runnable()
        {
            @Override
            public void run()
            {
                String name = Thread.currentThread().getName();
                int count = 0;
                while (true)
                    System.out.println(name + ": " + count++);
            }
        };
        ExecutorService es =
            Executors.newSingleThreadExecutor(new NamedThread("A"));
    }
}

```

```

        es.submit(r);
        es = Executors.newSingleThreadExecutor(new NamedThread("B"));
        es.submit(r);
    }
}

class NamedThread implements ThreadFactory
{
    private String name;

    NamedThread(String name)
    {
        this.name = name;
    }

    @Override
    public Thread newThread(Runnable r)
    {
        return new Thread(r, name);
    }
}

```

23. Listing A-49 presents the `DeadlockDemo` application that was called for in Chapter 10.

*Listing A-49. Demonstrating Deadlock via Lock and ReentrantLock*

```

import java.util.concurrent.Executors;
import java.util.concurrent.ExecutorService;

import java.util.concurrent.locks.Lock;
import java.util.concurrent.locks.ReentrantLock;

public class DeadlockDemo
{
    private final Lock lock1 = new ReentrantLock();
    private final Lock lock2 = new ReentrantLock();

    public void m1()
    {
        lock1.lock();
        try
        {
            lock2.lock();
            try
            {
                System.out.println("first thread in m1()");
            }
            finally
            {
                lock2.unlock();
            }
        }
    }
}

```

```
        finally
        {
            lock1.unlock();
        }
    }

    public void m2()
    {
        lock2.lock();
        try
        {
            lock1.lock();
            try
            {
                System.out.println("second thread in m2()");
            }
            finally
            {
                lock1.unlock();
            }
        }
        finally
        {
            lock2.unlock();
        }
    }

    public static void main(String[] args)
    {
        final DeadlockDemo dld = new DeadlockDemo();
        Runnable runnable1 = new Runnable()
        {
            @Override
            public void run()
            {
                while(true)
                {
                    dld.m1();
                    try
                    {
                        Thread.sleep(50);
                    }
                    catch (InterruptedException ie)
                    {
                        assert false;
                    }
                }
            }
        };
    }
};
```

```

ExecutorService executor1 = Executors.newSingleThreadExecutor();
Runnable runnable2 = new Runnable()
    {
        @Override
        public void run()
        {
            while(true)
            {
                dld.m2();
                try
                {
                    Thread.sleep(50);
                }
                catch (InterruptedException ie)
                {
                    assert false;
                }
            }
        }
    };
ExecutorService executor2 = Executors.newSingleThreadExecutor();
executor1.submit(runnable1);
executor2.submit(runnable2);
}
}

```

Listing A-50 presents the DeadlockDemo application that avoids deadlock that was called for in Chapter 10.

**Listing A-50. Demonstrating Deadlock Avoidance via Lock and ReentrantLock**

```

import java.util.concurrent.Executors;
import java.util.concurrent.ExecutorService;

import java.util.concurrent.locks.Lock;
import java.util.concurrent.locks.ReentrantLock;

public class DeadlockDemo
{
    private final Lock lock1 = new ReentrantLock();
    private final Lock lock2 = new ReentrantLock();

    public void m1()
    {
        if (lock1.tryLock())
            try
            {
                if (lock2.tryLock())
                    try
                    {
                        System.out.println("first thread in m1()");
                    }
            }
    }
}

```

```
        finally
        {
            lock2.unlock();
        }
    }
    finally
    {
        lock1.unlock();
    }
}

public void m2()
{
    if (lock2.tryLock())
        try
        {
            if (lock1.tryLock())
                try
                {
                    System.out.println("second thread in m2()");
                }
                finally
                {
                    lock1.unlock();
                }
            }
        }
        finally
        {
            lock2.unlock();
        }
}

public static void main(String[] args)
{
    final DeadlockDemo dld = new DeadlockDemo();
    Runnable runnable1 = new Runnable()
    {
        @Override
        public void run()
        {
            while(true)
            {
                dld.m1();
                try
                {
                    Thread.sleep(50);
                }
                catch (InterruptedException ie)
                {
                    assert false;
                }
            }
        }
    };
};
```

```

ExecutorService executor1 = Executors.newSingleThreadExecutor();
Runnable runnable2 = new Runnable()
    {
        @Override
        public void run()
        {
            while(true)
            {
                dld.m2();
                try
                {
                    Thread.sleep(50);
                }
                catch (InterruptedException ie)
                {
                    assert false;
                }
            }
        }
    };
ExecutorService executor2 = Executors.newSingleThreadExecutor();
executor1.submit(runnable1);
executor2.submit(runnable2);
}
}

```

24. The atomic variable equivalent of `int total = ++counter;` is as follows:

```

AtomicInteger counter = new AtomicInteger(0);
int total = counter.incrementAndGet();

```

The atomic variable equivalent of `int total = counter--;` is as follows:

```

AtomicInteger counter = new AtomicInteger(0);
int total = counter.getAndDecrement();

```

## Chapter 11: Performing Classic I/O

1. The purpose of the `File` class is to offer access to the underlying platform's available filesystem(s).
2. Instances of the `File` class contain the pathnames of files and directories that may or may not exist in their filesystems.
3. `File`'s `listRoots()` method returns an array of `File` objects denoting the root directories (roots) of available filesystems.
4. A path is a hierarchy of directories that must be traversed to locate a file or a directory. A pathname is a string representation of a path; a platform-dependent separator character (such as the Windows backslash [`\`] character) appears between consecutive names.

5. The difference between an absolute pathname and a relative pathname is as follows: an absolute pathname is a pathname that starts with the root directory symbol, whereas a relative pathname is a pathname that doesn't start with the root directory symbol (it's interpreted via information taken from some other pathname).
6. You obtain the current user (also known as working) directory by specifying `System.getProperty("user.dir")`.
7. A parent pathname is a string that consists of all pathname components except for the last name.
8. Normalize means to replace separator characters with the default name-separator character so that the pathname is compliant with the underlying filesystem.
9. You obtain the default name-separator character by accessing `File`'s `separator` and `separatorChar` class fields. The first field stores the character as a `char` and the second field stores it as a `String`.
10. A canonical pathname is a pathname that's absolute and unique, and it is formatted the same way every time.
11. The difference between `File`'s `getParent()` and `getName()` methods is that `getParent()` returns the parent pathname and `getName()` returns the last name in the pathname's name sequence.
12. The answer is false: `File`'s `exists()` method determines whether or not a file or directory exists.
13. A normal file is a file that's not a directory and that satisfies other platform-dependent criteria: it's not a symbolic link or named pipe, for example. Any nondirectory file created by a Java application is guaranteed to be a normal file.
14. `File`'s `lastModified()` method returns the time that the file denoted by this `File` object's pathname was last modified or 0 when the file doesn't exist or an I/O error occurred during this method call. The returned value is measured in milliseconds since the Unix epoch (00:00:00 GMT, January 1, 1970).
15. The answer is true: `File`'s `list()` method returns an array of `Strings` where each entry is a filename rather than a complete path.
16. The difference between the `FilenameFilter` and `FileFilter` interfaces is as follows: `FilenameFilter` declares a single `boolean accept(File dir, String name)` method, whereas `FileFilter` declares a single `boolean accept(String pathname)` method. Either method accomplishes the same task of accepting (by returning true) or rejecting (by returning false) the inclusion of the file or directory identified by the argument(s) in a directory listing.

17. The answer is false: `File`'s `createNewFile()` method checks for file existence and creates the file when it doesn't exist in a single operation that's atomic with respect to all other filesystem activities that might affect the file.
18. The default temporary directory where `File`'s `createTempFile(String, String)` method creates temporary files can be located by reading the `java.io.tmpdir` system property.
19. You ensure that a temporary file is removed when the virtual machine ends normally (it doesn't crash and the power isn't lost) by registering the temporary file for deletion through a call to `File`'s `deleteOnExit()` method.
20. You would accurately compare two `File` objects by first calling `File`'s `getCanonicalFile()` method on each `File` object and then comparing the returned `File` objects.
21. The purpose of the `RandomAccessFile` class is to create and/or open files for random access in which a mixture of write and read operations can occur until the file is closed.
22. The purpose of the "rwd" and "rws" mode arguments is to ensure that any writes to a file located on a local storage device are written to the device, which guarantees that critical data isn't lost when the system crashes. No guarantee is made when the file doesn't reside on a local device.
23. A file pointer is a cursor that identifies the location of the next byte to write or read. When an existing file is opened, the file pointer is set to its first byte at offset 0. The file pointer is also set to 0 when the file is created.
24. The answer is false: when you call `RandomAccessFile`'s `seek(long)` method to set the file pointer's value, and when this value is greater than the length of the file, the file's length doesn't change. The file length will only change by writing after the offset has been set beyond the end of the file.
25. A flat file database is a single file organized into records and fields. A record stores a single entry (such as a part in a parts database) and a field stores a single attribute of the entry (such as a part number).
26. A stream is an ordered sequence of bytes of arbitrary length. Bytes flow over an output stream from an application to a destination, and flow over an input stream from a source to an application.
27. The purpose of `OutputStream`'s `flush()` method is to write any buffered output bytes to the destination. If the intended destination of this output stream is an abstraction provided by the underlying platform (such as a file), flushing the stream only guarantees that bytes previously written to the stream are passed to the underlying platform for writing; it doesn't guarantee that they're actually written to a physical device such as a disk drive.



28. The answer is true: `OutputStream`'s `close()` method automatically flushes the output stream. If an application ends before `close()` is called, the output stream is automatically closed and its data is flushed.
29. The purpose of `InputStream`'s `mark(int)` and `reset()` methods is to reread a portion of a stream. `mark(int)` marks the current position in this input stream. A subsequent call to `reset()` repositions this stream to the last marked position so that subsequent read operations reread the same bytes. Don't forget to call `markSupported()` to find out if the subclass supports `mark()` and `reset()`.
30. You would access a copy of a `ByteArrayOutputStream` instance's internal byte array by calling `ByteArrayOutputStream`'s `toByteArray()` method.
31. The answer is false: `FileOutputStream` and `FileInputStream` don't provide internal buffers to improve the performance of write and read operations.
32. You would use `PipedOutputStream` and `PipedInputStream` to communicate data between a pair of executing threads.
33. A filter stream is a stream that buffers, compresses/uncompresses, encrypts/decrypts, or otherwise manipulates an input stream's byte sequence before it reaches its destination.
34. Two streams are chained together when a stream instance is passed to another stream class's constructor.
35. You improve the performance of a file output stream by chaining a `BufferedOutputStream` instance to a `FileOutputStream` instance and calling the `BufferedOutputStream` instance's `write()` methods so that data is buffered before flowing to the file output stream. You improve the performance of a file input stream by chaining a `BufferedInputStream` instance to a `FileInputStream` instance so that data flowing from a file input stream is buffered before being returned from the `BufferedInputStream` instance by calling this instance's `read()` methods.
36. `DataOutputStream` and `DataInputStream` support `FileOutputStream` and `FileInputStream` by providing methods to write and read primitive-type values and strings in a platform-independent way. In contrast, `FileOutputStream` and `FileInputStream` provide methods for writing/reading bytes and arrays of bytes only.
37. Object serialization is a virtual machine mechanism for serializing object state into a stream of bytes. Its deserialization counterpart is a virtual machine mechanism for deserializing this state from a byte stream.
38. The three forms of serialization and deserialization that Java supports are default serialization and deserialization, custom serialization and deserialization, and externalization.

39. The purpose of the `Serializable` interface is to tell the virtual machine that it's okay to serialize objects of the implementing class.
40. When the serialization mechanism encounters an object whose class doesn't implement `Serializable`, it throws an instance of the `NotSerializableException` class.
41. The three stated reasons for Java not supporting unlimited serialization are as follows: security, performance, and objects not amenable to serialization.
42. You initiate serialization by creating an `ObjectOutputStream` instance and calling its `writeObject()` method. You initiate deserialization by creating an `ObjectInputStream` instance and calling its `readObject()` method.
43. The answer is false: class fields are not automatically serialized.
44. The purpose of the `transient` reserved word is to mark instance fields that don't participate in default serialization and default deserialization.
45. The deserialization mechanism causes `readObject()` to throw an instance of the `InvalidClassException` class when it attempts to deserialize an object whose class has changed.
46. The deserialization mechanism detects that a serialized object's class has changed as follows: every serialized object has an identifier, and the deserialization mechanism compares the identifier of the object being deserialized with the serialized identifier of its class (all serializable classes are automatically given unique identifiers unless they explicitly specify their own identifiers) and causes `InvalidClassException` to be thrown when it detects a mismatch.
47. You can add an instance field to a class and avoid trouble when deserializing an object that was serialized before the instance field was added by introducing a `long serialVersionUID = long integer value;` declaration into the class. The *long integer value* must be unique, and it is known as a stream unique identifier (SUID). You can use the JDK's `serialver` tool to help with this task.
48. You customize the default serialization and deserialization mechanisms without using externalization by declaring `private void writeObject(ObjectOutputStream)` and `void readObject(ObjectInputStream)` methods in the class.
49. You tell the serialization and deserialization mechanisms to serialize or deserialize the object's normal state before serializing or deserializing additional data items by first calling `ObjectOutputStream`'s `defaultWriteObject()` method in `writeObject(ObjectOutputStream)` and by first calling `ObjectInputStream`'s `defaultReadObject()` method in `readObject(ObjectInputStream)`.
50. Externalization differs from default and custom serialization and deserialization in that it offers complete control over the serialization and deserialization tasks.

51. A class indicates that it supports externalization by implementing the Externalizable interface instead of Serializable and by declaring void writeExternal(ObjectOutput) and void readExternal(ObjectInput in) methods instead of void writeObject(ObjectOutputStream) and void readObject(ObjectInputStream) methods.
52. The answer is true: during externalization, the deserialization mechanism throws InvalidClassException with a “no valid constructor” message when it doesn’t detect a public noargument constructor.
53. The difference between PrintStream’s print() and println() methods is that the print() methods don’t append a line terminator to their output, whereas the println() methods append a line terminator.
54. PrintStream’s noargument void println() method outputs the line.separator system property’s value to ensure that lines are terminated in a portable manner (such as a carriage return followed by a newline/line feed on Windows, or only a newline/line feed on Unix/Linux).
55. Java’s stream classes are not good at streaming characters because bytes and characters are two different things: a byte represents an 8-bit data item and a character represents a 16-bit data item. Also, byte streams have no knowledge of character sets and their character encodings.
56. Java provides writer and reader classes as the preferred alternative to stream classes when it comes to character I/O.
57. The answer is false: Reader doesn’t declare an available() method.
58. The purpose of the OutputStreamWriter class is to serve as a bridge between an incoming sequence of characters and an outgoing stream of bytes. Characters written to this writer are encoded into bytes according to the default or specified character encoding. The purpose of the InputStreamReader class is to serve as a bridge between an incoming stream of bytes and an outgoing sequence of characters. Characters read from this reader are decoded from bytes according to the default or specified character encoding.
59. You identify the default character encoding by reading the value of the file.encoding system property.
60. The purpose of the FileWriter class is to connect conveniently to the underlying file output stream using the default character encoding. The purpose of the FileReader class is to connect conveniently to the underlying file input stream using the default character encoding.
61. Listing A-51 presents the Touch application that was called for in Chapter 11.

*Listing A-51. Setting a File or Directory's Timestamp to the Current Time*

```
import java.io.File;

import java.util.Date;

public class Touch
{
    public static void main(String[] args)
    {
        if (args.length != 1)
        {
            System.err.println("usage: java Touch pathname");
            return;
        }
        new File(args[0]).setLastModified(new Date().getTime());
    }
}
```

62. Listing A-52 presents the Copy application that was called for in Chapter 11.

*Listing A-52. Copying a Source File to a Destination File with Buffered I/O*

```
import java.io.BufferedInputStream;
import java.io.BufferedOutputStream;
import java.io.FileInputStream;
import java.io.FileNotFoundException;
import java.io.FileOutputStream;
import java.io.IOException;

public class Copy
{
    public static void main(String[] args)
    {
        if (args.length != 2)
        {
            System.err.println("usage: java Copy srcfile dstfile");
            return;
        }
        BufferedInputStream bis = null;
        BufferedOutputStream bos = null;
        try
        {
            FileInputStream fis = new FileInputStream(args[0]);
            bis = new BufferedInputStream(fis);
            FileOutputStream fos = new FileOutputStream(args[1]);
            bos = new BufferedOutputStream(fos);
            int b; // I chose b instead of byte because byte is a reserved word.
            while ((b = bis.read()) != -1)
                bos.write(b);
        }
    }
}
```

```
catch (FileNotFoundException fnfe)
{
    System.err.println(args[0] + " could not be opened for input, or " +
        args[1] + " could not be created for output");
}
catch (IOException ioe)
{
    System.err.println("I/O error: " + ioe.getMessage());
}
finally
{
    if (bis != null)
        try
        {
            bis.close();
        }
        catch (IOException ioe)
        {
            assert false; // shouldn't happen in this context
        }

    if (bos != null)
        try
        {
            bos.close();
        }
        catch (IOException ioe)
        {
            assert false; // shouldn't happen in this context
        }
}
}
```

63. Listing A-53 presents the `Split` application that was called for in Chapter 11.

*Listing A-53. Splitting a Large File into Numerous Smaller Part Files*

```
import java.io.BufferedInputStream;
import java.io.BufferedOutputStream;
import java.io.File;
import java.io.FileInputStream;
import java.io.FileOutputStream;
import java.io.IOException;

public class Split
{
    static final int FILESIZE = 1400000;
    static byte[] buffer = new byte[FILESIZE];
```

```
public static void main(String[] args)
{
    if (args.length != 1)
    {
        System.err.println("usage: java Split pathname");
        return;
    }
    File file = new File(args[0]);
    long length = file.length();
    int nWholeParts = (int) (length / FILESIZE);
    int remainder = (int) (length % FILESIZE);
    System.out.printf("Splitting %s into %d parts%n", args[0],
        (remainder == 0) ? nWholeParts : nWholeParts + 1);
    BufferedInputStream bis = null;
    BufferedOutputStream bos = null;
    try
    {
        FileInputStream fis = new FileInputStream(args[0]);
        bis = new BufferedInputStream(fis);
        for (int i = 0; i < nWholeParts; i++)
        {
            bis.read(buffer);
            System.out.println("Writing part " + i);
            FileOutputStream fos = new FileOutputStream("part" + i);
            bos = new BufferedOutputStream(fos);
            bos.write(buffer);
            bos.close();
            bos = null;
        }
        if (remainder != 0)
        {
            int br = bis.read(buffer);
            if (br != remainder)
            {
                System.err.println("Last part mismatch: expected " + remainder
                    + " bytes");
                System.exit(0);
            }
            System.out.println("Writing part " + nWholeParts);
            FileOutputStream fos = new FileOutputStream("part" + nWholeParts);
            bos = new BufferedOutputStream(fos);
            bos.write(buffer, 0, remainder);
        }
    }
    catch (IOException ioe)
    {
        ioe.printStackTrace();
    }
}
```

```

finally
{
    if (bis != null)
        try
        {
            bis.close();
        }
        catch (IOException ioe)
        {
            assert false; // shouldn't happen in this context
        }
    if (bos != null)
        try
        {
            bos.close();
        }
        catch (IOException ioe)
        {
            assert false; // shouldn't happen in this context
        }
    }
}
}

```

64. Listing A-54 presents the CircleInfo application that was called for in Chapter 11.

*Listing A-54. Reading Lines of Text from Standard Input That Represent Circle Radii and Outputting Circumference and Area Based on the Current Radius*

```

import java.io.BufferedReader;
import java.io.InputStreamReader;
import java.io.IOException;

public class CircleInfo
{
    public static void main(String[] args) throws IOException
    {
        InputStreamReader isr = new InputStreamReader(System.in);
        BufferedReader br = new BufferedReader(isr);
        while (true)
        {
            System.out.print("Enter circle's radius: ");
            String str = br.readLine();
            double radius;
            try
            {
                radius = Double.valueOf(str).doubleValue();
                if (radius <= 0)
                    System.err.println("radius must not be 0 or negative");
                else
                {
                    System.out.println("Circumference: " + Math.PI * 2.0 * radius);
                }
            }
        }
    }
}

```

```
        System.out.println("Area: " + Math.PI * radius * radius);
        System.out.println();
    }
}
catch (NumberFormatException nfe)
{
    System.err.println("not a number: " + nfe.getMessage());
}
}
}
```

## Chapter 12: Accessing Networks

1. A network is a group of interconnected nodes that can be shared among the network's users.
2. An intranet is a network located within an organization, and an internet is a network connecting organizations to each other.
3. Intranets and internets often use TCP/IP to communicate between nodes. Transmission Control Protocol (TCP) is a connection-oriented protocol, User Datagram Protocol (UDP) is a connectionless protocol, and Internet Protocol (IP) is the basic protocol over which TCP and UDP perform their tasks.
4. A host is a computer-based TCP/IP node.
5. A socket is an endpoint in a communications link between two processes.
6. A socket is identified by an IP address that identifies the host and by a port number that identifies the process running on that host.
7. An IP address is a 32-bit or 128-bit unsigned integer that uniquely identifies a network host or some other network node.
8. A packet is an addressable message chunk. Packets are often referred to as IP datagrams.
9. A socket address is comprised of an IP address and a port number.
10. The `InetAddress` subclasses that are used to represent IPv4 and IPv6 addresses are `Inet4Address` and `Inet6Address`.
11. The loopback interface is a software-based network interface where outgoing data loops back as incoming data.
12. The answer is false: in network byte order, the most significant byte comes first.
13. The local host is represented by hostname `localhost` or by an IP address that's commonly expressed as `127.0.0.1` (IPv4) or `::1` (IPv6).
14. A socket option is a parameter for configuring socket behavior.



15. Socket options are described by constants that are declared in the `SocketOptions` interface.
16. The answer is false: you don't set a socket option by calling the `void setOption(int optID, Object value)` method. Instead, you call one of the type-safe socket option methods that are declared in a `Socket`-suffixed class.
17. Sockets based on the `Socket` class are commonly referred to as stream sockets because `Socket` is associated with the `InputStream` and `OutputStream` classes.
18. In the context of a `Socket` instance, binding makes a client socket address available to a server socket so that a server process can communicate with the client process via the server socket.
19. A proxy is a host that sits between an intranet and the Internet for security purposes. Java represents proxy settings via instances of the `java.net.Proxy` class.
20. The answer is false: the `ServerSocket()` constructor creates an unbound server socket.
21. The difference between the `DatagramSocket` and `MulticastSocket` classes is as follows: `DatagramSocket` lets you perform UDP-based communications between a pair of hosts, whereas `MulticastSocket` lets you perform UDP-based communications between many hosts.
22. A datagram packet is an array of bytes associated with an instance of the `DatagramPacket` class.
23. The difference between unicasting and multicasting is as follows: unicasting is the act of a server sending a message to a single client, whereas multicasting is the act of a server sending a message to multiple clients.
24. A URL is a character string that specifies where a resource (such as a web page) is located on a TCP/IP-based network (such as the Internet). Also, it provides the means to retrieve that resource.
25. A URN is a character string that names a resource and doesn't provide a way to access that resource (the resource might not be available).
26. The answer is true: URLs and URNs are also URIs.
27. The `URL(String s)` constructor throws `MalformedURLException` when you pass null to `s`.
28. The equivalent of `openStream()` is to execute `openConnection().getInputStream()`.
29. The answer is false: you don't need to invoke `URLConnection`'s `void setDoInput(boolean doInput)` method with `true` as the argument before you can input content from a web resource. The default setting is `true`.

30. When it encounters a space character, `URLEncoder` converts it to a plus sign.
31. The purpose of the `URI` class is to represent names (URNs) and resources (URLs). Also, it provides normalization, resolution, and relativization operations; the resulting URI can be converted into a URL as long as it represents a resource.
32. Normalization is the process of removing unnecessary “.” and “..” path segments from a hierarchical URI’s path component. Each “.” segment is removed. A “..” segment is removed only when it’s preceded by a non-“..” segment.
33. The answer is true: resolution and relativization are inverse operations of each other.
34. The `NetworkInterface` class represents a network interface as a name and a list of IP addresses assigned to this interface. Furthermore, it’s used to identify the local interface on which a multicast group is joined.
35. A MAC address is an array of bytes containing a network interface’s hardware address.
36. MTU stands for Maximum Transmission Unit. This size represents the maximum length of a message that can fit into an IP datagram without needing to fragment the message into multiple IP datagrams.
37. The answer is false: `NetworkInterface`’s `getName()` method returns a network interface’s name (such as `eth0` or `lo`), not a human-readable display name.
38. `InterfaceAddress`’s `getNetworkPrefixLength()` method returns the subnet mask under IPv4.
39. HTTP cookie (cookie for short) is a state object.
40. It’s preferable to store cookies on the client rather than on the server because of the potential for millions of cookies (depending on a web site’s popularity).
41. The four `java.net` types that are used to work with cookies are `CookieHandler`, `CookieManager`, `CookiePolicy`, and `CookieStore`.
42. Listing A-55 presents the enhanced `EchoClient` application that was called for in Chapter 12.

*Listing A-55. Echoing Data to and Receiving It Back from a Server and Explicitly Closing the Socket*

```
import java.io.BufferedReader;
import java.io.InputStream;
import java.io.InputStreamReader;
import java.io.IOException;
import java.io.OutputStream;
import java.io.OutputStreamWriter;
import java.io.PrintWriter;
```

```
import java.net.Socket;
import java.net.UnknownHostException;

public class EchoClient
{
    public static void main(String[] args)
    {
        if (args.length != 1)
        {
            System.err.println("usage : java EchoClient message");
            System.err.println("example: java EchoClient \"This is a test.\");
            return;
        }
        Socket socket = null;
        try
        {
            socket = new Socket("localhost", 9999);
            OutputStream os = socket.getOutputStream();
            OutputStreamWriter osw = new OutputStreamWriter(os);
            PrintWriter pw = new PrintWriter(osw);
            pw.println(args[0]);
            pw.flush();
            InputStream is = socket.getInputStream();
            InputStreamReader isr = new InputStreamReader(is);
            BufferedReader br = new BufferedReader(isr);
            System.out.println(br.readLine());
        }
        catch (UnknownHostException uhe)
        {
            System.err.println("unknown host: " + uhe.getMessage());
        }
        catch (IOException ioe)
        {
            System.err.println("I/O error: " + ioe.getMessage());
        }
        finally
        {
            if (socket != null)
            try
            {
                socket.close();
            }
            catch (IOException ioe)
            {
                assert false; // shouldn't happen in this context
            }
        }
    }
}
```

43. Listing A-56 presents the enhanced EchoServer application that was called for in Chapter 12.

*Listing A-56. Receiving Data from and Echoing It Back to a Client and Explicitly Closing the Socket After a kill File Appears*

```
import java.io.BufferedReader;
import java.io.File;
import java.io.InputStream;
import java.io.InputStreamReader;
import java.io.IOException;
import java.io.OutputStream;
import java.io.OutputStreamWriter;
import java.io.PrintWriter;

import java.net.ServerSocket;
import java.net.Socket;

public class EchoServer
{
    public static void main(String[] args)
    {
        System.out.println("Starting echo server...");
        ServerSocket ss = null;
        try
        {
            ss = new ServerSocket(9999);
            File file = new File("kill");
            while (!file.exists())
            {
                Socket s = ss.accept(); // waiting for client request
                try
                {
                    InputStream is = s.getInputStream();
                    InputStreamReader isr = new InputStreamReader(is);
                    BufferedReader br = new BufferedReader(isr);
                    String msg = br.readLine();
                    System.out.println(msg);
                    OutputStream os = s.getOutputStream();
                    OutputStreamWriter osw = new OutputStreamWriter(os);
                    PrintWriter pw = new PrintWriter(osw);
                    pw.println(msg);
                    pw.flush();
                }
                catch (IOException ioe)
                {
                    System.err.println("I/O error: " + ioe.getMessage());
                }
            }
        }
    }
}
```

```

        finally
        {
            try
            {
                s.close();
            }
            catch (IOException ioe)
            {
                assert false; // shouldn't happen in this context
            }
        }
    }
}
catch (IOException ioe)
{
    System.err.println("I/O error: " + ioe.getMessage());
}
finally
{
    if (ss != null)
        try
        {
            ss.close();
        }
        catch (IOException ioe)
        {
            assert false; // shouldn't happen in this context
        }
}
}
}

```

## Chapter 13: Migrating to New I/O

1. New I/O is a more powerful I/O architecture that supports memory-mapped file I/O, readiness selection, file locking, and more. This architecture largely consists of buffers, channels, selectors, regular expressions, and charsets, but it also could be considered to include a printf-style formatting facility.
2. A buffer is an object that stores a fixed amount of data to be sent to or received from an I/O service (a means for performing input/output). It sits between an application and a channel that writes the buffered data to the service or reads the data from the service and deposits it into the buffer.
3. A buffer's four properties are capacity, limit, position, and mark.
4. When you invoke Buffer's array() method on a buffer backed by a read-only array, this method throws ReadOnlyBufferException.

5. When you invoke `Buffer`'s `flip()` method on a buffer, the limit is set to the current position and then the position is set to zero. When the mark is defined, it's discarded. The buffer is now ready to be drained.
6. When you invoke `Buffer`'s `reset()` method on a buffer where a mark has not been set, this method throws `InvalidMarkException`.
7. The answer is false: buffers are not thread-safe.
8. The classes that extend the abstract `Buffer` class are `ByteBuffer`, `CharBuffer`, `DoubleBuffer`, `FloatBuffer`, `IntBuffer`, `LongBuffer`, and `ShortBuffer`. Furthermore, this package includes `MappedByteBuffer` as an abstract `ByteBuffer` subclass.
9. You create a byte buffer by invoking one of its `allocate()`, `allocateDirect()`, or `wrap()` class methods.
10. A view buffer is a buffer that manages another buffer's data.
11. A view buffer is created by calling a `Buffer` subclass's `duplicate()` method.
12. You create a read-only view buffer by calling a `Buffer` subclass method such as `ByteBuffer` `asReadOnlyBuffer()` or `CharBuffer` `asReadOnlyBuffer()`.
13. `ByteBuffer`'s methods for storing a single byte in a byte buffer are `ByteBuffer` `put(int index, byte b)` and `ByteBuffer` `put(byte b)`. `ByteBuffer`'s methods for fetching a single byte from a byte buffer are `byte` `get(int index)` and `byte` `get()`.
14. Attempting to use the relative `put()` method or the relative `get()` method when the current position is greater than or equal to the limit causes `BufferOverflowException` or `BufferUnderflowException` to occur.
15. The equivalent of executing `buffer.flip()`; is to execute `buffer.limit(buffer.position()).position(0)`;
16. The answer is false: calling `flip()` twice doesn't return you to the original state. Instead, the buffer has a zero size.
17. The difference between `Buffer`'s `clear()` and `reset()` methods is as follows: the `clear()` method marks a buffer as empty, whereas `reset()` changes the buffer's current position to the previously set mark or throws `InvalidMarkException` when there's no previously set mark.
18. `ByteBuffer`'s `compact()` method compacts a buffer by copying all bytes between the current position and the limit to the beginning of the buffer. The byte at index  $p = \text{position}()$  is copied to index 0, the byte at index  $p + 1$  is copied to index 1, and so on until the byte at index  $\text{limit}() - 1$  is copied to index  $n = \text{limit}() - 1 - p$ . The buffer's current position is then set to  $n + 1$  and its limit is set to its capacity. The mark, when defined, is discarded.

19. The purpose of the `ByteOrder` class is to help you deal with byte-order issues when writing/reading multibyte values to/from a multibyte buffer.
20. A direct byte buffer is a byte buffer that interacts with channels and native code to perform I/O. The direct byte buffer attempts to store byte elements in a memory area that a channel uses to perform direct (raw) access via native code that tells the operating system to drain or fill the memory area directly.
21. You obtain a direct byte buffer by invoking `ByteBuffer`'s `allocateDirect()` method.
22. A channel is an object that represents an open connection to a hardware device, a file, a network socket, an application component, or another entity that's capable of performing write, read, and other I/O operations. Channels efficiently transfer data between byte buffers and I/O service sources or destinations.
23. The capabilities that the `Channel` interface provides are closing a channel (via the `close()` method) and determining whether or not a channel is open (via the `isOpen()` method.)
24. The three interfaces that directly extend `Channel` are `WritableByteChannel`, `ReadableByteChannel`, and `InterruptibleChannel`.
25. The answer is true: a channel that implements `InterruptibleChannel` is asynchronously closeable.
26. The two ways to obtain a channel are to invoke a `Channels` class method, such as `WritableByteChannel newChannel(OutputStream outputStream)`, and to invoke a channel method on a classic I/O class, such as `RandomAccessFile`'s `FileChannel getChannel()` method.
27. Scatter/gather I/O is the ability to perform a single I/O operation across multiple buffers.
28. The `ScatteringByteChannel` and `GatheringByteChannel` interfaces are provided for achieving scatter/gather I/O.
29. A file channel is a channel to an underlying file.
30. The answer is false: file channels support scatter/gather I/O.
31. An exclusive lock is a lock that prevents other file locks from being used within the region governed by the exclusive lock. In contrast, a shared lock is a lock that may apply to a region governed by other shared locks.
32. The fundamental difference between `FileChannel`'s `lock()` and `tryLock()` methods is that the `lock()` methods can block and the `tryLock()` methods never block.

33. The `FileLock lock()` method throws `OverlappingFileLockException` when either a lock is already held that overlaps this lock request or another thread is waiting to acquire a lock that will overlap with this request.
34. The pattern that you should adopt to ensure that an acquired file lock is always released follows:

```
FileLock lock = fileChannel.lock();
try
{
    // interact with the file channel
}
catch (IOException ioe)
{
    // handle the exception
}
finally
{
    lock.release();
}
```

35. `FileChannel` provides the `MappedByteBuffer map(FileChannel.MapMode mode, long position, long size)` method for mapping a region of a file into memory.
36. The three file-mapping modes are read-only, read-write, and private. They're described by the `READ_ONLY`, `READ_WRITE`, and `PRIVATE` constants declared by the `FileChannel.MapMode` enumerated type.
37. The private file-mapping mode corresponds to copy-on-write. Changes made to the resulting buffer will not be propagated to the file and will not be visible to other programs that have mapped the same file. Instead, changes will cause private copies of the modified portions of the buffer to be created. These changes are lost when the buffer is garbage collected.
38. The `FileChannel` methods that optimize the common practice of performing bulk transfers are `transferFrom()` and `transferTo()`.
39. The answer is true: socket channels are selectable and can function in nonblocking mode.
40. The three classes that describe socket channels are `ServerSocketChannel`, `SocketChannel`, and `DatagramChannel`.
41. The answer is false: datagram channels are thread-safe.
42. Socket channels support nonblocking mode because the blocking nature of sockets created from Java's socket classes is a serious limitation to a network-oriented Java application's scalability.
43. You would obtain a socket channel's associated socket by invoking its `socket()` method.



44. You obtain a server socket channel by invoking `ServerSocketChannel`'s `open()` class method.
45. A selector is an object created from a subclass of the abstract `Selector` class. It maintains a set of channels, which it examines to determine which of them are ready for reading, writing, completing a connection sequence, accepting another connection, or some combination of these tasks. The actual work is delegated to the operating system via a POSIX `select()` or similar system call.
46. The three main types that support selectors are `SelectableChannel`, `SelectionKey`, and `Selector`.
47. The answer is false: file channels cannot be used with selectors. Only channels that implement `SelectableChannel` can be used with selectors. `FileChannel` doesn't implement `SelectableChannel`.
48. A regular expression (also known as a regex or regexp) is a string-based pattern that represents the set of strings that match this pattern.
49. Instances of the `Pattern` class represent patterns via compiled regexes. Regexes are compiled for performance reasons; pattern matching via compiled regexes is much faster than if the regexes were not compiled.
50. `Pattern`'s `compile()` methods throw `PatternSyntaxException` when they discover illegal syntax in their regular expression arguments.
51. Instances of the `Matcher` class attempt to match compiled regexes against input text.
52. The difference between `Matcher`'s `matches()` and `lookingAt()` methods is that unlike `matches()`, `lookingAt()` doesn't require the entire region to be matched.
53. A character class is a set of characters appearing between `[` and `]`.
54. There are six kinds of character classes: simple, negation, range, union, intersection, and subtraction.
55. A capturing group saves a match's characters for later recall during pattern matching.
56. A zero-length match is a match of zero length in which the start and end indexes are equal.
57. A quantifier is a numeric value implicitly or explicitly bound to a pattern. Quantifiers are categorized as greedy, reluctant, or possessive.
58. The difference between a greedy quantifier and a reluctant quantifier is that a greedy quantifier attempts to find the longest match, whereas a reluctant quantifier attempts to find the shortest match.

59. Possessive and greedy quantifiers differ in that a possessive quantifier only makes one attempt to find the longest match, whereas a greedy quantifier can make multiple attempts.
60. The two main classes that contribute to the NIO printf-style formatting facility are `Formatter` and `Scanner`.
61. The `%n` format specifier outputs a platform-specific line separator.
62. Listing A-57 presents the enhanced Copy application that was called for in Chapter 13.

*Listing A-57. Copying a File via a Byte Buffer and a File Channel*

```
import java.io.FileInputStream;
import java.io.FileNotFoundException;
import java.io.FileOutputStream;
import java.io.IOException;

import java.nio.ByteBuffer;

import java.nio.channels.FileChannel;

public class Copy
{
    public static void main(String[] args)
    {
        if (args.length != 2)
        {
            System.err.println("usage: java Copy srcfile dstfile");
            return;
        }
        FileChannel fcSrc = null;
        FileChannel fcDest = null;
        try
        {
            FileInputStream fis = new FileInputStream(args[0]);
            fcSrc = fis.getChannel();
            FileOutputStream fos = new FileOutputStream(args[1]);
            fcDest = fos.getChannel();
            ByteBuffer buffer = ByteBuffer.allocateDirect(2048);
            while ((fcSrc.read(buffer)) != -1)
            {
                buffer.flip();
                while (buffer.hasRemaining())
                    fcDest.write(buffer);
                buffer.clear();
            }
        }
    }
}
```

```
catch (FileNotFoundException fnfe)
{
    System.err.println(args[0] + " could not be opened for input, or " +
        args[1] + " could not be created for output");
}
catch (IOException ioe)
{
    System.err.println("I/O error: " + ioe.getMessage());
}
finally
{
    if (fcSrc != null)
        try
        {
            fcSrc.close();
        }
        catch (IOException ioe)
        {
            assert false; // shouldn't happen in this context
        }

    if (fcDest != null)
        try
        {
            fcDest.close();
        }
        catch (IOException ioe)
        {
            assert false; // shouldn't happen in this context
        }
}
}
```

63. Listing A-58 presents the ReplaceText application that was called for in Chapter 13.

*Listing A-58. Replacing All Matches of the Pattern with Replacement Text*

```
import java.util.regex.Matcher;
import java.util.regex.Pattern;
import java.util.regex.PatternSyntaxException;

public class ReplaceText
{
    public static void main(String[] args)
    {
        if (args.length != 3)
        {
            System.err.println("usage: java ReplaceText text oldText newText");
            return;
        }
    }
}
```

```

try
{
    Pattern p = Pattern.compile(args[1]);
    Matcher m = p.matcher(args[0]);
    String result = m.replaceAll(args[2]);
    System.out.println(result);
}
catch (PatternSyntaxException pse)
{
    System.err.println(pse);
}
}
}

```

64. Listing A-59 presents the `ValidateInput` application that was called for in Chapter 13.

*Listing A-59. Using a Scanner to Validate That Each Input Line Contains a String Name Followed by an Integer Age*

```

import java.util.Scanner;

public class ValidateInput
{
    public static void main(String[] args)
    {
        // Scan standard input.
        Scanner scannerInput = new Scanner(System.in);

        // Keep track of current line number.
        int lineNo = 0;

        // Scan this input on a line-by-line basis.
        while (scannerInput.hasNextLine())
        {
            // Obtain current line.
            String curLine = scannerInput.nextLine();

            // Output line.
            System.out.printf("%d: %s%n", ++lineNo, curLine);

            // Obtain a scanner to scan the current line.
            Scanner scannerLine = new Scanner(curLine);

            // Verify that the line has a name field.
            if (scannerLine.hasNext())
                System.out.printf("Name: %s%n", scannerLine.next());
            else
            {
                System.out.printf("%d: name field missing%n", lineNo);
                continue;
            }
        }
    }
}

```

```
// Verify that the line has a second age field, of type integer.
if (scannerLine.hasNextInt())
    System.out.printf("Age: %d%n", scannerLine.nextInt());
else
{
    System.out.printf("%d: age field missing%n%n", lineNo);
    continue;
}

System.out.println();

// Close current line scanner.
scannerLine.close();
}

// Close standard input scanner.
scannerInput.close();
}
}
```

## Chapter 14: Accessing Databases

1. A database is an organized collection of data.
2. A relational database is a database that organizes data into tables that can be related to each other.
3. Two other database categories are hierarchical databases and object-oriented databases.
4. A database management system is a set of programs that enables you to store, modify, and extract information from a database. It also provides users with tools to add, delete, access, modify, and analyze data stored in one location.
5. Java DB is a distribution of Apache's open-source Derby product, which is based on IBM's Cloudscape RDBMS code base.
6. The answer is false: Java DB's embedded driver causes the database engine to run in the same virtual machine as the application.
7. `setEmbeddedCP` adds `derby.jar` and `derbytools.jar` to the classpath so that you can access Java DB's embedded driver from your application.
8. The answer is false: you run Java DB's `sysinfo` command-line tool to view the Java environment/Java DB configuration.
9. SQLite is a very simple and popular RDBMS that implements a self-contained, serverless, zero-configuration, transactional SQL database engine, and it is considered to be the most widely deployed database engine in the world.

10. Manifest typing is the ability to store any value of any data type into any column regardless of the declared type of that column.
11. SQLite provides the `sqlite3` tool for accessing and modifying SQLite databases.
12. JDBC is an API for communicating with RDBMSes in an RDBMS-independent manner.
13. A data source is a data-storage facility ranging from a simple file to a complex relational database managed by an RDBMS.
14. A JDBC driver implements the `java.sql.Driver` interface.
15. The answer is false: there are four kinds of JDBC drivers.
16. A type three JDBC driver doesn't depend on native code and communicates with a middleware server via an RDBMS-independent protocol. The middleware server then communicates the client's requests to the data source.
17. JDBC provides the `java.sql.DriverManager` class and the `javax.sql.DataSource` interface for communicating with a data source.
18. You obtain a connection to a Java DB data source via the embedded driver by passing a URL of the form `jdbc:derby:databaseName; URLAttributes` to one of `DriverManager`'s `getConnection()` methods.
19. The answer is false: `int getErrorCode()` returns a vendor-specific error code.
20. A SQL state error code is a five-character string consisting of a two-character class value followed by a three-character subclass value.
21. The difference between `SQLNonTransientException` and `SQLTransientException` is as follows: `SQLNonTransientException` describes failed operations that cannot be retried without changing application source code or some aspect of the data source, and `SQLTransientException` describes failed operations that can be retried immediately.
22. JDBC's three statement types are `Statement`, `PreparedStatement`, and `CallableStatement`.
23. The `Statement` method that you call to execute an SQL SELECT statement is `ResultSet executeQuery(String sql)`.
24. A result set's cursor provides access to a specific row of data.
25. The SQL `FLOAT` type maps to Java's `double` type.
26. A prepared statement represents a precompiled SQL statement.
27. The answer is true: `CallableStatement` extends `PreparedStatement`.
28. A stored procedure is a list of SQL statements that perform a specific task.

29. You call a stored procedure by first obtaining a `CallableStatement` implementation instance (via one of `Connection`'s `prepareCall()` methods) that's associated with an escape clause, by next executing `CallableStatement` methods such as `void setInt(String parameterName, int x)` to pass arguments to escape clause parameters, and by finally invoking the boolean `execute()` method that `CallableStatement` inherits from its `PreparedStatement` superinterface.
30. An escape clause is RDBMS-independent syntax.
31. Metadata is data about data.
32. Metadata includes a list of catalogs, base tables, views, indexes, schemas, and additional information.
33. Listing A-60 presents the enhanced JDBCdemo application that was called for in Chapter 14.

*Listing A-60. Outputting Database Metadata for the SQLite or Java DB Embedded Driver*

```
import java.sql.Connection;
import java.sql.DatabaseMetaData;
import java.sql.DriverManager;
import java.sql.ResultSet;
import java.sql.SQLException;
import java.sql.Statement;

public class JDBCdemo
{
    final static String URL1 = "jdbc:derby:employee;create=true";
    final static String URL2 = "jdbc:sqlite:employee";

    public static void main(String[] args)
    {
        String url = null;
        if (args.length != 1)
        {
            System.err.println("usage 1: java JDBCdemo javadb");
            System.err.println("usage 2: java JDBCdemo sqlite");
            return;
        }
        if (args[0].equals("javadb"))
            url = URL1;
        else
        if (args[0].equals("sqlite"))
            url = URL2;
        else
        {
            System.err.println("invalid command-line argument");
            return;
        }
    }
}
```

```

Connection con = null;
try
{
    if (args[0].equals("sqlite"))
        Class.forName("org.sqlite.JDBC");
    con = DriverManager.getConnection(url);
    dump(con.getMetaData());
}
catch (ClassNotFoundException cnfe)
{
    System.err.println("unable to load sqlite driver");
}
catch (SQLException sqllex)
{
    while (sqllex != null)
    {
        System.err.println("SQL error : " + sqllex.getMessage());
        System.err.println("SQL state : " + sqllex.getSQLState());
        System.err.println("Error code: " + sqllex.getErrorCode());
        System.err.println("Cause: " + sqllex.getCause());
        sqllex = sqllex.getNextException();
    }
}
finally
{
    if (con != null)
        try
        {
            con.close();
        }
        catch (SQLException sqle)
        {
            sqle.printStackTrace();
        }
}
}

static void dump(DatabaseMetaData dbmd) throws SQLException
{
    System.out.println("DB Major Version = " + dbmd.getDatabaseMajorVersion());
    System.out.println("DB Minor Version = " + dbmd.getDatabaseMinorVersion());
    System.out.println("DB Product = " + dbmd.getDatabaseProductName());
    System.out.println("Driver Name = " + dbmd.getDriverName());
    System.out.println("Numeric function names for escape clause = " +
        dbmd.getNumericFunctions());
    System.out.println("String function names for escape clause = " +
        dbmd.getStringFunctions());
    System.out.println("System function names for escape clause = " +
        dbmd.getSystemFunctions());
    System.out.println("Time/date function names for escape clause = " +
        dbmd.getTimeDateFunctions());
    System.out.println("Catalog term: " + dbmd.getCatalogTerm());
}

```



```

System.out.println("Schema term: " + dbmd.getSchemaTerm());
System.out.println();
System.out.println("Catalogs");
System.out.println("-----");
ResultSet rsCat = dbmd.getCatalogs();
while (rsCat.next())
    System.out.println(rsCat.getString("TABLE_CAT"));
System.out.println();
System.out.println("Schemas");
System.out.println("-----");
ResultSet rsSchem = dbmd.getSchemas();
while (rsSchem.next())
    System.out.println(rsSchem.getString("TABLE_SCHEM"));
System.out.println();
System.out.println("Schema/Table");
System.out.println("-----");
rsSchem = dbmd.getSchemas();
while (rsSchem.next())
{
    String schem = rsSchem.getString("TABLE_SCHEM");
    ResultSet rsTab = dbmd.getTables(null, schem, "%", null);
    while (rsTab.next())
        System.out.println(schem + " " + rsTab.getString("TABLE_NAME"));
}
}
}

```

## Chapter 15: Parsing, Creating, and Transforming XML Documents

1. XML (eXtensible Markup Language) is a metalanguage for defining vocabularies (custom markup languages), which is key to XML's importance and popularity.
2. The answer is true: XML and HTML are descendents of SGML.
3. The XML declaration is special markup that informs an XML parser that the document is XML.
4. The XML declaration's three attributes are version, encoding, and standalone. The version attribute is nonoptional.
5. The answer is false: an element can consist of the empty-element tag, which is a standalone tag whose name ends with a forward slash (/), such as <break/>.
6. Following the XML declaration, an XML document is anchored in a root element.

7. Mixed content is a combination of child elements and content.
8. A character reference is a code that represents the character. The two kinds of character references are numeric character references (such as `&#x03A3;`) and character entity references (such as `&lt;`).
9. A CDATA section is a section of literal HTML or XML markup and content surrounded by the `<![CDATA[ prefix and the ]>` suffix. You would use a CDATA section when you have a large amount of HTML/XML text and don't want to replace each literal `<` (start of tag) and `&` (start of entity) character with its `&lt;` and `&amp;` predefined character entity reference, which is a tedious and possibly error prone undertaking—you might forget to replace one of these characters.
10. A namespace is a Uniform Resource Identifier-based container that helps differentiate XML vocabularies by providing a unique context for its contained identifiers.
11. A namespace prefix is an alias for the URI.
12. The answer is true: a tag's attributes don't need to be prefixed when those attributes belong to the element.
13. A comment is a character sequence beginning with `<!--` and ending with `-->`. A comment can appear anywhere in an XML document except before the XML declaration, except within tags, and except within another comment.
14. A processing instruction is an instruction that's made available to the application parsing the document. The instruction begins with `<?` and ends with `?>`.
15. The rules that an XML document must follow to be considered well formed are as follows: all elements must either have start and end tags or consist of empty-element tags, tags must be nested correctly, all attribute values must be quoted, empty elements must be properly formatted, and you must be careful with case. Furthermore, XML parsers that are aware of namespaces enforce two additional rules: all element and attribute names must not include more than one colon character; and no entity names, processing instruction targets, or notation names can contain colons.
16. For an XML document to be valid, the document must adhere to certain constraints. For example, one constraint might be that a specific element must always follow another specific element.
17. The two commonly used grammar languages are Document Type Definition and XML Schema.
18. The general syntax for declaring an element in a DTD is `<!ELEMENT name content-specifier>`.

19. XML Schema lets you create complex types from simple types.
20. SAX is an event-based API for parsing an XML document sequentially from start to finish. As a SAX-oriented parser encounters an item from the document's infoset, it makes this item available to an application as an event by calling one of the methods in one of the application's handlers, which the application has previously registered with the parser. The application can then consume this event by processing the infoset item in some manner.
21. You obtain a SAX 2-based parser by calling one of the `org.xml.sax.helpers.XMLReaderFactory` class's `createXMLReader()` methods, which returns an `XMLReader` instance.
22. The purpose of the `XMLReader` interface is to describe a SAX parser. This interface makes available several methods for configuring the SAX parser and parsing an XML document's content.
23. You tell a SAX parser to perform validation by invoking `XMLReader`'s `setFeature(String name, boolean value)` method, passing "<http://xml.org/sax/features/validation>" to name and `true` to value.
24. The four kinds of SAX-oriented exceptions that can be thrown when working with SAX are `SAXException`, `SAXNotRecognizedException`, `SAXNotSupportedException`, and `SAXParseException`.
25. The interface that a handler class implements to respond to content-oriented events is `org.xml.sax.ContentHandler`.
26. The three other core interfaces that a handler class is likely to implement are `org.xml.sax.DTDHandler`, `org.xml.sax.EntityResolver`, and `org.xml.sax.ErrorHandler`.
27. Ignorable whitespace is whitespace located between tags where the DTD doesn't allow mixed content.
28. The answer is false: `void error(SAXParseException exception)` is called only for recoverable errors.
29. The purpose of the `org.xml.sax.helpers.DefaultHandler` class is to serve as a convenience base class for SAX2 applications. It provides default implementations for all of the callbacks in the four core SAX2 handler interfaces: `ContentHandler`, `DTDHandler`, `EntityResolver`, and `ErrorHandler`.
30. An entity is aliased data. An entity resolver is an object that uses the public identifier to choose a different system identifier. Upon encountering an external entity, the parser calls the custom entity resolver to obtain this identifier.

31. DOM is an API for parsing an XML document into an in-memory tree of nodes and for creating an XML document from a tree of nodes. After a DOM parser has created a document tree, an application uses the DOM API to navigate over and extract info set items from the tree's nodes.
32. The answer is false: Java 7 and newer versions of Android support DOM Levels 1, 2, and 3.
33. The 12 different DOM nodes are attribute node, CDATA section node, comment node, document node, document fragment node, document type node, element node, entity node, entity reference node, notation node, processing instruction node, and text node.
34. You obtain a document builder by first instantiating `DocumentBuilderFactory` via one of its `newInstance()` methods and then invoking `newDocumentBuilder()` on the returned `DocumentBuilderFactory` instance to obtain a `DocumentBuilder` instance.
35. You use a document builder to parse an XML document by invoking one of `DocumentBuilder`'s `parse()` methods.
36. The answer is true: `Document` and all other `org.w3c.dom` interfaces that describe different kinds of nodes are subinterfaces of the `Node` interface.
37. You use a document builder to create a new XML document by invoking `DocumentBuilder`'s `Document newDocument()` method and by invoking `Document`'s various "create" methods.
38. When creating a new XML document, you cannot use the DOM API to specify the XML declaration's encoding attribute.
39. A push parser is a parser that pushes parsing events to an application. The application provides a handler that responds to these events. The parser invokes the handler's callback methods to execute application-specific code as XML constructs are detected. A pull parser is a parser that lets an application pull parsed XML constructs, one at a time, from the parser when these constructs are needed. Unlike a push parser, which drives the application, a pull parser is driven by the application.
40. The answer is false: Android uses XMLPULL V1 as its pull parser.
41. You obtain the pull parser by working with the `org.xmlpull.v1` package's `XmlPullParserFactory` and `XmlPullParser` types. First you invoke `XmlPullParserFactory`'s `XmlPullParserFactory newInstance()` class method to create and return a new `XmlPullParserFactory` instance for creating XML pull parsers. Next, you configure the factory instance, for example, whether or not the pull parser should be aware of namespaces. Finally, you invoke `XmlPullParserFactory`'s `XmlPullParser newPullParser()` method to create and return a new `XmlPullParser` instance using the currently configured factory parameters.

42. You use the pull parser to parse an XML document as follows: call `XmlPullParser`'s `getEventType()` method to obtain the initial event type, and then use a while loop to repeatedly pull parser events while the current event type isn't equal to `XmlPullParser.END_DOCUMENT`. Each loop iteration first processes the start document, start tag, text, or end tag event type; and then invokes `XmlPullParser`'s `next()` method to obtain the next event type.
43. XPath is a non-XML declarative query language (defined by the W3C) for selecting an XML document's infoset items as one or more nodes.
44. XPath is commonly used to simplify access to a DOM tree's nodes and, in the context of XSLT, to select those input document elements (via XPath expressions) that are to be copied to an output document.
45. The seven kinds of nodes that XPath recognizes are element, attribute, text, namespace, processing instruction, comment, and document.
46. The answer is false: XPath doesn't recognize CDATA sections.
47. XPath provides location path expressions for selecting nodes. A location path expression locates nodes via a sequence of steps starting from the context node, which is the root node or some other document node that is the current node. The returned set of nodes might be empty, or it might contain one or more nodes.
48. The answer is true: in a location path expression, you must prefix an attribute name with the @ symbol.
49. The functions that XPath provides for selecting comment, text, and processing-instruction nodes are `comment()`, `text()`, and `processing-instruction()`.
50. XPath provides wildcards for selecting unknown nodes. The \* wildcard matches any element node regardless of the node's type. It doesn't match attributes, text nodes, comments, or processing-instruction nodes. When you place a namespace prefix before the \*, only elements belonging to that namespace are matched. The `node()` wildcard is a function that matches all nodes. Finally, the @\* wildcard matches all attribute nodes.
51. You perform multiple selections by using the vertical bar (|). For example, `author/*|publisher/*` selects the children of `author` and the children of `publisher`.
52. A predicate is a square bracket-delimited Boolean expression that's tested against each selected node. If the expression evaluates to true, that node is included in the set of nodes returned by the XPath expression; otherwise, the node isn't included in the set.

53. The functions that XPath provides for working with nodesets are `last()`, `position()`, `id()`, `local-name()`, `namespace-uri()`, and `name()`.
54. The three advanced features that XPath provides to overcome limitations with the XPath 1.0 language are namespace contexts, extension functions and function resolvers, and variables and variable resolvers.
55. XSLT is a family of languages for transforming and formatting XML documents.
56. XSLT accomplishes its work by using XSLT processors and stylesheets. An XSLT processor is a software component that applies an XSLT stylesheet (an XML-based template consisting of content and transformation instructions) to an input document (without modifying the document), and copies the transformed result to a result tree, which can be output to a file or output stream, or even piped into another XSLT processor for additional transformations.
57. Listing A-61 presents the `books.xml` document file that was called for in Chapter 15.

*Listing A-61. A Document of Books*

```
<?xml version="1.0"?>
<books>
  <book isbn="0201548550" pubyear="1992">
    <title>
      Advanced C++
    </title>
    <author>
      James O. Coplien
    </author>
    <publisher>
      Addison Wesley
    </publisher>
  </book>
  <book isbn="9781430210450" pubyear="2008">
    <title>
      Beginning Groovy and Grails
    </title>
    <author>
      Christopher M. Judd
    </author>
    <author>
      Joseph Faisal Nusairat
    </author>
    <author>
      James Shingler
    </author>
  </book>
</books>
```

```

    <publisher>
      Apress
    </publisher>
  </book>
  <book isbn="0201310058" pubyear="2001">
    <title>
      Effective Java
    </title>
    <author>
      Joshua Bloch
    </author>
    <publisher>
      Addison Wesley
    </publisher>
  </book>
</books>

```

58. Listing A-62 presents the enhanced books.xml document file with an internal DTD that was called for in Chapter 15.

*Listing A-62. A DTD-Enabled Document of Books*

```

<?xml version="1.0"?>
<!DOCTYPE books [
  <!ELEMENT books (book+)>
  <!ELEMENT book (title, author+, publisher)>
  <!ELEMENT title (#PCDATA)>
  <!ELEMENT author (#PCDATA)>
  <!ELEMENT publisher (#PCDATA)>
  <!ATTLIST book isbn CDATA #REQUIRED>
  <!ATTLIST book pubyear CDATA #REQUIRED>
]>
<books>
  <book isbn="0201548550" pubyear="1992">
    <title>
      Advanced C++
    </title>
    <author>
      James O. Coplien
    </author>
    <publisher>
      Addison Wesley
    </publisher>
  </book>
  <book isbn="9781430210450" pubyear="2008">
    <title>
      Beginning Groovy and Grails
    </title>
    <author>
      Christopher M. Judd
    </author>
  </book>
</books>

```

```

    <author>
      Joseph Faisal Nusairat
    </author>
    <author>
      James Shingler
    </author>
    <publisher>
      Apress
    </publisher>
  </book>
  <book isbn="0201310058" pubyear="2001">
    <title>
      Effective Java
    </title>
    <author>
      Joshua Bloch
    </author>
    <publisher>
      Addison Wesley
    </publisher>
  </book>
</books>

```

59. Listing A-63 and Listing A-64 present the SAXSearch and Handler classes that were called for in Chapter 15.

*Listing A-63. A SAX Driver Class for Searching books.xml for a Specific Publisher's Books*

```

import java.io.FileReader;
import java.io.IOException;

import org.xml.sax.InputSource;
import org.xml.sax.SAXException;
import org.xml.sax.XMLReader;

import org.xml.sax.helpers.XMLReaderFactory;

public class SAXSearch
{
    public static void main(String[] args)
    {
        if (args.length != 1)
        {
            System.err.println("usage: java SAXSearch publisher");
            return;
        }

        try
        {
            XMLReader xmlr = XMLReaderFactory.createXMLReader();
            Handler handler = new Handler(args[0]);
            xmlr.setContentHandler(handler);

```



```

        xmlr.setErrorHandler(handler);
        xmlr.setProperty("http://xml.org/sax/properties/lexical-handler", handler);
        xmlr.parse(new InputSource(new FileReader("books.xml")));
    }
    catch (IOException ioe)
    {
        System.err.println("IOE: " + ioe);
    }
    catch (SAXException saxe)
    {
        System.err.println("SAXE: " + saxe);
    }
}
}

```

*Listing A-64. A SAX Callback Class Whose Methods Are Called by the SAX Parser*

```

import org.xml.sax.Attributes;
import org.xml.sax.SAXParseException;

import org.xml.sax.ext.DefaultHandler2;

public class Handler extends DefaultHandler2
{
    private boolean isPublisher, isTitle;

    private String isbn, publisher, pubYear, title, srchText;

    public Handler(String srchText)
    {
        this.srchText = srchText;
    }

    @Override
    public void characters(char[] ch, int start, int length)
    {
        if (isTitle)
        {
            title = new String(ch, start, length).trim();
            isTitle = false;
        }
        else
        if (isPublisher)
        {
            publisher = new String(ch, start, length).trim();
            isPublisher = false;
        }
    }
}

```

```
@Override
public void endElement(String uri, String localName, String qName)
{
    if (!localName.equals("book"))
        return;
    if (!srchText.equals(publisher))
        return;
    System.out.println("title = " + title + ", isbn = " + isbn);
}

@Override
public void error(SAXParseException saxpe)
{
    System.out.println("error() " + saxpe);
}

@Override
public void fatalError(SAXParseException saxpe)
{
    System.out.println("fatalError() " + saxpe);
}

@Override
public void startElement(String uri, String localName, String qName,
                        Attributes attributes)
{
    if (localName.equals("title"))
    {
        isTitle = true;
        return;
    }
    else
    if (localName.equals("publisher"))
    {
        isPublisher = true;
        return;
    }
    if (!localName.equals("book"))
        return;
    for (int i = 0; i < attributes.getLength(); i++)
    if (attributes.getLocalName(i).equals("isbn"))
        isbn = attributes.getValue(i);
    else
    if (attributes.getLocalName(i).equals("pubyear"))
        pubYear = attributes.getValue(i);
}

@Override
public void warning(SAXParseException saxpe)
{
    System.out.println("warning() " + saxpe);
}
}
```

60. Listing A-65 presents the DOMSearch application that was called for in Chapter 15.

*Listing A-65. The DOM Equivalent of SAXSearch and Handler*

```
import java.io.IOException;

import java.util.ArrayList;
import java.util.List;

import javax.xml.parsers.DocumentBuilder;
import javax.xml.parsers.DocumentBuilderFactory;
import javax.xml.parsers.FactoryConfigurationError;
import javax.xml.parsers.ParserConfigurationException;

import org.w3c.dom.Document;
import org.w3c.dom.Element;
import org.w3c.dom.NamedNodeMap;
import org.w3c.dom.Node;
import org.w3c.dom.NodeList;

import org.xml.sax.SAXException;

public class DOMSearch
{
    public static void main(String[] args)
    {
        if (args.length != 1)
        {
            System.err.println("usage: java DOMSearch publisher");
            return;
        }

        try
        {
            DocumentBuilderFactory dbf = DocumentBuilderFactory.newInstance();
            DocumentBuilder db = dbf.newDocumentBuilder();
            Document doc = db.parse("books.xml");
            class BookItem
            {
                String title;
                String isbn;
            }
            List<BookItem> bookItems = new ArrayList<BookItem>();
            NodeList books = doc.getElementsByTagName("book");
            for (int i = 0; i < books.getLength(); i++)
            {
                Element book = (Element) books.item(i);
                NodeList children = book.getChildNodes();
                String title = "";
                for (int j = 0; j < children.getLength(); j++)
                {
                    Node child = children.item(j);
```

```

        if (child.getNodeType() == Node.ELEMENT_NODE)
        {
            if (child.getNodeName().equals("title"))
                title = child.getFirstChild().getNodeValue().trim();
            else
            if (child.getNodeName().equals("publisher"))
            {
                // Compare publisher name argument (args[0]) with text of
                // publisher's child text node. The trim() method call
                // removes whitespace that would interfere with the
                // comparison.
                if (args[0].equals(child.getFirstChild().getNodeValue().
                    trim()))
                {
                    BookItem bookItem = new BookItem();
                    bookItem.title = title;
                    NamedNodeMap nnm = book.getAttributes();
                    Node isbn = nnm.getNamedItem("isbn");
                    bookItem.isbn = isbn.getNodeValue();
                    bookItems.add(bookItem);
                    break;
                }
            }
        }
    }
}
for (BookItem bookItem: bookItems)
    System.out.println("title = " + bookItem.title + ", isbn = " +
        bookItem.isbn);
}
catch (IOException ioe)
{
    System.err.println("IOE: " + ioe);
}
catch (SAXException saxe)
{
    System.err.println("SAXE: " + saxe);
}
catch (FactoryConfigurationError fce)
{
    System.err.println("FCE: " + fce);
}
catch (ParserConfigurationException pce)
{
    System.err.println("PCE: " + pce);
}
}
}
}

```

61. Listing A-66 and Listing A-67 present the `contacts.xml` document file and XPathSearch application that were called for in Chapter 15.

*Listing A-66. A Contacts Document with a Titlecased Name Element*

```
<?xml version="1.0"?>
<contacts>
  <contact>
    <Name>John Doe</Name>
    <city>Chicago</city>
    <city>Denver</city>
  </contact>
  <contact>
    <name>Jane Doe</name>
    <city>New York</city>
  </contact>
  <contact>
    <name>Sandra Smith</name>
    <city>Denver</city>
    <city>Miami</city>
  </contact>
  <contact>
    <name>Bob Jones</name>
    <city>Chicago</city>
  </contact>
</contacts>
```

*Listing A-67. Searching for name or Name Elements via a Multiple Selection*

```
import java.io.IOException;

import javax.xml.parsers.DocumentBuilder;
import javax.xml.parsers.DocumentBuilderFactory;
import javax.xml.parsers.FactoryConfigurationError;
import javax.xml.parsers.ParserConfigurationException;

import javax.xml.xpath.XPath;
import javax.xml.xpath.XPathConstants;
import javax.xml.xpath.XPathException;
import javax.xml.xpath.XPathExpression;
import javax.xml.xpath.XPathFactory;

import org.w3c.dom.Document;
import org.w3c.dom.NodeList;

import org.xml.sax.SAXException;

public class XPathSearch
{
    public static void main(String[] args)
    {
        try
```

```

    {
        DocumentBuilderFactory dbf = DocumentBuilderFactory.newInstance();
        DocumentBuilder db = dbf.newDocumentBuilder();
        Document doc = db.parse("contacts.xml");
        XPathFactory xpf = XPathFactory.newInstance();
        XPath xp = xpf.newXPath();
        XPathExpression xpe;
        xpe = xp.compile("//contact[city = 'Chicago']/name/text()" +
            "//contact[city = 'Chicago']/Name/text()");
        Object result = xpe.evaluate(doc, XPathConstants.NODESET);
        NodeList nl = (NodeList) result;
        for (int i = 0; i < nl.getLength(); i++)
            System.out.println(nl.item(i).getNodeValue());
    }
    catch (IOException ioe)
    {
        System.err.println("IOE: " + ioe);
    }
    catch (SAXException saxe)
    {
        System.err.println("SAXE: " + saxe);
    }
    catch (FactoryConfigurationError fce)
    {
        System.err.println("FCE: " + fce);
    }
    catch (ParserConfigurationException pce)
    {
        System.err.println("PCE: " + pce);
    }
    catch (XPathException xpe)
    {
        System.err.println("XPE: " + xpe);
    }
}
}

```

62. Listing A-68 and Listing A-69 present the `books.xml` document stylesheet file and MakeHTML application that were called for in Chapter 15.

*Listing A-68. A Stylesheet for Converting books.xml Content to HTML*

```

<?xml version="1.0"?>
<xsl:stylesheet version="1.0"
    xmlns:xsl="http://www.w3.org/1999/XSL/Transform">
<xsl:template match="/books">
<html>
<head>
<title>Books</title>
</head>

```

```
<body>
<xsl:for-each select="book">
<h2>
<xsl:value-of select="normalize-space(title/text())"/>
</h2>
ISBN: <xsl:value-of select="@isbn"/><br/>
Publication Year: <xsl:value-of select="@pubyear"/><br/>
<br/><xsl:text>
</xsl:text>
<xsl:for-each select="author">
<xsl:value-of select="normalize-space(text())"/><br/><xsl:text>
</xsl:text>
</xsl:for-each>
</xsl:for-each>
</body>
</html>
</xsl:template>
</xsl:stylesheet>
```

*Listing A-69. Converting books.xml to HTML via a Stylesheet*

```
import java.io.FileReader;
import java.io.IOException;

import javax.xml.parsers.DocumentBuilder;
import javax.xml.parsers.DocumentBuilderFactory;
import javax.xml.parsers.FactoryConfigurationError;
import javax.xml.parsers.ParserConfigurationException;

import javax.xml.transform.OutputKeys;
import javax.xml.transform.Result;
import javax.xml.transform.Source;
import javax.xml.transform.Transformer;
import javax.xml.transform.TransformerConfigurationException;
import javax.xml.transform.TransformerException;
import javax.xml.transform.TransformerFactory;
import javax.xml.transform.TransformerFactoryConfigurationError;

import javax.xml.transform.dom.DOMSource;

import javax.xml.transform.stream.StreamResult;
import javax.xml.transform.stream.StreamSource;

import org.w3c.dom.Document;

import org.xml.sax.SAXException;

public class MakeHTML
{
    public static void main(String[] args)
    {
        try
```

```
{
    DocumentBuilderFactory dbf = DocumentBuilderFactory.newInstance();
    DocumentBuilder db = dbf.newDocumentBuilder();
    Document doc = db.parse("books.xml");
    TransformerFactory tf = TransformerFactory.newInstance();
    StreamSource ssStyleSheet;
    ssStyleSheet = new StreamSource(new FileReader("books.xsl"));
    Transformer t = tf.newTransformer(ssStyleSheet);
    t.setOutputProperty(OutputKeys.METHOD, "html");
    t.setOutputProperty(OutputKeys.INDENT, "yes");
    Source source = new DOMSource(doc);
    Result result = new StreamResult(System.out);
    t.transform(source, result);
}
catch (IOException ioe)
{
    System.err.println("IOE: " + ioe);
}
catch (FactoryConfigurationError fce)
{
    System.err.println("FCE: " + fce);
}
catch (ParserConfigurationException pce)
{
    System.err.println("PCE: " + pce);
}
catch (SAXException sax)
{
    System.err.println("SAXE: " + sax);
}
catch (TransformerConfigurationException tce)
{
    System.err.println("TCE: " + tce);
}
catch (TransformerException te)
{
    System.err.println("TE: " + te);
}
catch (TransformerFactoryConfigurationError tfce)
{
    System.err.println("TFCE: " + tfce);
}
}
```



## Chapter 16: Focusing on Odds and Ends

1. The two enhancements to numeric literals introduced by Java 7 are binary integer literals and underscores in numeric literals.
2. The diamond operator is an empty pair of angle brackets (<>) that serves as shorthand for specifying the actual type arguments when instantiating a generic type.
3. The answer is true: when multiple exception types are listed in a catch block's header, the parameter is implicitly regarded as `final`.
4. The statement that Java 7 uses to implement automatic resource management is `try-with-resources`.
5. A classloader is an object that dynamically loads compiled classes and other reference types (classes, for short) from classfiles, Java Archive (JAR) files, URLs, and other sources into memory.
6. A classloader's purpose is to insulate the virtual machine from filesystems, networks, and so on.
7. When the virtual machine starts running, the available classloaders are `bootstrap`, `extension`, and `system`.
8. The answer is false: the abstract `ClassLoader` class is the ultimate root class for all classloaders (including `extension` and `system`) except for `bootstrap`.
9. The `bootstrap` classloader is the root classloader.
10. The current classloader is the classloader that loads the class to which the currently executing method belongs.
11. The context classloader is the classloader associated with the current thread.
12. Central to `ClassLoader` are its `Class<?> loadClass(String name)` and protected `Class<?> loadClass(String name, boolean resolve)` methods, which try to load the class with the specified name.
13. The answer is true: context classloaders can be a source of difficulty. You'll either observe a thrown `ClassNotFoundException` instance or you may end up with the wrong version of a class.
14. You can use a classloader to load arbitrary resources (such as images). For example, `ClassLoader` declares an `InputStream getResourceAsStream(String name)` method for this purpose.
15. The `Console` class provides methods to access the character-based console device, if any, associated with the current virtual machine.

16. You obtain the console by calling the `System` class's `Console console()` class method and then testing the return value for null. If it isn't null, you have obtained the console.
17. The answer is false: `Console`'s `String readLine()` method reads a single line of text (not including line-termination characters) from the console's input stream.
18. A design pattern is a catalogued problem/solution entity that consists of a name, a problem statement, a solution, and a list of consequences.
19. The Strategy pattern lets you define a family of algorithms (such as sorting algorithms), encapsulate each algorithm in its own class, and make these algorithms interchangeable. Each encapsulated algorithm is known as a strategy. At runtime, your application chooses the appropriate algorithm that meets its requirements.
20. Double brace initialization is a special syntax for initializing a newly created object in a compact manner, for example, `new Office() {{addEmployee(new Employee("John Doe"));}};`
21. The two drawbacks of double brace initialization are a potential bloated number of classfiles and the inability to use Java 7's diamond operator when instantiating a generic type that's been subclassed by an anonymous class.
22. A fluent interface is an implementation of an object-oriented API that provides more readable code. It's normally implemented via method chaining to relay the instruction context of a subsequent method call. The context is defined through the return value of a called method, the context is self-referential in that the new context is equivalent to the last context, and the context is terminated through the return of a void context.
23. Five advantages that immutable classes have over mutable classes are as follows: objects created from immutable classes are thread-safe and there are no synchronization issues; you can share the internals of an immutable class to reduce memory usage and improve performance; immutable classes support failure atomicity, which means that, after throwing an exception, an object is still in a well-defined and usable state, even when the exception occurred during an operation; immutable classes are excellent building blocks for more complex classes; and immutable objects make good `Map` keys and `Set` elements because objects must not change state while in a collection.
24. Four guidelines for making a class immutable are as follows: don't include setter or other mutator methods in the class design, prevent methods from being overridden, declare all fields `final`, and prevent the class from exposing any mutable state.

25. Internationalization is the process of creating an application that automatically adapts to its current user's culture (without recompilation) so that the user can read text in the user's language and otherwise interact with the application without observing cultural biases.
26. Localization is the adaptation of internationalized software to support a new culture by adding culture-specific elements (such as text strings that have been translated to the culture).
27. A locale is a geographical, political, or cultural region.
28. Java provides the `Locale` class to represent a locale.
29. An expression for obtaining the Canadian locale is `new Locale("en", "CA")` or `Locale.CANADA`.
30. You can change the default locale that's made available to the virtual machine by assigning appropriate values to the `user.language` and `user.country` system properties (via the `-D` command-line option) when you launch the application via the `java` tool.
31. A resource bundle is a container that holds one or more locale-specific elements, and which are each associated with one and only one locale.
32. The answer is true: each resource bundle family shares a common base name.
33. An application loads its resource bundles by calling the various `getBundle()` class methods that are located in the abstract `ResourceBundle` class.
34. `MissingResourceException` is thrown when a resource bundle cannot be found after an exhaustive search.
35. A property resource bundle is a resource bundle backed by a properties file, which is a text file (with a `.properties` extension) that stores textual elements as a series of `key=value` entries. `PropertyResourceBundle`, a concrete subclass of `ResourceBundle`, manages property resource bundles.
36. A list resource bundle is a resource bundle backed by a classfile, which describes a concrete subclass of `ListResourceBundle` (an abstract subclass of `ResourceBundle`).
37. The answer is false: when a property resource bundle and a list resource bundle have the same complete resource bundle name, the list resource bundle takes precedence over the property resource bundle.
38. `ResourceBundle` provides the `void clearCache()` and `void clearCache(ClassLoader loader)` class methods that make it possible to design a server application that clears out all cached resource bundles upon command.

39. Java 6 reworked `ResourceBundle` to depend on a nested `Control` class because `ResourceBundle`'s `getBundle()` methods were previously hardwired to look for resource bundles, and resource bundlers were always cached. This lack of flexibility prevented you from performing tasks such as obtaining resource data from sources other than properties files and classfiles (such as an XML file or a database). The nested `Control` class provides several callback methods that are invoked during the resource bundle search-and-load process. By overriding specific callback methods, you can achieve the desired flexibility. When none of these methods are overridden, the `getBundle()` methods behave as they always have.
40. The `BreakIterator` class lets you detect text boundaries.
41. The `Collator` class lets you make reliable string comparisons, which is especially important for languages where the relative order of their characters doesn't correspond to the Unicode values of these characters.
42. A date is a recorded temporal moment, a time zone is a set of geographical regions that share a common number of hours relative to Greenwich Mean Time (GMT), and a calendar is a system of organizing the passage of time.
43. The `Date` class represents a date as a positive or negative milliseconds value that's relative to the Unix Epoch (January 1, 1970 GMT).
44. You obtain a calendar for the default locale that uses a specific time zone by invoking the `Calendar getInstance(TimeZone zone)` factory method.
45. The answer is false: `Calendar` declares a `Date getTime()` method that returns a calendar's time representation as a `Date` instance.
46. The `Format` subclass that lets you obtain formatters that format numbers as currencies, integers, numbers with decimal points, and percentages (and also to parse such values) is `NumberFormat`.
47. You would obtain a date formatter to format the time portion of a date in a particular style for the default locale by invoking the `DateFormat getTimeInstance(int style)` factory method.
48. The difference between a simple message and a compound message is as follows: a simple message consists of static (unchanging) text, whereas a compound message consists of static text and variable (changeable) data.
49. To format a simple message, you obtain its text from a resource bundle and then display this text to the user. For a compound message, you obtain a pattern (template) for the message from a property resource bundle, pass this pattern along with the variable data to a message formatter to create a simple message, and display this message's text.
50. Java provides the `MessageFormatter` class to format simple and compound messages.

51. The class that you should use to format a compound message that contains singular and plural words is `ChoiceFormat`.
52. The answer is true: the `Format` class declares `parseObject()` methods for parsing strings into objects.
53. The package associated with Java's Logging API is `java.util.logging`.
54. The `Logger` class is the entry-point into the Logging API.
55. The standard set of log level constants provided by the `Level` class are `SEVERE`, `WARNING`, `INFO`, `CONFIG`, `FINE`, `FINER`, and `FINEST`.
56. The answer is false: loggers default to outputting log records for severe, warning, and informational log levels only.
57. You obtain a logger by invoking one of `Logger`'s `getLogger()` or `getAnonymousLogger()` class methods.
58. You obtain a logger's nearest parent logger by invoking `Logger`'s `getLogger()` method.
59. The four categories of message-logging methods are `log()`, `logp()`, `logrb()`, and miscellaneous (such as `info()`).
60. The `entering()` and `exiting()` methods log messages at the `Level.FINER` log level.
61. You change a logger's log level by invoking `Logger`'s void `setLevel(Level newLevel)` method.
62. The `Filter` interface provides the boolean `isLoggable(LogRecord record)` method for further filtering log records regardless of their log levels.
63. You obtain the name of the method that's the source of a log record by invoking `LogRecord`'s `String getSourceMethodName()` method.
64. The logging framework sends a log record to its ultimate destination (such as the console) by invoking a concrete handler's overriding void `publish(LogRecord record)` method.
65. You obtain a logger's registered handlers by invoking `Logger`'s `Handler[] getHandlers()` method.
66. The answer is false: `FileHandler`'s default formatter is an instance of `XMLFormatter`.
67. The `LogManager` class manages a hierarchical namespace of all named `Logger` objects and maintains the configuration properties of the logging framework.
68. The Logging API's logging methods never throw exceptions; it would be burdensome to force developers to wrap all of their logging calls in try/catch constructs. Besides, how would the application recover from an exception

in the logging framework? Because Handler classes such as `FileHandler` and `StreamHandler` can experience I/O exceptions, the Logging API provides the `ErrorManager` class so that a handler can report an exception instead of discarding it.

69. The Preferences API lets you store preferences in a hierarchical manner so that you can avoid name collisions. Because this API is backend-neutral, it doesn't matter where the preferences are stored (a file, a database, or [on Windows platforms] the registry); you don't have to hardcode file names and locations. Also, there are no text files that can be modified, and Preferences can be used on diskless platforms.
70. The Preferences API manages preferences by using trees of nodes. These nodes are the analogue of a hierarchical filesystem's directories. Also, preference name/value pairs stored under these nodes are the analogues of a directory's files. You navigate these trees in a similar manner to navigating a filesystem: specify an absolute path starting from the root node (`/`) to the node of interest, such as `/window/location` and `/window/size`.
71. The difference between the system preference tree and the user preference tree is as follows: all users share the system preference tree, whereas the user preference tree is specific to a single user, which is generally the person who logged into the underlying platform.
72. The package assigned to the Preferences API is `java.util.prefs`. This package contains three interfaces (`NodeChangeListener`, `PreferencesChangeListener`, and `PreferencesFactory`), four regular classes (`AbstractPreferences`, `NodeChangeEvent`, `PreferenceChangeEvent`, and `Preferences`), and two exception classes (`BackingStoreException` and `InvalidPreferencesFormatException`).
73. The Preferences API's `Preferences` class is the entry point.
74. You obtain the root node of the system preference tree by invoking `Preferences`'s `Preferences` `systemRoot()` class method.
75. The `Runtime` class provides Java applications with access to their runtime environment. You obtain an instance of this class by invoking its `Runtime` `getRuntime()` class method.
76. `Runtime` provides several `exec()` methods for executing other applications. For example, `Process` `exec(String program)` executes the program named `program` in a separate native process. The new process inherits the environment of the method's caller, and a `Process` object is returned to allow communication with the new process. `IOException` is thrown when an I/O error occurs.

77. The Java Native Interface is a native programming interface that lets Java code running in a virtual machine interoperate with native libraries written in other languages (such as C, C++, or even assembly language). The JNI is a bridge between the virtual machine and the underlying platform to which the native libraries target.
78. A hybrid library is a combination of a Java class and a native interface library, which is a library that provides a native function counterpart for each declared native method, and it can communicate directly with platform-specific libraries.
79. The JNI throws `UnsatisfiedLinkError` when you try to load a nonexistent library.
80. The package for working with ZIP archives is `java.util.zip`.
81. Each stored file in a ZIP archive is known as a ZIP entry, which is represented by the `ZipEntry` class.
82. The answer is true: the name of a stored file in a ZIP archive cannot exceed 65,536 bytes.
83. `ZipOutputStream` writes ZIP entries (compressed as well as uncompressed) to a ZIP archive.
84. `ZipInputStream` reads ZIP entries (compressed as well as uncompressed) from a ZIP archive.
85. `ZipFile` appears to be an alias for `ZipInputStream`.
86. The package for working with JAR files is `java.util.jar`.
87. The manifest is a special file named `MANIFEST.MF` that stores information about the contents of the JAR file. This file is located in the JAR file's `META-INF` directory.
88. The answer is true: when creating a manifest for a JAR output stream, you must store `MANIFEST_VERSION`; otherwise, you'll observe a thrown exception at runtime.
89. Listing A-70 presents the `SpanishCollation` application that was called for in Chapter 16.

*Listing A-70. Outputting Spanish Words According to This Language's Current Collation Rules Followed by Its Traditional Collation Rules*

```
import java.text.Collator;
import java.text.ParseException;
import java.text.RuleBasedCollator;

import java.util.Arrays;
import java.util.Locale;
```

```

public class SpanishCollation
{
    public static void main(String[] args)
    {
        String[] words =
        {
            "ñango", // weak
            "llamado", // called
            "lunes", // monday
            "champán", // champagne
            "clamor", // outcry
            "cerca", // near
            "nombre", // name
            "chiste", // joke
        };
        Locale locale = new Locale("es", "");
        Collator c = Collator.getInstance(locale);
        Arrays.sort(words, c);
        for (String word: words)
            System.out.println(word);
        System.out.println();
        // Define the traditional Spanish sort rules.
        String upperNTilde = new String ("\u00D1");
        String lowerNTilde = new String ("\u00F1");
        String spanishRules = "< a,A < b,B < c,C < ch, cH, Ch, CH < d,D < e,E " +
            "< f,F < g,G < h,H < i,I < j,J < k,K < l,L < ll, " +
            "lL, Ll, LL < m,M < n,N < " + lowerNTilde + ", " +
            upperNTilde + " < o,O < p,P < q,Q < r,R < s,S < " +
            "t,T < u,U < v,V < w,W < x,X < y,Y < z,Z";

        try
        {
            c = new RuleBasedCollator(spanishRules);
            Arrays.sort(words, c);
            for (String word: words)
                System.out.println(word);
        }
        catch (ParseException pe)
        {
            System.err.println(pe);
        }
    }
}

```

Compile Listing A-70 as follows:

```
javac SpanishCollation.java
```

Run this application as follows:

```
java SpanishCollation
```



You should observe the following output:

---

```
cerca
champán
chiste
clamor
llamado
lunes
nombre
ñango
```

```
cerca
clamor
champán
chiste
lunes
llamado
nombre
ñango
```

---

90. Listing A-71 presents the ZipList application that was called for in Chapter 16.

*Listing A-71. Archive Contents*

```
import java.io.FileInputStream;
import java.io.IOException;

import java.util.Date;

import java.util.zip.ZipEntry;
import java.util.zip.ZipInputStream;

public class ZipList
{
    public static void main(String[] args) throws IOException
    {
        if (args.length != 1)
        {
            System.err.println("usage: java ZipList zipfile");
            return;
        }
        ZipInputStream zis = null;
        try
        {
            zis = new ZipInputStream(new FileInputStream(args[0]));
            ZipEntry ze;
```

```
while ((ze = zis.getNextEntry()) != null)
{
    System.out.println(ze.getName());
    System.out.println("  Compressed Size: " + ze.getCompressedSize());
    System.out.println("  Uncompressed Size: " + ze.getSize());
    if (ze.getTime() != -1)
        System.out.println("    Modification Time: " + new Date(ze.getTime()));
    System.out.println();
    zis.closeEntry();
}
}
catch (IOException ioe)
{
    System.err.println("I/O error: " + ioe.getMessage());
}
finally
{
    if (zis != null)
        try
        {
            zis.close();
        }
        catch (IOException ioe)
        {
            assert false; // shouldn't happen in this context
        }
}
}
```

# Four of a Kind

Application development isn't an easy task. If you don't plan carefully before you develop an application, you'll probably waste your time and money as you endeavour to create it, and waste your users' time and money when it doesn't meet their needs.

**Caution** It's extremely important to test your software carefully. You could face a lawsuit if malfunctioning software causes financial harm to its users.

In this appendix, I present one technique for developing applications efficiently. I present this technique in the context of a Java application that lets you play a simple card game called *Four of a Kind* against the computer.

## Understanding Four of a Kind

Before sitting down at the computer and writing code, you need to fully understand the problem domain that you are trying to model via that code. In this case, the problem domain is *Four of a Kind*, and you want to understand how this card game works.

Two to four players play *Four of a Kind* with a standard 52-card deck. The object of the game is to be the first player to put down four cards that have the same rank (four aces, for example), which wins the game.

The game begins by shuffling the deck and placing it face down. Each player takes a card from the top of the deck. The player with the highest ranked card (king is highest) deals four cards to each player, starting with the player to the dealer's left. The dealer then starts its turn.

The player examines her cards to determine which cards are optimal for achieving four of a kind. The player then throws away the least helpful card on a discard pile and picks up another card from the top of the deck. (If each card has a different rank, the player randomly selects a card to throw away.) If the player has four of a kind, the player puts down these cards (face up) and wins the game.

## Modeling Four of a Kind in Pseudocode

Now that you understand how *Four of a Kind* works, you can begin to model this game. You will not model the game in Java source code because you would get bogged down in too many details. Instead, you will use pseudocode for this task.

*Pseudocode* is a compact and informal high-level description of the problem domain. Unlike the previous description of *Four of a Kind*, the pseudocode equivalent is a step-by-step recipe for solving the problem. Check out Listing B-1.

### Listing B-1. *Four of a Kind Pseudocode for Two Players (Human and Computer)*

1. Create a deck of cards and shuffle the deck.
2. Create empty discard pile.
3. Have each of the human and computer players take a card from the top of the deck.
4. Designate the player with the highest ranked card as the current player.
5. Return both cards to the bottom of the deck.
6. The current player deals four cards to each of the two players in alternating fashion, with the first card being dealt to the other player.
7. The current player examines its current cards to see which cards are optimal for achieving four of a kind. The current player throws the least helpful card onto the top of the discard pile.
8. The current player picks up the deck's top card. If the current player has four of a kind, it puts down its cards and wins the game.
9. Designate the other player as the current player.
10. If the deck has no more cards, empty the discard pile to the deck and shuffle the deck.
11. Repeat at step 7.

Deriving Listing B-1's pseudocode from the previous description is the first step in achieving an application that implements *Four of a Kind*. This pseudocode performs various tasks including decision making and repetition.

Despite being a more useful guide to understanding how *Four of a Kind* works, Listing B-1 is too high level for translation to Java. Therefore, you must refine this pseudocode to facilitate the translation process. Listing B-2 presents this refinement.

### Listing B-2. *Refined Four of a Kind Pseudocode for Two Players (Human and Computer)*

1. deck = new Deck()
2. deck.shuffle()
3. discardPile = new DiscardPile()
4. hCard = deck.deal()
5. cCard = deck.deal()
6. if hCard.rank() == cCard.rank()
  - 6.1. deck.putBack(hCard)
  - 6.2. deck.putBack(cCard)
  - 6.3. deck.shuffle()
  - 6.4. Repeat at step 4
7. curPlayer = HUMAN
  - 7.1. if cCard.rank() > hCard.rank()
    - 7.1.1. curPlayer = COMPUTER
8. deck.putBack(hCard)
9. deck.putBack(cCard)

```

10. if curPlayer == HUMAN
    10.1. for i = 0 to 3
        10.1.1. cCards[i] = deck.deal()
        10.1.2. hCards[i] = deck.deal()
    else
    10.2. for i = 0 to 3
        10.2.1. hCards[i] = deck.deal()
        10.2.2. cCards[i] = deck.deal()
11. if curPlayer == HUMAN
    11.01. output(hCards)
    11.02. choice = prompt("Identify card to throw away")
    11.03. discardPile.setTopCard(hCards[choice])
    11.04. hCards[choice] = deck.deal()
    11.05. if isFourOfAKind(hCards)
        11.05.1. output("Human wins!")
        11.05.2. putDown(hCards)
        11.05.3. output("Computer's cards:")
        11.05.4. putDown(cCards)
        11.05.5. End game
    11.06. curPlayer = COMPUTER
    else
    11.07. choice = leastDesirableCard(cCards)
    11.08. discardPile.setTopCard(cCards[choice])
    11.09. cCards[choice] = deck.deal()
    11.10. if isFourOfAKind(cCards)
        11.10.1. output("Computer wins!")
        11.10.2. putDown(cCards)
        11.10.3. End game
    11.11. curPlayer = HUMAN
12. if deck.isEmpty()
    12.1. if discardPile.topCard() != null
        12.1.1. deck.putBack(discardPile.getTopCard())
        12.1.2. Repeat at step 12.1.
    12.2. deck.shuffle()
13. Repeat at step 11.

```

In addition to being longer than Listing B-1, Listing B-2 shows the refined pseudocode becoming more like Java. For example, Listing B-2 reveals Java expressions (such as `new Deck()`, to create a Deck object), operators (such as `==`, to compare two values for equality), and method calls (such as `deck.isEmpty()`, to call `deck`'s `isEmpty()` method to return a Boolean value indicating whether [true] or not [false] the deck identified by `deck` is empty of cards).

## Converting Pseudocode to Java Code

Now that you've had a chance to absorb Listing B-2's Java-like pseudocode, you're ready to examine the process of converting that pseudocode to Java source code. This process consists of a couple of steps.

The first step in converting Listing B-2's pseudocode to Java involves identifying important components of the game's structure and implementing these components as classes, which I formally introduced in Chapter 3.

Apart from the computer player (which is implemented via game logic), the important components are card, deck, and discard pile. I represent these components via Card, Deck, and DiscardPile classes. Listing B-3 presents Card.

*Listing B-3. Merging Suits and Ranks into Cards*

```
/**
 * Simulating a playing card.
 *
 * @author Jeff Friesen
 */

public enum Card
{
    ACE_OF_CLUBS(Suit.CLUBS, Rank.ACE),
    TWO_OF_CLUBS(Suit.CLUBS, Rank.TWO),
    THREE_OF_CLUBS(Suit.CLUBS, Rank.THREE),
    FOUR_OF_CLUBS(Suit.CLUBS, Rank.FOUR),
    FIVE_OF_CLUBS(Suit.CLUBS, Rank.FIVE),
    SIX_OF_CLUBS(Suit.CLUBS, Rank.SIX),
    SEVEN_OF_CLUBS(Suit.CLUBS, Rank.SEVEN),
    EIGHT_OF_CLUBS(Suit.CLUBS, Rank.EIGHT),
    NINE_OF_CLUBS(Suit.CLUBS, Rank.NINE),
    TEN_OF_CLUBS(Suit.CLUBS, Rank.TEN),
    JACK_OF_CLUBS(Suit.CLUBS, Rank.JACK),
    QUEEN_OF_CLUBS(Suit.CLUBS, Rank.QUEEN),
    KING_OF_CLUBS(Suit.CLUBS, Rank.KING),
    ACE_OF_DIAMONDS(Suit.DIAMONDS, Rank.ACE),
    TWO_OF_DIAMONDS(Suit.DIAMONDS, Rank.TWO),
    THREE_OF_DIAMONDS(Suit.DIAMONDS, Rank.THREE),
    FOUR_OF_DIAMONDS(Suit.DIAMONDS, Rank.FOUR),
    FIVE_OF_DIAMONDS(Suit.DIAMONDS, Rank.FIVE),
    SIX_OF_DIAMONDS(Suit.DIAMONDS, Rank.SIX),
    SEVEN_OF_DIAMONDS(Suit.DIAMONDS, Rank.SEVEN),
    EIGHT_OF_DIAMONDS(Suit.DIAMONDS, Rank.EIGHT),
    NINE_OF_DIAMONDS(Suit.DIAMONDS, Rank.NINE),
    TEN_OF_DIAMONDS(Suit.DIAMONDS, Rank.TEN),
    JACK_OF_DIAMONDS(Suit.DIAMONDS, Rank.JACK),
    QUEEN_OF_DIAMONDS(Suit.DIAMONDS, Rank.QUEEN),
    KING_OF_DIAMONDS(Suit.DIAMONDS, Rank.KING),
    ACE_OF_HEARTS(Suit.HEARTS, Rank.ACE),
    TWO_OF_HEARTS(Suit.HEARTS, Rank.TWO),
    THREE_OF_HEARTS(Suit.HEARTS, Rank.THREE),
    FOUR_OF_HEARTS(Suit.HEARTS, Rank.FOUR),
    FIVE_OF_HEARTS(Suit.HEARTS, Rank.FIVE),
    SIX_OF_HEARTS(Suit.HEARTS, Rank.SIX),
    SEVEN_OF_HEARTS(Suit.HEARTS, Rank.SEVEN),
    EIGHT_OF_HEARTS(Suit.HEARTS, Rank.EIGHT),
    NINE_OF_HEARTS(Suit.HEARTS, Rank.NINE),
    TEN_OF_HEARTS(Suit.HEARTS, Rank.TEN),
    JACK_OF_HEARTS(Suit.HEARTS, Rank.JACK),
    QUEEN_OF_HEARTS(Suit.HEARTS, Rank.QUEEN),
```

```

KING_OF_HEARTS(Suit.HEARTS, Rank.KING),
ACE_OF_SPADES(Suit.SPADES, Rank.ACE),
TWO_OF_SPADES(Suit.SPADES, Rank.TWO),
THREE_OF_SPADES(Suit.SPADES, Rank.THREE),
FOUR_OF_SPADES(Suit.SPADES, Rank.FOUR),
FIVE_OF_SPADES(Suit.SPADES, Rank.FIVE),
SIX_OF_SPADES(Suit.SPADES, Rank.SIX),
SEVEN_OF_SPADES(Suit.SPADES, Rank.SEVEN),
EIGHT_OF_SPADES(Suit.SPADES, Rank.EIGHT),
NINE_OF_SPADES(Suit.SPADES, Rank.NINE),
TEN_OF_SPADES(Suit.SPADES, Rank.TEN),
JACK_OF_SPADES(Suit.SPADES, Rank.JACK),
QUEEN_OF_SPADES(Suit.SPADES, Rank.QUEEN),
KING_OF_SPADES(Suit.SPADES, Rank.KING);

private Suit suit;

/**
 * Return <code>Card</code>'s suit.
 *
 * @return <code>CLUBS</code>, <code>DIAMONDS</code>, <code>HEARTS</code>,
 * or <code>SPADES</code>
 */

public Suit suit()
{
    return suit;
}

private Rank rank;

/**
 * Return <code>Card</code>'s rank.
 *
 * @return <code>ACE</code>, <code>TWO</code>, <code>THREE</code>,
 * <code>FOUR</code>, <code>FIVE</code>, <code>SIX</code>,
 * <code>SEVEN</code>, <code>EIGHT</code>, <code>NINE</code>,
 * <code>TEN</code>, <code>JACK</code>, <code>QUEEN</code>,
 * <code>KING</code>.
 */

public Rank rank()
{
    return rank;
}

Card(Suit suit, Rank rank)
{
    this.suit = suit;
    this.rank = rank;
}

```

```

/**
 * A card's suit is its membership.
 *
 * @author Jeff Friesen
 */

public enum Suit
{
    CLUBS, DIAMONDS, HEARTS, SPADES
}

/**
 * A card's rank is its integer value.
 *
 * @author Jeff Friesen
 */

public enum Rank
{
    ACE, TWO, THREE, FOUR, FIVE, SIX, SEVEN, EIGHT, NINE, TEN, JACK, QUEEN,
    KING
}
}

```

Listing B-3 begins with a Javadoc comment that's used to briefly describe the subsequently declared `Card` class and identify this class's author. (I briefly introduced Javadoc comments in Chapter 2.)

**Note** One feature of Javadoc comments is the ability to embed HTML tags. These tags specify different kinds of formatting for sections of text within these comments. For example, `<code>` and `</code>` (and `<pre>` and `</pre>`) specify that their enclosed text is to be formatted as a code listing. Later in this appendix, you'll learn how to convert these comments into HTML documentation.

`Card` is an example of an *enum*, which is a special kind of class that I discussed in Chapter 6. If you haven't read that chapter, think of `Card` as a place to create and store `Card` objects that identify all 52 cards that make up a standard deck.

`Card` declares a nested `Suit` enum. (I discussed nesting in Chapter 5.) A card's suit denotes its membership. The only legal `Suit` values are `CLUBS`, `DIAMONDS`, `HEARTS`, and `SPADES`.

`Card` also declares a nested `Rank` enum. A card's rank denotes its value: `ACE`, `TWO`, `THREE`, `FOUR`, `FIVE`, `SIX`, `SEVEN`, `EIGHT`, `NINE`, `TEN`, `JACK`, `QUEEN`, and `KING` are the only legal `Rank` values.

A `Card` object is created when `Suit` and `Rank` objects are passed to its constructor. (I discussed constructors in Chapter 3.) For example, `KING_OF_HEARTS(Suit.HEARTS, Rank.KING)` combines `Suit.HEARTS` and `Rank.KING` into `KING_OF_HEARTS`.

`Card` provides a `rank()` method for returning a `Card`'s `Rank` object. Similarly, `Card` provides a `suit()` method for returning a `Card`'s `Suit` object. For example, `KING_OF_HEARTS.rank()` returns `Rank.KING`, and `KING_OF_HEARTS.suit()` returns `Suit.HEARTS`.



Listing B-4 presents the Java source code to the Deck class, which implements a deck of 52 cards

*Listing B-4. Pick a Card, Any Card*

```
import java.util.ArrayList;
import java.util.Collections;
import java.util.List;

/**
 * Simulate a deck of cards.
 *
 * @author Jeff Friesen
 */

public class Deck
{
    private Card[] cards = new Card[]
    {
        Card.ACE_OF_CLUBS,
        Card.TWO_OF_CLUBS,
        Card.THREE_OF_CLUBS,
        Card.FOUR_OF_CLUBS,
        Card.FIVE_OF_CLUBS,
        Card.SIX_OF_CLUBS,
        Card.SEVEN_OF_CLUBS,
        Card.EIGHT_OF_CLUBS,
        Card.NINE_OF_CLUBS,
        Card.TEN_OF_CLUBS,
        Card.JACK_OF_CLUBS,
        Card.QUEEN_OF_CLUBS,
        Card.KING_OF_CLUBS,
        Card.ACE_OF_DIAMONDS,
        Card.TWO_OF_DIAMONDS,
        Card.THREE_OF_DIAMONDS,
        Card.FOUR_OF_DIAMONDS,
        Card.FIVE_OF_DIAMONDS,
        Card.SIX_OF_DIAMONDS,
        Card.SEVEN_OF_DIAMONDS,
        Card.EIGHT_OF_DIAMONDS,
        Card.NINE_OF_DIAMONDS,
        Card.TEN_OF_DIAMONDS,
        Card.JACK_OF_DIAMONDS,
        Card.QUEEN_OF_DIAMONDS,
        Card.KING_OF_DIAMONDS,
        Card.ACE_OF_HEARTS,
        Card.TWO_OF_HEARTS,
        Card.THREE_OF_HEARTS,
        Card.FOUR_OF_HEARTS,
        Card.FIVE_OF_HEARTS,
        Card.SIX_OF_HEARTS,
        Card.SEVEN_OF_HEARTS,
        Card.EIGHT_OF_HEARTS,
```

```
Card.NINE_OF_HEARTS,
Card.TEN_OF_HEARTS,
Card.JACK_OF_HEARTS,
Card.QUEEN_OF_HEARTS,
Card.KING_OF_HEARTS,
Card.ACE_OF_SPADES,
Card.TWO_OF_SPADES,
Card.THREE_OF_SPADES,
Card.FOUR_OF_SPADES,
Card.FIVE_OF_SPADES,
Card.SIX_OF_SPADES,
Card.SEVEN_OF_SPADES,
Card.EIGHT_OF_SPADES,
Card.NINE_OF_SPADES,
Card.TEN_OF_SPADES,
Card.JACK_OF_SPADES,
Card.QUEEN_OF_SPADES,
Card.KING_OF_SPADES
};

private List<Card> deck;

/**
 * Create a <code>Deck</code> of 52 <code>Card</code> objects. Shuffle
 * these objects.
 */

public Deck()
{
    deck = new ArrayList<Card>();
    for (int i = 0; i < cards.length; i++)
    {
        deck.add(cards[i]);
        cards[i] = null;
    }
    Collections.shuffle(deck);
}

/**
 * Deal the <code>Deck</code>'s top <code>Card</code> object.
 *
 * @return the <code>Card</code> object at the top of the
 * <code>Deck</code>
 */

public Card deal()
{
    return deck.remove(0);
}
```

```

/**
 * Return an indicator of whether or not the <code>Deck</code> is empty.
 *
 * @return true if the <code>Deck</code> contains no <code>Card</code>
 * objects; otherwise, false
 */

public boolean isEmpty()
{
    return deck.isEmpty();
}

/**
 * Put back a <code>Card</code> at the bottom of the <code>Deck</code>.
 *
 * @param card <code>Card</code> object being put back
 */

public void putBack(Card card)
{
    deck.add(card);
}

/**
 * Shuffle the <code>Deck</code>.
 */

public void shuffle()
{
    Collections.shuffle(deck);
}
}

```

Deck initializes a private cards array to all 52 Card objects. Because it's easier to implement Deck via a list that stores these objects, Deck's constructor creates this list and adds each Card object to the list. (I discussed List and ArrayList in Chapter 9.)

Deck also provides deal(), isEmpty(), putBack(), and shuffle() methods to deal a single Card from the Deck (the Card is physically removed from the Deck), determine whether or not the Deck is empty, put a Card back into the Deck, and shuffle the Deck's Cards.

Listing B-5 presents the source code to the DiscardPile class, which implements a discard pile on which players can throw away a maximum of 52 cards.

**Listing B-5. A Garbage Dump for Cards**

```

import java.util.ArrayList;
import java.util.List;

/**
 * Simulate a pile of discarded cards.
 *
 * @author Jeff Friesen
 */

```

```
public class DiscardPile
{
    private Card[] cards;
    private int top;

    /**
     * Create a <code>DiscardPile</code> that can accommodate a maximum of 52
     * <code>Card</code>s. The <code>DiscardPile</code> is initially empty.
     */

    public DiscardPile()
    {
        cards = new Card[52]; // Room for entire deck on discard pile (should
                               // never happen).
        top = -1;
    }

    /**
     * Return the <code>Card</code> at the top of the <code>DiscardPile</code>.
     *
     * @return <code>Card</code> object at top of <code>DiscardPile</code> or
     * null if <code>DiscardPile</code> is empty
     */

    public Card getTopCard()
    {
        if (top == -1)
            return null;
        Card card = cards[top];
        cards[top--] = null;
        return card;
    }

    /**
     * Set the <code>DiscardPile</code>'s top card to the specified
     * <code>Card</code> object.
     *
     * @param card <code>Card</code> object being thrown on top of the
     * <code>DiscardPile</code>
     */

    public void setTopCard(Card card)
    {
        cards[++top] = card;
    }
}
```

```

/**
 * Identify the top <code>Card</code> on the <code>DiscardPile</code>
 * without removing this <code>Card</code>.
 *
 * @return top <code>Card</code>, or null if <code>DiscardPile</code> is
 * empty
 */

public Card topCard()
{
    return (top == -1) ? null : cards[top];
}
}

```

`DiscardPile` implements a discard pile on which to throw `Card` objects. It implements the discard pile via a stack metaphor: the last `Card` object thrown on the pile sits at the top of the pile and is the first `Card` object to be removed from the pile.

This class stores its stack of `Card` objects in a private `cards` array. I found it convenient to specify 52 as this array's storage limit because the maximum number of `Cards` is 52. (Game play will never result in all `Cards` being stored in the array.)

Along with its constructor, `DiscardPile` provides `getTopCard()`, `setTopCard()`, and `topCard()` methods to remove and return the stack's top `Card`, store a new `Card` object on the stack as its top `Card`, and return the top `Card` without removing it from the stack.

The constructor demonstrates a single-line comment, which starts with the `//` character sequence. This comment documents that the `cards` array has room to store the entire Deck of `Cards`. I formally introduced single-line comments in Chapter 2.

The second step in converting Listing B-2's pseudocode to Java involves introducing a `FourOfAKind` class whose `main()` method contains the Java code equivalent of this pseudocode. Listing B-6 presents `FourOfAKind`.

**Listing B-6. *FourOfAKind Application Source Code***

```

/**
 * <code>FourOfAKind</code> implements a card game that is played between two
 * players: one human player and the computer. You play this game with a
 * standard 52-card deck and attempt to beat the computer by being the first
 * player to put down four cards that have the same rank (four aces, for
 * example), and win.
 *
 * <p>
 * The game begins by shuffling the deck and placing it face down. Each
 * player takes a card from the top of the deck. The player with the highest
 * ranked card (king is highest) deals four cards to each player starting
 * with the other player. The dealer then starts its turn.
 *
 */

```

```
* <p>
* The player examines its cards to determine which cards are optimal for
* achieving four of a kind. The player then throws away one card on a
* discard pile and picks up another card from the top of the deck. If the
* player has four of a kind, the player puts down these cards (face up) and
* wins the game.
*
* @author Jeff Friesen
* @version 1.0
*/

public class FourOfAKind
{
    /**
     * Human player
     */

    final static int HUMAN = 0;

    /**
     * Computer player
     */

    final static int COMPUTER = 1;

    /**
     * Application entry point.
     *
     * @param args array of command-line arguments passed to this method
     */

    public static void main(String[] args)
    {
        System.out.println("Welcome to Four of a Kind!");
        Deck deck = new Deck(); // Deck automatically shuffled
        DiscardPile discardPile = new DiscardPile();
        Card hCard;
        Card cCard;
        while (true)
        {
            hCard = deck.deal();
            cCard = deck.deal();
            if (hCard.rank() != cCard.rank())
                break;
            deck.putBack(hCard);
            deck.putBack(cCard);
            deck.shuffle(); // prevent pathological case where every successive
        } // pair of cards have the same rank
        int curPlayer = HUMAN;
        if (cCard.rank().ordinal() > hCard.rank().ordinal())
            curPlayer = COMPUTER;
        deck.putBack(hCard);
    }
}
```

```

hCard = null;
deck.putBack(cCard);
cCard = null;
Card[] hCards = new Card[4];
Card[] cCards = new Card[4];
if (curPlayer == HUMAN)
    for (int i = 0; i < 4; i++)
    {
        cCards[i] = deck.deal();
        hCards[i] = deck.deal();
    }
else
    for (int i = 0; i < 4; i++)
    {
        hCards[i] = deck.deal();
        cCards[i] = deck.deal();
    }
while (true)
{
    if (curPlayer == HUMAN)
    {
        showHeldCards(hCards);
        int choice = 0;
        while (choice < 'A' || choice > 'D')
        {
            choice = prompt("Which card do you want to throw away (A, B, " +
                "C, D)? ");
            switch (choice)
            {
                case 'a': choice = 'A'; break;
                case 'b': choice = 'B'; break;
                case 'c': choice = 'C'; break;
                case 'd': choice = 'D';
            }
        }
        discardPile.setTopCard(hCards[choice - 'A']);
        hCards[choice - 'A'] = deck.deal();
        if (isFourOfAKind(hCards))
        {
            System.out.println();
            System.out.println("Human wins!");
            System.out.println();
            putDown("Human's cards:", hCards);
            System.out.println();
            putDown("Computer's cards:", cCards);
            return; // Exit application by returning from main()
        }
        curPlayer = COMPUTER;
    }
    else

```

```

    {
        int choice = leastDesirableCard(cCards);
        discardPile.setTopCard(cCards[choice]);
        cCards[choice] = deck.deal();
        if (isFourOfAKind(cCards))
        {
            System.out.println();
            System.out.println("Computer wins!");
            System.out.println();
            putDown("Computer's cards:", cCards);
            return; // Exit application by returning from main()
        }
        curPlayer = HUMAN;
    }
    if (deck.isEmpty())
    {
        while (discardPile.topCard() != null)
            deck.putBack(discardPile.getTopCard());
        deck.shuffle();
    }
}

/**
 * Determine if the <code>Card</code> objects passed to this method all
 * have the same rank.
 *
 * @param cards array of <code>Card</code> objects passed to this method
 *
 * @return true if all <code>Card</code> objects have the same rank;
 * otherwise, false
 */

static boolean isFourOfAKind(Card[] cards)
{
    for (int i = 1; i < cards.length; i++)
        if (cards[i].rank() != cards[0].rank())
            return false;
    return true;
}

/**
 * Identify one of the <code>Card</code> objects that is passed to this
 * method as the least desirable <code>Card</code> object to hold onto.
 *
 * @param cards array of <code>Card</code> objects passed to this method
 *
 * @return 0-based rank (ace is 0, king is 13) of least desirable card
 */

```



```

static int leastDesirableCard(Card[] cards)
{
    int[] rankCounts = new int[13];
    for (int i = 0; i < cards.length; i++)
        rankCounts[cards[i].rank().ordinal()]++;
    int minCount = Integer.MAX_VALUE;
    int minIndex = -1;
    for (int i = 0; i < rankCounts.length; i++)
        if (rankCounts[i] < minCount && rankCounts[i] != 0)
        {
            minCount = rankCounts[i];
            minIndex = i;
        }
    for (int i = 0; i < cards.length; i++)
        if (cards[i].rank().ordinal() == minIndex)
            return i;
    return 0; // Needed to satisfy compiler (should never be executed)
}

/**
 * Prompt the human player to enter a character.
 *
 * @param msg message to be displayed to human player
 *
 * @return integer value of character entered by user.
 */

static int prompt(String msg)
{
    System.out.print(msg);
    try
    {
        int ch = System.in.read();
        // Erase all subsequent characters including terminating \n newline
        // so that they do not affect a subsequent call to prompt().
        while (System.in.read() != '\n');
        return ch;
    }
    catch (java.io.IOException ioe)
    {
    }
    return 0;
}

/**
 * Display a message followed by all cards held by player. This output
 * simulates putting down held cards.
 *
 * @param msg message to be displayed to human player
 * @param cards array of Card objects to be identified
 */

```

```

static void putDown(String msg, Card[] cards)
{
    System.out.println(msg);
    for (int i = 0; i < cards.length; i++)
        System.out.println(cards[i]);
}

/**
 * Identify the cards being held via their <code>Card</code> objects on
 * separate lines. Prefix each line with an uppercase letter starting with
 * <code>A</code>.
 *
 * @param cards array of <code>Card</code> objects to be identified
 */

static void showHeldCards(Card[] cards)
{
    System.out.println();
    System.out.println("Held cards:");
    for (int i = 0; i < cards.length; i++)
        if (cards[i] != null)
            System.out.println((char) ('A' + i) + ". " + cards[i]);
    System.out.println();
}
}

```

Listing B-6 follows the steps outlined by and expands on Listing B-2's pseudocode. Because of the various comments, I don't have much to say about this listing. However, there are a couple of items that deserve mention:

- Card's nested Rank enum stores a sequence of 13 Rank objects beginning with ACE and ending with KING. These objects cannot be compared directly via > to determine which object has the greater rank. However, their integer-based ordinal (positional) values can be compared by calling the Rank object's ordinal() method. For example, Card.ACE\_OF\_SPADES.rank().ordinal() returns 0 because ACE is located at position 0 within Rank's list of Rank objects, and Card.KING\_OF\_CLUBS.rank().ordinal() returns 12 because KING is located at the last position in this list.
- The leastDesirableCard() method counts the ranks of the Cards in the array of four Card objects passed to this method and stores these counts in a rankCounts array. For example, given two of clubs, ace of spades, three of clubs, and ace of diamonds in the array passed to this method, rankCounts identifies one two, two aces, and one three. This method then searches rankCounts from smallest index (representing ace) to largest index (representing king) for the first smallest nonzero count (there might be a tie, as in one two and one three)—a zero count represents no Cards having that rank in the array of Card objects. Finally, the method searches the array of Card objects to identify the object whose rank ordinal matches the index of the smallest nonzero count and returns the index of this Card object. This behavior implies that the least desirable card is always the smallest ranked card. For example, given two of spades, three of diamonds, five of spades, and nine of clubs, two of spades is least desirable because it has the smallest rank.

Also, when there are multiple cards of the same rank, and when this rank is smaller than the rank of any other card in the array, this method will choose the first (in a left-to-right manner) of the multiple cards having the same rank as the least desirable card. For example, given (in this order) two of spades, two of hearts, three of diamonds, and jack of hearts, two of spades is least desirable because it's the first card with the smallest rank. However, when the rank of the multiple cards isn't the smallest, another card with the smallest rank is chosen as least desirable.

The JDK provides a javadoc tool that extracts all Javadoc comments from one or more source files and generates a set of HTML files containing this documentation in an easy-to-read format. These files serve as the program's documentation.

For example, suppose that the current directory contains `Card.java`, `Deck.java`, `DiscardPile.java`, and `FourOfAKind.java`. To generate HTML based on the Javadoc comments that appear in these files, specify the following command:

```
javadoc *.java
```

The javadoc tool responds by outputting the following messages:

```
Loading source file Card.java...
Loading source file Deck.java...
Loading source file DiscardPile.java...
Loading source file FourOfAKind.java...
Constructing Javadoc information...
Standard Doclet version 1.7.0_06
Building tree for all the packages and classes...
Generating \Card.html...
Generating \Card.Rank.html...
Generating \Card.Suit.html...
Generating \Deck.html...
Generating \DiscardPile.html...
Generating \FourOfAKind.html...
Generating \package-frame.html...
Generating \package-summary.html...
Generating \package-tree.html...
Generating \constant-values.html...
Building index for all the packages and classes...
Generating \overview-tree.html...
Generating \index-all.html...
Generating \deprecated-list.html...
Building index for all classes...
Generating \allclasses-frame.html...
Generating \allclasses-noframe.html...
Generating \index.html...
Generating \help-doc.html...
```

Furthermore, it generates a series of files, including the `index.html` entry-point file. If you point your web browser to this file, you should see a page that is similar to the page shown in Figure B-1.

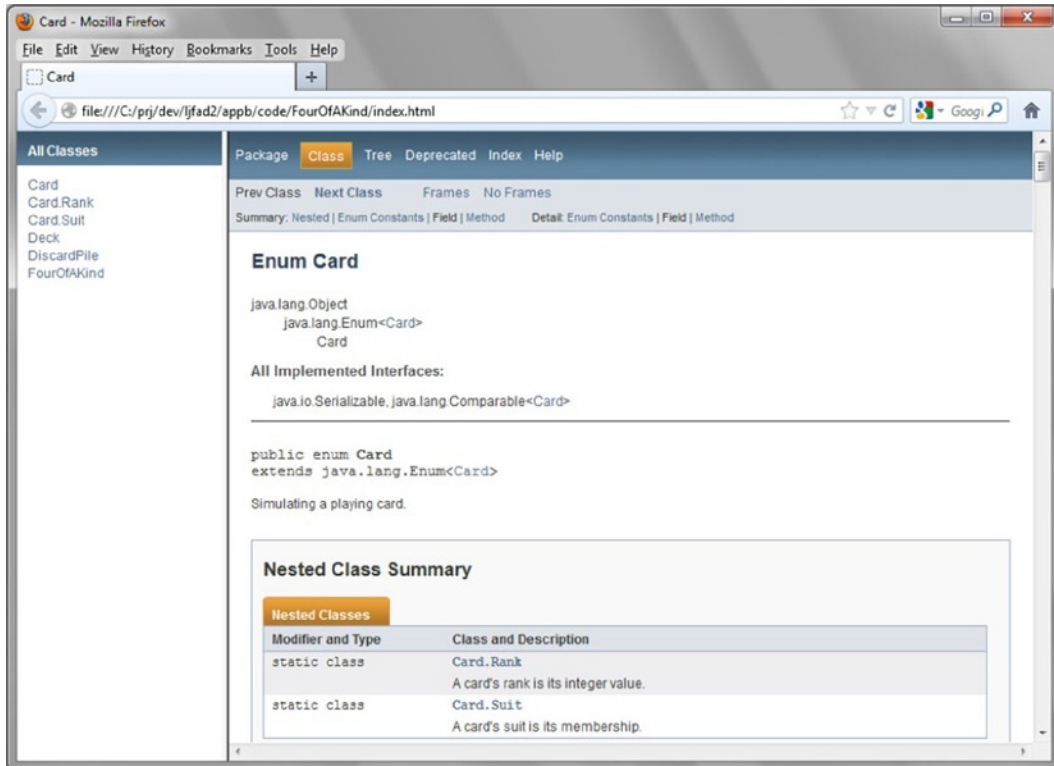

**Figure B-1.** Viewing the entry-point page in the generated Javadoc for `FourOfAKind` and supporting classes

Note that javadoc defaults to generating HTML-based documentation for public classes and public/protected members of classes. You learned about public classes and public/protected members of classes in Chapter 3.

For this reason, `FourOfAKind`'s documentation reveals only the public `main()` method. It doesn't reveal `isFourOfAKind()` and the other package-private methods. If you want to include these methods in the documentation, you must specify `-package` with javadoc:

```
javadoc -package *.java
```

**Note** The standard class library's documentation from Oracle was also generated by javadoc and adheres to the same format.

## Compiling, Running, and Distributing FourOfAKind

Unlike Chapter 1's `DumpArgs` and `EchoText` applications, which each consist of one source file, `FourOfAKind` consists of `Card.java`, `Deck.java`, `DiscardPile.java`, and `FourOfAKind.java`. You can compile all four source files via the following command line:

```
javac FourOfAKind.java
```

The `javac` tool launches the Java compiler, which recursively compiles the source files of the various classes it encounters during compilation. Assuming successful compilation, you should end up with six classfiles in the current directory.

**Tip** You can compile all Java source files in the current directory by specifying `javac *.java`.

After successfully compiling `FourOfAKind.java` and the other three source files, specify the following command line to run this application:

```
java FourOfAKind
```

In response, you see an introductory message and the four cards that you are holding. The following output reveals a single session:

```
Welcome to Four of a Kind!
```

```
Held cards:
```

- A. SIX\_OF\_CLUBS
- B. QUEEN\_OF\_DIAMONDS
- C. SIX\_OF\_HEARTS
- D. SIX\_OF\_SPADES

```
Which card do you want to throw away (A, B, C, D)? B
```

```
Held cards:
```

- A. SIX\_OF\_CLUBS
- B. NINE\_OF\_HEARTS
- C. SIX\_OF\_HEARTS
- D. SIX\_OF\_SPADES

```
Which card do you want to throw away (A, B, C, D)? B
```

```
Held cards:
```

- A. SIX\_OF\_CLUBS
- B. FOUR\_OF\_DIAMONDS
- C. SIX\_OF\_HEARTS
- D. SIX\_OF\_SPADES

Which card do you want to throw away (A, B, C, D)? B

Held cards:

- A. SIX\_OF\_CLUBS
- B. KING\_OF\_HEARTS
- C. SIX\_OF\_HEARTS
- D. SIX\_OF\_SPADES

Which card do you want to throw away (A, B, C, D)? B

Held cards:

- A. SIX\_OF\_CLUBS
- B. QUEEN\_OF\_CLUBS
- C. SIX\_OF\_HEARTS
- D. SIX\_OF\_SPADES

Which card do you want to throw away (A, B, C, D)? B

Held cards:

- A. SIX\_OF\_CLUBS
- B. KING\_OF\_DIAMONDS
- C. SIX\_OF\_HEARTS
- D. SIX\_OF\_SPADES

Which card do you want to throw away (A, B, C, D)? B

Held cards:

- A. SIX\_OF\_CLUBS
- B. TWO\_OF\_HEARTS
- C. SIX\_OF\_HEARTS
- D. SIX\_OF\_SPADES

Which card do you want to throw away (A, B, C, D)? B

Held cards:

- A. SIX\_OF\_CLUBS
- B. FIVE\_OF\_DIAMONDS
- C. SIX\_OF\_HEARTS
- D. SIX\_OF\_SPADES

Which card do you want to throw away (A, B, C, D)? B

Held cards:

- A. SIX\_OF\_CLUBS
- B. JACK\_OF\_CLUBS
- C. SIX\_OF\_HEARTS
- D. SIX\_OF\_SPADES

Which card do you want to throw away (A, B, C, D)? B

Held cards:

- A. SIX\_OF\_CLUBS
- B. TWO\_OF\_SPADES
- C. SIX\_OF\_HEARTS
- D. SIX\_OF\_SPADES

Which card do you want to throw away (A, B, C, D)? B

Human wins!

Human's cards:

- SIX\_OF\_CLUBS
- SIX\_OF\_DIAMONDS
- SIX\_OF\_HEARTS
- SIX\_OF\_SPADES

Computer's cards:

- SEVEN\_OF\_HEARTS
- TEN\_OF\_HEARTS
- SEVEN\_OF\_CLUBS
- SEVEN\_OF\_DIAMONDS

Although *Four of a Kind* isn't much of a card game, you might decide to share the `FourOfAKind` application with a friend. However, if you forget to include even one of the application's five supporting classfiles, your friend will not be able to run the application.

You can overcome this problem by bundling `FourOfAKind`'s six classfiles into a single *JAR* (Java ARchive) file, which is a ZIP file that contains a special directory and the `.jar` file extension. You can then distribute this single JAR file to your friend.

The JDK provides the `jar` tool for working with JAR files. To bundle all six classfiles into a JAR file named `FourOfAKind.jar`, you could specify the following command line, where `c` tells `jar` to create a JAR file and `f` identifies the JAR file's name:

```
jar cf FourOfAKind.jar *.class
```

After creating the JAR file, try to run the application via the following command line:

```
java -jar FourOfAKind.jar
```

Instead of the application running, you'll receive an error message having to do with the `java` application launcher tool not knowing which of the JAR file's six classfiles is the *main classfile* (the file whose class's `main()` method executes first).

You can provide this knowledge via a text file that's merged into the JAR file's *manifest*, a special file named `MANIFEST.MF` that stores information about the contents of a JAR file and which is stored in the JAR file's `META-INF` directory. Consider Listing B-7.

*Listing B-7. Identifying the Application's Main Class*

```
Main-Class: FourOfAKind
```

Listing B-7 tells java which of the JAR's classfiles is the main classfile. (You must leave a blank line after `Main-Class: FourOfAKind`.)

The following command line, which creates `FourOfAKind.jar`, includes `m` and the name of the text file providing manifest content:

```
jar cfm FourOfAKind.jar manifest *.class
```

This time, `java -jar FourOfAKind.jar` succeeds and the application runs because java is able to identify `FourOfAKind` as the main classfile.

**Note** Now that you've finished this book, you're ready to dig deeper into Android app development. Check out *Beginning Android 4* by Grant Allen (Apress) and *Android Recipes Second Edition* by Dave Smith and Jeff Friesen (Apress) for guidance. After you've learned some more app development basics, perhaps you might consider transforming *Four of a Kind* into an Android app.



---

# Index

## A

### Abstract classes and methods

- abstract final class Shape, 169
- abstract reserved word, 168–169
- graphics class, 168
- instantiating shape, 168
- shape class, 167

### Abstract Window Toolkit (AWT)

- description, 902
- Swing, 924

### Advanced language features

- annotations (see Annotations)
- anonymous class, 197
- assertions (see Assertions)
- enums (see Enumerated type)
- exceptions (see Exceptions)
- generics (see Generics)
- import statement, 207
- inner classes and memory leaks, 202
- interfaces and classes, 203
- local class, 200
- mastering packages, 205
- nested types, 189
- nonstatic member classes, 193
- packages (see Packages)
- static imports, 215
- static member classes, 189

### Android

- APIs, 20, 25–26
- application framework, 26
- C/C++ libraries, 26
- Dalvik virtual machine, 27
- description, 20
- DEX, 27
- Eclipse IDE, 20
- Google, 21

- HelloWorld, 28
- implementation, 28
- Java code, 27
- Java programming language, 25
- layered architecture, 24
- Linux kernel, 27
- Linux process, 27
- mobile devices, 20
- permissions, 28
- runtime environment, 27
- sandbox, 28
- security model, 28
- software stacks, 24
- subsequent releases, 21–24
- user interface screen, 28
- virtual machine, 20, 27

### Annotations

- declaration
  - element, 249
  - stub annotation type, 248
  - stubbed-out method, 249
  - stub instance's elements, 250
  - stub instance's value() element, 250
- @deprecated annotations, 246
- deprecated field, 246–248
- description, 245
- @override annotations, 245
- processing
  - StubFinder application, 253
  - throws exception, 254
- @suppresswarnings annotations, 248

### Apache Harmony, 885

- APIs. See Application program interfaces (APIs)
- Application program interfaces (APIs). See *also*
  - Basic APIs
    - Android, 21
  - arrays and collections utility

Application program interfaces (APIs) (*cont.*)

- binary search, [476](#)
- collections class, [477](#)
- empty and nonempty lists, [478](#)
- linear search, [476](#)
- methods, [475](#)
- internationalization, [914](#)
- Java Android, [9](#)
- JDK 7 documentation, [9](#)
- legacy collection
  - BitSet, [480](#)
  - dictionary, [480](#)
  - hashtable, [480](#)
  - stack, [480](#)
  - vector, [479](#)
  - logging API, [959](#)
- software library, [1](#)
- Arraycopy() method, [323](#)
- ArrayDeque
  - constructors, [447](#)
  - definition, [447](#)
  - stack, [447](#)
- ArrayList
  - constructors, [415](#)
  - demonstration, [416](#)
  - description, [415](#)
- Assertions
  - avoidance, [243](#)
  - control-flow invariants, [239](#)
  - description, [236](#)
  - design-by-contract
    - class invariants, [243](#)
    - postconditions, [242](#)
    - preconditions, [240](#)
  - enabling and disabling, [244](#)
  - internal invariants, [237](#)
  - statement forms, [236](#)
  - using, [237](#)
- Atomic variables
  - classes, [533](#)
  - getNextID() class method, [534](#)
  - synchronization, [534](#)
- Autoboxing, [410](#)
- Automatic Resource Management, [888](#)

**B**

- Babel Fish, Yahoo!, [925](#)
- Basic APIs
  - absolute values, byte and short integers, [293](#)
  - BigDecimal (see [BigDecimal](#))
  - BigInteger, [301](#)
  - exploring number, [295](#)
  - graphing sine and cosine waves, [290](#)
  - math methods, [287](#)
  - primitive type wrapper classes
    - Boolean, [305](#)
    - character, [307](#)
    - float and double, [308](#)
    - integer, long, short, and byte, [312](#)
  - StrictMath and strictfp, [294](#)
- String
  - constructors and methods, [315–316](#)
  - description, [314](#)
  - iteration, [318](#)
- StringBuffer
  - constructors and methods, [319](#)
  - demonstration, [320](#)
- StringBuilder, [318, 320](#)
- synchronization
  - checking account, [336](#)
  - deadlock, [349](#)
  - mutual exclusion, monitors, and locks, [339](#)
  - object, [339](#)
  - thread-local variables, [352](#)
  - utility class, returning unique IDs, [339](#)
  - visibility, [340](#)
  - waiting and notification, [343](#)
- system methods, [322](#)
- threads
  - description, [324](#)
  - exception, [333](#)
  - joining default thread with background
    - thread, [331](#)
  - main() method, [327](#)
  - methods, [326](#)
  - preemptive scheduling, [329](#)
  - scheduler, [329](#)
  - thread sleep, [330](#)

- time slices, 329
- uncaught exception handlers, 334
- Windows 7 platform, 328

### BigDecimal

- based invoice calculations, 300
- constants, 297
- constructors and methods, 298
- floating-point-based invoice calculations, 296
- RoundingMode constants, 299
- salesTaxPercent, 300

### BigInteger

- comparing factorial() methods, 303
- constructors and methods, 302
- description, 301

### Bin directory, 766

### Boolean primitive type wrapper class, 305

### BreakIterators, 935

### BufferedOutputStream and BufferedInputStream, 588

### ByteArrayOutputStream and ByteArrayInputStream, 573

### ByteBuffer

- allocation and wrapping, 671
- bytes.length capacity, 671
- class methods, 670
- external arrays, 672
- internal byte array, 671
- nondirect byte buffers, 671
- view buffers, 673

### Bytes transferring, channels

- demonstration, 705
- methods, 704
- standard output stream, 706

## C

### Cache clearing, 926

### CallableStatement

- connection's prepare Call() methods, 789
- definition, 788
- employee firing, 790
- FIRE, 789
- fire() method, 793
- Java DB syntax, 789

### Candidate bundle names, 918–919

### CAS. See Compare-and-Swap (CAS)

### Cast operator

- 16-bit unsigned character values, 60
- compound expressions application, 59–60
- description, 59
- primitive-type conversions, 59

### Channels, NIO

- asynchronously closeable, 683
- bytes copying, standard input and output streams, 684
- data transfer, 681
- definition, 681
- direct byte buffer, 685
- implementation methods, 682
- in depth
  - file channels, 689–690, 692
  - hole, 692
  - locking files (see Locking files)
  - read() and write() methods, 691
  - scatter/gather, 686–687
  - transferring bytes (see Bytes transferring, channels)
  - unicode values, 689

### interruptible, 683

### I/O classes, 684

### java.nio.channels package, 684

### pipes

- bytes, producing and consuming, 720
- definition, 720
- methods, 720
- receiver task's run() method, 722

### ReadableByteChannel, 682

### shut down, 683

### socket channels (see Socket channels)

### WritableByteChannel, 682

### Character, primitive type wrapper

- classes, 307

### Charsets. See New I/O (NIO)

### Checked exception, 221

### Classes

- application, 91
- arrays
  - creation syntax, 135
  - elements, 134
  - initialization, 135
  - multidimensional, 136
  - object references, 136
  - ragged array, 137

Classes (*cont.*)

- behaviors representation via methods, [107](#)
- class initializers, [124](#)
- class methods
  - `dumpMatrix()`, [108](#)
  - header, [107](#)
  - method-invocation stack, [109](#)
  - `public static void main(String[] args)`, [107–108](#)
  - syntax, [107](#)
- declaration, [89](#)
- garbage collector, [131](#)
- hiding information
  - contract, [119](#)
  - helper methods, [119](#)
  - interface separation, [120](#)
  - Java support, [120](#)
  - package-private, [120](#)
  - private, [120](#)
  - protected, [120](#)
  - public, [120](#)
  - related language feature, [122](#)
  - revising implementation, [121](#)
- initialization order, [128](#)
- instance initializers, [126](#)
- objects
  - application, [97](#)
  - construction syntax, [92](#)
  - default constructor, [93](#)
  - explicit constructors, [93](#)
- return statement
  - chaining instance method calls, [113](#)
  - instance method, [111](#)
  - Java, [113](#)
  - syntax, [111](#)
- state and behaviors encapsulation
  - field-access rules, [106](#)
  - fields, declaration and access, [99](#)
  - instance field, declaration and access (see Instance field)
  - instance methods, [109](#)
  - method-invocation rules, [118](#)
  - overloading methods, [116](#)
  - pass-by-value passes, [114](#)
  - recursion, [115](#)
  - state via fields, [99](#)

## Classes, list of

- ClassLoader class, [918](#)
- EventQueue class, [924](#)
- Image class, [923](#)
- ImageIcon class, [924](#)
- JOptionPane class, [924](#)
- ListResourceBundle class, [918, 922](#)
- Properties class, [920](#)
- PropertyResourceBundle class, [918, 920](#)
- Toolkit class, [923](#)
- Classic I/O APIs
  - filesystem (see Filesystem)
  - java.io package, [620](#)
  - RandomAccessFile (see RandomAccessFile)
  - standard I/O, [607](#)
  - streaming sequences, [620](#)
  - streams (see Streams)
  - writers and readers
    - and InputStream, [610](#)
    - and OutputStream, [610](#)
    - byte streams, [607](#)
    - character sets and encodings, [608](#)
    - classes, [610](#)
    - FileWriter and FileReader, [617](#)
    - Java's stream classes, [607](#)
    - OutputStreamWriter and InputStreamReader, [612](#)
    - stream characters, [607](#)
- Class invariants, [243](#)
- ClassLoader.getResource(), [918](#)
- Classloaders
  - and resources, [899](#)
  - description, [891](#)
  - mechanics, [892](#)
  - problems, [897](#)
  - types, [891](#)
- Cloning
  - deep copying/cloning, [150](#)
  - shallow cloning, [149](#)
- Collators, [939](#)
- Collections framework
  - addAll method, [407](#)
  - add method, [407](#)
  - comparable vs. comparator, [402](#)
  - core interfaces
    - description, [401](#)
    - hierarchy, [402](#)

- definition, 401
  - elements, 404
  - implementation classes, 401–402
  - iterable and collection, 404
  - methods, 405
  - utility classes, 401
  - Comparator, 404
  - Compare-and-Swap (CAS), 535
  - CompareTo() method, 403
  - Composition, 157
  - Concurrency utilities
    - atomic variables (see Atomic Variables)
    - Compare-and-Swap (CAS), 535–536
    - concurrent collections
      - BlockingQueue and ArrayBlockingQueue, 516–517
      - ConcurrentHashMap, 518
      - java.util.concurrent package, 515
      - properties, 515
      - thread-safe collections, 515
    - contended synchronization, 535
    - definition, 488
    - delayed lock, 535
    - executors (see Executors)
    - lock (see Locking framework)
    - low-level threads API, problems, 487
    - mutual exclusion, 535
    - packages, 488
    - synchronizers (see Synchronizers)
    - visibility, 535
  - Console-based application, 902
  - Console methods, 903
  - Constant interfaces, 215
    - Constants, locale class, 915
    - Constructors, locale class, 915
  - Control-flow invariant, 239
  - Cookies
    - CookieHandler class, 658
    - CookieManager
      - methods, 658
      - objects, 658
    - description, 657
    - HTTP protocol handler, 658
    - HTTP response, 657
    - listing, 659
  - Covariant return type
    - definition, 172
    - demonstration, 172
    - upcasting and downcasting, 173
    - createImage(), toolkit class, 923
- ## D
- Dalvik Executable (DEX), 27
  - Databases, accessing
    - Java DB (see Java DB)
    - Java supports database, 763
    - JDBC (see JDBC)
    - SQLite, 772
  - Data Definition Language (DDL), 769
  - Datagram channels
    - client, 716
    - methods, 714
    - read() and write() methods, 715
    - send() method, 716
    - server, 716
    - stock ticker server, implementation, 717–718
  - DatagramSocket
    - client context, 635
    - DatagramPacket(byte[] buf, int length), 633
    - DatagramSocket(), 633
    - DatagramSocket(int port), 633
    - definition, 632
    - EchoClient, 633
    - main() method, 634
    - void receive(DatagramPacket dgp), 633
    - void send(DatagramPacket dgp), 633
  - DataOutputStream and DataInputStream, 590
  - Date constructors and methods, 942
  - Date formatters, 951
  - Dates, Time Zones, and Calendars, 941
  - DDL. See Data Definition Language (DDL)
  - Deadlock, 349
  - Deque
    - array, 447
    - definition, 443
    - Java documentation, 446
    - methods, 443
    - queue/equivalent methods, 446
  - Design patterns, 905
  - DEX. See Dalvik Executable (DEX)
  - Diamond operator, 887
  - Direct byte buffers, 680
  - Document object model (DOM)
    - advantages, SAX, 843
    - creating XML documents

Document object model (DOM) (*cont.*)

- DocumentBuilder, 846–847, 853
- DOMDemo, 853
- outputs, 855
- exploring DOM API, 845–846
- levels, 843
- nodes
  - attribute node, 844
  - CDATA section node, 844
  - child (leaf) node, 843
  - comment node, 844
  - document fragment node, 844
  - document node, 844
  - document type node, 844
  - element node, 844
  - entity node, 844
  - entity reference node, 845
  - notation node, 845
  - parent node, 843
  - processing instruction node, 845
  - text node, 845
- parsing XML documents
  - DOMDemo, 850
  - elements, 849
  - node methods, 847–848
  - XML content, 852
- validation API, 846–847

Document type definition (DTD)

- attribute declaration, 816
- attribute types, 816
- definition, 815
- document type declaration, 817
- element declarations, 815
- general entities, 818
- internal, 817
- parameter entities, 819
- XML parser, 816

Double brace initialization, 909

Downcasting

- array, 171
- description, 169
- DowncastDemo, 170
- trouble, 169

Drawable interfaces

- declaration, 175
- draw() method, 175
- implementation, 176

DumpArgs

- command-line interface, 12
- for loop, 12
- javac, 12
- main(), 11
- source code, 11
- System.out.println(args[i]), 12

## E

Early binding, 166

EchoClient, 630–631

EchoServer, 632

EchoText

- Boolean, 13
- command-line arguments, 13–14
- javac, 14
- main(), 13
- outputting text, 13
- standard input stream, 13
- System.in.read(), 14
- System.out.println(), 14
- while loop, 14

EE. See Enterprise Edition (EE)

Embedded ij script session, 770

Employees database creation, 770

Enterprise Edition (EE), 6

Enumerated type

- class, 280
- compile-time type safety, 275
- description, 273
- enhancement, 276
- extending class, 281
- switch statement, 275
- traditional, 273

EnumMap, 467

EnumSet, 425

Equals() method

- hashCode() method, 154
- point objects, 153
- relation, nonnull object references, 152

ErrorManager, 977

Event-dispatching thread, 924

EventQueue.invokeLater(), 924

Exceptions

- cleanup, 229
- custom exception classes, 222

- description, 218
  - error, 218
  - handling, 226
  - rethrowing, 229
  - source code representations
    - checked vs. runtime, 221
    - error codes vs. objects, 218
    - throwable class hierarchy, 219
  - throwing, 223
  - Executors
    - class's static methods, tasks, 494
    - definition, 489
    - Euler's number *e*, 494, 496
    - ExecutorService Methods or callable tasks, 490
    - "obtain word entries" task, 493
  - Exploring preferences, 982
  - Expressions
    - compound, 49–53
    - description, 43
    - simple (see Simple expressions)
  - Extending classes
    - Inheriting Members, 143
    - multiple implementation inheritance, 147
    - overriding a method, 145
    - relating two classes, 142
  - Extensible Stylesheet Language (XSL), 875
  - Externalization, 602
- F**
- FileDescriptor
    - boolean valid(), 560
    - void sync(), 560
  - FileOutputStream and FileInputStream, 576
  - Filesystem
    - accept() method, 549
    - construction, 542
    - creation and manipulation, 552
    - description, 539, 620
    - disk space information, 548
    - DumpRoots application, 539
    - FilenameFilter interface, 549
    - File object's abstract pathname, 548
    - java.io.File class, 539
    - java.io.FileFilter interface, 550
    - miscellaneous methods, 555–556
    - pathname's file/directory, 546
    - setting and getting permissions, 554
    - specify java Dir c:\windows exe, 549
    - stored abstract pathnames, 544
  - Filtering LogRecords, 968
  - FilterOutputStream and FilterInputStream, 587
    - scrambling
      - file's bytes, 582
      - output, fonts yield, 583
      - stream of bytes, 580
    - unscrambling
      - file's bytes, 586
      - stream of bytes, 584
  - Finalization
    - definition, 154
    - super.finalize(), 155
  - First-In, First-Out (FIFO) queue, 438
  - Flat file database
    - implementation, 564
    - records and fields, 561
  - Formatters, 948
  - Four of a Kind
    - compiling, running and distributing, 1145–1148
    - player examines, 1127
    - pseudocode, 1128–1144
- G**
- Garbage collector
    - C++ implementations, 132
    - memory leakage, 132
    - referenced object, 131
    - stacks, 133
    - unreferenced object, 131
  - Generics
    - and arrays, 271
    - generic type
      - actual type argument, 258
      - declaration and using, 259
      - description, 258
      - parameter bounds, 262
      - parameterized types, 258
      - parameter scope, 265
      - raw type, 259
      - wildcards, 265
    - methods
      - copyList() generic method, 269
      - formal\_type\_parameter\_list, 268
      - generic constructors, 270
      - type inference algorithm, 270

Generics (*cont.*)

- type safety, 255
- getBundle() class methodsproperty resource bundles, 921
- ResourceBundle class, 917–919
- getCookieStore(), 659
- getDefault() class method, 658, 915
- getMTU() method, 655
- getObject() method, 919
- Greedy quantifier, 740

**H**

## Handlers and formatters, 971

## Hash codes

- hashing, 156
- Java documentation, 156

## Hash map

- collision, 454
- constructors, 455
- demonstration, 455
- hash code, 453
- hash function, 453–455
- Image Caches, 459–463
- load factor, 455
- overriding hashCode, 456

## HashSet

- constructors, 421
- demonstration, 421
- description, 420
- not overriding hashCode, 422
- overriding hashCode, 423

HTML. See HyperText Markup Language (HTML)

HTTP. See HyperText Transfer Protocol (HTTP)

Hybrid library, 990–995

HyperText Markup Language (HTML), 643

HyperText Transfer Protocol (HTTP), 639

**I**

Identity check, 152

## If-else statement

- boolean expression, 72
- conditional operator, 72
- dangling-else problem, 74, 75
- GradeLetters application, 73–74

Image class, list resource bundles, 923

Imagelcon class, 924

Immutability, 911

## Implementation inheritance

- appointment calendar class, 158
- vs. composition, 157
- extending appointment calendar class, 159
- forwarding, 160
- fragile base class problem, 160
- Logging Appointment Calendar Class, 161
- wrapper class, 161

## InetAddress

- InetAddress[] getAllByName(String host), 624
- InetAddress getByAddress(byte[] addr), 624
- InetAddress getByAddress(String hostName, byte[] ipAddress), 624
- InetAddress getByName(String host), 625
- InetAddress getLocalHost(), 625

InetSocketAddress, 625

## Inheritance

- definition, 141
- implementation, 141
- interface, 142
- single and multiple, 141

Initialization, double brace, 909

## Instance fields

- Car Class declaration, 102
- constant, 105
- direct access, 102
- Employee class, constant declaration, 105
- initialization via constructors, 103
- nonzero default value, 103
- syntax, 101

## Integrated development environment (IDE)

- command-line arguments, 19
- console tab, 18
- DumpArgs, 17
- Eclipse, 15
- Eclipse user interface, 17
- JDK's tools, 15
- JRE System Library items, 18
- Program arguments, 19
- splash screen, 15
- welcome tab, 16
- workbench, 17
- workspace, 15–16

## Interfaces

- agile software development, 182
- declaration, 174
- drawable interface, 182
- extending, 180



- fluent interface, [910–911](#)
  - formalizing class, [174](#)
  - implementation, [176](#)
  - inheritance, [177](#), [180](#)
  - profiling, [183](#)
  - Internationalization
    - APIs
      - Locale class, [914–915](#), [1012](#)
      - ResourceBundle pattern, [917](#)
    - description, [914](#), [1011](#)
    - International Standards Organization (ISO), [915](#)
    - locales, [915](#), [1012](#)
    - resource bundles, [916](#), [1012](#)
    - Unicode, [914](#)
  - International Standards Organization (ISO), [915](#), [916](#)
  - Internet Protocol Version 4 (IPv4) address, [622](#)
  - Internet Protocol Version 6 (IPv6) address, [622](#)
  - Iterator interface
    - autoboxing and unboxing, [409](#)
    - enhanced for loop statement, [408](#)
    - methods, [408](#)
- ## ■ J, K
- JAR API, [1003–1006](#)
  - Java
    - APIs, [1](#)
    - bytecode, [4](#)
    - C and C++, [2](#)
    - classfile, [4–5](#)
    - description, [2](#)
    - EE, [6](#)
    - execution environment, [4](#)
    - IDE (see Integrated development environment (IDE))
    - implementation sizes, [3](#)
    - interpretation, [5](#)
    - JDK (see Java SE Development Kit (JDK))
    - JIT compilation, [5](#)
    - JNI, [5](#)
    - JVM, [4–5](#)
    - loops and expressions, [3](#)
    - ME, [6](#)
    - operators, [2](#)
    - portability, [6](#)
    - SE, [6](#)
    - secure environment, [6](#)
    - single-and multi-line, [2](#)
    - source code, [2](#)
    - standard class library, [4](#)
    - sun microsystems, [2](#)
  - Java 6
    - boolean setExecutable(boolean executable), [553](#)
    - boolean setExecutable(boolean executable, boolean ownerOnly), [553](#)
    - boolean setReadable(boolean readable), [553](#)
    - boolean setReadable(boolean readable, boolean ownerOnly), [553](#)
    - boolean setWritable(boolean writable), [553](#)
    - boolean setWritable(boolean writable, boolean ownerOnly), [553](#)
    - long getFreeSpace() returns, [546](#)
    - long getTotalSpace() returns, [546](#)
    - long getUsableSpace() returns, [546](#)
  - java.awt.Image class, [923](#)
  - java.awt.Toolkit class, [923](#)
  - Java Class, [991](#)
  - Java code
    - computer player, [1130](#)
    - merging suits and ranks, [1132](#)
  - Java DB
    - client/server environment, [768](#)
    - command-line tools, [769](#)
    - demos, [767](#)
    - embedded database engine, start up/shut down, [764](#)
    - embedded driver, [764](#)
    - installation and configuration, [766](#)
    - log directory creation, [765](#)
    - multiple clients communication, [765](#)
    - SimpleApp derbyClient command, [768](#)
    - java.lang package, ClassLoader class, [918](#)
  - Java native interface (JNI), [5](#), [990](#)
  - Java SE Development Kit (JDK)
    - Android (see Android)
    - APIs, [9](#)
    - App.class, [8](#)
    - brace characters, [9](#)
    - command-line interface, [8](#)
    - development tools, [7](#)
    - documentation, [9](#)
    - DumpArgs, [11](#), [13](#)
    - EchoText, [13–15](#)
    - HelloWorld.class, [11](#)

Java SE Development Kit (JDK) (*cont.*)

- home directory, 7–8
- IDE, 18
- Javac, 11
- JRE, 7
- line feed, 10
- main(), 10
- public class, 9
- source code, 9
- standard class library, 8
- static and void, 10
- String[] args, 10
- System.out.println, 10
- java.util.jar package, 569
- java.util package
  - ListResourceBundle class, 918
  - Locale class, 915, 1012
  - Properties class, 920
  - PropertyResourceBundle class, 918
  - ResourceBundle class, 917
- Java virtual machine (JVM), 4–5, 519
- javax.swing.Imagelcon, 924
- JDBC
  - data sources, 774, 775
  - DriverManager, 775
  - driver types, 774
  - exceptions, 777
  - Java 7, 775
  - statements
    - CallableStatement, 788
    - definition, 781
    - executeQuery() method, 784
    - JDBCDemo application, 781
    - Metadata (see Metadata)
    - methods, 781
    - PreparedStatement, 785
    - SQL Type/Java type mappings, 784
  - URLAttributes, 776
  - URL syntax, 776
  - Xerial SQLite driver, 776
- JIT. See Just-in-time (JIT)
- JNI. See Java native interface (JNI)
- JOptionPane, 924
- Just-in-time (JIT), 5
- JVM. See Java virtual machine (JVM)

## L

- Last-In, First-Out (LIFO) queue, 438
- Late binding, description, 166
- Learning language fundamentals
  - application structure, 31–33
  - comments
    - description, 33
    - Javadoc, 34–35, 37
    - multiline, 33
    - single-line, 33
  - description, 31
  - expressions (see Expressions)
  - identifiers, 37–38
  - operators (see Operators)
  - precedence and associativity
    - 32-bit integer, 69
    - compound expression, 67
    - interprets, 69
    - open and close parentheses, 68
    - public class CompoundExpressions, 68
  - statements (see Learning statements)
  - types
    - array, 41
    - data items, 38
    - integers, 38
    - user-defined, 41
  - types (see Primitive types)
  - variables, 42
- Learning statements
  - assignment, 71
  - break and labeled break
    - employee search application, 82
    - infinite loop, 81
    - system.out.println, 83
  - compound, 70
  - continue statement, 83–84
  - decision, 71
  - do-while statement, 80
  - empty, 81
  - for statement, 77–78
  - If-else (see If-else statement)
  - if statement, 71–72
  - labeled continue, 84
  - loop, 76
  - simple, 70

- switch, 75–76
- while statement, 78, 80
- Lib directory, 766
- Linear congruential generator, 360
- LineNumberInputStream, 569
- LinkedList
  - constructors, 418
  - linked nodes, demonstration, 418
  - node, 417
- List
  - ArrayList, 415
  - description, 411
  - LinkedList, 416
  - ListIterator, methods, 414
  - methods, 412
- ListResourceBundle class, 918, 922
- Locale class
  - constants, 915
  - constructors, 915
  - getDefault method, 915
  - getISOCountries method, 916
  - getISOLanguages method, 916
  - Internationalization APIs, 1012
  - resource bundles, 917
  - setDefault method, 915
- Lock, 340
- Locking files
  - command line, 699
  - counter variable's current value, 698
  - database management system, 693
  - demonstration, 696
  - exclusive and shared, 693
  - fileLock's methods, 693, 695
  - main() method, 698
  - methods for obtaining, 694
  - output, 700
  - pattern, 696
  - query() method, 699
- Locking framework
  - condition
    - lockstep synchronization, 529
    - methods, 524
    - synchronization, 524
  - lock
    - acquisition and release, 520
    - methods, 519
    - producer and consumer constructors, 528
    - shared's constructor, 528

- ReadWriteLock, 529
- ReentrantLock
  - blocking queue, 523
  - constructors, 521
  - synchronization, 521
- ReentrantReadWriteLock
  - constructors, 529
  - java Dictionary, 533
  - methods, 530
  - thread's working memory, 519
  - visibility, 519
- Logger hierarchy, 960–962
- Logging, 614, 958
- LogManager and configuration, 974

## M

- Mapping files, memory
  - demonstration, 702
  - map() method, 701
  - mode parameter, 701
  - output, 704
  - position and size parameters, 701
  - specified mapping mode, 701
  - virtual memory, 700
- Maps
  - collection views, 450
  - entry methods, 451
  - EnumMap, 467
  - hash map, 453
  - IdentityHashMap, 463
  - methods, 448
  - navigable (see Navigable maps)
  - TreeMap, 452
  - WeakHashMap, 465
- Math's random() method, 359
- ME. See Micro Edition (ME)
- Message formatters, 953
- Metadata
  - catalog and schema, 796
  - DatabaseMetaData getMetaData()
    - method, 794
  - employee Data Source, 794
  - employees existence, determination, 797
  - isExist() function, 797
  - SQL, 796
  - SYS schema stores, 797
- Micro Edition (ME), 6

- MissingResourceException
    - getBundle method throwing, 918
    - getObject method throwing, 919
    - getString method throwing, 921
  - Multicasting
    - datagram packets, 636
    - definition, 636
    - group address, 636
    - int getLength() method, 638
    - main() method, 638
    - receiving datagram packets, 637
  - Multicatch, 887
  - Multipurpose Internet Mail Extensions [MIME]
    - type, 643
  - Mutual exclusion, 339, 535
- N**
- Native interface library, 992
  - Navigable maps
    - definition, 471
    - methods, 472
    - tree map, 474
  - Navigable sets
    - description, 435
    - methods, 435
    - tree set, 437
  - NetworkInterface
    - description, 652
    - enumeration, 654
    - methods, 652
  - NetworkInterfaceAddress
    - enumeration, 656
    - methods, 655
    - NetInfo, 656
  - Network Interface Card (NIC), 623
  - New I/O (NIO)
    - buffer
      - byte ordering, 679
      - byte-oriented buffer, 666, 669
      - creation (see ByteBuffer)
      - definition, 666
      - direct byte buffers, 680
      - flipping, 675
      - in depth, 670
      - java.nio package, 668
      - marking, 677–678
      - methods, 667
      - properties, 666
      - subclass operations, 679
      - writing and reading, 674–675
    - channels (see Channels, NIO)
    - charsets
      - byte order mark, 744
      - byte sequences, 745
      - character, 743
      - character-encoding scheme, 744
      - character set, 743
      - coded character set, 743
      - definition, 744
      - Internet Assigned Names Authority (IANA), 744
      - methods, 750
      - standards, 744
      - String class, 750
      - Unicode, 743
    - definition, 665
    - formatter
      - constructors, 752
      - conversions, 753
      - demonstration, 754
      - output, 755
      - printf(), 756
      - problem solving ways, 755
      - syntaxes, 752
      - void close() method, 753
    - regular expressions (see Regular expressions)
    - scanner
      - constructors, 756
      - delimiter pattern, 756
      - output, 758
      - scanning input, menu context, 757
    - selectors
      - attachment, 725
      - code fragment, 727
      - definition, 724
      - interest set, 724
      - key, 724
      - nonblocking mode, 723, 725
      - readiness selection, 724
      - receiving time, server, 731
      - selectable channels, 724, 728
      - selected keys, 726
      - server socket channel, 730
      - serving time to clients, 728

- source code, [732](#)
- streams, [723](#)
- NIC. See Network Interface Card (NIC)
- Node, [417–419](#)
- Nonstatic member class
  - declaration, [194](#)
  - description, [193](#)
  - instance method, [194](#)
  - ToDo instances, [ToDoArray](#)
    - instance, [195–196](#)
  - To-Do items, name-description pairs, [195](#)
  - ToDo List of ToDo instances, [197](#)
- Number formatters, [948](#)
- Numeric literal enhancements, [886](#)

## O

- Object-based language, [141](#)
- Objects creation. See Classes
- Operators
  - additive, [54–55](#)
  - array index, [56–57](#)
  - assignment, [57](#)
  - bitwise, [57–58](#)
  - cast (see Cast operator)
  - conditional, [61–62](#)
  - equality, [62](#)
  - logical, [63–64](#)
  - member access, [64](#)
  - method call, [65](#)
  - multiplicative, [65–66](#)
  - object creation, [66](#)
  - relational, [66](#)
  - shift, [66–67](#)
  - unary minus/plus, [67](#)

## P

- Packages
  - and JAR files, [215](#)
  - description, [206](#)
  - names, [206](#)
  - playing, [210](#)
  - searching
    - compile-time search, [209](#)
    - runtime search, [209](#)
  - statement, [207](#)
- Parallelism, [488](#)
- Parsing, [956](#)
- PartsDB class
  - append() method, [564](#)
  - declares constants, [564](#)
  - description, [564](#)
  - numRecs() method, [564](#)
  - RandomAccessFile's close() method, [564](#)
  - select() method, [564](#)
  - update() method, [564](#)
- Phantomreference
  - description, [366](#)
  - large object's finalization, [366](#)
  - main() method, [367](#)
  - T r, ReferenceQueue<? super T> rq, [366](#)
  - uses, [366](#)
- PipedOutputStream and PipedInputStream, [579](#)
- Polymorphism
  - coercion, [162](#)
  - description, [162](#)
  - overloading, [162](#)
  - parametric, [162](#)
  - subtype, [163–164](#)
- Possessive quantifier, [740–741](#)
- PreparedStatement, [785](#)
- Primitive types
  - binary vs. decimal, [39](#)
  - definition, [38](#)
  - minimum and maximum values, [40](#)
  - two byte-integer values, [40](#)
- Primitive type wrapper classes
  - Boolean, [305](#)
  - definition, [305](#)
- PrintStream
  - description, [568–569](#)
  - features, [605](#)
  - line separator, [605](#)
  - stream classes, [604](#)
  - System.out.println(), [605](#)
  - various print() and println() methods, [604](#)
  - void println() method, [605](#)
- PriorityQueue
  - comparator, [442](#)
  - constructors, [440](#)
  - description, [438, 440](#)
  - integers, [441](#)
  - ordering elements, [440](#)
- Properties files, [919–920](#)
- PropertyResourceBundle class, [918–921](#)
- Protocol stack, [623](#)

## Pseudocode

- description, [1128](#)
- Java code (see Java code)
- refined, [1129](#)

Pseudorandom numbers, [360](#)**Q**

## Queues

- First-In, First-Out (FIFO) queue, [438](#)
- Last-In, First-Out (LIFO) queue, [438](#)
- methods, [439](#)
- PriorityQueue (see PriorityQueue)

**R**

## Random numbers

- array of integers, shuffling, [361](#)
- boolean nextBoolean(), [360](#)
- double nextDouble() method, [360](#)
- double nextGaussian(), [361](#)
- float nextFloat(), [361](#)
- int nextInt(), [361](#)
- int nextInt(int n), [361](#)
- linear congruential generator, [360](#)
- long nextLong(), [361](#)
- pseudorandom numbers, [360](#)
- Random(), [360](#)
- Random(long seed), [360](#)
- random number generators, [359](#)
- void nextBytes(byte[] bytes), [361](#)

## RandomAccessFile

- description, [556](#)
- FileDescriptor, [560](#)
- file pointer, [557](#)
- flat file database, [564](#)
- methods, [559](#)
- platform-dependent structure, [559](#)
- “r”, “rw”, “rws” and “rwd” modes, [557](#)

## References

- boolean enqueue(), [364](#)
- boolean isEnqueued(), [364](#)
- definition, [363](#)
- finalize() method, [362](#)
- phantomreference (see Phantomreference)
- reachability, levels
  - phantom reachable, [363](#)
  - softly reachable, [363](#)
  - strongly reachable, [363](#)

- unreachable, [363](#)

- weakly reachable, [363](#)

- reachable or referenced objects, [362](#)

- referencequeue (see Referencequeue)

- softreference, [365](#)

- subclass, [364](#)

- T get(), [364](#)

- unreachable (not referenced), [362](#)

- void clear(), [364](#)

- weakreference, [365](#)

## Referencequeue

- definition, [363](#)

- Reference<? extends T> poll(), [364](#)

- Reference<? extends T> remove(), [364](#)

- Reference<? extends T> remove(long timeout), [365](#)

- ReferenceQueue(), [364](#)

## Reflection

- accessible objects

- boolean isAccessible(), [383](#)

- boolean isAnnotationPresent(Class<? extends Annotation> annotationType), [383](#)

- <T extends Annotation> T

- getAnnotation(Class<T>

- annotationType), [382](#)

- void setAccessible(boolean flag), [383](#)

- array, [388](#)

- class methods, [369](#)

- class object

- decompileClass() method, [375](#)

- decompiler tool, [374](#)

- forName() method, [372](#)

- getClass() method, [377](#)

- constructor

- Annotation[] getDeclaredAnnotations(), [378](#)

- Class[]<?> getExceptionTypes(), [378](#)

- Class[]<?> getParameterTypes(), [378](#)

- Class<T> getDeclaringClass(), [378](#)

- String getName(), [378](#)

- dynamically loaded class

- newInstance() method, [377](#)

- VideoPlayer class, [378](#)

- field

- boolean getBoolean(Object object), [379](#)

- byte getByte(Object object), [379](#)

- char getChar(Object object), [379](#)

- class, [380](#)

- double getDouble(Object object), [379](#)

- float getFloat(Object object), 379
- int getInt(Object object), 379
- long getLong(Object object), 379
- main() method, 380
- Object get(Object object), 379
- short getShort(Object object), 379
- method
  - boolean isVarArgs(), 381
  - class, 381
  - Class<?> getReturnType(), 381
  - int getModifiers(), 381
  - main(), 382
  - Object invoke(Object receiver, Object... args), 381
- package
  - manifest.mf, 386
  - methods, 383
  - obtaining information, 384
- Regular expressions
  - boundary matcher, 739
  - capturing groups, 738
  - character classes, 737
  - definition, 732
  - Matcher methods, 734
  - ox regex, 736
  - pattern methods, 733
  - PatternSyntaxExceptionMethods, 734
  - period metacharacter, 736
  - practical, 743
  - quantifiers, 740
- Reification, 271
- Reluctant quantifier, 740–741
- Resource-access methods
  - getStringArray method, 919
  - getString method, 919
- ResourceBundle class
  - accessing resources, 919
  - candidate bundle names, 918–919
  - factory methods, 917
  - getBundle methods, 917–919
  - ListResourceBundle class, 918, 922
  - patterns, 917
  - properties files, 919
  - PropertyResourceBundle class, 918, 919, 921
  - setParent method, 919
- Runtime and process, 986
- Runtime exception, 221

## 

 S

- SAX. See Simple API for XML (SAX)
- Scalable vector graphics (SVG), 809
- SE. See Standard Edition (SE)
- ServerSocket
  - accept() method, 628–629
  - echoing data, 629
  - int port, 628
  - int port, int backlog, 628
  - int port, int backlog, InetAddress localAddress, 628
  - ServerSocket(), 628
- setCookiePolicy(), 659–660
- setDefault() sets, 915
- setParent() method, 919
- Sets
  - EnumSet, 425
  - HashSet, 420
  - navigable (see Navigable sets)
  - sorted (see Sorted sets)
  - TreeSet (see TreeSet)
- Shuffle() methods, 361
- Simple API for XML (SAX)
  - Handler, 833
  - methods
    - ContentHandler, 828–829
    - DTDHandler, 830
    - EntityResolver, 830
    - ErrorHandler, 830
    - LexicalHandler, 831
    - XMLReader object, 825, 827
  - SAXDemo, 831–832
  - validation, 827
- Simple expressions
  - application, 48
  - array initializers, 45
  - boolean and character literal, 44
  - counter variable, 46
  - escape sequences, 44
  - floating-point literal, 44
  - integer literal, 44
  - literals, 43
  - null literal, 44
  - one and two-dimensional array, 46
  - primitive-type conversions via widening
    - conversion rules, 47
  - referenced array, 46–47

- Simple expressions (*cont.*)
  - string literal, [44](#)
  - void method, [43](#)
- Simple Mail Transfer Protocol (SMTP), [622](#)
- SMTP. See Simple Mail Transfer Protocol (SMTP)
- Socket
  - echoing data, [629](#)
  - InetAddress dstAddress, int dstPort, [626](#)
  - InetAddress dstAddress, int dstPort, InetAddress localAddr, int localPort, [627](#)
  - InputStream getInputStream() methods, [627](#)
  - options, [625](#)
  - OutputStream getOutputStream() methods, [627](#)
  - Socket(), [627](#)
  - Socket(Proxy proxy), [627](#)
  - String dstName, int dstPort, [627](#)
  - void close() method, [627](#)
- SocketAddress, [625](#)
- Socket channels
  - AsynchronousCloseException, [712](#)
  - datagram (see Datagram channels)
  - definition, [706](#)
  - demonstration, [713](#)
  - exploring server, [709](#)
  - noargument open() method, [712](#)
  - nonblocking mode, [707](#)
  - TCP/IP stream protocol, [712](#)
  - uses, [711](#)
- SoftReference
  - SoftReference(T r), [365](#)
  - T r, ReferenceQueue<? super T> rq, [365](#)
- Sorted maps
  - definition, [468](#)
  - methods, [469](#)
  - tree map, [470](#)
- Sorted sets
  - implementation, [434](#)
  - implementing comparable, [433](#)
  - methods, [428](#)
  - not implementing comparable, [432](#)
  - TreeSet, [428](#), [430](#)
- SQLException, [777](#)
- SQLite, [772](#)
- Standard Edition (SE), [6](#)
- Static member class
  - class and instance methods, [190](#)
  - declaration, [190](#)
  - description, [189](#)
  - multiple implementations, [191](#)
  - rectangle implementations, [192](#)
- StAX. See Streaming API for XML (StAX)
- Strategy implementation, [906](#)
- Strategy pattern, [906](#)
- Streaming API for XML (StAX), [855](#)
- Streams
  - BufferedOutputStream and BufferedInputStream, [588](#)
  - ByteArrayOutputStream and ByteArrayInputStream, [573](#)
  - DataOutputStream and DataInputStream, [590](#)
  - FileOutputStream and FileInputStream, [576](#)
  - FilterOutputStream and FilterInputStream, [587](#)
  - InputStream methods, [572](#)
  - java.io package, [568](#)
  - java.util.zip, [569](#)
  - LineNumberInputStream and StringBufferInputStream, [568](#)
  - output and input, [567](#)
  - OutputStream methods, [570](#)
  - PipedOutputStream and PipedInputStream, [579](#)
  - PrintStream (see PrintStream)
  - serialization and deserialization
    - custom, [602](#)
    - DataOutputStream and DataInputStream classes, [590](#)
    - default, [596](#)
    - externalization, [604](#)
    - virtual machine mechanism, [590](#)
- String. See *also* StringBuffer; StringBuilder
  - constructors and methods, [315](#)
  - description, [314](#)
  - iteration, [318](#)
  - literal, [316](#)
- StringBufferInputStream, [569](#)
- String[] getISOCountries() class method, [916](#)
- String[] getISOLanguages() class method, [916](#)
- String[] getStringArray(String key), [919](#)
- String getString(String key), [919](#)
- String representation, [157](#)
- Stringtokenizer
  - boolean hasMoreElements(), [389](#)
  - boolean hasMoreTokens(), [389](#)
  - description, [388](#)
  - int countTokens(), [389](#)



- loop context, 390
- Object nextElement(), 389
- parsing or tokenizing, 388
- String nextToken(), 389
- String nextToken(String delim), 390
- String str, 389
- String str, String delim, 389
- String str, String delim, boolean returnDelims, 389
- SVG. See Scalable vector graphics (SVG)
- Switch-on-String, 886
- Synchronizers
  - countdown latches
    - coordinated start, 498–499
    - java CountdownLatch, 499–500
    - methods, 497
  - cyclic barriers
    - description, 500
    - methods, 500–501
    - task into subtasks, decomposing, 501, 504
  - exchangers
    - java ExchangerDemo, 508
    - methods, 505
    - swap buffers, 505
  - semaphores
    - controlling thread access, 511
    - and fairness, 510
    - java SemaphoreDemo, 514
    - methods, 510–511
- System.currentTimeMillis() method, 987

## T

- Threads
  - description, 324
  - event-dispatching thread, 924
  - exception, 333
  - joining default thread with background, 331
  - local variables, 352
  - methods, 326
  - preemptive scheduling, 329
  - processors/cores, 329
  - scheduler, 329
  - uncaught exception handlers, 334
- Timer
  - boolean isDaemon, 393
  - cancel() method, 395

- description, 391
- execution thread, 395
- int purge(), 393
- String name, 393
- String name, boolean isDaemon, 393
- task-execution thread, 392
- Timer(), 393
- void cancel(), 393
- void schedule
  - TimerTask task, Date firstTime, long period, 394
  - TimerTask task, Date time, 393
  - TimerTask task, long delay, 394
  - TimerTask task, long delay, long period, 394
- void scheduleAtFixedRate
  - TimerTask task, Date firstTime, long period, 394
  - TimerTask task, long delay, long period, 395

- Timertask
  - boolean cancel(), 395
  - description, 391
  - execution thread, 396
  - long scheduledExecutionTime(), 396
  - one-shot execution, 396
  - repeated execution, 396
  - void run(), 396

- Toolkit class
  - createImage method, 923
  - list resource bundles, 923

- TreeMap
  - constructors, 452
  - definition, 452
  - demonstration, 452

- TreeSet
  - constructors, 419
  - description, 419
  - natural ordering, 420

## U, V

- Ultimate superclass, 148
- Unboxing, 410
  - Unicode, internationalization, 914
- Uniform Resource Identifiers (URIs)
  - absolute, 646
  - definition, 639

Uniform Resource Identifiers (URIs) (*cont.*)

- fragment, [647](#)
- hierarchical, [646](#)
- javac URIComponents.java, [648](#)
- learning about, [648](#)
- namespace, [810](#)
- normalization, [649](#)
- opaque, [646](#)
- path, [647](#)
- query, [647](#)
- registry-based authority, [646](#)
- relative, [646](#)
- relativization, [651](#)
- resolution, [650](#)
- scheme-specific-part, [646](#)
- server-based authority, [647](#)

Uniform Resource Locator (URL). *See also*

- URLConnection
  - definition, [639](#)
  - ListResource's source code, [641](#)
  - openStream(), [640](#), [642](#)
  - protocol prefix, [640](#)
  - String getProtocol(), [640](#)
  - String s, [639](#)

Uniform Resource Name (URN), [639](#)

## Upcasting

- array, [166](#)
- description, [164](#)

URI. *See* Uniform Resource Identifiers (URIs)URL. *See* Uniform Resource Locator (URL)

## URLConnection

- URLConnection, [643](#)
- InputStream getInputStream(), [642](#)
- OutputStream getOutputStream(), [642](#)
- void setDoInput(boolean doInput), [642](#)
- void setDoOutput(boolean doOutput), [642](#)
- void setRequestProperty(String field, String newValue), [642](#)

## URLDecoder

- decoding rules, [644](#)
- encoded string, [645](#)
- String decode(String s, String enc), [644](#)

## URLEncoder

- encoded string, [645](#)
- encoding rules, [643](#)
- String encode(String s, String enc), [644](#)

URN. *See* Uniform Resource Name (URN)**W**WeakHashMap, [465](#)

## Weakreference

- T r, ReferenceQueue<? super T> rq, [365](#)
- WeakReference(T r), [365](#)

**X**

## XML (eXtensible Markup Language)

- ASCII character, [806](#)
- CDATA section
  - description, [809](#)
  - embedded XML document, [809](#)
  - SVG, [809](#)
- character references
  - character entity reference, [809](#)
  - description, [808](#)
  - numeric character reference, [808](#)
- comments, [813](#)
- custom entity resolver
  - external entity, [840](#)
  - LocalRecipeML, [841–842](#)
  - Recipe Markup Language (RecipeML), [840–841](#)
  - SAXDemo, [842](#)
- declaration, [805–806](#)
- description, [803](#)
- DOM, parsing and creating (*see* Document object model (DOM))
- elements and attributes
  - child elements, [807](#)
  - mixed content, [807](#)
  - root element, [807](#)
  - tree structure, [806–807](#)
- grammar document
  - definition, [815](#)
  - DTD (*see* Document type definition (DTD))
  - XML schema, [815](#)
- HTML document, [804](#)
- namespaces
  - default, [812–813](#)
  - Google Chrome, [811](#)
  - namespace prefix, [810](#)
  - pair, [810](#)
  - rules, [814](#)
  - URI-based container, [810](#)

- well-formed documents, [814](#)
- XHTML language, [811](#)
- non-ASCII characters, [806](#)
- processing instructions, [813](#)
- SAX, parsing (see Simple API for XML (SAX))
- schema
  - attribute element, [821](#)
  - complex types, [821](#)
  - content model, [820](#)
  - definition, [820](#)
  - element declaration, [821](#)
  - ingredient elements, [822](#)
  - introductory schema element, [821](#)
  - language document, [820](#)
  - namespace, [824](#)
  - object-oriented approach, [820](#)
  - recipe document's schema, [823](#)
  - restriction, [820](#)
- valid documents, [814–815](#)
- variables and variable resolvers, [873–874](#)
- vocabulary documents, [803](#)
- XMLPULL V1, parsing
  - article.xml file, [858](#)
  - event-based, [855](#)
  - integer-based event type constants, [857](#)
  - JAR file, [855](#)
  - org.xmlpull.v1 package, types, [856](#)
  - pull parsing, [855](#)
  - push parsing, [855](#)
  - StAX, [855](#)
  - stream-based, [855](#)
  - XMLPPDemo, [856](#)
- XPath (see XPath)
- XPath
  - advanced, [868](#)
  - and DOM
    - DOM API, [864](#), [866](#)
    - XML-based contacts database, [863](#)
    - XPath API, [866](#)
  - attributes, [859](#)
  - Boolean expressions, [862](#)
  - compound paths, [860](#)
  - description, [859](#)
  - extension functions and function resolvers, [870–872](#)
  - ingredients, [859](#)
  - language primer, [859](#)
  - location path expressions, [859–861](#)
  - namespace contexts, [868](#), [870](#)
  - nodeset, [859](#)
  - numeric values, functions, [862](#)
  - predicates, [860–861](#)
  - strings, functions, [862–863](#)
  - unknown nodes, wildcards, [860](#)
  - XPathExpression interface, [868](#)
  - XPathFactory instance, [867](#)
- XSL. See Extensible Stylesheet Language (XSL)
- XSLT. See XSL Transformation (XSLT)
- XSL Transformation (XSLT)
  - demonstrating XSLT API, [878–881](#)
  - exploring XSLT API, [875–876](#), [878](#)
  - result tree, [875](#)

## ■ Y

Yahoo! Babel Fish, [925](#)

## ■ Z

ZIP API, [995](#)

ZIP Archive, [1000](#)

ZipFile vs. ZipInputStream, [1002](#)

# Learn Java for Android Development



Jeff Friesen

Apress®

## Learn Java for Android Development

Copyright © 2014 by Jeff Friesen

This work is subject to copyright. All rights are reserved by the Publisher, whether the whole or part of the material is concerned, specifically the rights of translation, reprinting, reuse of illustrations, recitation, broadcasting, reproduction on microfilms or in any other physical way, and transmission or information storage and retrieval, electronic adaptation, computer software, or by similar or dissimilar methodology now known or hereafter developed. Exempted from this legal reservation are brief excerpts in connection with reviews or scholarly analysis or material supplied specifically for the purpose of being entered and executed on a computer system, for exclusive use by the purchaser of the work. Duplication of this publication or parts thereof is permitted only under the provisions of the Copyright Law of the Publisher's location, in its current version, and permission for use must always be obtained from Springer. Permissions for use may be obtained through RightsLink at the Copyright Clearance Center. Violations are liable to prosecution under the respective Copyright Law.

ISBN-13 (pbk): 978-1-4302-6454-5

ISBN-13 (electronic): 978-1-4302-6455-2

Trademarked names, logos, and images may appear in this book. Rather than use a trademark symbol with every occurrence of a trademarked name, logo, or image we use the names, logos, and images only in an editorial fashion and to the benefit of the trademark owner, with no intention of infringement of the trademark.

The images of the Android Robot (01 / Android Robot) are reproduced from work created and shared by Google and used according to terms described in the Creative Commons 3.0 Attribution License. Android and all Android and Google-based marks are trademarks or registered trademarks of Google, Inc., in the U.S. and other countries. Apress Media, L.L.C. is not affiliated with Google, Inc., and this book was written without endorsement from Google, Inc.

The use in this publication of trade names, trademarks, service marks, and similar terms, even if they are not identified as such, is not to be taken as an expression of opinion as to whether or not they are subject to proprietary rights.

While the advice and information in this book are believed to be true and accurate at the date of publication, neither the authors nor the editors nor the publisher can accept any legal responsibility for any errors or omissions that may be made. The publisher makes no warranty, express or implied, with respect to the material contained herein.

President and Publisher: Paul Manning

Lead Editor: Steve Anglin

Development Editor: Gary Schwartz, Tom Welsh

Technical Reviewer: Chad Darby

Editorial Board: Steve Anglin, Mark Beckner, Ewan Buckingham, Gary Cornell, Louise Corrigan,

James T. DeWolf, Jonathan Gennick, Jonathan Hassell, Robert Hutchinson, Michelle Lowman,

James Markham, Matthew Moodie, Jeff Olson, Jeffrey Pepper, Douglas Pundick, Ben Renow-Clarke,

Dominic Shakeshaft, Gwenan Spearing, Matt Wade, Steve Weiss

Coordinating Editor: Anamika Panchoo, Jill Balzano

Production Editor: Steve Weiss

Copy Editor: Mary Behr

Compositor: SPi Global

Indexer: SPi Global

Artist: SPi Global

Cover Designer: Anna Ishchenko

Distributed to the book trade worldwide by Springer Science+Business Media New York, 233 Spring Street, 6th Floor, New York, NY 10013. Phone 1-800-SPRINGER, fax (201) 348-4505, e-mail [orders-ny@springer-sbm.com](mailto:orders-ny@springer-sbm.com), or visit [www.springeronline.com](http://www.springeronline.com). Apress Media, LLC is a California LLC and the sole member (owner) is Springer Science + Business Media Finance Inc (SSBM Finance Inc). SSBM Finance Inc is a Delaware corporation.

For information on translations, please e-mail [rights@apress.com](mailto:rights@apress.com), or visit [www.apress.com](http://www.apress.com).

Apress and friends of ED books may be purchased in bulk for academic, corporate, or promotional use. eBook versions and licenses are also available for most titles. For more information, reference our Special Bulk Sales-eBook Licensing web page at [www.apress.com/bulk-sales](http://www.apress.com/bulk-sales).

Any source code or other supplementary materials referenced by the author in this text is available to readers at [www.apress.com](http://www.apress.com). For detailed information about how to locate your book's source code, go to [www.apress.com/source-code/](http://www.apress.com/source-code/).

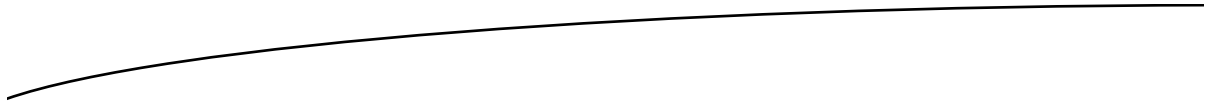

*To you, dear reader!*  
*I hope this book helps you achieve great success.*

---

# Contents

<b>About the Author .....</b>	<b>xxi</b>
<b>About the Technical Reviewer .....</b>	<b>xxiii</b>
<b>Acknowledgments .....</b>	<b>xv</b>
<b>Introduction .....</b>	<b>xxvii</b>
<b>■ Chapter 1: Getting Started with Java .....</b>	<b>1</b>
<b>What Is Java? .....</b>	<b>2</b>
Java Is a Language .....	2
Java Is a Platform .....	4
Java SE, Java EE, and Java ME .....	6
<b>Installing the JDK and Exploring Example Applications .....</b>	<b>7</b>
Hello, World! .....	9
DumpArgs .....	11
EchoText .....	13
<b>Installing and Exploring the Eclipse IDE .....</b>	<b>15</b>
<b>Java Meets Android .....</b>	<b>20</b>
What Is Android? .....	20
History of Android .....	21

---

Android Architecture .....	24
Android Says Hello.....	28
Summary.....	30
<b>■ Chapter 2: Learning Language Fundamentals .....</b>	<b>31</b>
Learning Application Structure.....	31
Learning Comments .....	33
Single-Line Comments .....	33
Multiline Comments.....	33
Javadoc Comments .....	34
Learning Identifiers .....	37
Learning Types .....	38
Primitive Types .....	38
User-Defined Types.....	41
Array Types .....	41
Learning Variables.....	42
Learning Expressions .....	43
Simple Expressions .....	43
Compound Expressions .....	49
Learning Statements.....	70
Assignment Statements .....	71
Decision Statements.....	71
Loop Statements.....	76
Break and Labeled Break Statements .....	81
Continue and Labeled Continue Statements.....	83
Summary.....	86
<b>■ Chapter 3: Discovering Classes and Objects .....</b>	<b>89</b>
Declaring Classes.....	89
Classes and Applications.....	91



---

Constructing Objects .....	92
Default Constructor.....	93
Explicit Constructors.....	93
Objects and Applications .....	97
Encapsulating State and Behaviors.....	98
Representing State via Fields.....	99
Representing Behaviors via Methods .....	107
Hiding Information.....	119
Initializing Classes and Objects.....	124
Class Initializers.....	124
Instance Initializers.....	126
Initialization Order .....	128
Collecting Garbage .....	131
Revisiting Arrays .....	134
Summary.....	139
<b>■ Chapter 4: Discovering Inheritance, Polymorphism, and Interfaces .....</b>	<b>141</b>
Building Class Hierarchies.....	141
Extending Classes .....	142
The Ultimate Superclass.....	148
Composition.....	157
The Trouble with Implementation Inheritance .....	158
Changing Form .....	162
Upcasting and Late Binding.....	163
Abstract Classes and Abstract Methods .....	167
Downcasting and Runtime Type Identification.....	169
Covariant Return Types .....	172
Formalizing Class Interfaces .....	174
Declaring Interfaces .....	174
Implementing Interfaces.....	176
Extending Interfaces.....	180

---

Why Use Interfaces? .....	181
Summary .....	187
<b>■ Chapter 5: Mastering Advanced Language Features, Part 1 .....</b>	<b>189</b>
<b>Mastering Nested Types .....</b>	<b>189</b>
Static Member Classes .....	189
Nonstatic Member Classes .....	193
Anonymous Classes .....	197
Local Classes .....	200
Inner Classes and Memory Leaks .....	202
Interfaces within Classes and Classes within Interfaces .....	203
<b>Mastering Packages .....</b>	<b>205</b>
What Are Packages? .....	206
The Package Statement .....	207
The Import Statement .....	207
Searching for Packages and Types .....	209
Playing with Packages .....	210
Packages and JAR Files .....	215
<b>Mastering Static Imports .....</b>	<b>215</b>
<b>Mastering Exceptions .....</b>	<b>217</b>
What Are Exceptions? .....	218
Representing Exceptions in Source Code .....	218
Throwing Exceptions .....	223
Handling Exceptions .....	226
Performing Cleanup .....	229
Summary .....	234
<b>■ Chapter 6: Mastering Advanced Language Features, Part 2 .....</b>	<b>235</b>
<b>Mastering Assertions .....</b>	<b>235</b>
Declaring Assertions .....	236
Using Assertions .....	237
Avoiding Assertions .....	243
Enabling and Disabling Assertions .....	244

---

<b>Mastering Annotations .....</b>	<b>245</b>
Discovering Annotations .....	245
Declaring Annotation Types and Annotating Source Code .....	248
Processing Annotations .....	253
<b>Mastering Generics .....</b>	<b>255</b>
Collections and the Need for Type Safety .....	255
Generic Types .....	258
Generic Methods.....	267
Arrays and Generics .....	271
<b>Mastering Enums .....</b>	<b>273</b>
The Trouble with Traditional Enumerated Types .....	273
The Enum Alternative .....	275
The Enum Class .....	280
<b>Summary.....</b>	<b>284</b>
<b>■ Chapter 7: Exploring the Basic APIs, Part 1 .....</b>	<b>287</b>
<b>Exploring Math .....</b>	<b>287</b>
StrictMath and strictfp.....	294
<b>Exploring Number and Its Children.....</b>	<b>295</b>
BigDecimal .....	295
BigInteger .....	301
Primitive Type Wrapper Classes.....	305
<b>Exploring String, StringBuffer, and StringBuilder .....</b>	<b>314</b>
String.....	314
StringBuffer and StringBuilder .....	318
<b>Exploring System .....</b>	<b>322</b>
<b>Exploring Threads.....</b>	<b>324</b>
Runnable and Thread.....	325
Synchronization .....	335
Thread-Local Variables .....	352
<b>Summary.....</b>	<b>357</b>

---

<b>Chapter 8: Exploring the Basic APIs, Part 2</b> .....	<b>359</b>
Exploring Random .....	359
Exploring References .....	362
Basic Terminology .....	362
Reference and ReferenceQueue .....	363
SoftReference .....	365
WeakReference .....	365
PhantomReference .....	366
Exploring Reflection .....	368
The Class Entry Point.....	368
Constructor, Field, and Method.....	378
Package.....	383
Array.....	388
Exploring StringTokenizer.....	388
Exploring Timer and TimerTask .....	391
Timer in Depth .....	392
TimerTask in Depth.....	395
Summary.....	399
<b>Chapter 9: Exploring the Collections Framework</b> .....	<b>401</b>
Exploring Collections Framework Fundamentals .....	401
Comparable vs. Comparator .....	402
Iterable and Collection.....	404
Exploring Lists.....	411
ArrayList .....	415
LinkedList.....	416
Exploring Sets .....	419
TreeSet.....	419
HashSet .....	420
EnumSet .....	425
Exploring Sorted Sets.....	428
Exploring Navigable Sets.....	435

---

Exploring Queues .....	438
PriorityQueue .....	440
Exploring Deques .....	443
ArrayDeque .....	447
Exploring Maps .....	448
TreeMap .....	452
HashMap .....	453
IdentityHashMap .....	463
WeakHashMap .....	465
EnumMap .....	467
Exploring Sorted Maps .....	468
Exploring Navigable Maps .....	471
Exploring the Arrays and Collections Utility APIs .....	475
Exploring the Legacy Collection APIs .....	479
Summary .....	486
<b>Chapter 10: Exploring the Concurrency Utilities.....</b>	<b>487</b>
Introducing the Concurrency Utilities .....	487
Exploring Executors .....	488
Exploring Synchronizers .....	497
Countdown Latches .....	497
Cyclic Barriers .....	500
Exchangers .....	505
Semaphores .....	509
Exploring the Concurrent Collections .....	515
Demonstrating BlockingQueue and ArrayBlockingQueue .....	516
Learning More About ConcurrentHashMap .....	518
Exploring the Locking Framework .....	518
Lock .....	519
ReentrantLock .....	521
Condition .....	524

---

ReadWriteLock .....	529
ReentrantReadWriteLock .....	529
Exploring Atomic Variables .....	533
Improving Performance with the Concurrency Utilities .....	535
Summary .....	538
<b>■ Chapter 11: Performing Classic I/O .....</b>	<b>539</b>
Working with the File API .....	539
Constructing File Instances .....	540
Learning About Stored Abstract Pathnames .....	542
Learning About a Pathname's File or Directory .....	545
Obtaining Disk Space Information .....	546
Listing Directories .....	548
Creating and Manipulating Files and Directories .....	550
Setting and Getting Permissions .....	552
Exploring Miscellaneous Capabilities .....	554
Working with the RandomAccessFile API .....	556
Working with Streams .....	567
Stream Classes Overview .....	568
OutputStream and InputStream .....	569
ByteArrayOutputStream and ByteArrayInputStream .....	572
FileOutputStream and FileInputStream .....	573
PipedOutputStream and PipedInputStream .....	576
FilterOutputStream and FilterInputStream .....	579
BufferedOutputStream and BufferedInputStream .....	587
DataOutputStream and DataInputStream .....	588
Object Serialization and Deserialization .....	590
PrintStream .....	604
Standard I/O Revisited .....	606
Working with Writers and Readers .....	607
Writer and Reader Classes Overview .....	608
Writer and Reader .....	610

---

OutputStreamWriter and InputStreamReader .....	611
FileWriter and FileReader .....	612
Summary .....	620
■ <b>Chapter 12: Accessing Networks</b> .....	<b>621</b>
Accessing Networks via Sockets .....	622
Socket Addresses .....	624
Socket Options.....	625
Socket and ServerSocket .....	626
DatagramSocket and MulticastSocket .....	632
Accessing Networks via URLs .....	639
URL and URLConnection .....	639
URLEncoder and URLDecoder.....	643
URI .....	645
Accessing Network Interfaces and Interface Addresses.....	652
Managing Cookies.....	657
Summary.....	662
■ <b>Chapter 13: Migrating to New I/O</b> .....	<b>665</b>
Working with Buffers.....	666
Buffer and Its Children.....	666
Buffers in Depth.....	670
Working with Channels .....	681
Channel and Its Children.....	681
Channels in Depth .....	686
Working with Selectors .....	723
Selector Fundamentals.....	724
Selector Demonstration .....	728
Working with Regular Expressions.....	732
Pattern, PatternSyntaxException, and Matcher .....	732
Character Classes.....	737
Capturing Groups.....	738
Boundary Matchers and Zero-Length Matches .....	739

---

Quantifiers .....	740
Practical Regular Expressions .....	743
<b>Working with Charsets .....</b>	<b>743</b>
A Brief Review of the Fundamentals .....	743
Working with Charsets .....	744
Charsets and the String Class .....	750
<b>Working with Formatter and Scanner .....</b>	<b>751</b>
Working with Formatter.....	752
Working with Scanner .....	756
<b>Summary.....</b>	<b>761</b>
<b>■ Chapter 14: Accessing Databases .....</b>	<b>763</b>
<b>Introducing Java DB .....</b>	<b>764</b>
Java DB Installation and Configuration.....	766
Java DB Demos.....	767
Java DB Command-Line Tools .....	769
<b>Introducing SQLite.....</b>	<b>772</b>
<b>Accessing Databases via JDBC .....</b>	<b>774</b>
Data Sources, Drivers, and Connections.....	774
Exceptions .....	777
Statements .....	781
Metadata .....	794
<b>Summary.....</b>	<b>801</b>
<b>■ Chapter 15: Parsing, Creating, and Transforming XML Documents.....</b>	<b>803</b>
<b>What Is XML? .....</b>	<b>803</b>
XML Declaration .....	805
Elements and Attributes .....	806
Character References and CDATA Sections.....	808
Namespaces.....	809
Comment and Processing Instructions.....	813
Well-Formed Documents.....	814
Valid Documents.....	814



---

Parsing XML Documents with SAX.....	824
Exploring the SAX API.....	825
Demonstrating the SAX API.....	831
Creating a Custom Entity Resolver.....	840
Parsing and Creating XML Documents with DOM.....	843
A Tree of Nodes.....	843
Exploring the DOM API.....	845
Parsing XML Documents with XMLPULL V1.....	855
Selecting XML Document Nodes with XPath.....	859
XPath Language Primer.....	859
XPath and DOM.....	863
Advanced XPath.....	868
Transforming XML Documents with XSLT.....	875
Exploring the XSLT API.....	875
Demonstrating the XSLT API.....	878
Summary.....	884
<b>Chapter 16: Focusing on Odds and Ends.....</b>	<b>885</b>
Focusing on Additional Language Features.....	885
Numeric Literal Enhancements.....	886
Switch-on-String.....	886
Diamond Operator.....	887
Multicatch.....	887
Automatic Resource Management.....	888
Focusing on Classloaders.....	891
Kinds of Classloaders.....	891
Class-Loading Mechanics.....	892
Playing with Classloaders.....	893
Classloader Difficulties.....	897
Classloaders and Resources.....	899
Focusing on Console.....	902

---

Focusing on Design Patterns.....	905
Understanding Strategy.....	906
Implementing Strategy .....	906
Focusing on Double Brace Initialization .....	909
Focusing on Fluent Interfaces .....	910
Focusing on Immutability .....	911
Focusing on Internationalization .....	914
Locales .....	915
Resource Bundles.....	916
Break Iterators.....	935
Collators .....	939
Dates, Time Zones, and Calendars.....	941
Formatters.....	948
Focusing on Logging .....	958
Logging API Overview .....	959
A Hierarchy of Loggers .....	960
Logging Messages.....	962
Filtering LogRecords.....	968
Handlers and Formatters.....	971
LogManager and Configuration .....	974
ErrorManager.....	977
Focusing on Preferences.....	981
Exploring Preferences .....	982
Focusing on Runtime and Process .....	986
Focusing on the Java Native Interface .....	990
Creating a Hybrid Library.....	990
Testing the Hybrid Library.....	994
Focusing on ZIP and JAR.....	995
Focusing on the ZIP API .....	995
Focusing on the JAR API.....	1003
Summary.....	1010

---

■ <b>Appendix A: Solutions to Exercises</b> .....	<b>1015</b>
Chapter 1: Getting Started with Java .....	1015
Chapter 2: Learning Language Fundamentals.....	1017
Chapter 3: Discovering Classes and Objects.....	1020
Chapter 4: Discovering Inheritance, Polymorphism, and Interfaces .....	1026
Chapter 5: Mastering Advanced Language Features, Part 1 .....	1034
Chapter 6: Mastering Advanced Language Features, Part 2 .....	1041
Chapter 7: Exploring the Basic APIs, Part 1 .....	1046
Chapter 8: Exploring the Basic APIs, Part 2 .....	1054
Chapter 9: Exploring the Collections Framework .....	1059
Chapter 10: Exploring the Concurrency Utilities .....	1065
Chapter 11: Performing Classic I/O .....	1073
Chapter 12: Accessing Networks.....	1083
Chapter 13: Migrating to New I/O .....	1088
Chapter 14: Accessing Databases .....	1096
Chapter 15: Parsing, Creating, and Transforming XML Documents .....	1100
Chapter 16: Focusing on Odds and Ends.....	1116
■ <b>Appendix B: Four of a Kind</b> .....	<b>1127</b>
Understanding Four of a Kind.....	1127
Modeling Four of a Kind in Pseudocode.....	1128
Converting Pseudocode to Java Code .....	1129
Compiling, Running, and Distributing FourOfAKind .....	1145
<b>Index</b> .....	<b>1149</b>

---

# About the Author



**Jeff Friesen** is a freelance tutor, author, and software developer with an emphasis on Java, Android, and HTML5. In addition to writing this book and its two predecessors, Jeff has written numerous articles on Java and other technologies for JavaWorld ([www.javaworld.com](http://www.javaworld.com)), informIT ([www.informit.com](http://www.informit.com)), java.net, SitePoint ([www.sitepoint.com](http://www.sitepoint.com)), and others. Jeff can be contacted via his web site at [tutortutor.ca](http://tutortutor.ca).

---

# About the Technical Reviewer



**Chád Darby** is an author, instructor, and speaker in the Java development world. As a recognized authority on Java applications and architectures, he has presented technical sessions at software development conferences worldwide (U.S., U.K., India, Russia, and Australia). In his 15 years as a professional software architect, he's had the opportunity to work for Blue Cross/Blue Shield, Merck, Boeing, Red Hat, and a handful of startup companies.

Chád is a contributing author to several Java books, including *Professional Java E-Commerce* (Wrox Press), *Beginning Java Networking* (Wrox Press), and *XML and Web Services Unleashed* (Sams Publishing). Chád has Java certifications from Sun Microsystems and IBM. He holds a B.S. in Computer Science from Carnegie Mellon University.

Visit Chád's blog at [www.luv2code.com](http://www.luv2code.com) to view his free video tutorials on Java. You can also follow him on Twitter at [@darbyluvs2code](https://twitter.com/darbyluvs2code).

---

# Acknowledgments

I would like to thank Steve Anglin for contacting me to write this book, Jill Balzano and Anamika Panchoo for guiding me through the various aspects of this project, Tom Welsh and Gary Schwartz for helping me with the development of my chapters, and Chad Darby for his diligence in catching various flaws that would otherwise have made it into this book.